

PSEG 2024  
Submission of Supplemental Projects for  
Inclusion in the Local Plan

**Need Number:** PSEG-2023-0008

**Process Stage:** Submission of Supplemental Project for inclusion in the Local Plan 02/07/2024

**Previously Presented:**

- Need Meeting 07/20/2023
- Solutions Meeting 08/17/2023

**Supplemental Project Driver:**

- Customer Service
- Equipment Material Condition, Performance and Risk

**Specific Assumption Reference:**

[PSE&G 2023 Annual Assumptions](#)

- Localized Load Growth & Contingency Overloads
- Equipment Reliability and Condition Assessment

**Problem Statement:**

- East Rutherford is a station in the Bergen county area with no additional station capacity.
  - East Rutherford serves over 17,600 customers with a peak load of over 70.9MVA in 2021.
  - The actual station capacity is 62.5MVA. Contingency overload is 113%.
- The Van Winkle Substation building is over 80 years old, is in poor condition, and is not in compliance with today's NJ UCC requirements.
  - Van Winkle serves over 5,400 customers.

**Model:** 2021 Series 2026 Summer RTEP 50/50

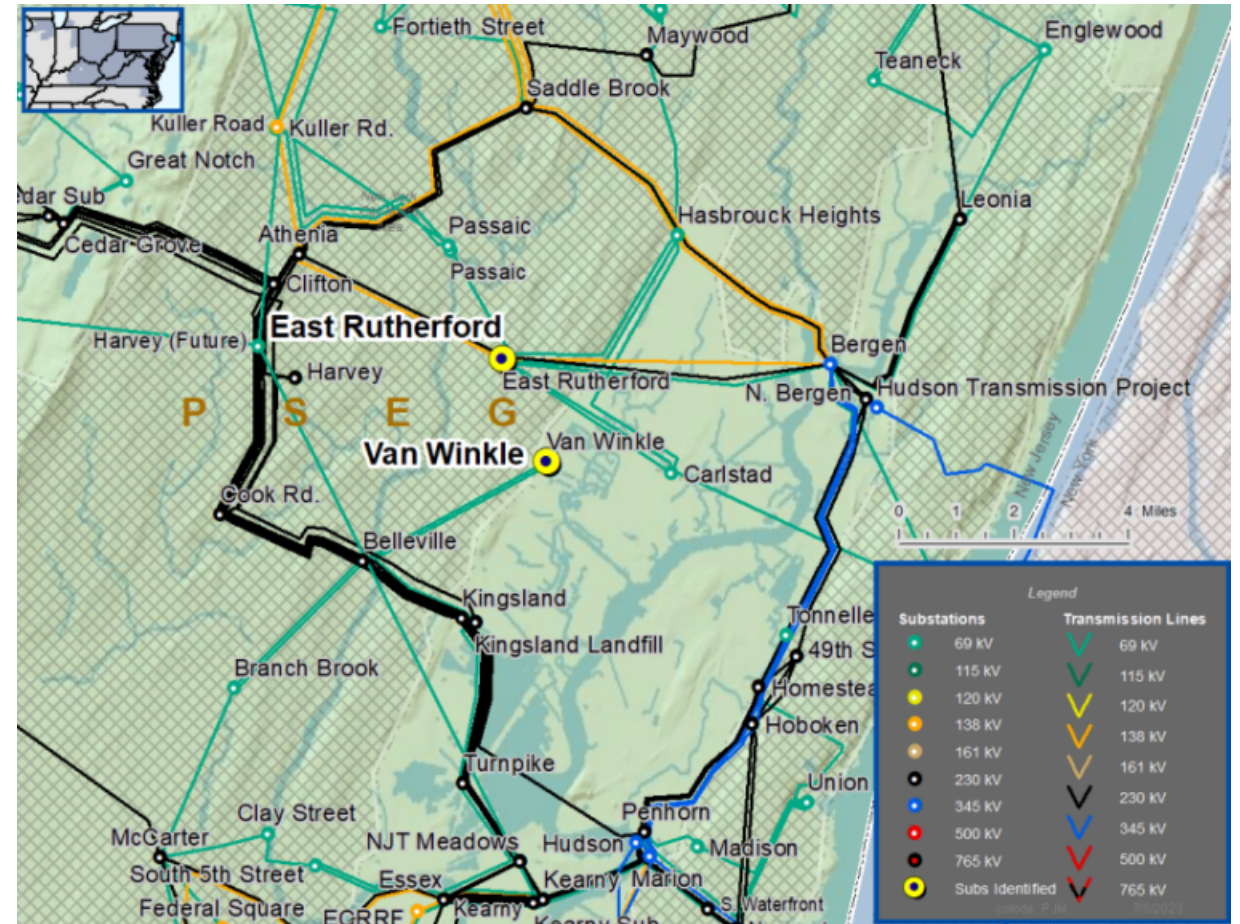



# PSEG Transmission Zone M-3 Process East Rutherford Area

**Need Number:** PSEG-2023-0008

**Process Stage:** Submission of Supplemental Project for inclusion in the Local Plan 02/07/2024

**Selected Solution:**

- Upgrade Van Winkle to a 69-13kV substation.
  - To ensure continuity of service, the project requires a temporary 69kV contingency during the construction sequence.
  - Remove existing transformers and associated equipment at Van Winkle.
  - Install two (2) 69-13kV transformers and associated equipment.

**Estimated Cost:** \$32.5M

**Projected In-Service:** 06/2027

**Supplemental Project ID:** s3010

**Project Status:** Engineering and Planning

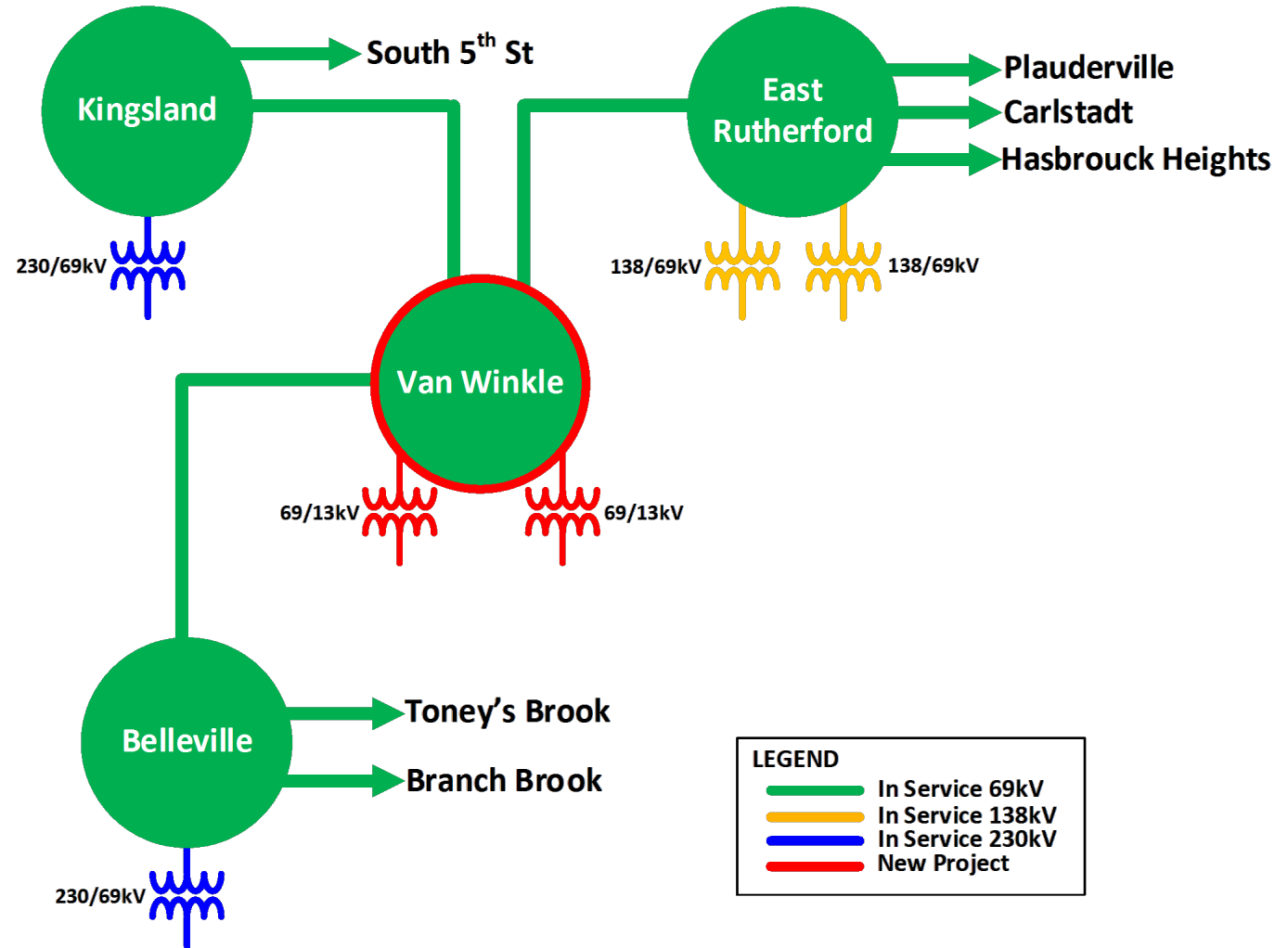



**Need Number:** PSEG-2023-0005

**Process Stage:** Submission of Supplemental Project for inclusion in the Local Plan 02/07/2024

**Previously Presented:**

- Need Meeting 05/18/2023
- Solutions Meeting 07/20/2023

**Supplemental Project Driver:**

- Equipment Material Condition, Performance and Risk

**Specific Assumption Reference:**

[PSE&G 2023 Annual Assumptions](#)

- Equipment Criticality, Consequence of Failure

**Problem Statement:**

- The cable connecting Newark and Bayonne 69kV networks is a high pressure fluid-filled circuit and is an environmental risk. The high pressure fluid-filled line was constructed in 1963. The line length totals to 2.3 miles with approximately 4800 feet underwater in the Newark Bay.
- The circuit contains over 23,000 gallons of dielectric fluid. There is a potential risk of an un-controlled leak of up to 56% of that fluid into Newark Bay.

**Model:** 2022 Series 2027 Summer RTEP 50/50







# PSE&G Transmission Zone M-3 Process Newark Bay Area

**Need Number:** PSEG-2023-0005

**Process Stage:** Submission of Supplemental Project for inclusion in the Local Plan 02/07/2024

**Selected Solution:**

- Replace the G-709 High Pressure Fluid Filled (HPFF) cable with Extruded Pipe (EP) cable.
  - Replace 2.3 miles of HPFF cable with EP cable.
  - Re-use the existing G-709 pipe and route for the cable replacement.
  - Modify terminal equipment at PVSC and Bayonne stations to accommodate the EP cables
  - At Bayonne station, de-commission and remove the oil pumping equipment including pumping plant, tank, controls, and piping associated with the cable.

**Estimated Cost:** \$25.6M

**Projected In-Service:** 12/2025

**Supplemental Project ID:** s3007

**Project Status:** Engineering and Planning

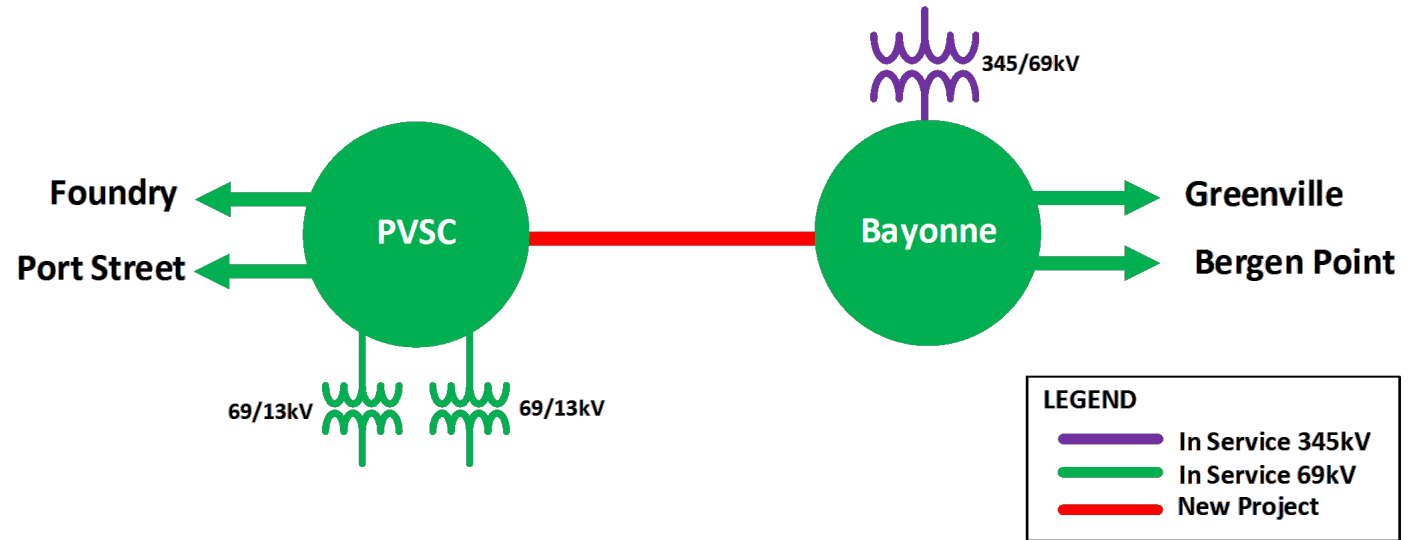

**Need Number:** PSEG-2023-0006

**Process Stage:** Submission of Supplemental Project for inclusion in the Local Plan 02/07/2024

**Previously Presented:**

- Needs Meeting 7/11/2023
- Solutions Meeting 9/05/2029

**Supplemental Project Driver:**

- Customer Service

**Specific Assumption Reference:**

[PSE&G 2023 Annual Assumptions](#)

- Localized Load Growth & Contingency Overloads

**Problem Statement:**

- Meadow Road Substation is a station in the Edison area with no additional station capacity.
  - Meadow Road serves over 14,000 customers with a peak load of over 73.9 MVA in 2022.
  - The actual station capacity is 59.4 MVA. Contingency overload is 124%.

- **Model:** 2022 Series 2027 Summer RTEP 50/50

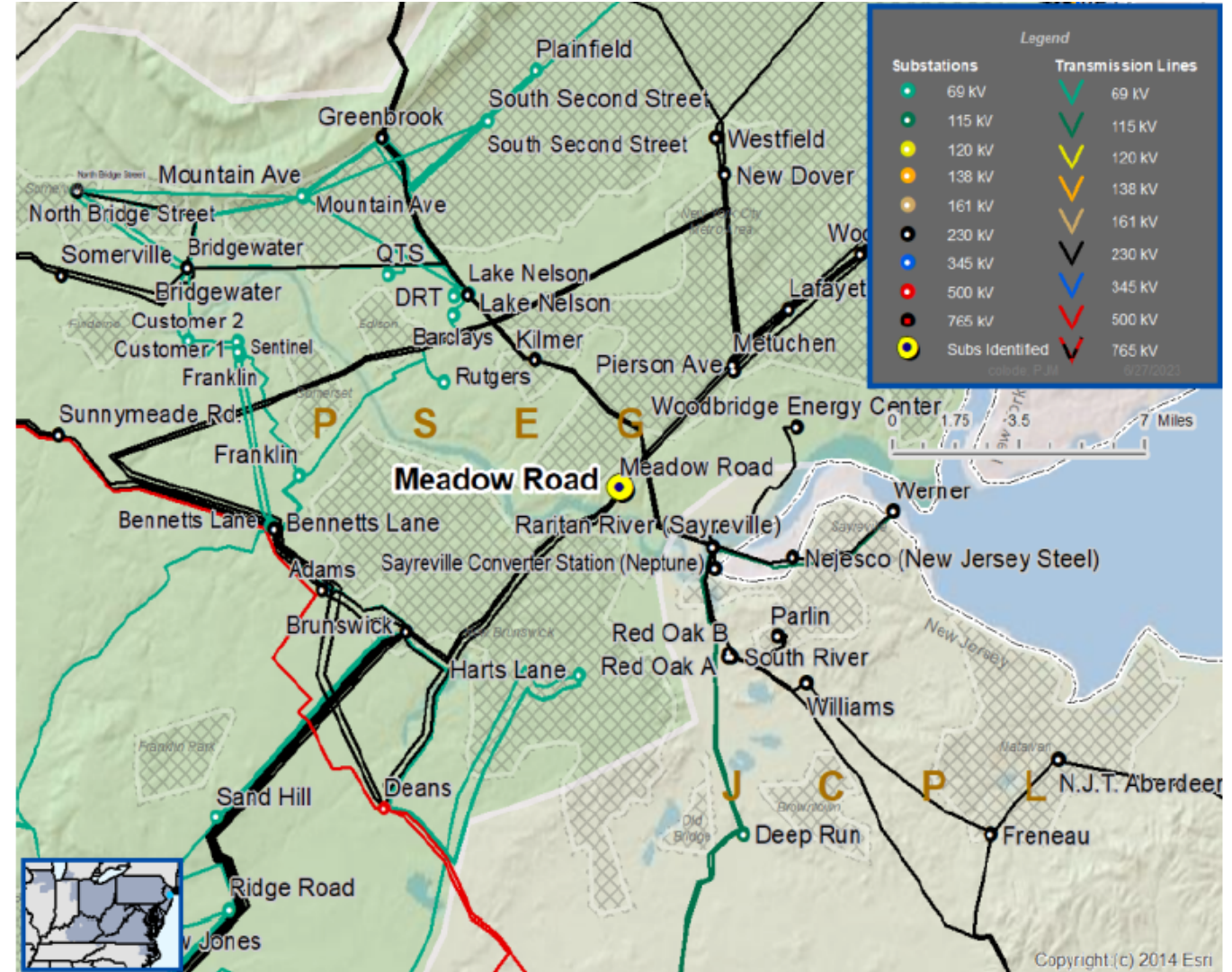



**Need Number:** PSEG-2023-0006

**Process Stage:** Submission of Supplemental Project for inclusion in the Local Plan 02/07/2024

**Selected Solution:**

- Construct a 230-13kV Substation at PSEG property adjacent to Meadow Road substation.
  - Construct a 230kV substation.
  - Install two (2) 230-13kV transformers.
  - Resolves contingency overload at Meadow Road substation.

**Estimated Cost:** \$56.1M

**Projected In-Service:** 05/2028

**Supplemental Project ID:** s3008

**Project Status:** Engineering and Planning

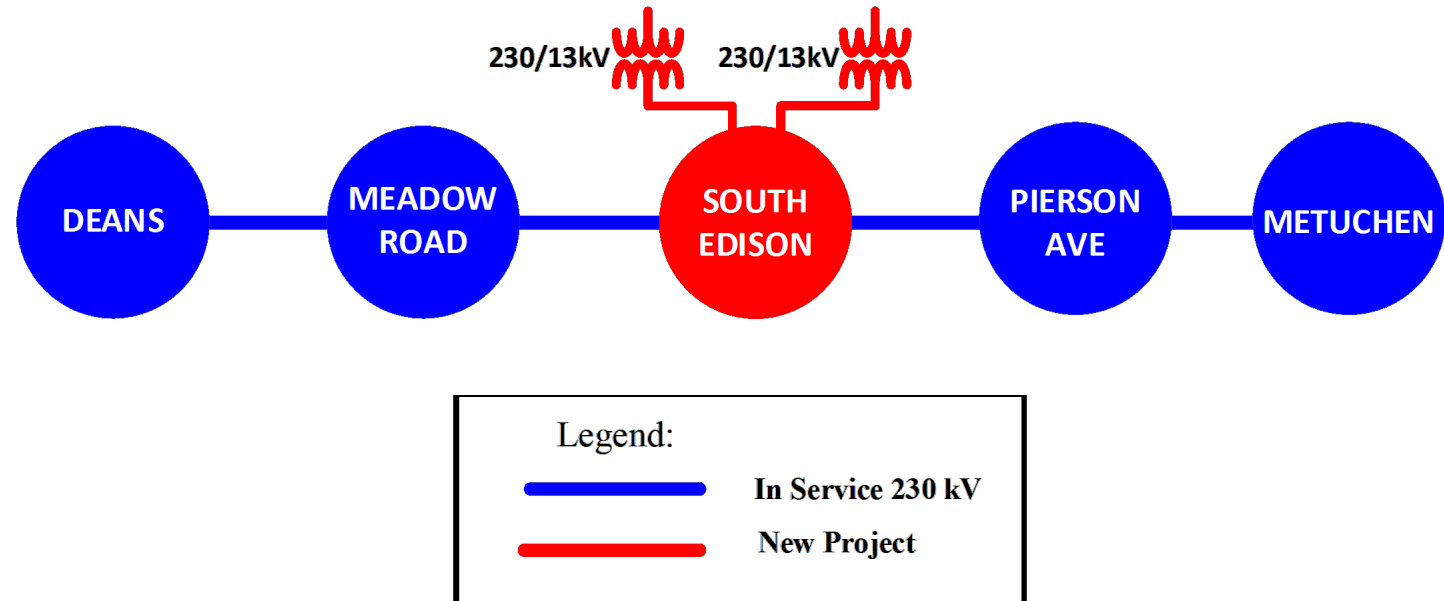





**Need Number:** PSEG-2023-0007

**Process Stage:** Submission of Supplemental Project for inclusion in the Local Plan  
02/07/2024

**Previously Presented:**

- Needs Meeting 7/11/2023
- Solutions Meeting 9/05/2029

**Supplemental Project Driver:**

- Customer Service
- Equipment Material Condition, Performance and Risk

**Specific Assumption Reference:**

[PSE&G 2023 Annual Assumptions](#)

- Localized Load Growth & Contingency Overloads
- Equipment Reliability and Condition Assessment
- Asset Risk Model

**Problem Statement:**

- Pierson Ave. Substation is a station in the Perth Amboy area with no additional station capacity.
  - Pierson Ave. serves over 14,600 customers with a peak load of over 75.42 MVA in 2021.
  - The actual station capacity is 61.17MVA. Contingency overload is 123.3%.
- Keasbey substation is a station in the Perth Amboy Area with equipment and building condition issues.
  - Station equipment at Keasbey is in poor condition and will need to be addressed.
  - Keasbey Substation building is nearly 100 years old, is in poor condition, and is not in compliance with today's NJ UCC requirements.

**Model:** 2022 Series 2027 Summer RTEP 50/50

# PSE&G Transmission Zone M-3 Process Perth Amboy Area

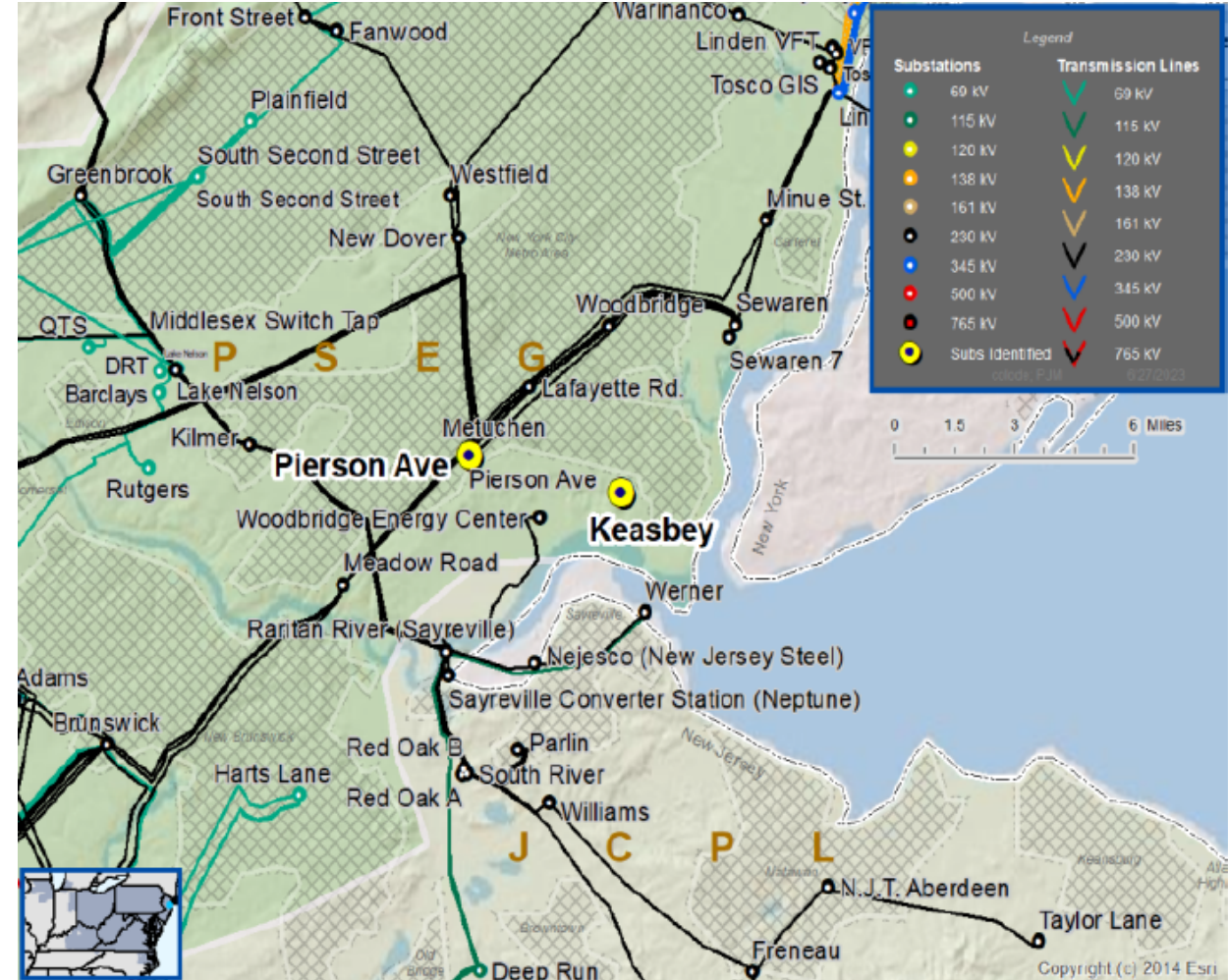



# PSE&G Transmission Zone M-3 Process Perth Amboy Area

**Need Number:** PSEG-2023-0007

**Process Stage:** Submission of Supplemental Project for inclusion in the Local Plan 02/07/2024

**Selected Solution:**

- Construct a new 69/13kV station on PSE&G owned adjacent property to Keasbey station.
  - Build a new 69kV line to Rahway station.
  - Build a new 69kV line to Blair Rd.
  - Install one (1) 230/69kV transformer at South Edison.
  - Build a new 69kV line to South Edison.

**Estimated Cost:** \$220.68M

**Projected In-Service:** 12/2028

**Supplemental Project ID:** s3009

**Project Status:** Engineering and Planning

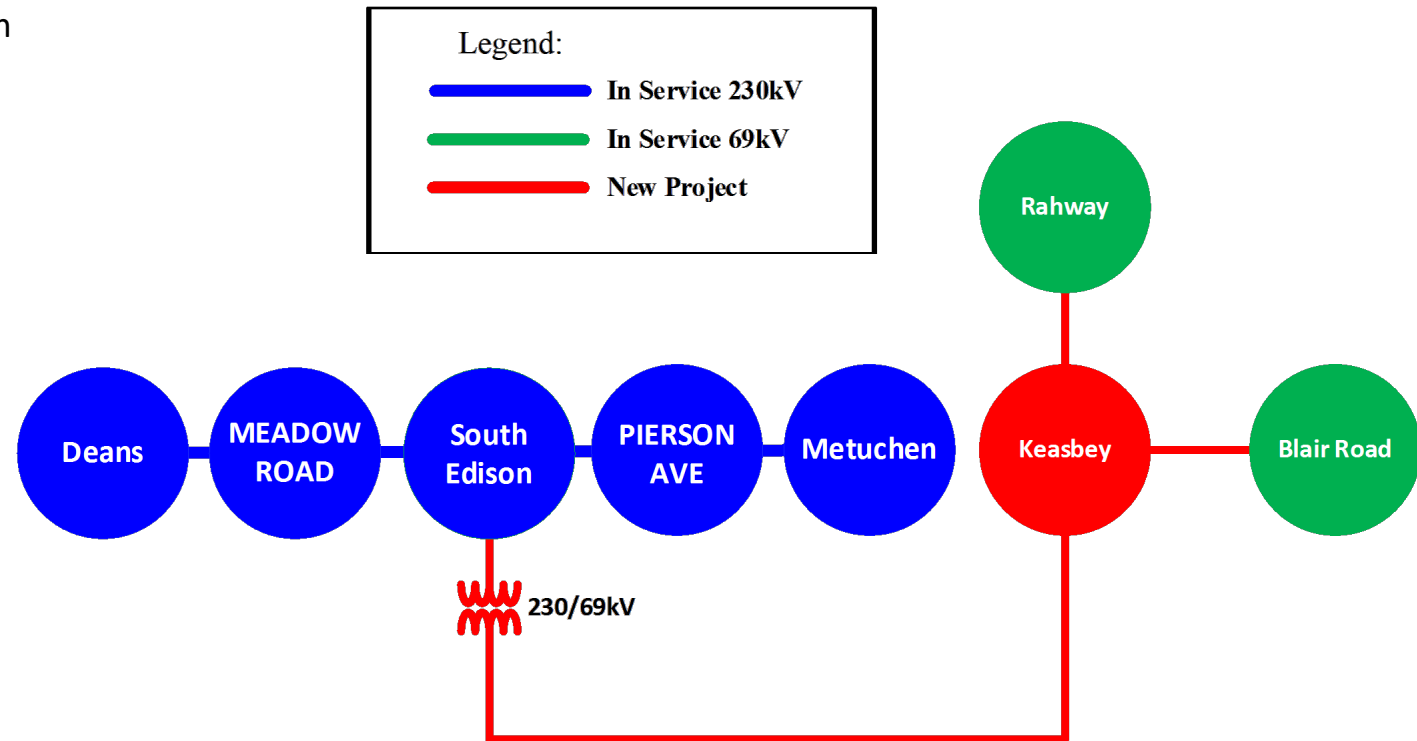





# PSE&G Transmission Zone M-3 Process Harlingen Area

**Need Number:** PSEG-2023-0009

**Process Stage:** Submission of Supplemental Project for inclusion in the Local Plan 02/26/2024

**Previously Presented:**

- Need Meeting 09/05/2023
- Solutions Meeting 10/31/2023

**Supplemental Project Driver:**

- Customer Service

**Specific Assumption Reference:**

[PSE&G 2023 Annual Assumptions](#)

- Localized Load Growth & Contingency Overloads

**Problem Statement:**

- Sunnymeade Substation is a station in the Hillsborough area with no additional station capacity.
  - Sunnymeade serves over 21,400 customers with a peak load of over 63.4 MVA in 2021.
  - The actual station capacity is 61.43MVA. Contingency overload is 103.2%.
- Mount Rose Substation is a station in the Mount Rose area with no additional station capacity.
  - Mount Rose serves over 11,800 customers with a peak load of over 65.0 MVA in 2021.
  - The actual station capacity is 61.47MVA. Contingency overload is 105.7%.

**Model:** 2022 Series 2027 Summer RTEP 50/50

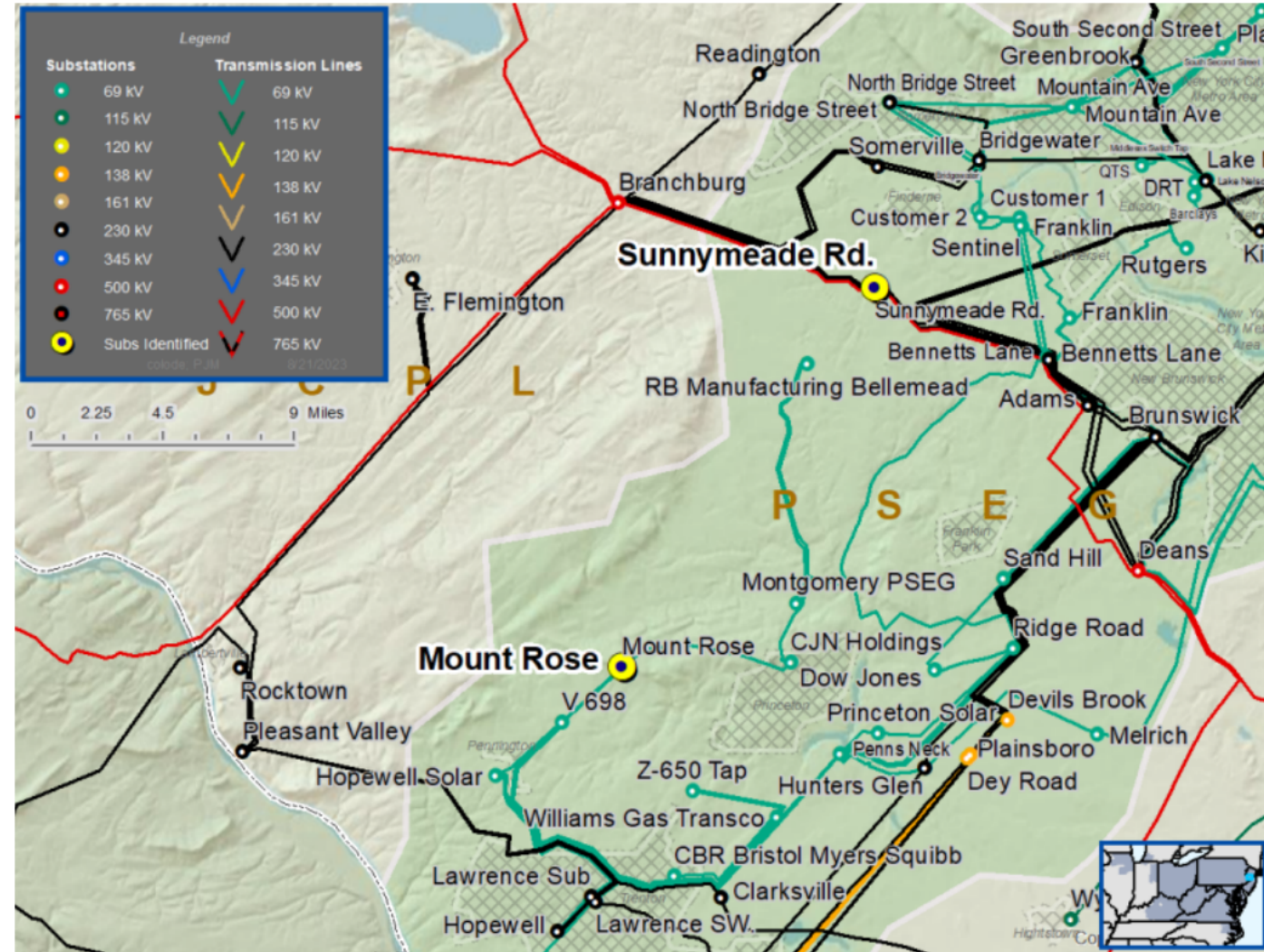





# PSEG Transmission Zone M-3 Process Harlingen Area

**Need Number:** PSEG-2023-0009

**Process Stage:** Submission of Supplemental Project for inclusion in the Local Plan 02/26/2024

**Selected Solution:**

- Construct a new 69-13kV substation in the Harlingen area
  - Construct new 69-13kV station on new property
  - Install two (2) 69-13kV transformers
  - Cut and loop the Bennetts Lane-Montgomery 69kV line into the new substation
  - Cut and loop the Montgomery-Customer Sub 69kV line into the new substation
  - Resolves contingency overload at Sunnymead and Mount Rose substation
- Construct a second 230-69kV transformer at the Bennetts Lane substation
  - Install one (1) 230-69kV transformer
  - Modify 230kV bus at Bennetts Lane
  - Modify 69kV bus at Bennetts Lane

**Estimated Cost:** \$105.1M

**Projected In-Service:** 12/2029

**Supplemental Project ID:** s3090

**Project Status:** Engineering and Planning

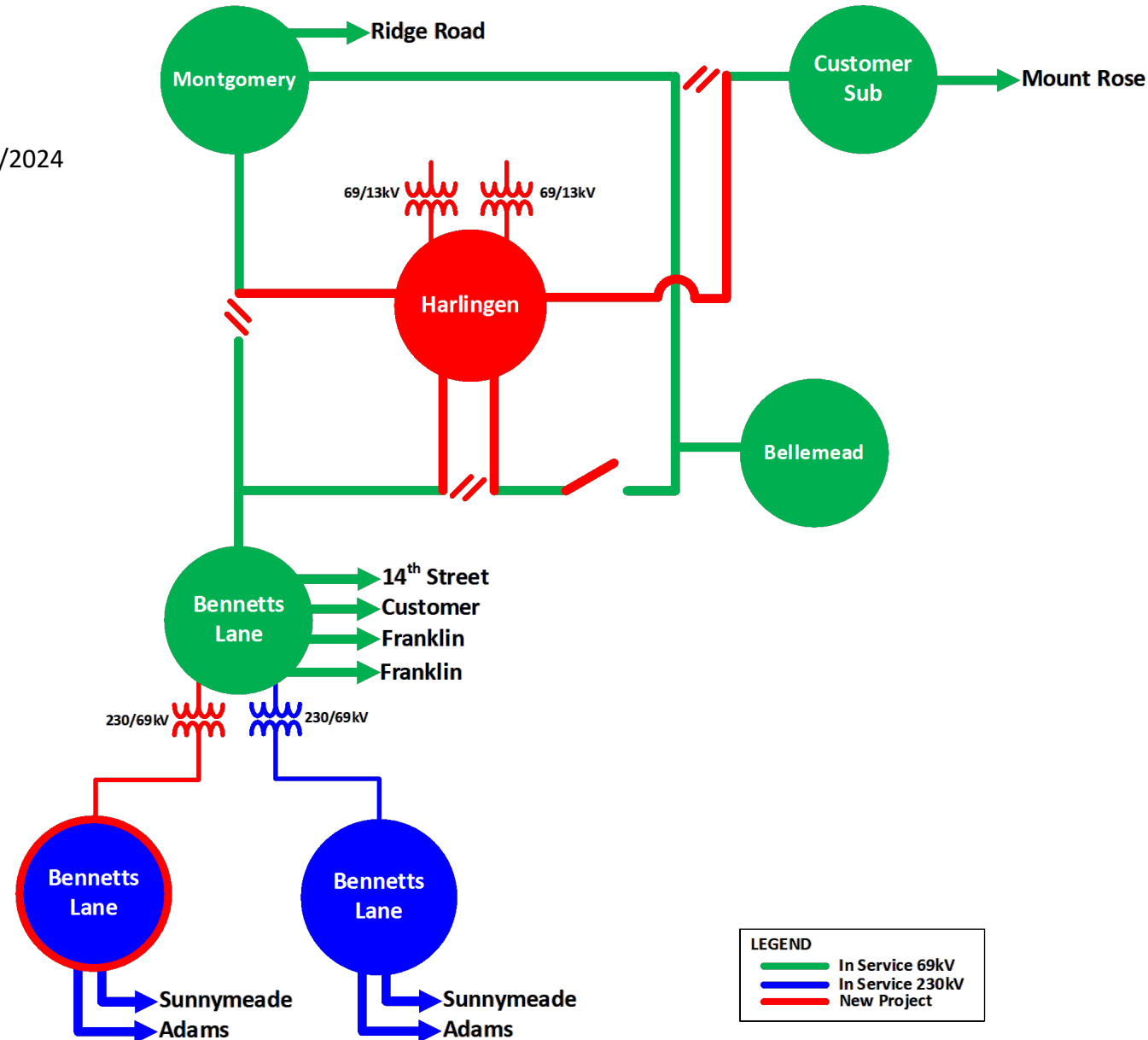

**Need Number:** PSEG-2023-0012

**Process Stage:** Submission of Supplemental Project for inclusion in the Local Plan 03/15/2024

**Previously Presented:**

- Need Meeting 11/16/2023
- Solutions Meeting 01/18/2024

**Supplemental Project Driver:**

- Customer Service

**Specific Assumption Reference:**

[PSE&G 2023 Annual Assumptions](#)

- Localized Load Growth & Contingency Overloads

**Problem Statement:**

- South Second Street Substation is a station in the Plainfield area with no additional station capacity.
  - South Second Street serves about 12,000 customers with a projected load of 66MVA in 2024.
  - The actual station capacity is 60.3MVA. Projected contingency overload is 109.5%.

**Model:** 2022 Series 2027 Summer RTEP 50/50

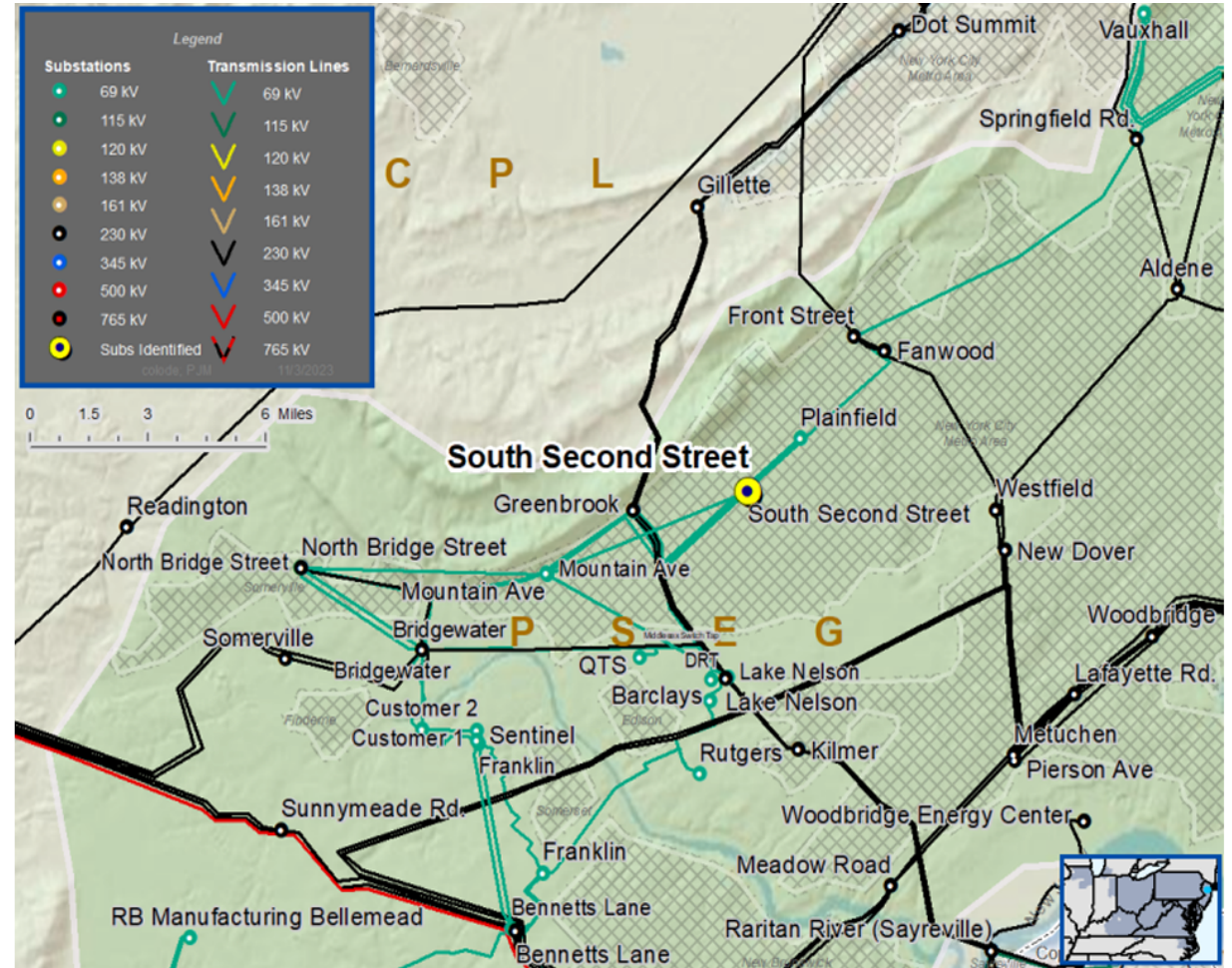



**Need Number:** PSEG-2023-0012

**Process Stage:** Submission of Supplemental Project for inclusion in the Local Plan 03/15/2024

**Selected Solution:**

- Construct a third transformer at existing South Second St. Station
  - Install one (1) 69/13kV transformer.

**Estimated Cost:** \$6.5M

**Projected In-Service:** 12/2029

**Supplemental Project ID:** s3184.1

**Project Status:** Engineering and Planning

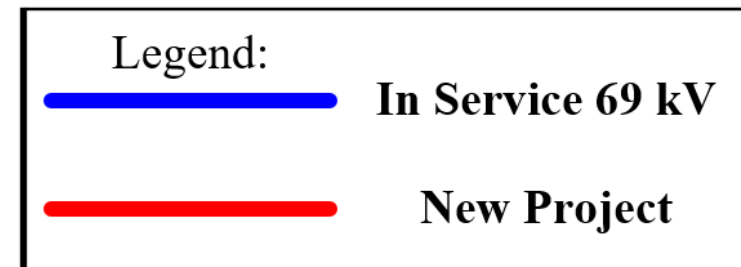
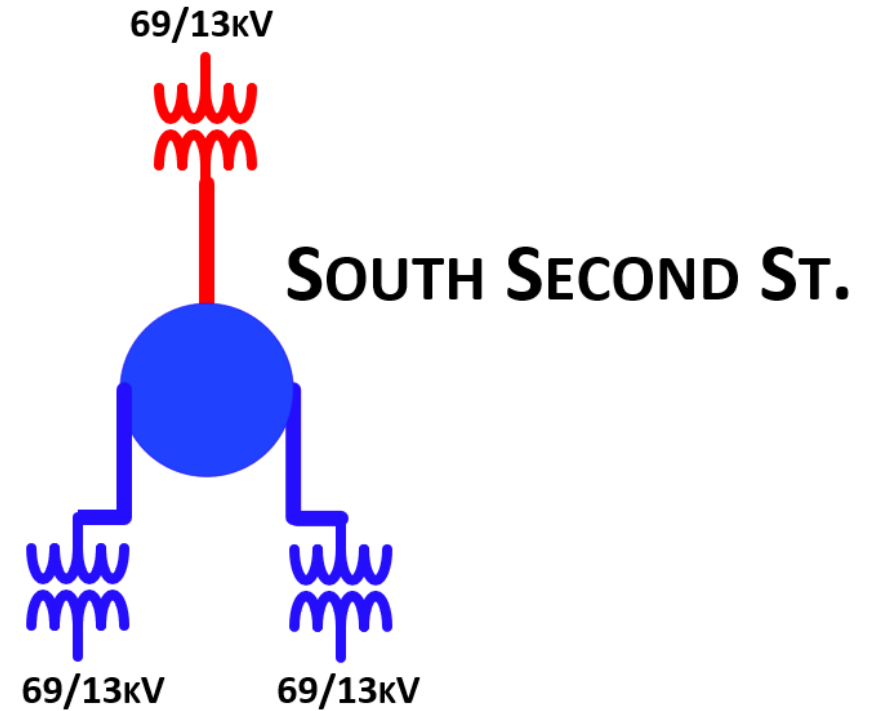





# PSE&G Transmission Zone M-3 Process Deans – E Windsor – New Freedom 500kV Communications

**Need Number:** PSEG-2023-0013

**Process Stage:** Submission of Supplemental Project for inclusion in the Local Plan 05/13/2024

**Previously Presented:**

- Need Meeting 12/5/2023
- Solutions Meeting 2/6/2024

**Supplemental Project Driver:**

- Equipment Material Condition, Performance and Risk
- Operational Flexibility and Efficiency

**Specific Assumption Reference:**

[PSE&G 2023 Annual Assumptions](#)

- Equipment Criticality, Consequence of Failure

**Problem Statement:**

Existing communications equipment is currently power line carrier (PLC) on Deans – E Windsor and E Windsor – New Freedom 500kV. PLC equipment is affected during severe weather.

PJM Relay Subcommittee issued recommendations effective 4/17/2014 concerning Directional Comparison Blocking (DCB).

The tolerance for overtrips may be unacceptable when the stability of large generating units is adversely affected.

A protection scheme more secure than DCB is recommended in cases where stability concerns are present.

**Model:** 2023 Series 2028 Summer RTEP 50/50

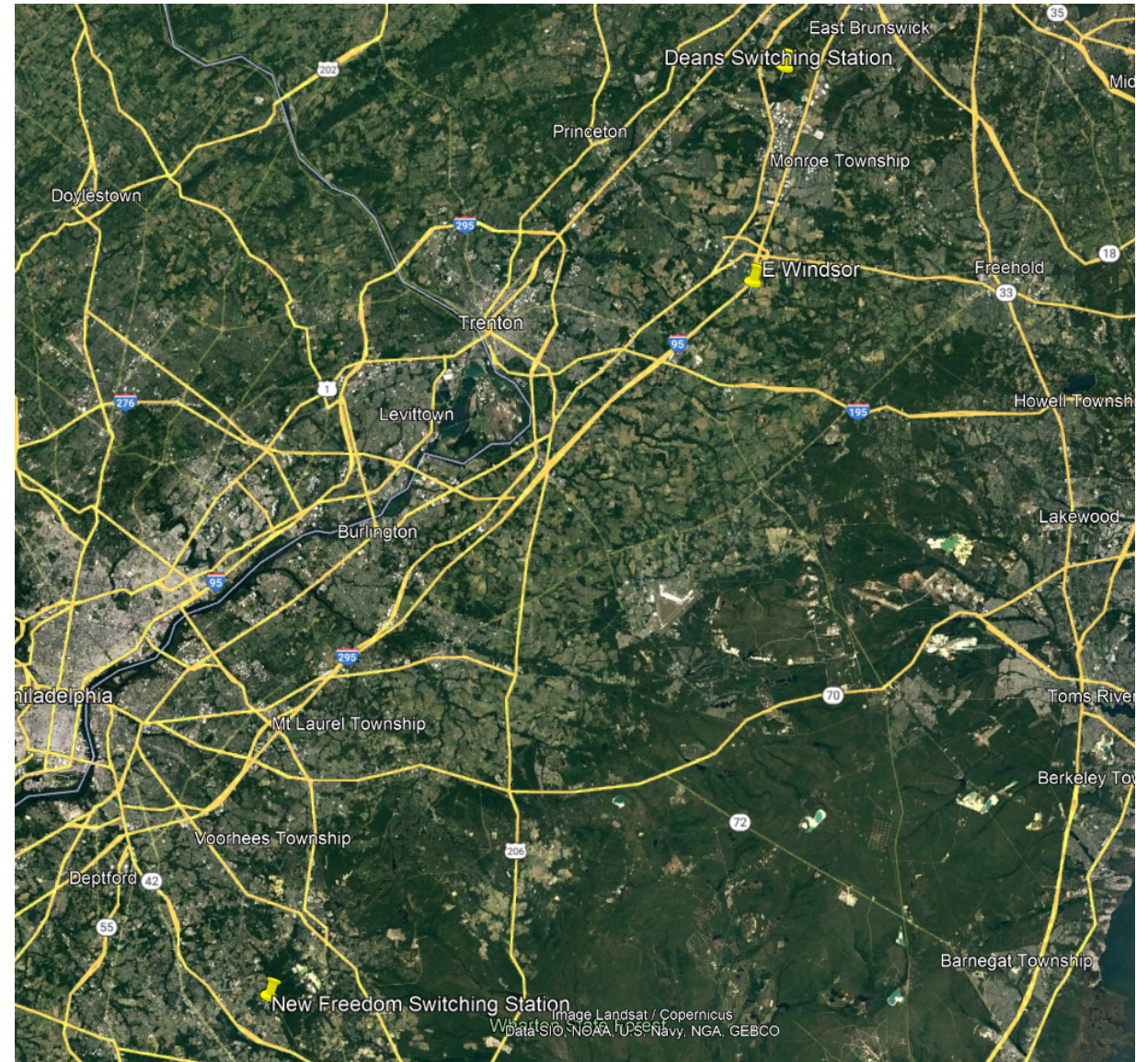



# PSE&G Transmission Zone M-3 Process Deans – E Windsor – New Freedom 500kV Communications

**Need Number:** PSEG-2023-0013

**Process Stage:** Submission of Supplemental Project for inclusion in the Local Plan 05/13/2024

**Selected Solution:**

- Construct new fiber path between New Freedom – E Windsor - Deans
  - Replace 53 miles of static wire on 5038 (New Freedom – E Windsor) and 5022 (E Windsor - Deans)
  - Upgrade line relay equipment and remove Power Line Carrier (PLC) equipment

**Estimated Cost:** \$39.2M

**Projected In-Service:** 12/2025 (5022/Deans) & 12/2026 (5038/N Freedom)

**Supplemental Project ID:** s3276.1

**Project Status:** Engineering and Planning

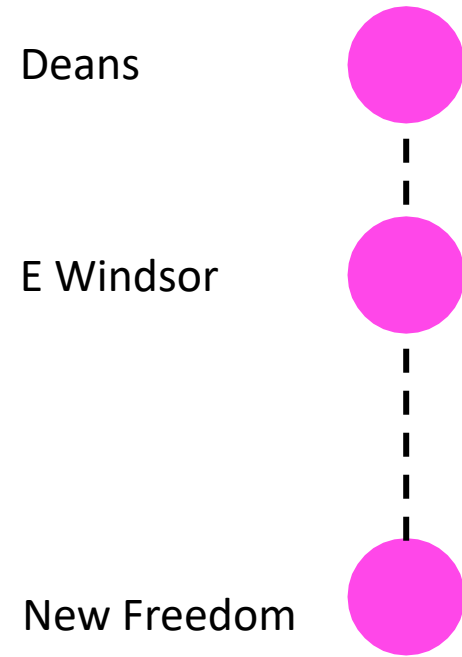

(This project will replace Project s0473)





# PSE&G Transmission Zone M-3 Process Newark Bay Cogen

**Need Number:** PSEG-2023-0010

**Process Stage:** Submission of Supplemental Project for inclusion in the Local Plan 05/13/2024

**Previously Presented:**

- Need Meeting 10/31/2023
- Solutions Meeting 3/5/2024

**Supplemental Project Driver:**

- Equipment Material Condition, Performance and Risk

**Specific Assumption Reference:**

[PSE&G 2023 Annual Assumptions](#)

- Equipment Criticality, Consequence of Failure

**Problem Statement:**

A high pressure fluid-filled transmission circuit constructed as a dedicated feed to a cogeneration facility to allow for generation export is now subject to obsolescence due to the retirement of the cogeneration facility. The high pressure fluid-filled transmission circuit currently provides no transmission system benefit and presents potential environmental impact risks.

**Model:** 2023 Series 2028 Summer RTEP 50/50







**Need Number:** PSEG-2023-0010

**Process Stage:** Submission of Supplemental Project for inclusion in the Local Plan 05/13/2024

**Selected Solution:**

- Retire the Essex Switch to Newark Bay Cogen circuit (J-2210) assets
  - Remove circuit assets (i.e., cable, fluid, and station equipment)
  - Abandon pipe/conduit and manhole system

**Estimated Cost:** \$2M

**Projected In-Service:** October 2024

**Supplemental Project ID:** s3277.1

**Project Status:** Engineering and Planning

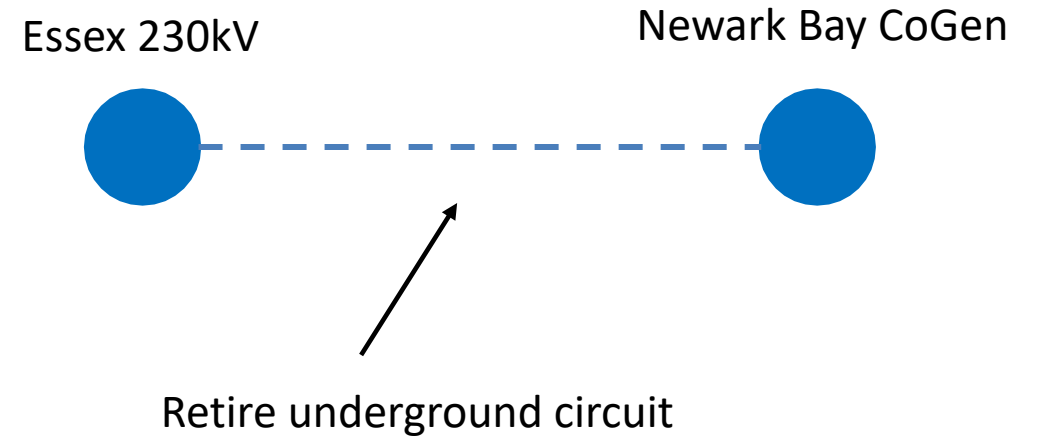



# PSE&G Transmission Zone M-3 Process Port Elizabeth Area

**Need Number:** PSEG-2024-0001

**Process Stage:** Submission of Supplemental Project for inclusion in the Local Plan 6/21/2024

**Previously Presented:**

- Needs Meeting: 2/15/2024
- Solutions Meeting: 4/18/2024

**Supplemental Project Driver:**

- Station Condition/Likelihood of Failure
- Equipment Material Condition, Performance and Risk
- Customer Service

**Specific Assumption Reference:**

[PSE&G 2024 Annual Assumptions](#)

[August 2017 26kV to 69kV PSE&G Presentation](#)

- Equipment Reliability and Condition Assessment
- Asset Risk Model
- Localized Load Growth & Contingency Overloads

**Problem Statement:**

- First Street substation is a station in the Port Elizabeth Area with equipment and building condition issues.
  - Station equipment at First Street is in poor condition and needs to be addressed.
  - The First Street Substation building is over 90 years old, is in poor condition, and is not in compliance with today's NJ UCC requirements.
  - First Street serves roughly 6,600 customers and 18.5 MVA of load.
- PSE&G has received 9 service requests with a projected load of 8.0MW for the Port of Newark/Elizabeth area. Additional capacity is needed. Existing substations in the area cannot meet current and anticipated demand.

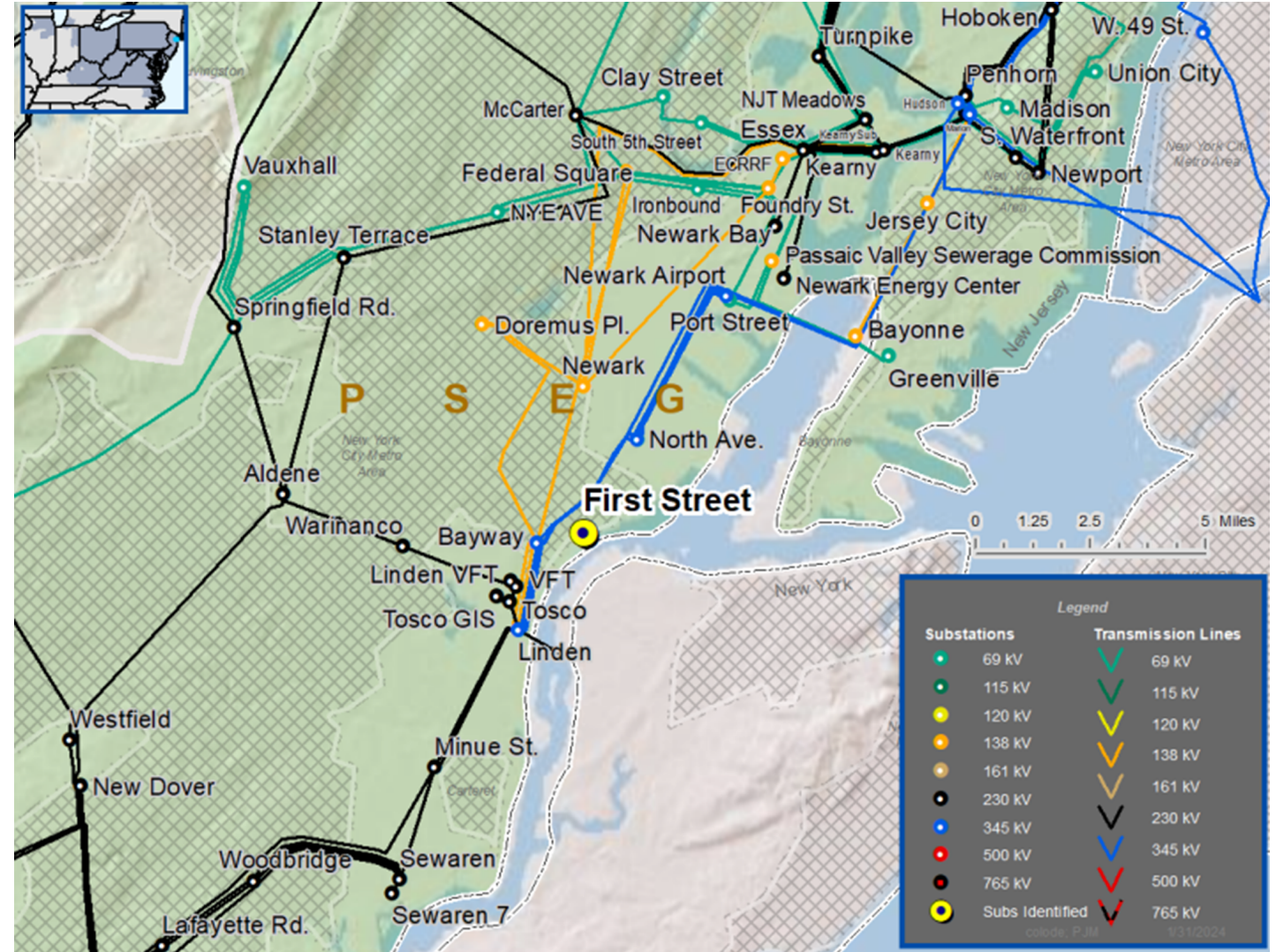



# PSE&G Transmission Zone M-3 Process Port Elizabeth Area

**Need Number:** PSEG-2024-0001

**Process Stage:** Submission of Supplemental Project for inclusion in the Local Plan 6/21/2024

**Proposed Solution:**

- Construct new 69-13kV substation at PSEG owned property in Elizabeth NJ.
  - Install two (2) 69/13kV transformers.
  - Cut and loop Roselle – Elizabeth 69kV line into the new 69kV bus.
  - Build new 69kV circuit to Port Street.

**Estimated Cost:** \$222.7M

**Projected In-Service:** 06/2029

**Supplemental Project ID:** s3310

**Project Status:** Engineering and Planning

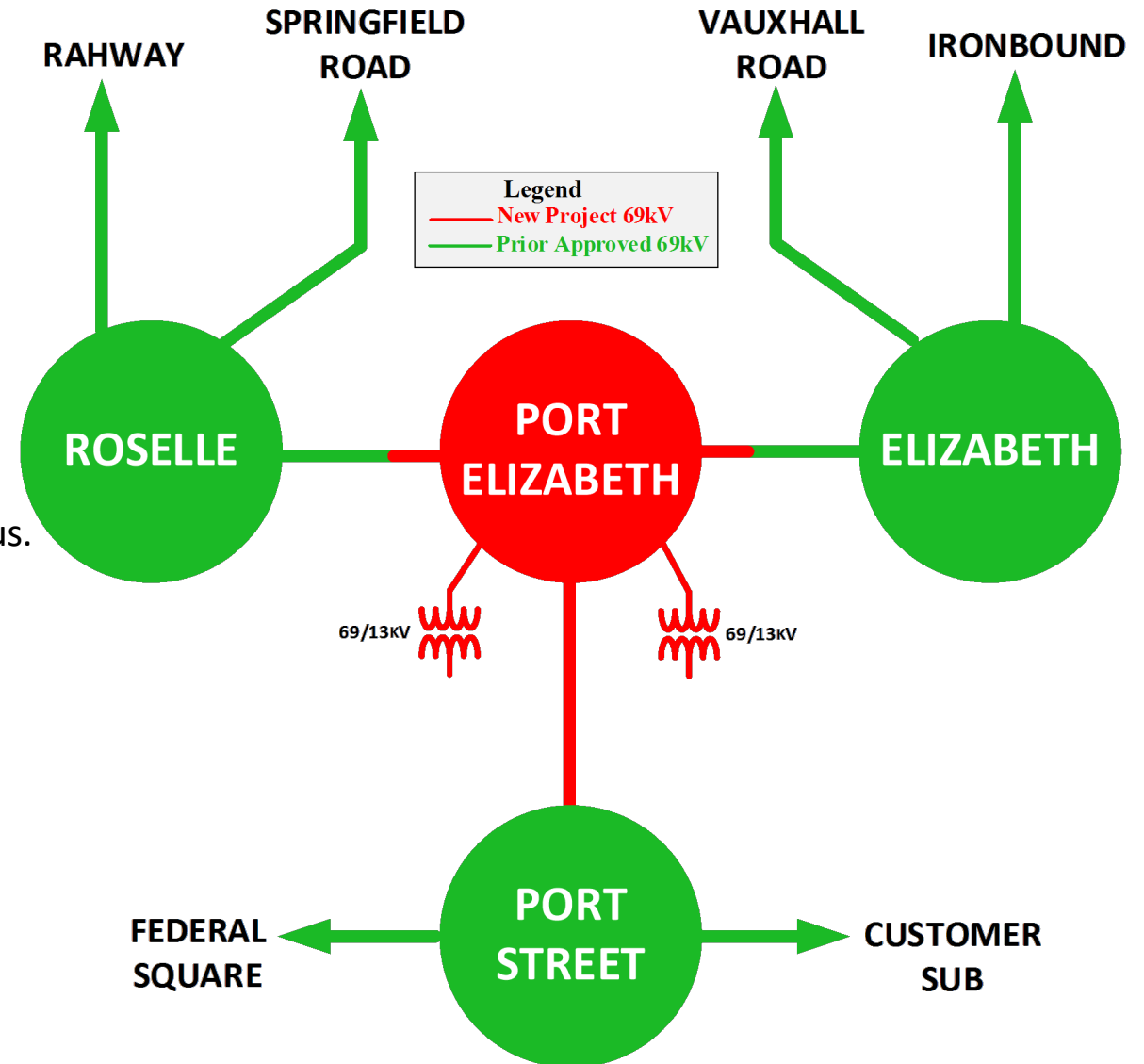



# Revision History

2/7/2024 – V1 – s3007, s3008, s3009, s3010

2/26/2024 – V2 – s3090

3/15/2024 – V3 – s3184.1

5/13/2024 – V4 – s3276.1, s3277.1

6/24/2024 – V5 – s3310