

# Subregional RTEP Committee – Western FirstEnergy Supplemental Projects



# Submission of Supplemental Projects for Inclusion in the Local Plan

**Need Number:** AEP-2019-OH034  
**Process Stage:** Submission of Supplemental Project for Inclusion in the Local -1/4/2024  
**Previously Presented:** Need Meeting 6/17/2019  
 Solutions Meeting 3/18/2022

**Supplemental Project Driver:** Operational Flexibility, and Customer Service

**Specific Assumption Reference:**

AEP Guidelines for Transmission Owner Identified Needs (AEP Assumptions slide 8)

**Problem Statement:**

South Greenwich-Willard (vintage 1964)

- Length: 15.22 Miles
- Original Construction Type: Wood
- Original Conductor Type: 4/0 ACSR 6/1 (Penguin)
- Momentary/Permanent Outages: 13 in the past 5 years
- Number of open conditions: 77

Open conditions include: Damaged Insulator, Structure, Guy Wire, Ground

- Lead Wire, & Shield Wire

Radial service severely restricts the ability to perform routine maintenance and restoration activities. The maintenance of radial transmission lines often requires costly temporary facilities or other labor-intensive measures involving energized work because a maintenance outage to such radial loads is generally not feasible.

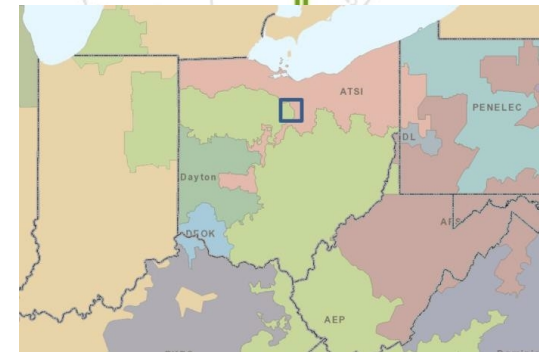
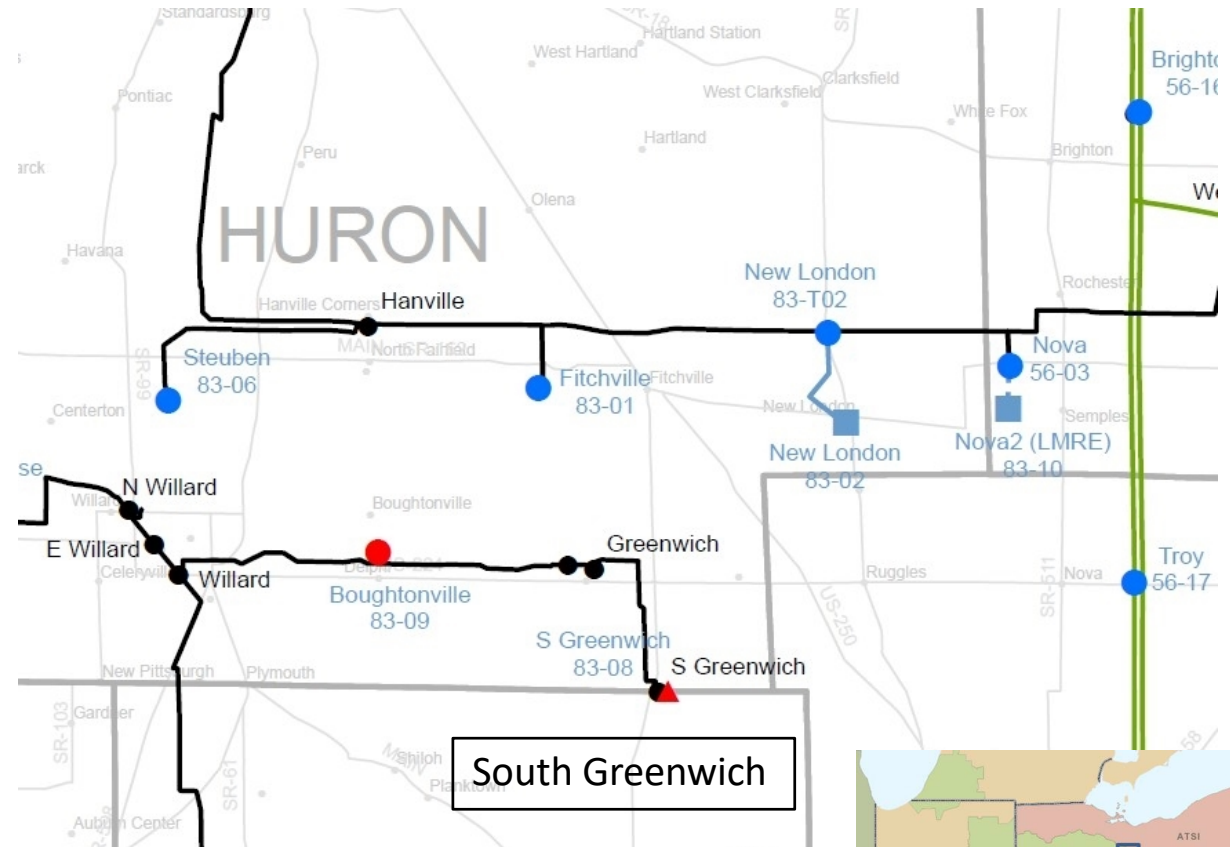



# ATSI Transmission Zone M-3 Process New New London 69 kV Project

**Need Number:** AEP-2019-OH034  
**Process Stage:** Submission of Supplemental Project for Inclusion in the Local - 1/4/2024

## Solution:

### ATSI Scope:

- Build a new four breaker 69 kV ring bus substation adjacent to the Fireland's New London distribution substation
- Acquire the Fireland 69 kV tap (~2 miles) and rebuild as a double circuit into the new ring bus and loop in/out the Hanville-Wellington 69 kV line.
- Serve the Firelands New London distribution substation from the new ring bus substation.
- Transfer the existing Firelands New London revenue metering from the existing location (line) into the Firelands New London distribution substation at the transformer high side within the zone of protection.
- Install new 69 kV tie line revenue metering equipment at the new ring bus substation exit to South Greenwich (AEP)
- Upgrade/adjust relaying at Hanville and Wellington
- Upgrade terminal equipment at Wellington

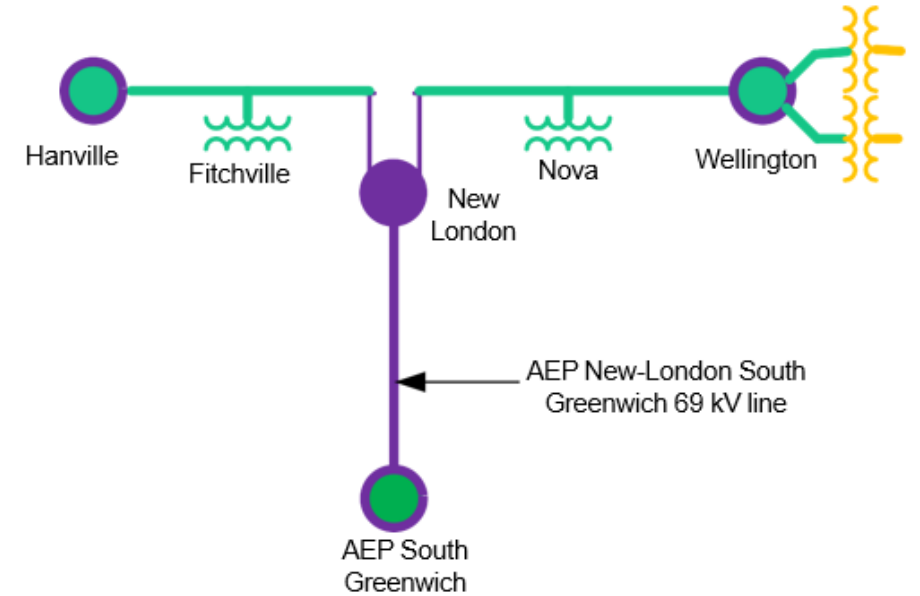

Legend	
500 kV	Red line
345 kV	Blue line
138 kV	Yellow line
69 kV	Green line
34.5 kV	Red line
23 kV	Yellow line
New	Purple line

Continued on next slide...



# ATSI Transmission Zone M-3 Process New New London 69 kV Project

**Need Number:** AEP-2019-OH034  
**Process Stage:** Submission of Supplemental Project for Inclusion in the Local -1/4/2024

**Transmission Line Ratings:**

- Hanville-New London 69 kV Line
  - Before Proposed Solution: N/A
  - After Proposed Solution: 100 MVA SN / 121 MVA SE
- New London-Wellington 69 kV Line
  - Before Proposed Solution: N/A
  - After Proposed Solution: 100 MVA SN / 121 MVA SE
- New London-South Greenwich (AEP) 69 kV line
  - Before Proposed Solution: N/A
  - After Proposed Solution: (AEP) 102 MVA SN / (AEP) 142 MVA SE

**Estimated ATSI Project Cost:** \$10.0M  
**Projected In-Service:** 9/3/2025  
**Supplemental Project ID:** s2748.8

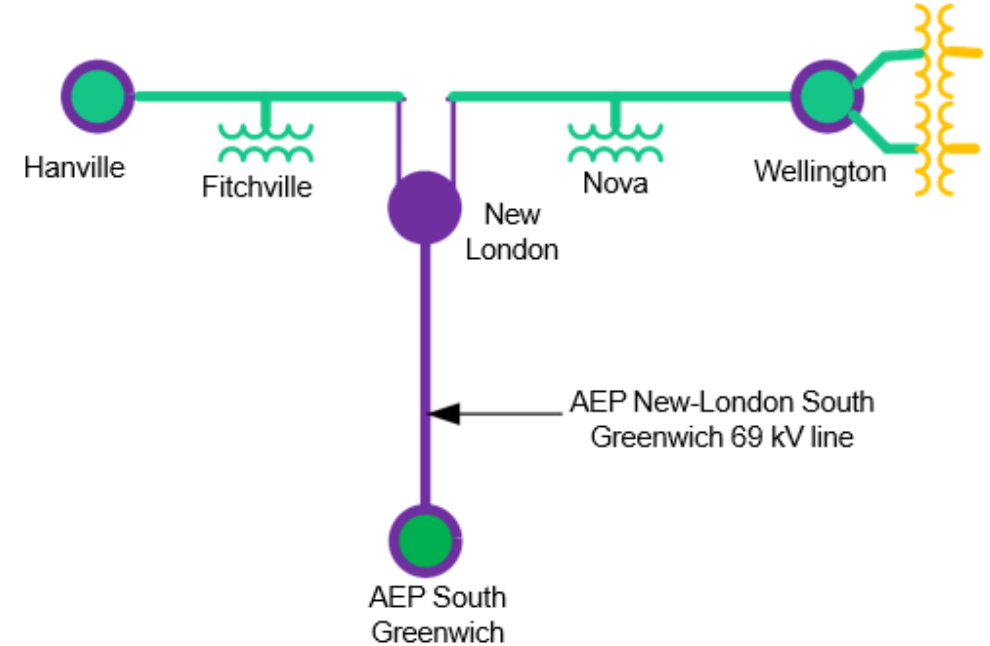

Legend	
500 kV	
345 kV	
138 kV	
69 kV	
34.5 kV	
23 kV	
New	

**Need Number:** ATSI-2023-005  
**Process Stage:** Submission of Supplemental Projects for Inclusion in the Local Plan – 4/26/2024  
**Previously Presented:** Need Meeting – 5/19/2023  
 Solution Meeting – 7/21/2023

**Project Driver(s):**  
 Customer Service

**Specific Assumption Reference(s)**

Customer connection request will be evaluated per FirstEnergy’s “Requirements for Transmission Connected Facilities” document and “Transmission Planning Criteria” document.

**Problem Statement**

Customer Connection – Customer is requesting to reconnect service at an existing 69 kV delivery point on the Carlisle – Woodford 69 kV Line. The anticipated load of the new customer connection is 6 MVA.

Requested in-service date is 11/17/2023

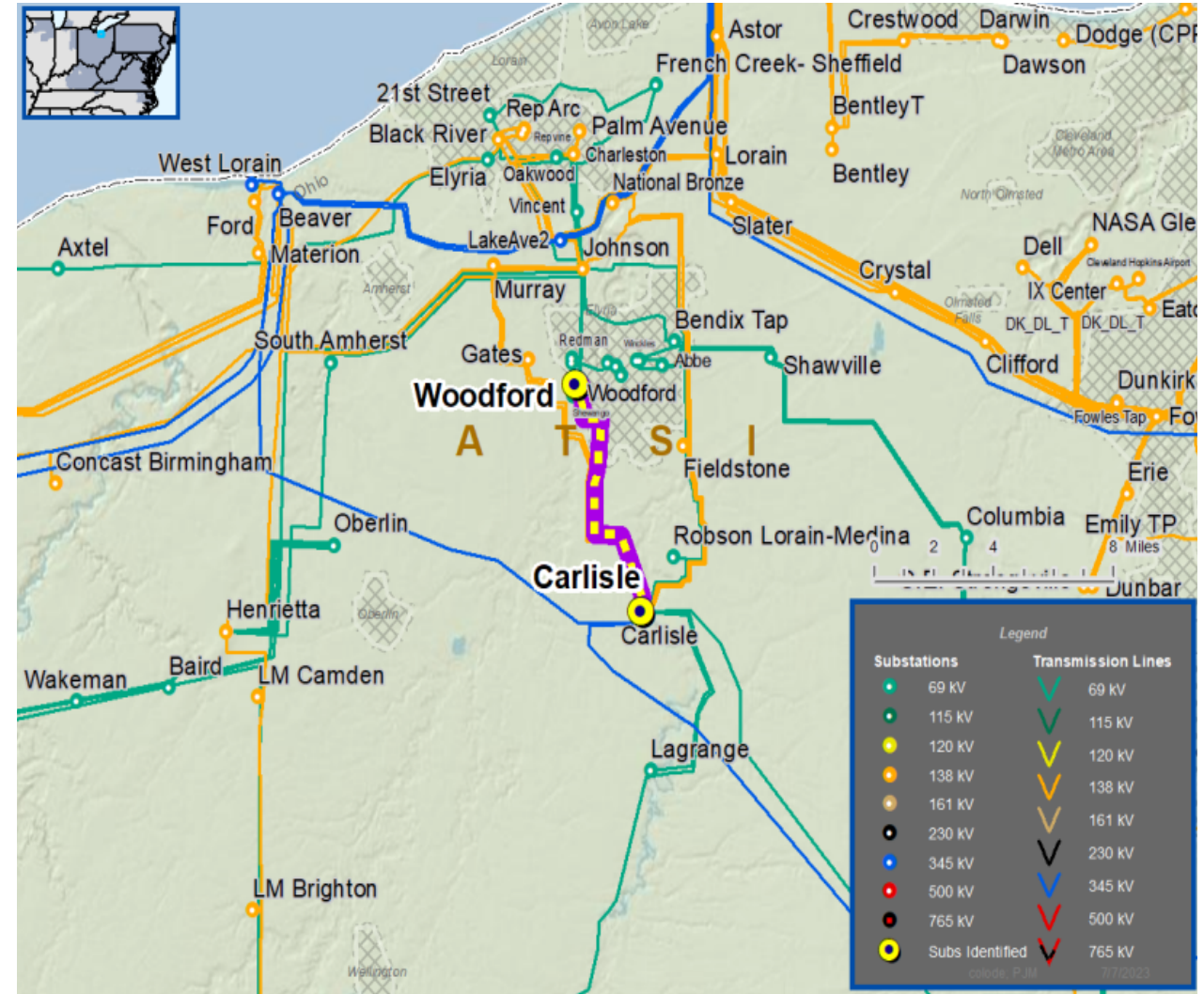



# ATSI Transmission Zone M-3 Process Carlisle - Woodford 69 kV Line Customer Connection

**Need Number:** ATSI-2023-005  
**Process Stage:** Submission of Supplemental Projects for Inclusion in the Local Plan – 4/26/2024

**Selected Solution:**

**69 kV Transmission Line Tap Reconnection**

- Install two main-line SCADA controlled switch
- Install one tap-line SCADA controlled switch

**Estimated Project Cost:** \$1.3M  
**Projected In-Service:** 11/17/2023  
**Supplemental Project ID:** s3129.1

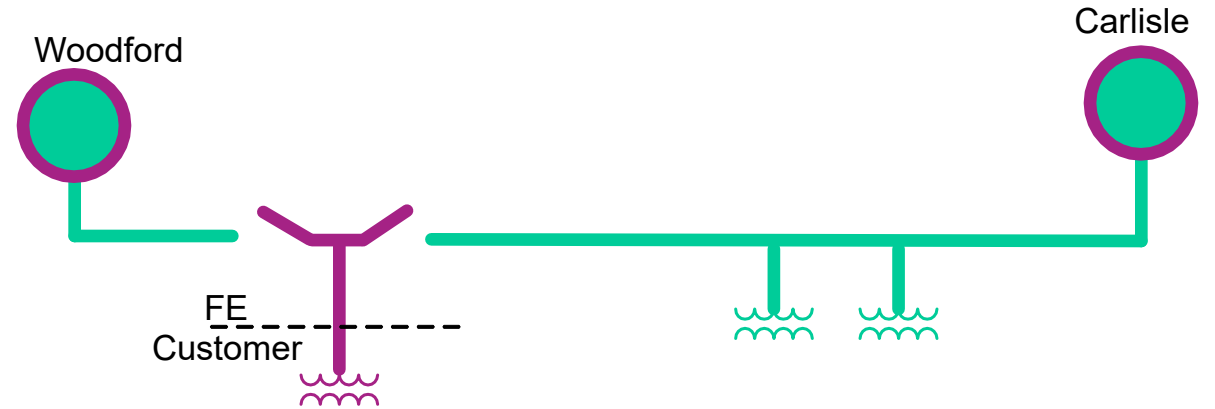

Legend	
500 kV	
345 kV	
138 kV	
69 kV	
34.5 kV	
23 kV	
New	

**Need Number:** ATSI-2023-006  
**Process Stage:** Submission of Supplemental Projects for Inclusion in the Local Plan – 4/26/2024  
**Previously Presented:** Need Meeting – 05/19/2023  
 Solution Meeting – 7/21/2023

**Supplemental Project Driver(s):**  
*Customer Service*

**Specific Assumption Reference(s):**  
 New customer connection request will be evaluated per FirstEnergy’s “Requirements for Transmission Connected Facilities” document and “Transmission Planning Criteria” document.

**Problem Statement**  
 New Customer Connection – Customer requested 69 kV transmission service for approximately 9.6 MVA of total load near the Campbellsport – Ravenna No 1 69 kV Line.

**Requested In-Service Date:**  
 April 28, 2024

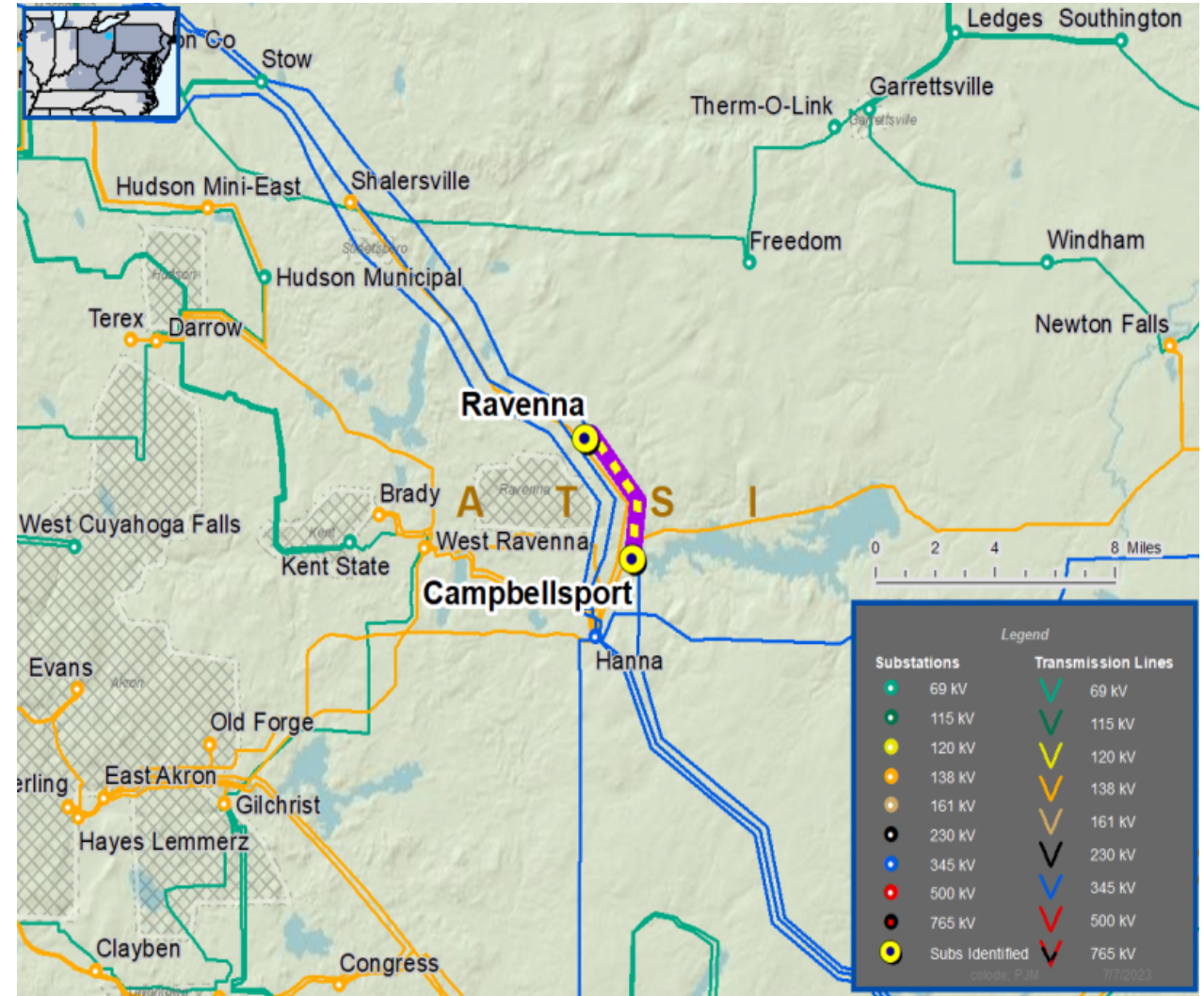



# ATSI Transmission Zone M-3 Process Campbellsport – Ravenna No 1 69 kV Line New Customer

**Need Number:** ATSI-2023-006  
**Process Stage:** Submission of Supplemental Projects for Inclusion in the Local Plan – 4/26/2024

**Selected Solution:**

**69 kV Transmission Line Tap**

- Install three SCADA controlled load-break switches
- Construct approximately 0.4 miles of transmission line using 477 kcmil ACSR 26/7 conductor from tap point to Customer substation
- Relay settings revised at Ravenna and Campbellsport

**Estimated Project Cost:** \$0.8M  
**Projected In-Service:** 04/08/2024  
**Supplemental Project ID:** s3130.1

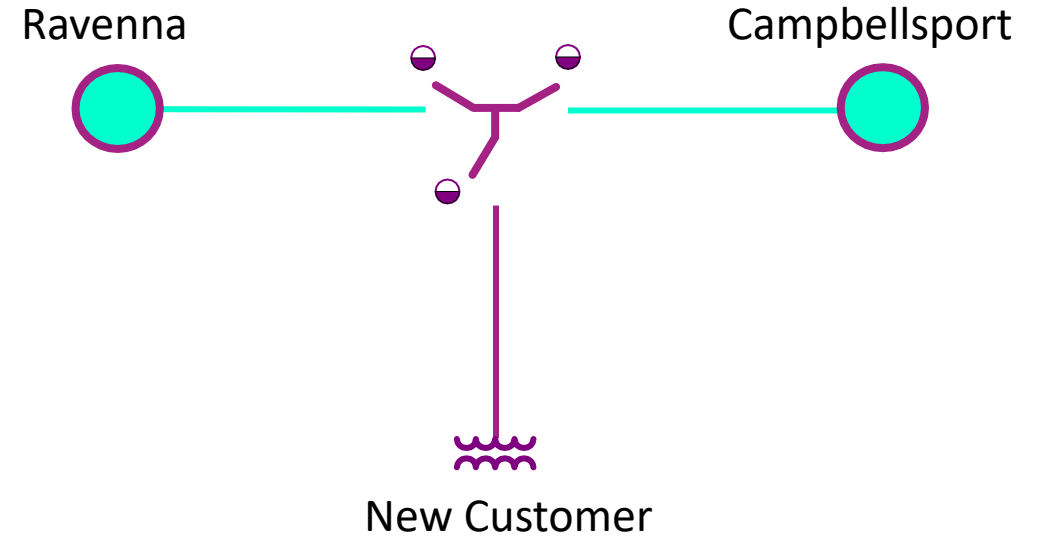

Legend	
500 kV	
345 kV	
138 kV	
69 kV	
34.5 kV	
23 kV	
New	

# ATSI Transmission Zone M-3 Process Napoleon – Campbell Soup 69 kV Line Customer Connection

**Need Number:** ATSI-2023-007  
**Process Stage:** Submission of Supplemental Projects for Inclusion in the Local Plan – 4/26/2024  
**Previously Presented:** Need Meeting – 06/16/2023  
 Solution Meeting – 8/18/2023

**Supplemental Project Driver(s):**

*Customer Service*

**Specific Assumption Reference(s):**

New customer connection request will be evaluated per FirstEnergy’s “Requirements for Transmission Connected Facilities” document and “Transmission Planning Criteria” document.

**Problem Statement**

Customer Connection – Customer is requesting to retire an existing 69 kV delivery point on the Napoleon – Campbell Soup 69 kV Line. In addition, the customer is requesting a new 69 kV delivery point along the same transmission line to replace the retired delivery point which will have an anticipated load of 25 MVA.

**Requested In-Service Date:**

03/31/2024

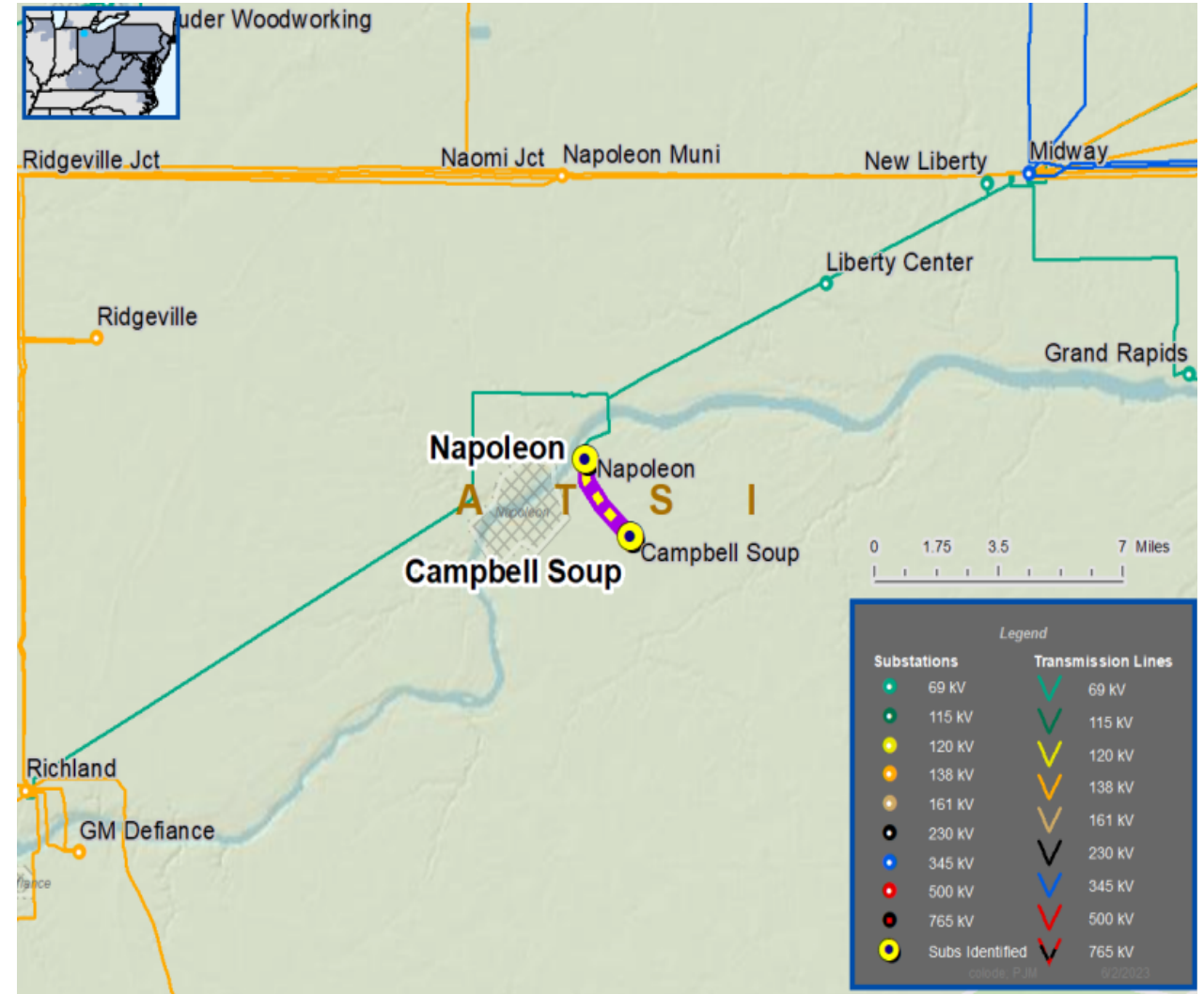



# ATSI Transmission Zone M-3 Process Napoleon – Campbell Soup 69 kV Line Customer Connection

**Need Number:** ATSI-2023-007  
**Process Stage:** Submission of Supplemental Projects for Inclusion in the Local Plan – 4/26/2024

**Selected Solution:**

**69 kV Transmission Line Tap**

- Install one SCADA controlled transmission line switch
- Construct approximately 1-2 spans of transmission line using 336.4 26/7 ACSR from tap point to the customer substation
- Retire and remove all distribution owned assets from Campbell Soup #1 substation along with transmission line portion from new interconnection to existing substation.

**Estimated Project Cost:** \$0.0M  
**Projected In-Service:** 3/31/2024  
**Supplemental Project ID:** s3132.1

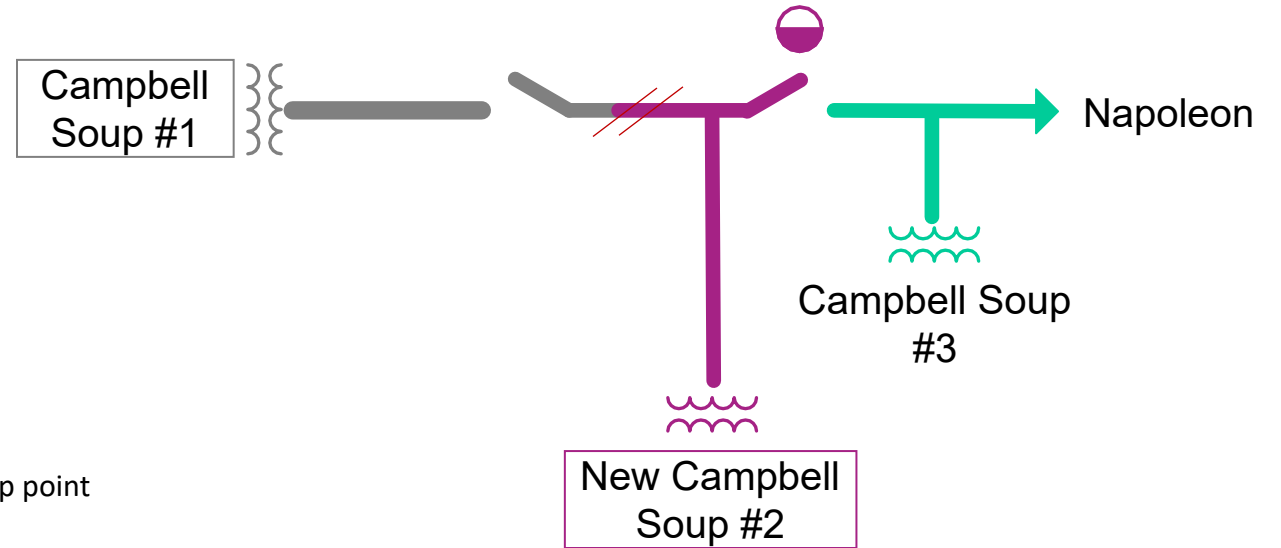

Legend	
500 kV	
345 kV	
138 kV	
69 kV	
34.5 kV	
23 kV	
New	

**Need Number:** ATSI-2023-022  
**Process Stage:** Submission of Supplemental Projects for Inclusion in the Local Plan – 4/26/2024  
**Previously Presented:** Need Meeting – 8/18/2023  
 Solution Meeting – 10/20/2023

**Supplemental Project Driver(s):**  
 Customer Service

**Specific Assumption Reference(s):**

New customer connection request will be evaluated per FirstEnergy’s “Requirements for Transmission Connected Facilities” document and “Transmission Planning Criteria” document.

**Problem Statement**

New Customer Connection – has requested a new 138 kV delivery point from the Cloverdale 138 kV Substation. The anticipated load of the new customer connection is 200 MVA.

**Requested In-Service Date:**

October 1, 2022

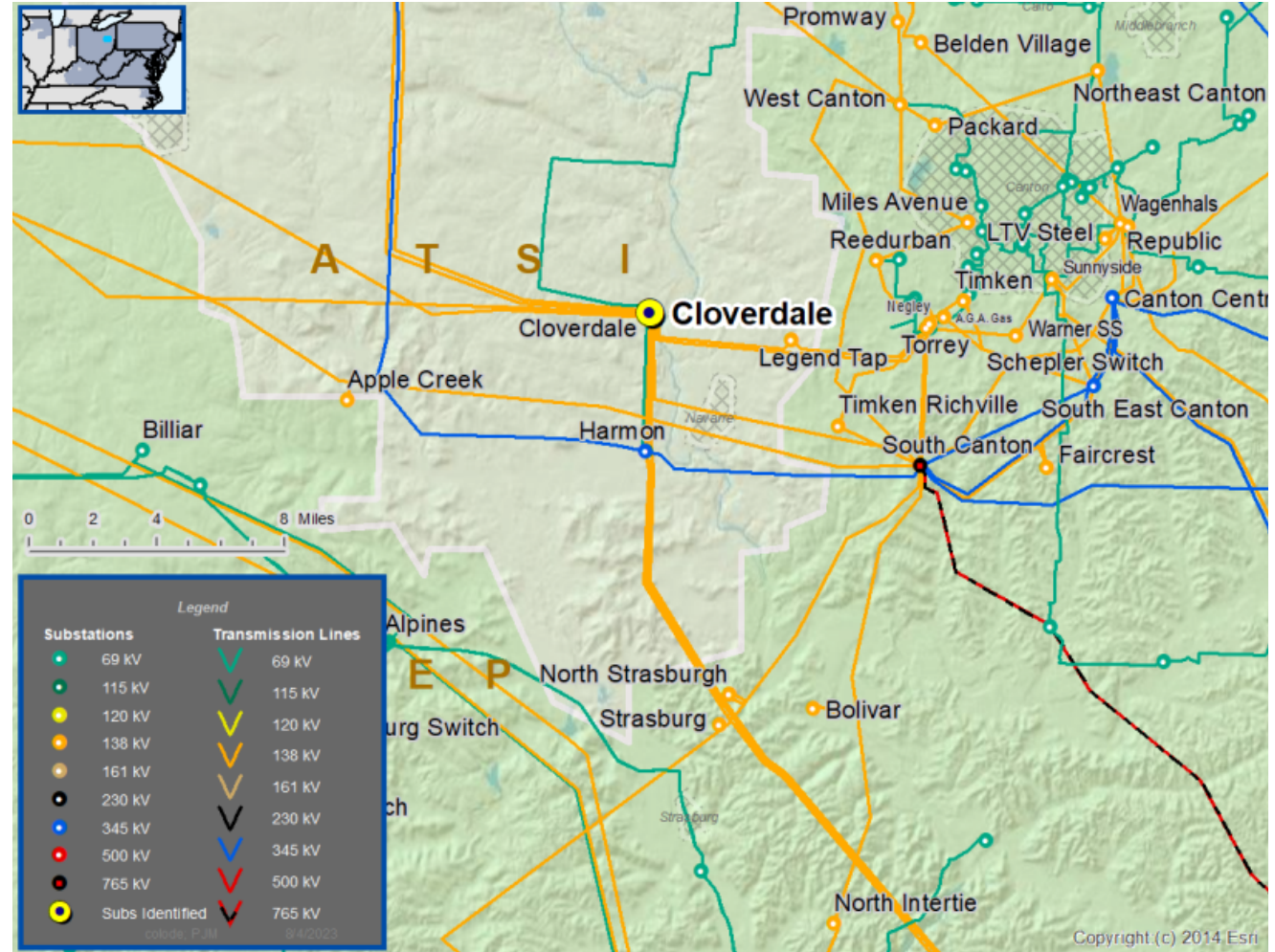

**Need Number:** ATSI-2023-022  
**Process Stage:** Submission of Supplemental Projects for Inclusion in the Local Plan – 4/26/2024

**Selected Solution:**

**138 kV Direct Substation Delivery Point**

- Install a 138 kV circuit breaker at the Cloverdale 138 kV North bus.
- Construct approximately 0.1 miles of transmission line from the Cloverdale Substation to the customer substation.
- Install one SCADA controlled transmission line switch.

**Estimated Project Cost:** \$0.0  
**Projected In-Service:** 12/1/2025  
**Supplemental Project ID:** s3106.1

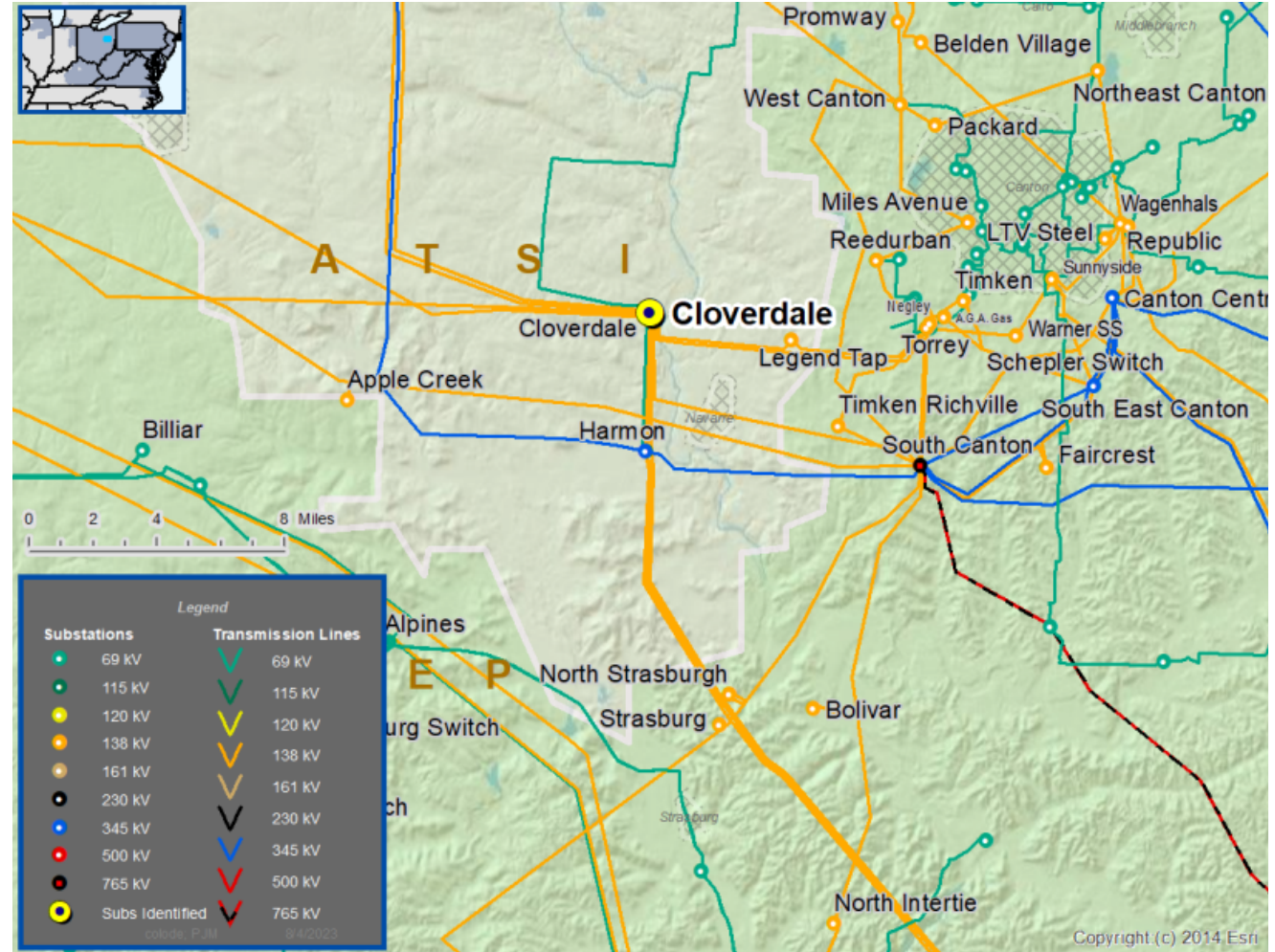

**Need Numbers:** ATSI-2023-019  
**Process Stage:** Submission of Supplemental Projects for Inclusion in the Local Plan – 4/26/2024  
**Previously Presented:** Need Meeting – 09/15/2023  
 Solution Meeting – 11/17/2023

**Project Driver:**  
*Equipment Material Condition, Performance and Risk*

**Specific Assumption Reference:**

System Performance Projects Global Factors

- System reliability and performance
- Substation/line equipment limits
- Upgrade Relay Schemes
- Obsolete and difficult to repair communication equipment (DTT, Blocking, etc.)
- Communication technology upgrades

**Problem Statement:**

- FirstEnergy has identified protection schemes using a certain vintage of relays and communication equipment that have a history of misoperation.
- Proper operation of the protection scheme requires all the separate components perform adequately during a fault.
- In many cases the protection equipment cannot be repaired due to a lack of replacement parts and available expertise in the outdated technology.
- Transmission line ratings are limited by terminal equipment.

**Continued on next slide...**

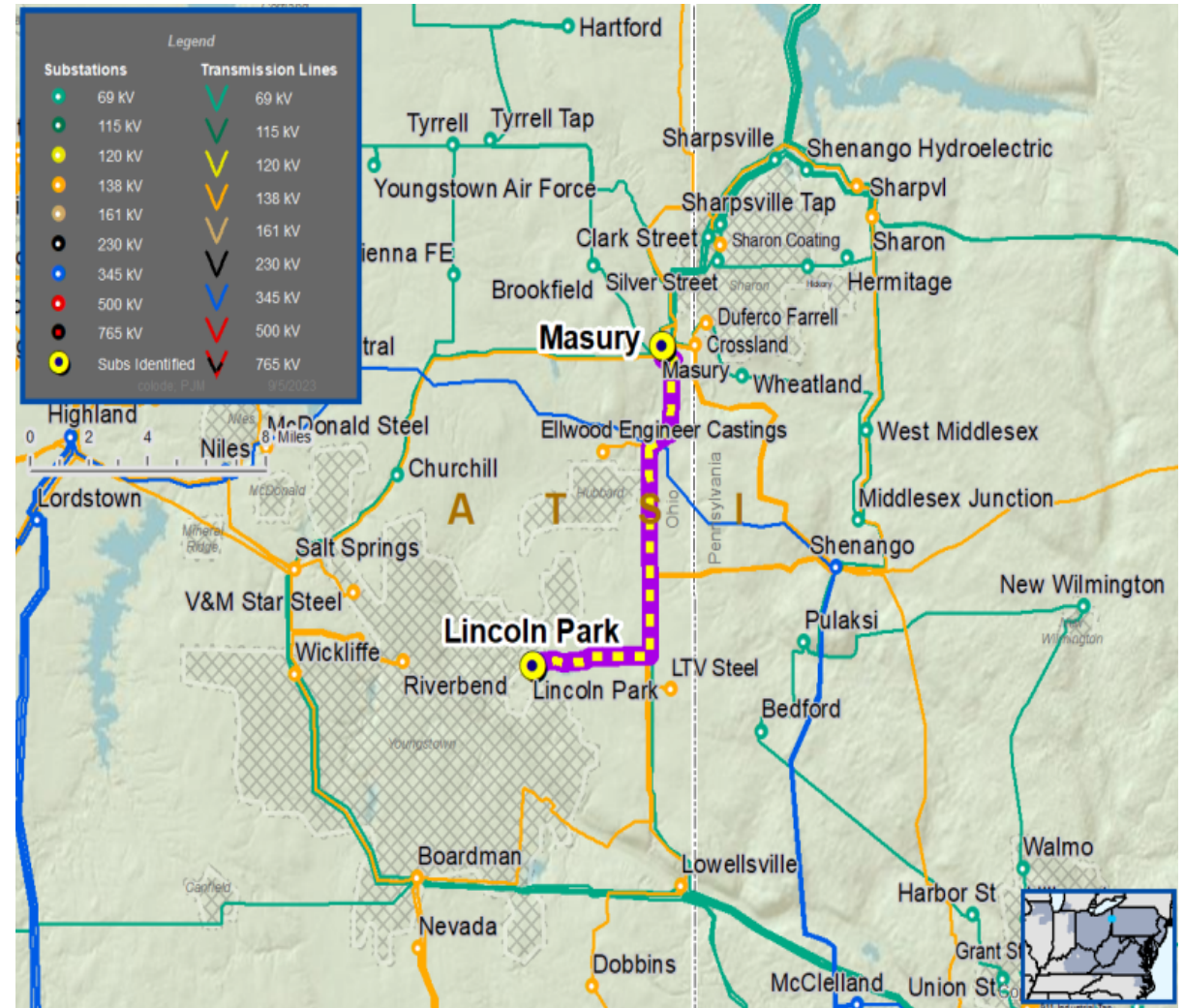



# ATSI Transmission Zone M-3 Process Masury 138 kV Misoperation Relays

Need #	Transmission Line / Substation Locations	Existing Line Rating (SN / SE)	Existing Conductor Rating (SN / SE)
ATSI-2023-019	Masury – Elwood Tap 138 kV Line	164 / 191	187 / 191
	Lincoln Park – Elwood Tap 138 kV Line	155 / 155	187 / 191



# ATSI Transmission Zone M-3 Process Masury 138 kV Misoperation Relays

**Need Number:** ATSI-2023-019  
**Process Stage:** Submission of Supplemental Projects for Inclusion in the Local Plan – 4/26/2024

**Selected Solution:**

**Masury Substation**

- Replace relaying on Lincoln Park line terminal with microprocessor relays.
- Replace (2) 138 kV breakers for Lincoln Park and Shenango lines.
- Replace (2) associated disconnect switches.

**Lincoln Park Substation**

- Replace relaying on Masury line terminal with microprocessor relays.
- Replace (2) 138 kV breakers for Masury Line.
- Replace (4) associated disconnect switches.

Continued on next slide...



Legend	
500 kV	
345 kV	
138 kV	
69 kV	
34.5 kV	
23 kV	
New	





# ATSI Transmission Zone M-3 Process Masury 138 kV Misoperation Relays

**Need Number:** ATSI-2023-019  
**Process Stage:** Submission of Supplemental Projects for  
Inclusion in the Local Plan – 4/26/2024

## Transmission Line Ratings:

Need #	Transmission Line / Substation Locations	Existing Line Ratings (SN / SE / WN / WE)	New Line Ratings (SN / SE / WN / WE)
ATSI-2023-019	Masury – Elwood Tap 138 kV Line Section	164 / 191 / 211 / 211	187 / 191 / 211 / 211
	Lincoln Park – Elwood Tap 138 kV Line Section	155 / 155 / 155 / 155	187 / 191 / 211 / 211

**Estimated Project Cost:** \$3.4M  
**Projected In-Service:** 12/31/2025  
**Supplemental Project ID:** s3118.1

**Need Number:** ATSI-2023-020  
**Process Stage:** Submission of Supplemental Projects for Inclusion in the Local Plan – 4/26/2024  
**Previously Presented:** Need Meeting – 10/20/2023  
 Solution Meeting – 11/17/2023

**Project Driver:**

*Equipment Material Condition, Performance and Risk*

**Specific Assumption Reference:**

System Performance Projects Global Factors

- System reliability and performance
- Substation/line equipment limits
- Upgrade Relay Schemes
- Obsolete and difficult to repair communication equipment (DTT, Blocking, etc.)
- Communication technology upgrades

**Problem Statement:**

- FirstEnergy has identified protection schemes using a certain vintage of relays and communication equipment that have a history of misoperation.
- Proper operation of the protection scheme requires all the separate components perform adequately during a fault.
- In many cases the protection equipment cannot be repaired due to a lack of replacement parts and available expertise in the outdated technology.
- Transmission line ratings are limited by terminal equipment.

**Continued on next slide...**

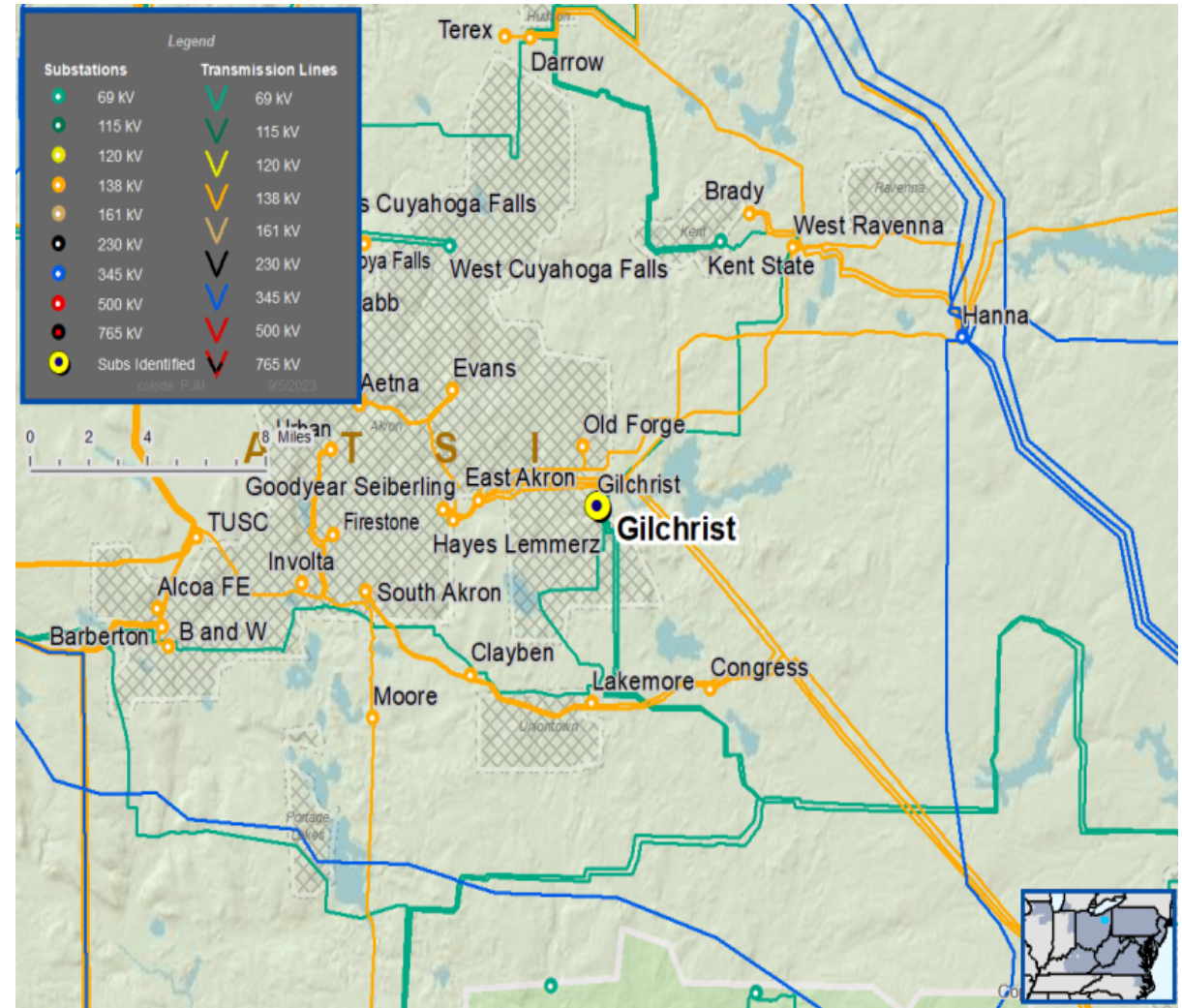



## ATSI Transmission Zone M-3 Process Gilchrist - Hartville 69 kV Misoperation Relays

Need #	Transmission Line / Substation Locations	Existing Line Rating (SN / SE)	Existing Conductor Rating (SN / SE)
ATSI-2023-020	Hartville – Trelleborg Tap 69 kV Line	76 / 76	76 / 92
ATSI-2023-020	Gilchrist - Burger-Rubbermaid Tap 69 kV Line	76 / 92	76 / 92



# ATSI Transmission Zone M-3 Process Gilchrist - Hartville 69 kV Misoperation Relays

**Need Number:** ATSI-2023-020  
**Process Stage:** Submission of Supplemental Projects for  
Inclusion in the Local Plan – 4/26/2024

**Selected Solution:**

***Gilchrist Substation***

- Replace one circuit breaker, associated disconnect switches and relaying for Hartville line terminal.

***Hartville Substation***

- Replace one circuit breaker, associated disconnect switches and relaying for Gilchrist line terminal.

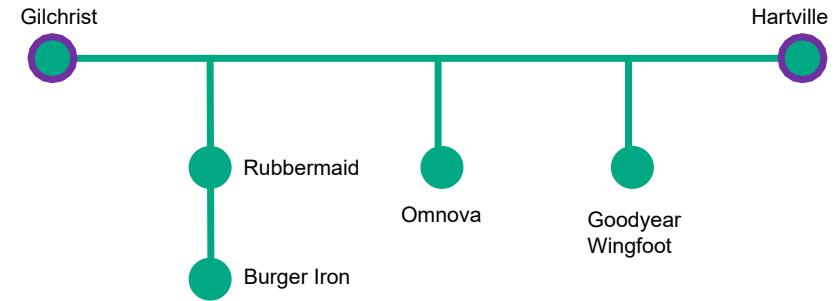

Legend	
500 kV	
345 kV	
138 kV	
69 kV	
34.5 kV	
23 kV	
New	

Continued on next slide...



# ATSI Transmission Zone M-3 Process Gilchrist - Hartville 69 kV Misoperation Relays

**Need Number:** ATSI-2023-020  
**Process Stage:** Submission of Supplemental Projects for  
Inclusion in the Local Plan – 4/26/2024

## Transmission Line Ratings:

Need #	Transmission Line / Substation Locations	Existing Line Ratings (SN / SE / WN / WE)	New Line Rating (SN / SE / WN / WE)
ATSI-2023-020	Hartville – Trelleborg Tap 69 kV Line	76 / 76 / 76 / 76	76 / 92 / 87 / 111
	Gilchrist - Burger-Rubbermaid Tap 69 kV Line	76 / 92 / 87 / 101	76 / 92 / 87 / 111

**Estimated Project Cost:** \$1.6M  
**Projected In-Service:** 6/1/2026  
**Supplemental Project ID:** s3119.1

**Need Number:** ATSI-2023-023  
**Process Stage:** Submission of Supplemental Projects for Inclusion in the Local Plan – 4/26/2024  
**Previously Presented:** Need Meeting – 10/20/2023  
 Solution Meeting – 11/17/2023

**Supplemental Project Driver(s):**  
*Equipment Material Condition, Performance, and Risk  
 Operational Flexibility and Efficiency  
 Infrastructure Resilience*

**Specific Assumption Reference(s)**

- Substation / Line equipment limits
- System reliability and performance
- Reliability of Non-Bulk Electric System (Non-BES) Facilities

**Problem Statement**

The Vulcan 138/69 kV Transformer has been experiencing increased loading during the summer peak seasons requiring Transmission System Operators to mitigate the risk of thermal violations through operational switching.

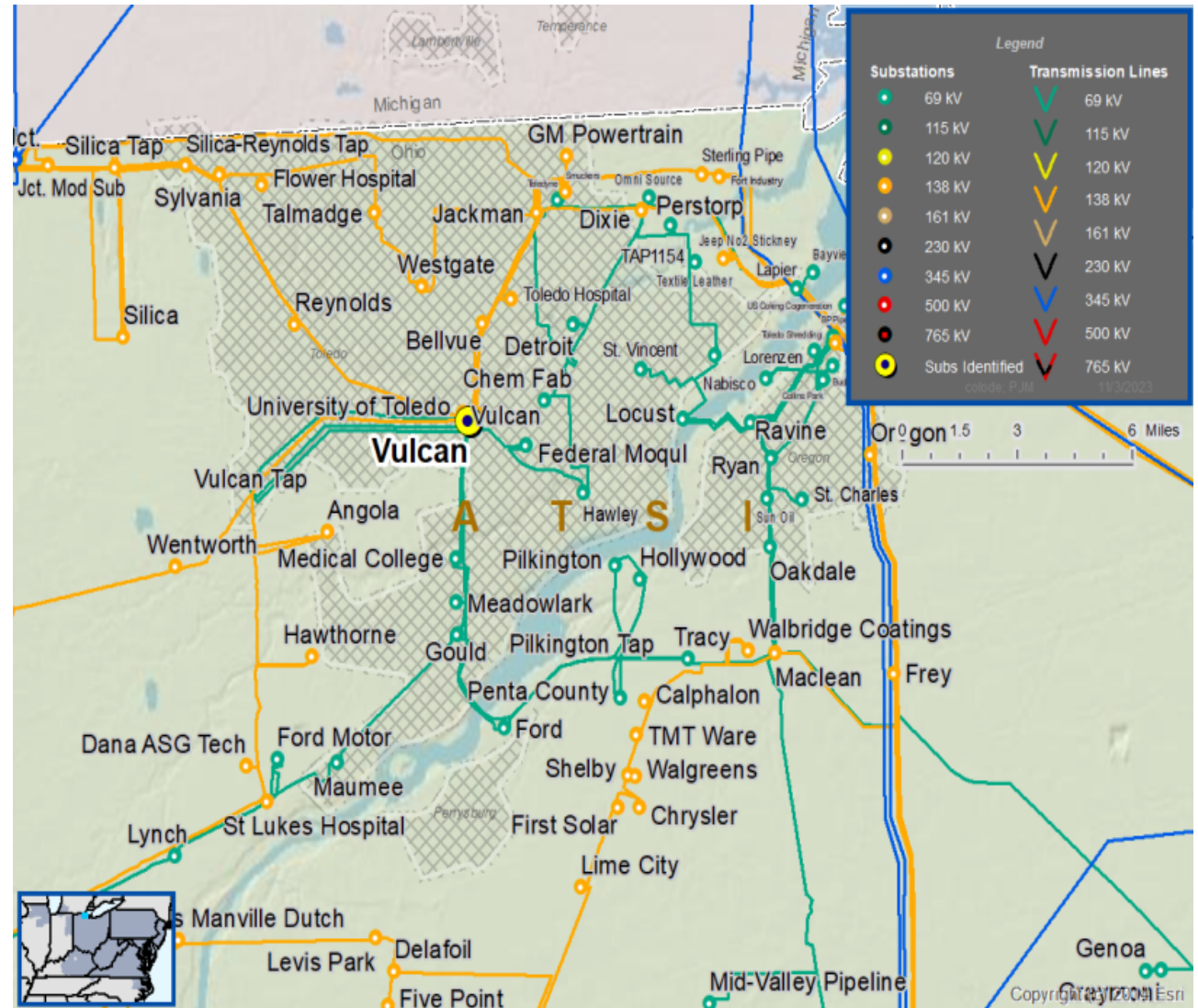

**Need Number:** ATSI-2023-023  
**Process Stage:** Submission of Supplemental Project for Inclusion in the Local Plan – 4/26/2024

**Selected Solution:**

***Vulcan 138/69 kV Transformer Terminal Upgrades***

- Replace substation conductor including the breaker leads and transformer leads

**Estimated Project Cost:** \$1.0M  
**Projected In-Service:** 3/28/2024  
**Supplemental Project ID:** s3120.1

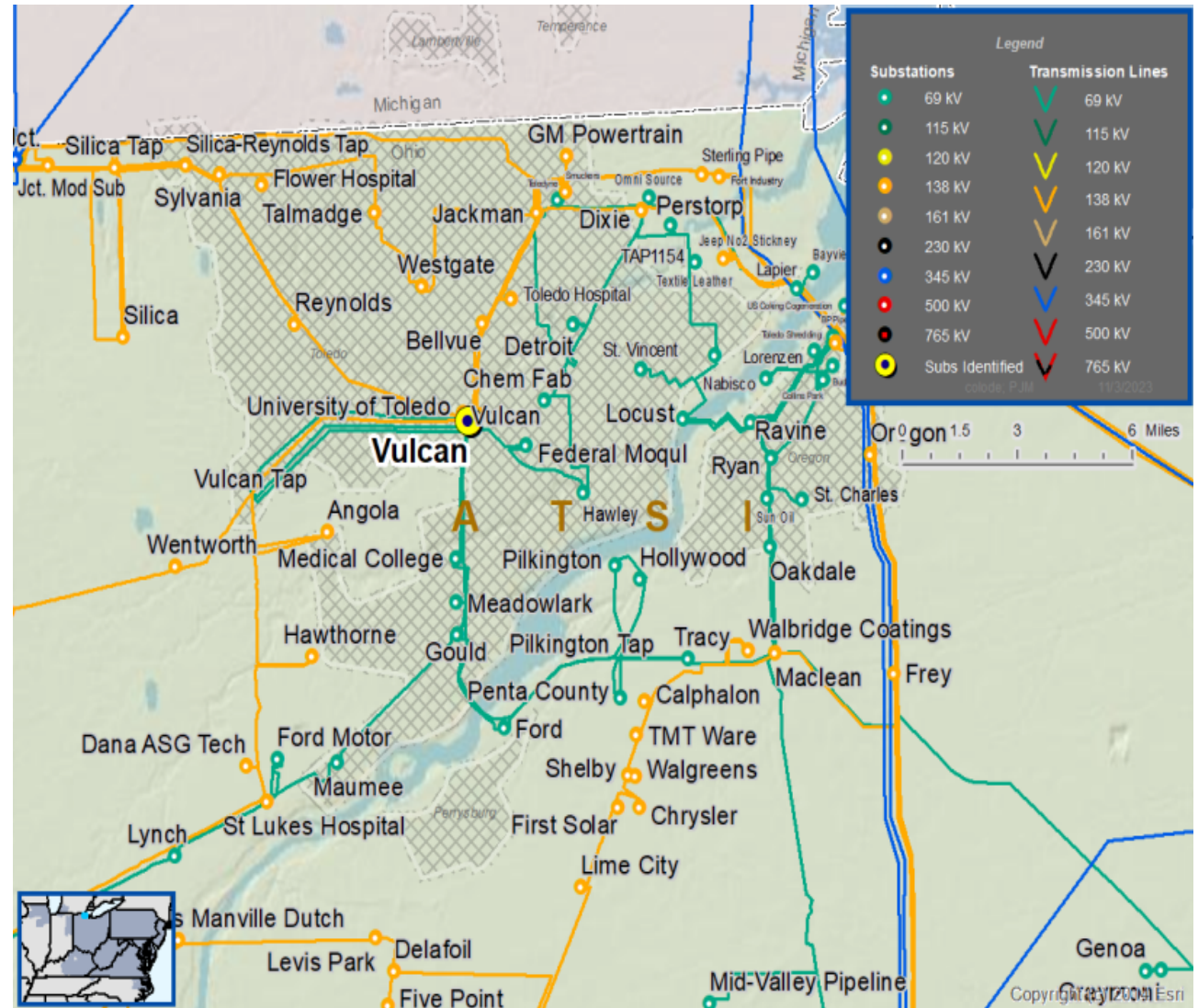

**Need Numbers:** ATSI-2023-029  
**Process Stage:** Submission of Supplemental Projects for Inclusion in the Local Plan – 4/26/2024  
**Previously Presented:** Need Meeting – 10/20/2023  
 Solution Meeting – 11/17/2023

**Project Driver:**

*Equipment Material Condition, Performance and Risk*

**Specific Assumption Reference:**

System Performance Projects Global Factors

- System reliability and performance
- Substation/line equipment limits
- Upgrade Relay Schemes
- Obsolete and difficult to repair communication equipment (DTT, Blocking, etc.)
- Communication technology upgrades

**Problem Statement:**

- FirstEnergy has identified protection schemes using a certain vintage of relays and communication equipment that have a history of misoperation.
- Proper operation of the protection scheme requires all the separate components perform adequately during a fault.
- In many cases the protection equipment cannot be repaired due to a lack of replacement parts and available expertise in the outdated technology.
- Transmission line ratings are limited by terminal equipment.

Continued on next slide...

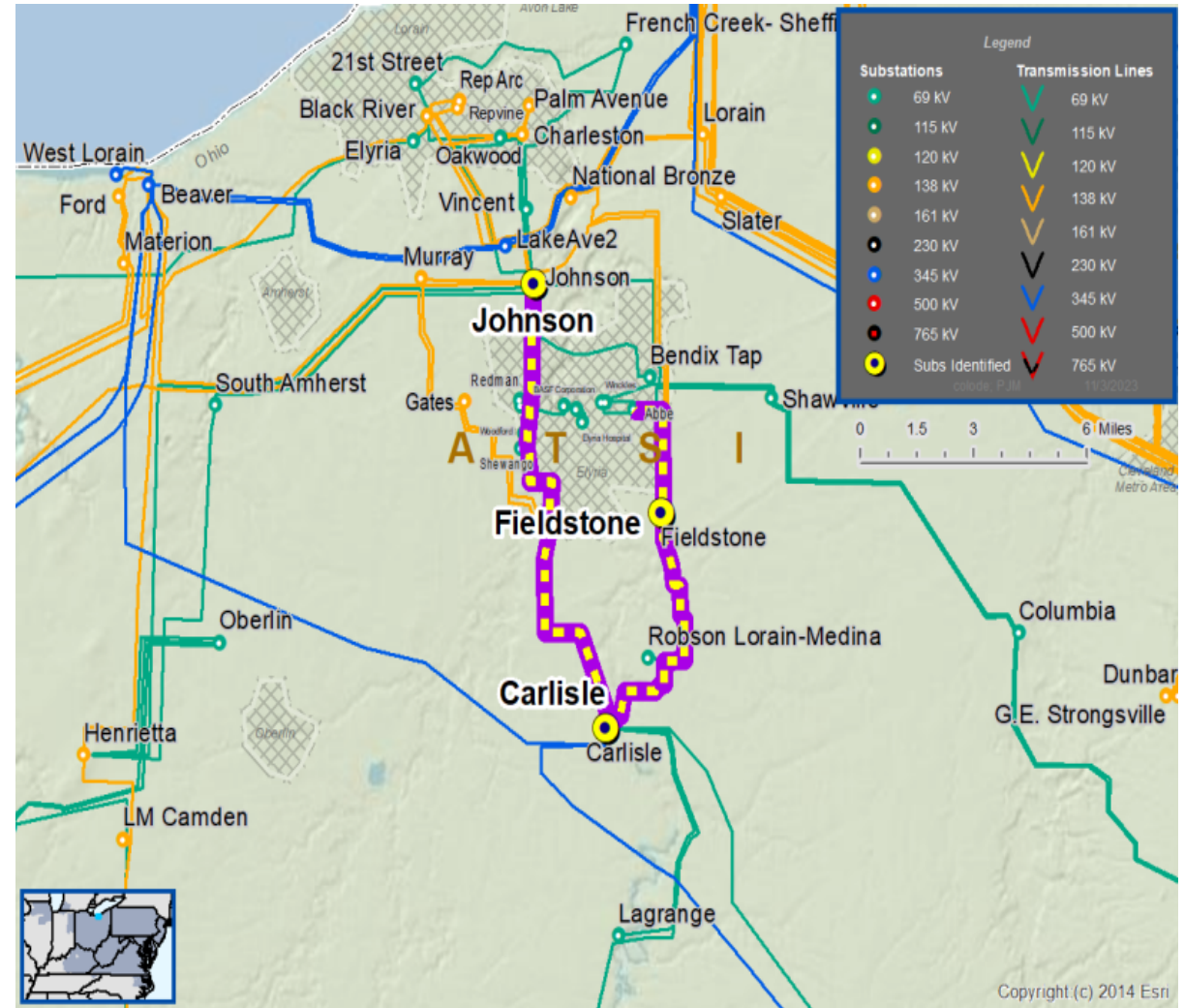





## ATSI Transmission Zone M-3 Process Carlisle – Johnson 138 kV Misoperation Relays

Need #	Transmission Line / Substation Locations	Existing Circuit Ratings (SN / SE / WN / WE)	Existing Conductor Ratings (SN / SE / WN / WE)
ATSI-2023-029	Carlisle – Fieldstone Tap 138 kV Line Section	233 / 282 / 263 / 333	233 / 282 / 263 / 333
	Fieldstone Tap – Johnson 138 kV Line Section	225 / 282 / 263 / 333	233 / 282 / 263 / 333

**Need Numbers:** ATSI-2023-029  
**Process Stage:** Submission of Supplemental Projects for Inclusion in the Local Plan – 4/26/2024

**Selected Solution:**

*At Carlisle Substation*

- Replace (1) 138 kV Oil Circuit Breaker.
- Replace (3) 138 kV disconnect switches.
- Replace associated relaying with microprocessor relays.
- Remove wave-trap and replace power line carrier communications with fiber communications.

*At Fieldstone Substation*

- Remove wave-trap.

*At Johnson Substation*

- Replace (1) 138 kV disconnect switch.
- Remove wave-trap and replace power line carrier communications with fiber communications.
- Connect fiber to existing microprocessor relays.

**Continued on next slide...**

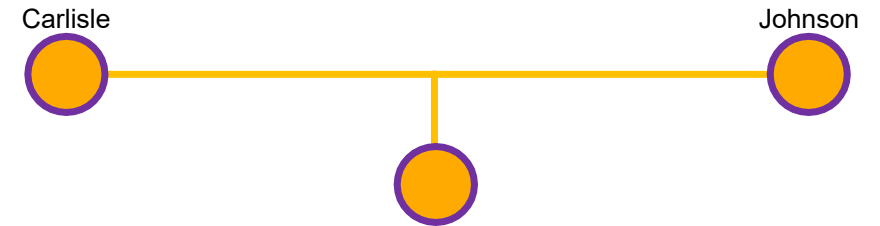

Legend	
500 kV	
345 kV	
138 kV	
69 kV	
34.5 kV	
23 kV	
New	



# ATSI Transmission Zone M-3 Process Carlisle – Johnson 138 kV Misoperation Relays

**Need Numbers:** ATSI-2023-029  
**Process Stage:** Submission of Supplemental Projects for  
Inclusion in the Local Plan – 4/26/2024

### Transmission Line Ratings:

Need #	Transmission Line / Substation Locations	Existing Circuit Ratings (SN / SE / WN / WE)	New Circuit Ratings (SN / SE / WN / WE)
ATSI-2023-029	Carlisle – Fieldstone Tap 138 kV Line Section	233 / 282 / 263 / 333	233 / 282 / 263 / 333
	Fieldstone Tap – Johnson 138 kV Line Section	225 / 282 / 263 / 333	233 / 282 / 263 / 333

**Estimated Project Cost:** \$2.2M  
**Projected In-Service:** 6/30/2025  
**Supplemental Project ID:** s3121.1

**Need Numbers:** ATSI-2023-041  
**Process Stage:** Submission of Supplemental Projects for Inclusion in the Local Plan – 4/26/2024  
**Previously Presented:** Need Meeting – 10/20/2023  
 Solution Meeting – 11/17/2023

**Project Driver:**  
*Equipment Material Condition, Performance and Risk*

**Specific Assumption Reference:**  
 System Performance Projects Global Factors

- System reliability and performance
- Substation/line equipment limits
- Upgrade Relay Schemes
- Obsolete and difficult to repair communication equipment (DTT, Blocking, etc.)
- Communication technology upgrades

- Problem Statement:**
- FirstEnergy has identified protection schemes using a certain vintage of relays and communication equipment that have a history of misoperation.
  - Proper operation of the protection scheme requires all the separate components perform adequately during a fault.
  - In many cases the protection equipment cannot be repaired due to a lack of replacement parts and available expertise in the outdated technology.
  - Transmission line ratings are limited by terminal equipment.

Continued on next slide...

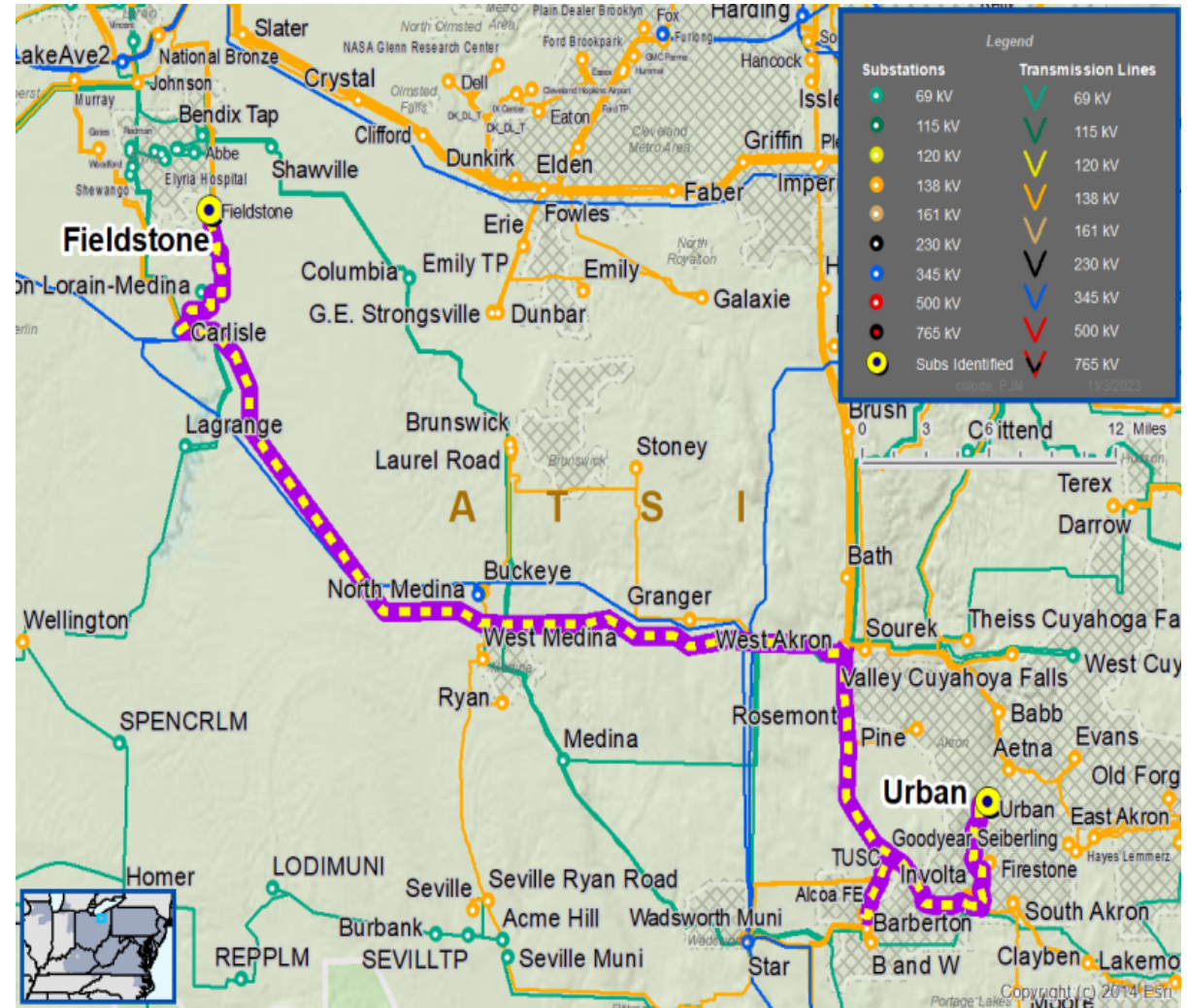



# ATSI Transmission Zone M-3 Process Firestone – Urban 138 kV Misoperation Relays

Need #	Transmission Line / Substation Locations	Existing Circuit Ratings (SN / SE / WN / WE)	Existing Conductor Ratings (SN / SE / WN / WE)
ATSI-2023-041	Firestone – Urban 138 kV Line	189 / 241 / 237 / 249	233 / 282 / 263 /333

**Need Numbers:** ATSI-2023-041  
**Process Stage:** Submission of Supplemental Projects for Inclusion in the Local Plan – 4/26/2024

**Selected Solution:**

*At Firestone Substation*

- Replace associated relaying with microprocessor relays.
- Replace wave-trap and power line carrier equipment.

*At Urban Substation*

- Replace (1) 138 kV Oil Circuit Breaker.
- Replace (3) 138 kV disconnect switches.
- Replace associated relaying with microprocessor relays.
- Replace wave-trap and power line carrier equipment.



Continued on next slide...

Legend	
500 kV	
345 kV	
138 kV	
69 kV	
34.5 kV	
23 kV	
New	



# ATSI Transmission Zone M-3 Process Firestone – Urban 138 kV Misoperation Relays

**Need Numbers:** ATSI-2023-041  
**Process Stage:** Submission of Supplemental Projects for  
Inclusion in the Local Plan – 4/26/2024

### Transmission Line Ratings:

Need #	Transmission Line / Substation Locations	Existing Circuit Ratings (SN / SE / WN / WE)	Existing Conductor Ratings (SN / SE / WN / WE)
ATSI-2023-041	Firestone – Urban 138 kV Line	189 / 241 / 237 / 249	233 / 282 / 263 / 333

**Estimated Project Cost:** \$2.5M  
**Projected In-Service:** 5/15/2026  
**Supplemental Project ID:** s3122.1

**Need Number:** ATSI-2020-044  
**Process Stage:** Submission of Supplemental Project for Inclusion in the Local Plan – 4/26/2024  
**Previously Presented:** Solution Meeting 01/19/2024  
 Need Meeting 11/20/2020

**Project Driver:**

*Equipment Material Condition, Performance and Risk*

**Specific Assumption Reference:**

Line Condition Rebuild / Replacement

- Aged or deteriorated transmission line structures
- Negatively impact customer outage frequency and/or durations
- Demonstrate an increasing trend in maintenance findings and/or costs
- Transmission line ratings are limited by terminal equipment

**Problem Statement:**

- Henrietta-Johnson 69 kV Transmission Line is approximately 16 miles in length.
- Line survey in 2020 showed a structure reject rate of 43% (93 of 218). The primary reasons for reject were wood pole deterioration, woodpecker holes, ground system damage, and decay damage.
- Worst performing transmission circuit in ATSI.
- Growing trend in unscheduled interruptions with 20 equipment failure caused outages in the past 5 years which have historically impacted approximately 9,200 customers. The majority of outage causes are related to Failed AC Circuit Equipment (conductor, crossarm, static wire, insulator, etc.).
- Transmission line switches are obsolete and limiting the transmission line rating.

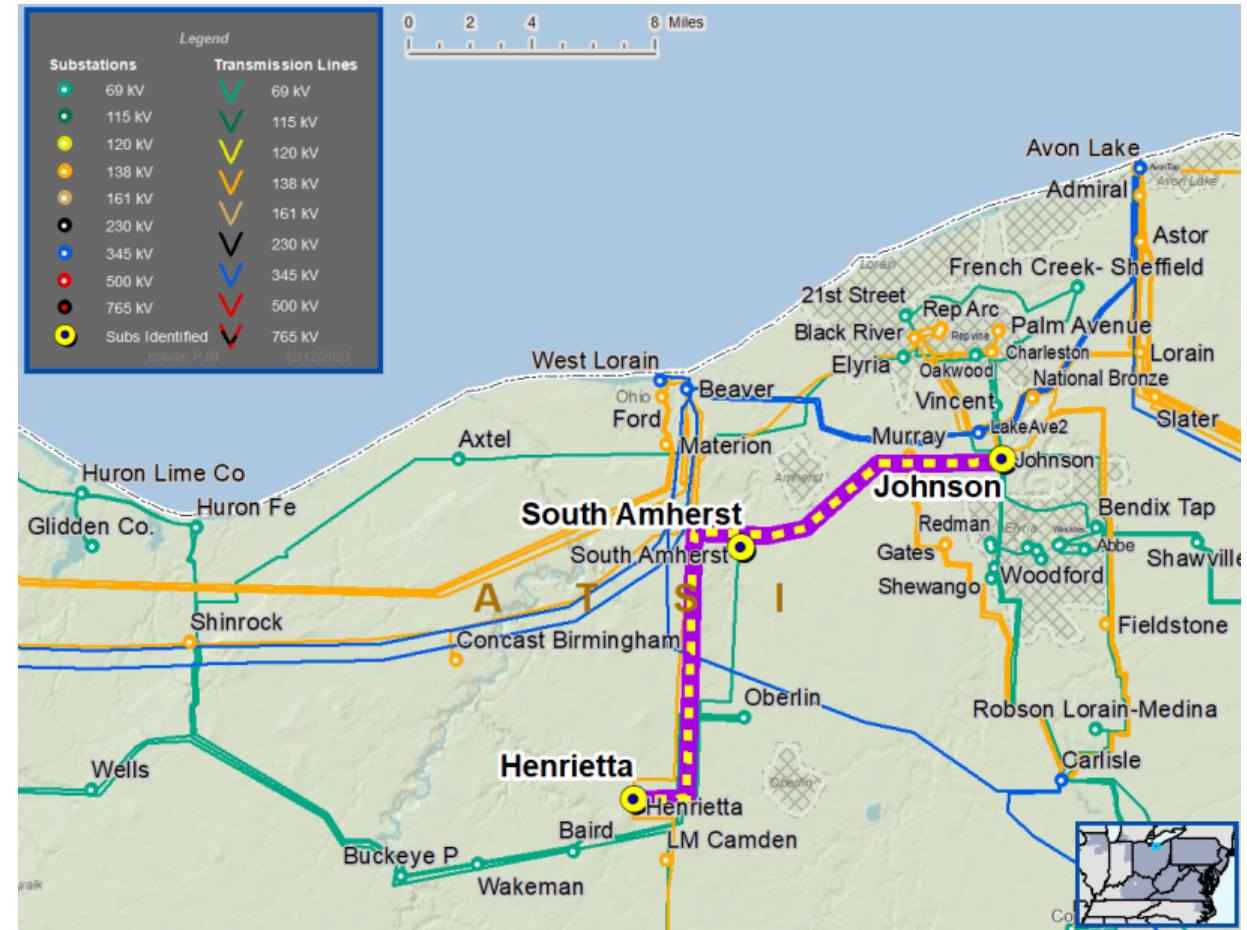



**Need Numbers:** ATSI-2020-044  
**Process Stage:** Submission of Supplemental Projects for Inclusion in the Local Plan – 4/26/2024

**Selected Solution:**

***Henrietta – Johnson 69 kV Line***

- Replace wood structures and rebuild 12.1 miles of line with new conductor.
- Reconductor 1 mile of line on steel structures.
- Replace (2) 600 A switches with 1200 switches at South Amherst.
- Replace limiting substation conductor at Henrietta

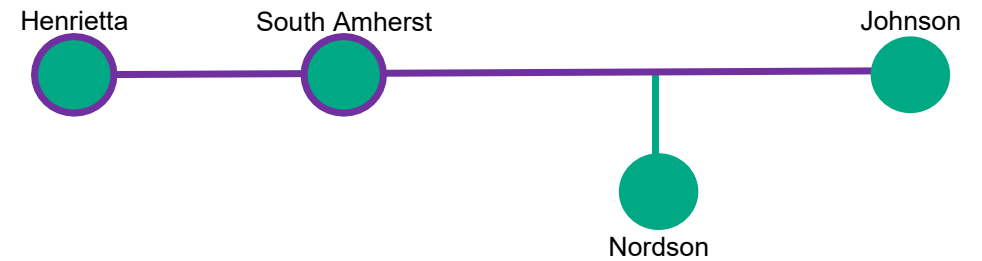

Legend	
500 kV	
345 kV	
138 kV	
69 kV	
34.5 kV	
23 kV	
New	

Continued on next slide...



# ATSI Transmission Zone M-3 Process Henrietta – Johnson 69 kV

**Need Numbers:** ATSI-2020-044  
**Process Stage:** Submission of Supplemental Project for Inclusion in the Local Plan – 4/26/2024

**Transmission Line Ratings:**

Need #	Transmission Line / Substation Locations	Existing Circuit Ratings (SN/ SE / SLD / WN / WE / WLD)	New Circuit Ratings (SN / SE / SLD / WN / WE / WLD)
ATSI-2020-044	Henrietta – South Amherst 69 kV Line Section	80 / 96 / 108 / 90 / 114 / 123	111 / 134 / 151 / 125 / 159 / 171
	South Amherst – Nordson Tap 138 kV Line Section	45 / 54 / 60 / 51 / 65 / 69	111 / 134 / 151 / 125 / 159 / 171
	Nordson Tap – Johnson 138 kV Line Section	80 / 96 / 108 / 90 / 114 / 123	111 / 134 / 151 / 125 / 159 / 171

**Estimated Project Cost:** \$18M  
**Projected In-Service:** 12/31/2025  
**Supplemental Project ID:** s3192.1

**Need Number:** ATSI-2023-027  
**Process Stage:** Submission of Supplemental Projects for Inclusion in the Local Plan – 4/26/2024  
**Previously Presented:** Solution Meeting 01/19/2024  
 Need Meeting 11/17/2023

**Project Driver:**

*Equipment Material Condition, Performance and Risk*

**Specific Assumption Reference:**

System Performance Projects Global Factors

- Substation/line equipment limits
- Substation Condition Rebuild/Replacement
- Circuit breakers and other fault interrupting devices

**Problem Statement:**

- The 69 kV Oil Circuit Breaker B-30, associated disconnect switches and protective relaying at Newton Falls is aging with increasing maintenance concerns. The equipment is 48 years old.
- Transmission line ratings are limited by terminal equipment.



Continued on next slide...

Need #	Transmission Line / Substation Locations	Existing Line Rating (SN / SE / WN / WE)	Existing Conductor Rating (SN / SE / WN / WE)
ATSI-2023-027	Newton Falls – NF Muni Tap 69 kV Line Section	76 / 92 / 87 / 93	76 / 92 / 87 / 111



# ATSI Transmission Zone M-3 Process Newton Falls 69 kV Breaker

**Need Numbers:** ATSI-2023-027  
**Process Stage:** Submission of Supplemental Projects for Inclusion in the Local Plan – 4/26/2024

**Selected Solution:**

**At Newton Falls Substation**

- For Garrettsville South 69 kV Line, replace circuit breaker B30.
- Replace (2) associated disconnect switches.
- Replace associated relaying with microprocessor relays.

**Transmission Line Ratings:**

Existing Ratings (SN/SE/SLD/WN/WE/WLD): 76/92/103/87/93/103 MVA  
 New Ratings (SN/SE/SLD/WN/WE/WLD): 76/92/104/87/111/120 MVA

**Estimated Project Cost:** \$1.0M  
**Projected In-Service:** 02/02/2024  
**Supplemental Project ID:** s3193.1

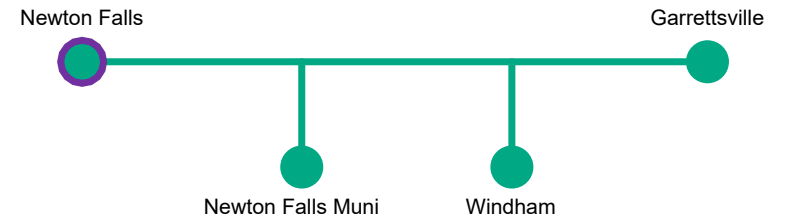

Legend	
500 kV	
345 kV	
138 kV	
69 kV	
34.5 kV	
23 kV	
New	



# AMPT Projects in ATSI Transmission Zone M3 Process Pioneer, OH

**Need Number:** AMPT-2022-002  
**Process Stage:** Submission of Supplemental Projects for Inclusion in the Local Plan – 4/26/2024  
**Previously Presented:** Solution Meeting – 11/17/2023  
Need Meeting – 2/18/2022

**Supplemental Project Driver(s):**

Customer Service

**Specific Assumption Reference(s):** AMPT’s “Transmission Facilities Interconnection Requirements” document.

**Problem Statement:**

The existing interconnection is an approximately 2 mile radial 69 kV tap off ATSI’s East Fayette-Exit 2 69 kV line which supplies the Pioneer 69/12 kV substation.

The current peak load at Pioneer is 8 MW. A 2<sup>nd</sup> supply is needed per AMPT interconnection requirements criteria. The radial supply presents a single point of failure that jeopardizes reliability for the village.

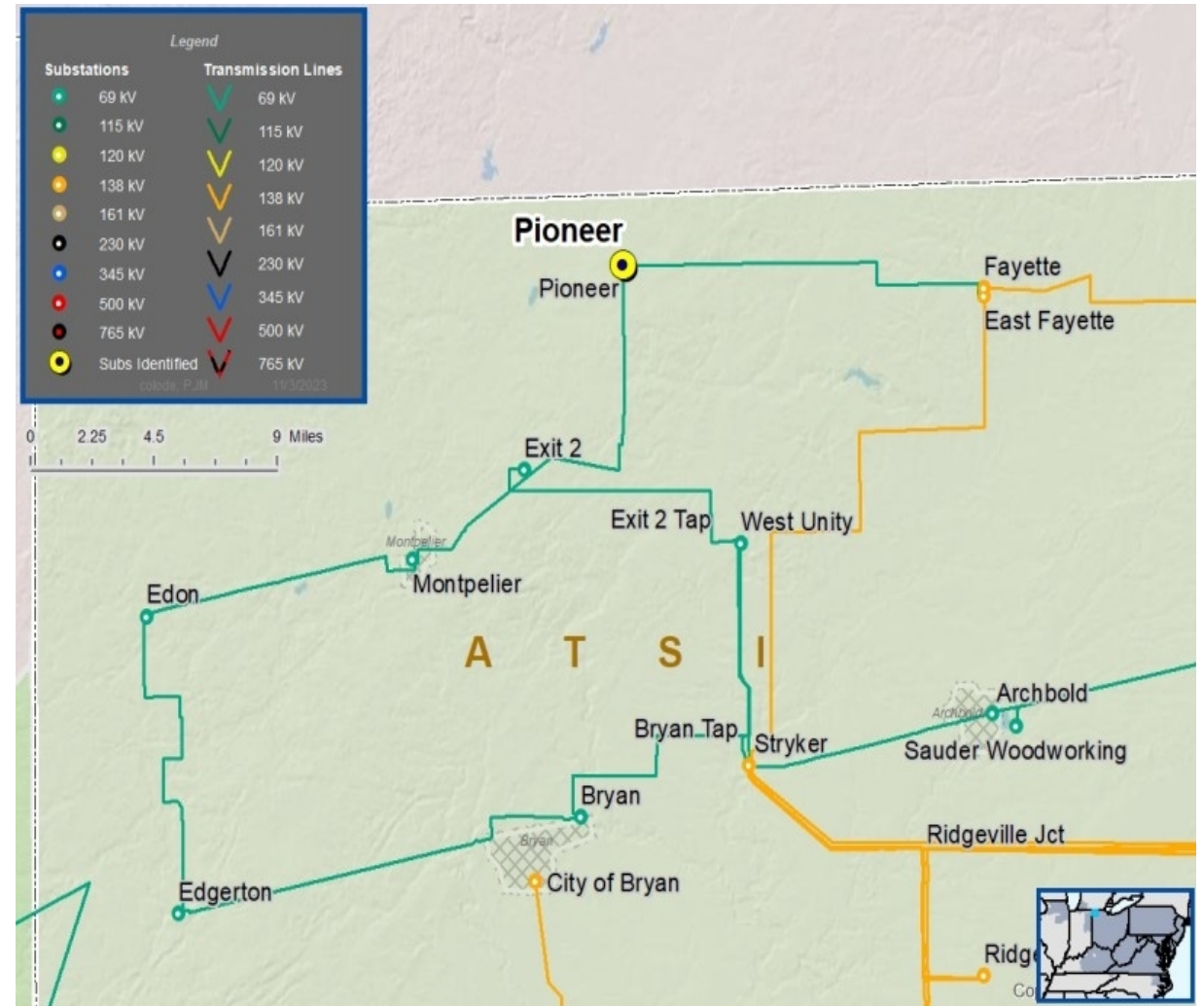



# AMPT Projects in ATSI Transmission Zone M3 Process Pioneer, OH

**Need Number:** AMPT-2022-002  
**Process Stage:** Submission of Supplemental Projects for Inclusion in the Local Plan – 4/26/2024

## Selected Solution: (ATSI):

### Snyder 69 kV substation (s3117.4 / \$5.4M)

- Expand the Snyder Substation from five to a six-breaker ring bus by adding one 69 kV circuit breaker to accommodate the Kexon-Bruce R. Kidston-Snyder 69 kV Line terminal (i.e., Kexon- Snyder #2) and install a dead-end structure just outside Snyder Substation to provide a termination point for the new line.
- Revise line relay settings to Kexon (formerly E Fayette exit)
- Install standard BES line relay panel with on the new line exit for the Kexon-Snyder #2 69 kV Line

### Stryker (s3117.5 / \$6.4M)

- Install 2<sup>nd</sup> 138/69 kV transformer, adjust all 69 & 138 kV relays as required, integrate the new transformer protection to the system.
- Install one 138 kV bus tie breaker

### East Fayette-Snyder 69 kV Line (s3117.6 / \$0.8M)

- Split the E Fayette-Snyder 69 kV Line between structure # 191 & 192 to loop in the AMPT Kexon Substation.
- Revise relay settings at E Fayette and Snyder substations
- Install a jumper between the new E. Fayette-Kexon & Snyder-Kexon #1 69 kV Line with inline normally open SCADA controlled switch

**Estimated Project Cost:** \$12.6 M

**Projected In-Service:** 5/31/2027

**Supplemental Project ID:** s3117.4, s3117.5, s3117.6

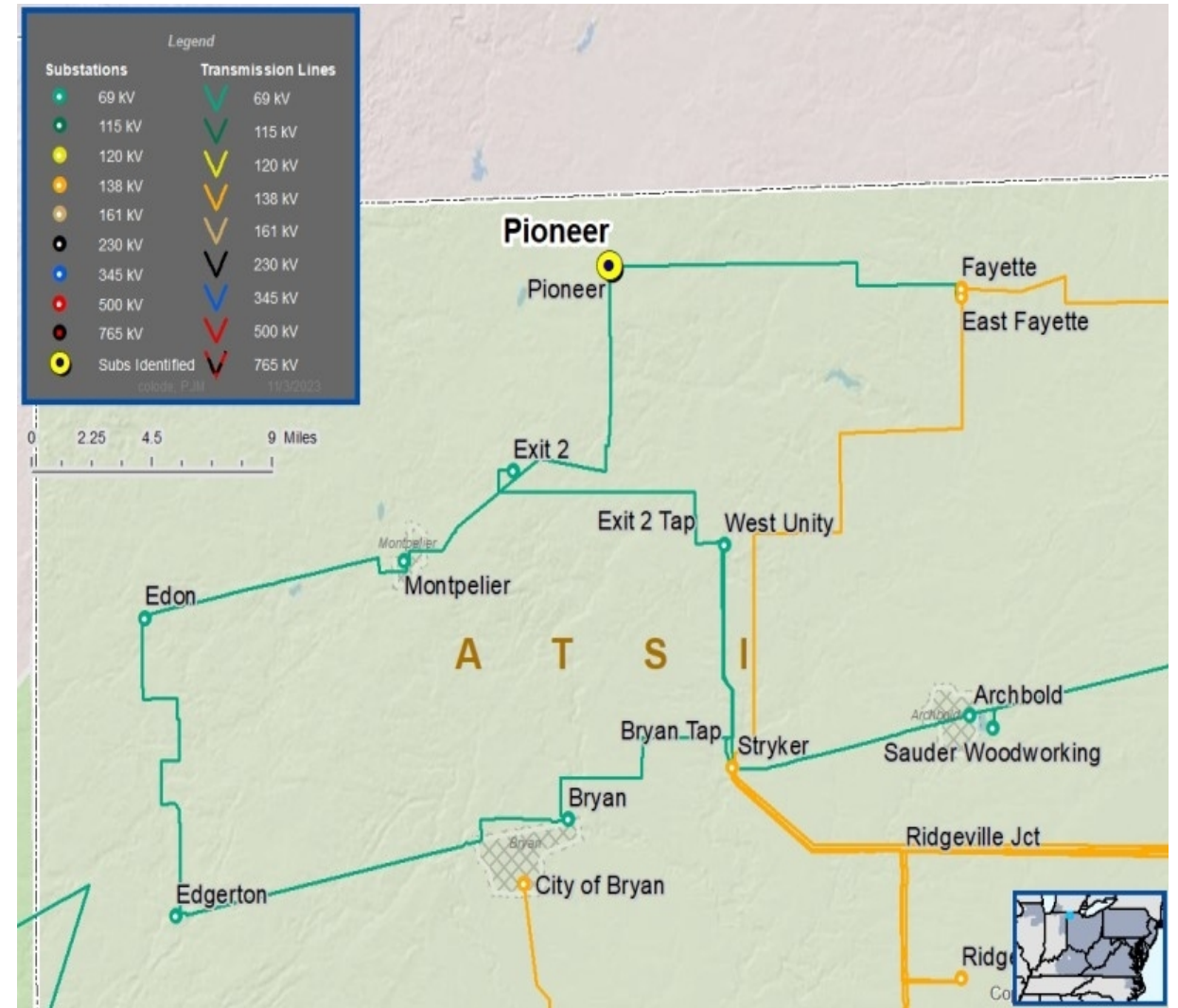

**Need Number:** ATSI-2020-028  
**Process Stage:** Submission of Supplemental Projects for Inclusion in the Local Plan – 9/10/2024  
**Previously Presented:** Need Meeting – 08/14/2020  
 Solutions Meeting – 03/15/2024

**Supplemental Project Driver(s):**  
*Equipment Material Condition, Performance and Risk*  
**Specific Assumption Reference(s)**

Line Condition Rebuild / Replacement

- Aged or deteriorated transmission line structures
- Negatively impact customer outage frequency and/or durations
- Demonstrate an increasing trend in maintenance findings and/or costs
- Transmission line ratings are limited by terminal equipment.

**Problem Statement:**

Midway – Richland – Wauseon 138 kV (~33.5 miles) Transmission Line:

- Existing conductor has a history of failure due to conductor vibration resulting in thermal overload and corrosion of steel core.
- Original porcelain insulators from 1948 construction are aged and exhibiting wear.
- Comprehensive aerial inspection was completed in 2020 and shows a rising negative trend in required maintenance with 160 structures that presently require repair for structure damage static wire damage, broken insulators, and broken or overheated conductor.
- Growing trend in unscheduled interruptions on this line with five equipment caused outages in the past ten years.
- Condition of static wire is deteriorating which may be contributing to rise in lightning caused outages.

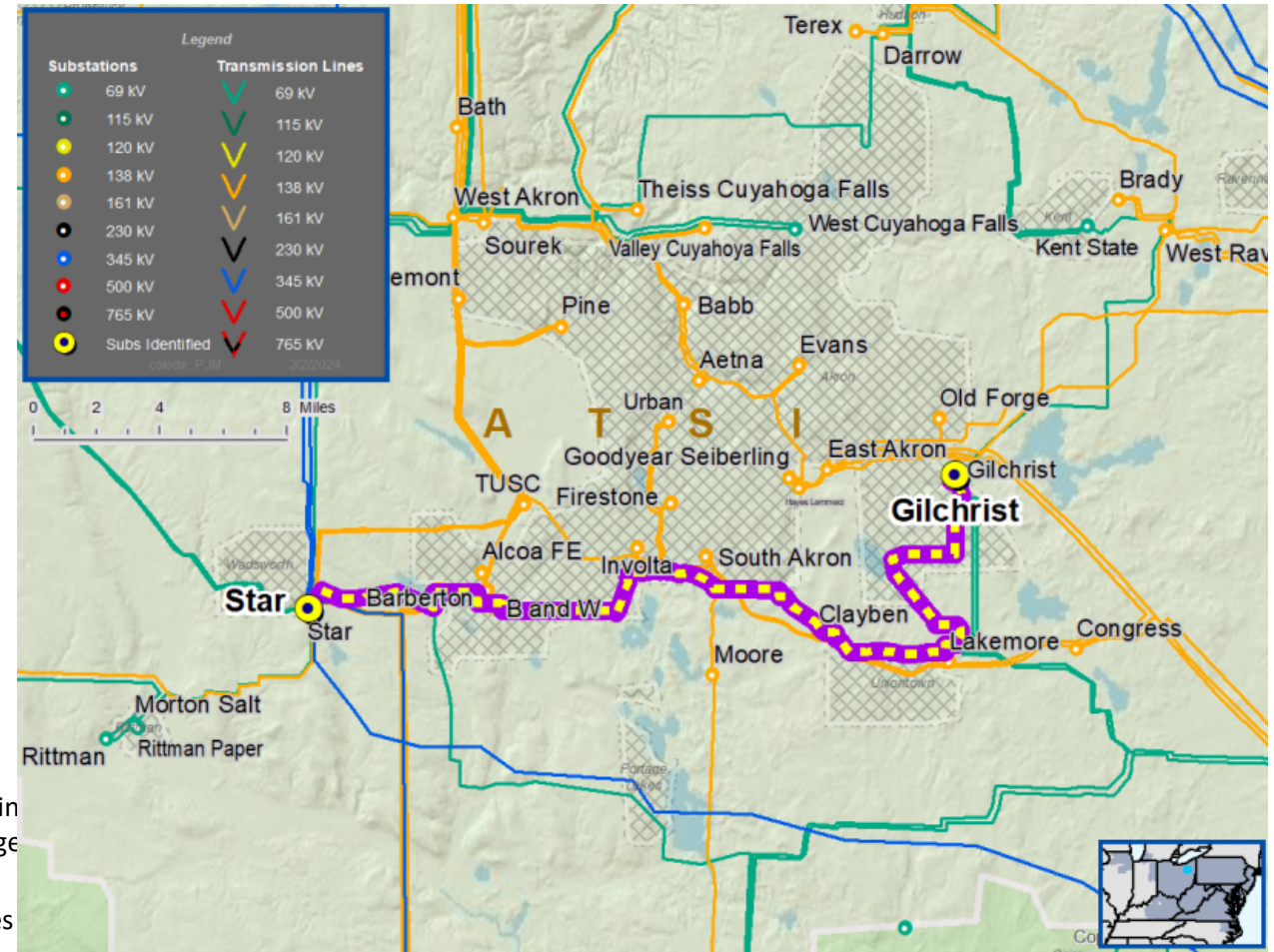





**Need Number:** ATSI-2020-028  
**Process Stage:** Submission of Supplemental Projects for Inclusion in the Local Plan – 9/10/2024

**Selected Solution:**

Midway – Richland – Wauseon 138 kV Line Reconductor

- Project scope assumes completion of Midway – Richland – Wauseon 138 kV Line – Eliminate three-terminal line project is complete (s1698) (projected ISD: 4/12/2023).
- Reconductor the Richland – Wauseon 138 kV Line from Richland Substation to structure 215, approximately 21.2 miles.
- Reconductor the Midway – Richland – Wauseon 138 kV Line from the Midway Substation to structure 215, approximately 12.2 miles.
- Install OPGW from the Midway Substation to the Richland Substation, approximately 21.2 miles.
- Upgrade substation conductor at Midway Substation and Wauseon Substation.

**Transmission Line Ratings:**

Midway – Wauseon 138 kV Line

- Before Proposed Solution: 160 / 192 / 180 / 228 MVA (SN/SE/WN/WE)
- After Proposed Solution: 161 / 194 / 182 / 230 MVA (SN/SE/WN/WE)

Richland – Wauseon 138 kV Line

- Before Proposed Solution: 160 / 192 / 180 / 228 MVA (SN/SE/WN/WE)
- After Proposed Solution: 161 / 194 / 182 / 230 MVA (SN/SE/WN/WE)

**Estimated Project Cost:** \$44 M  
**Projected In-Service:** 12/31/2026  
**Supplemental Project ID:** s3370.1

## ATSI Transmission Zone M-3 Process Midway – Richland – Wauseon 138 kV Line

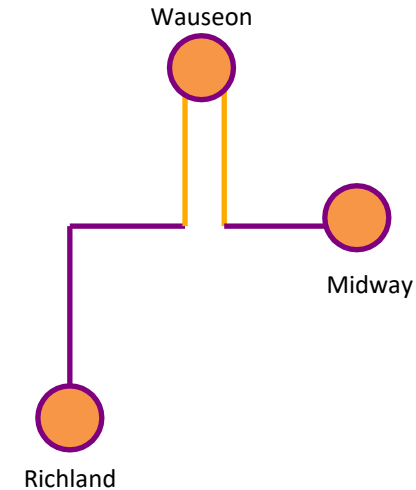

Legend	
500 kV	
345 kV	
138 kV	
69 kV	
34.5 kV	
23 kV	
New	

**Need Number:** ATSI-2020-029  
**Process Stage:** Submission of Supplemental Projects for Inclusion in the Local Plan – 9/9/2024  
**Previously Presented:** Need Meeting – 08/14/2020  
 Solutions Meeting – 03/15/2024

**Supplemental Project Driver(s):**

*Equipment Material Condition, Performance and Risk*

**Specific Assumption Reference(s)**

**Line Condition Rebuild / Replacement**

- Aged or deteriorated transmission line structures
- Negatively impact customer outage frequency and/or durations
- Demonstrate an increasing trend in maintenance findings and/or costs
- Transmission line ratings are limited by terminal equipment.

**Problem Statement:**

Napoleon – Richland – Stryker 138 kV (~32 miles) Transmission Line:

- Existing conductor has a history of failure due to conductor vibration resulting in thermal overload and corrosion of steel core.
- Existing line is constructed on double circuit lattice towers shared with the Midway – Richland – Wauseon 138 kV Line.
- Comprehensive aerial inspection was completed in 2020 and shows a rising negative trend in required maintenance with 130 structures that presently require repair for worn static wire, damaged attachment hardware, and broken or flashed insulators.
- Growing trend in unscheduled interruptions on this line with six equipment caused outages in the past ten years.

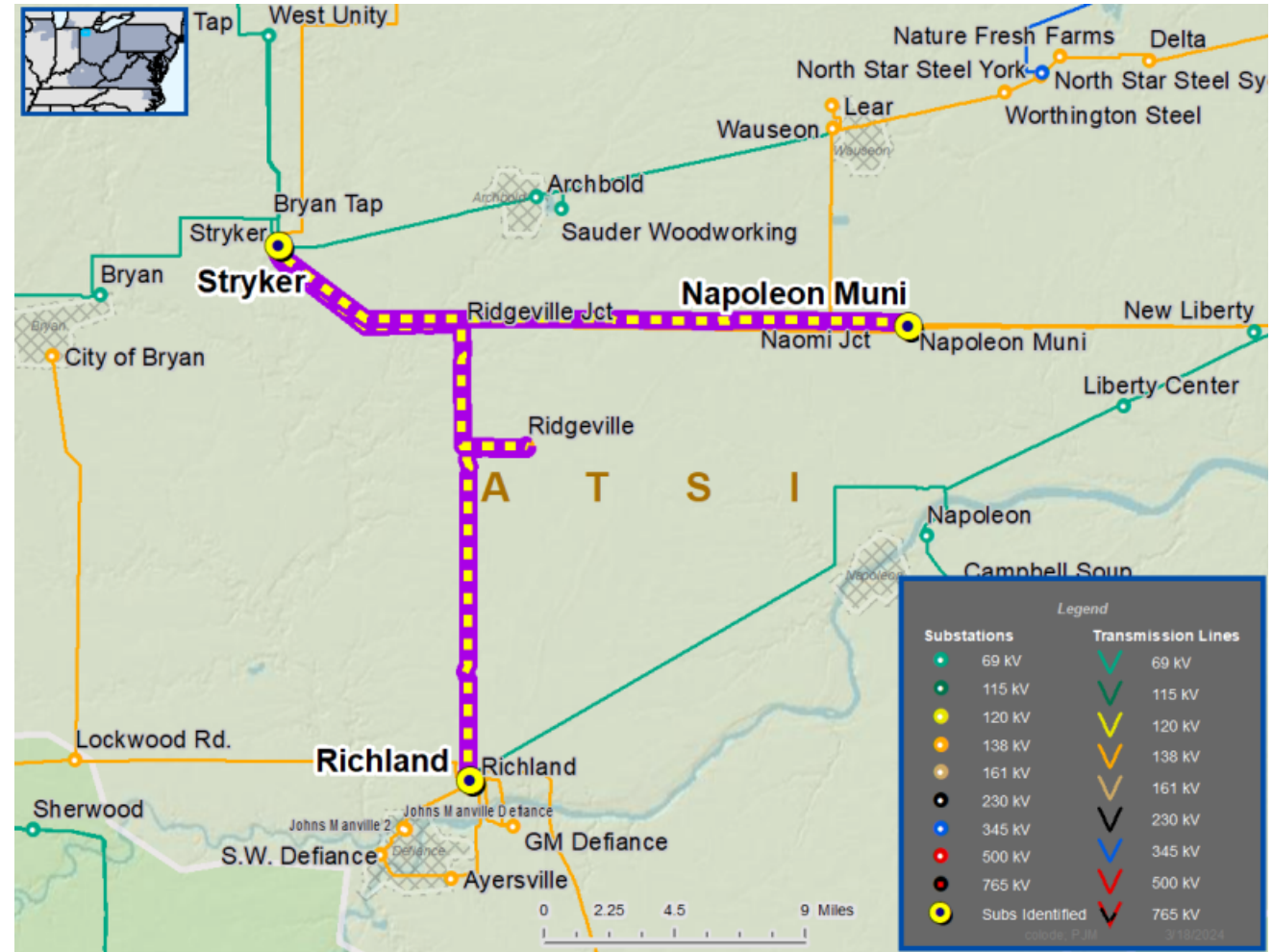



**Need Number:** ATSI-2020-029  
**Process Stage:** Submission of Supplemental Projects for Inclusion in the Local Plan – 9/10/2024

**Selected Solution:**

Napoleon – Richland – Stryker 138 kV Line Reconductor

- Reconductor the Napoleon Muni Northside – Stryker 138 kV Line from Napoleon Substation to the Stryker Substation, approximately 17.1 miles.
- Reconductor the Richland – Stryker 138 kV Line from Richland Substation to Structure 265, approximately 11.8 miles.
- Replace one 138 kV breaker at Richland Substation.
- At AMPT (Napoleon) Sullivan Station:
  - Revise remote end relay settings to accommodate new conductor

**Transmission Line Ratings:**

Ridgeville – Stryker 138 kV Line

- Before Proposed Solution: 160 / 192 / 180 / 228 MVA (SN/SE/WN/WE)
- After Proposed Solution: 161 / 194 / 182 / 230 MVA (SN/SE/WN/WE)

Richland – Ridgeville 138 kV Line

- Before Proposed Solution: 161 / 194 / 182 / 230 MVA (SN/SE/WN/WE)
- After Proposed Solution: 161 / 194 / 182 / 230 MVA (SN/SE/WN/WE)

Napoleon Muni – Stryker 138 kV Line

- Before Proposed Solution: 161 / 194 / 182 / 230 MVA (SN/SE/WN/WE)
- After Proposed Solution: 161 / 194 / 182 / 230 MVA (SN/SE/WN/WE)

**Estimated Project Cost:** \$12 M (ATSI=\$11.9M, AMPT=\$0.1M)  
**Projected In-Service:** 12/31/2026  
**Supplemental Project ID:** s3371.1

## ATSI Transmission Zone M-3 Process Napoleon – Richland – Stryker 138 kV Line

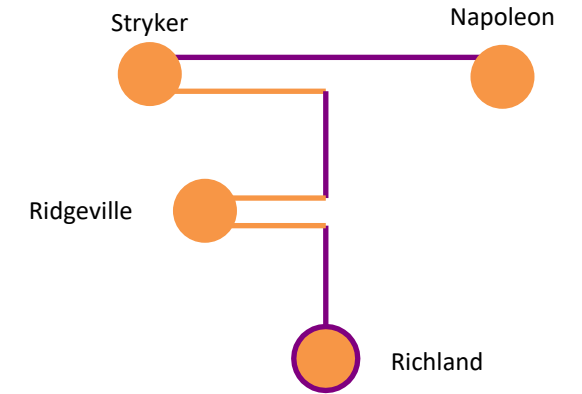

Legend	
500 kV	
345 kV	
138 kV	
69 kV	
34.5 kV	
23 kV	
New	

**Need Number:** ATSI-2020-032  
**Process Stage:** Submission of Supplemental Projects for Inclusion in the Local Plan – 9/10/2024  
**Previously Presented:** Need Meeting – 08/14/2020  
 Solutions Meeting – 03/15/2024

**Supplemental Project Driver(s):**  
*Equipment Material Condition, Performance and Risk*  
**Specific Assumption Reference(s)**

**Line Condition Rebuild / Replacement**

- Aged or deteriorated transmission line structures
- Negatively impact customer outage frequency and/or durations
- Demonstrate an increasing trend in maintenance findings and/or costs
- Transmission line ratings are limited by terminal equipment.

**Problem Statement:**

Dilworth – Maysville 69 kV (~11.4 miles) Transmission Line Rehab project is being proposed due to the following:

- Line was originally constructed in 1947. The average age of structures on this line are 58 years old. FirstEnergy has historically experienced an average age of reject for wood poles to be 48.7 years.
- Line survey in 2019 showed a structure reject rate of 57% (166 of 293). The primary reasons for reject were wood pole deterioration, broken static wire, woodpecker holes, broken conductor strands.
- Existing conductor has a history of failure due to conductor vibration resulting in thermal overload and corrosion of steel core.
- Environmental conditions on ROW causes difficulties for routine maintenance, vegetation management and outage restoration.
- Growing trend in unscheduled interruptions with 10 equipment caused outages in the past 2 years which have historically impacted ~20,000 customers.
- Obsolete line switch (A-212 N.O.) is no longer supported by the manufacturer.

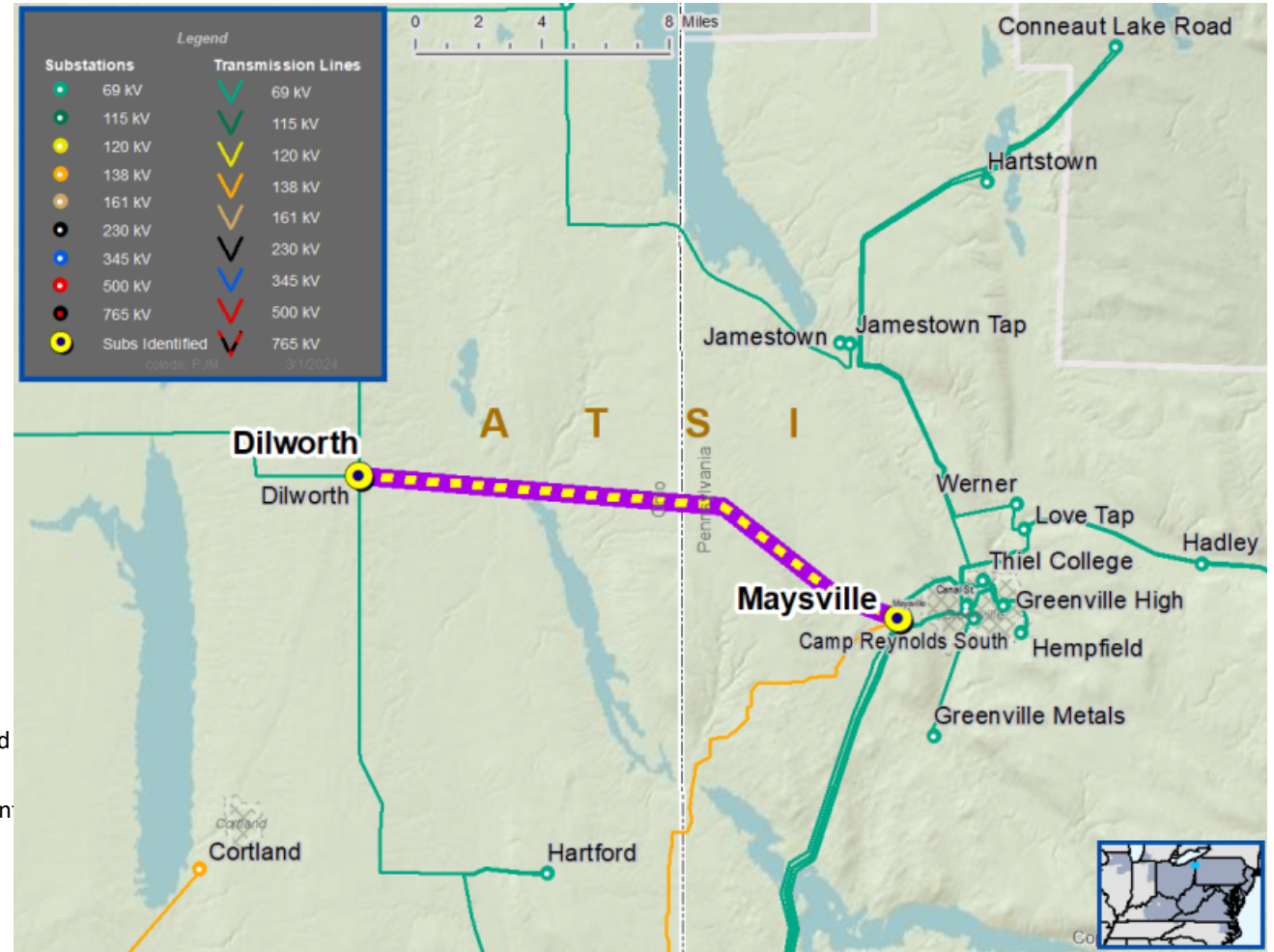



**Need Number:** ATSI-2020-032  
**Process Stage:** Submission of Supplemental Projects for Inclusion in the Local Plan – 9/10/2024

**Selected Solution:**

Dilworth – Maysville 69 kV Line Rebuild

- Rebuild an approximately 11.4-mile section of the Dilworth – Maysville 69 kV Line from Dilworth Substation to Andover Substation.
- Replace the obsolete normally open line switch.

**Transmission Line Ratings:**

Dilworth – Andover 69 kV Line

- Before Proposed Solution: 36 / 43 / 40 / 51 MVA (SN/SE/WN/WE)
- After Proposed Solution: 80 / 96 / 90 / 114 MVA (SN/SE/WN/WE)

**Estimated Project Cost:** \$25.2 M  
**Projected In-Service:** 12/31/2025  
**Supplemental Project ID:** s3372.1

# ATSI Transmission Zone M-3 Process Dilworth – Maysville 69 kV Line



Legend	
500 kV	
345 kV	
138 kV	
69 kV	
34.5 kV	
23 kV	
New	

**Need Number:** ATSI-2022-028

**Process Stage:** Submission of Supplemental Projects for Inclusion in the Local Plan – 9/10/2024

**Process Stage:** Need Meeting– 10/14/2022  
Solutions Meeting – 02/16/2024

**Supplemental Project Driver(s):**

*Equipment Material Condition, Performance and Risk*

**Specific Assumption Reference(s)**

**Line Condition Rebuild / Replacement**

- Aged or deteriorated transmission line structures
- Negatively impact customer outage frequency and/or durations
- Demonstrate an increasing trend in maintenance findings and/or costs
- Transmission line ratings are limited by terminal equipment.

**Problem Statement:**

The Gilchrist-Star 69 kV Line is approximately 25 miles in length:

- Line survey in 2020 showed a structure reject rate of 89% (413 of 461). The primary reasons for reject were wood pole deterioration, woodpecker holes, ground system damage, and decay damage.
- Since 2017, there has been a total of eight (8) momentary and six (6) sustained unscheduled outages on the line.
- Transmission line switches are obsolete and limiting the transmission line rating.

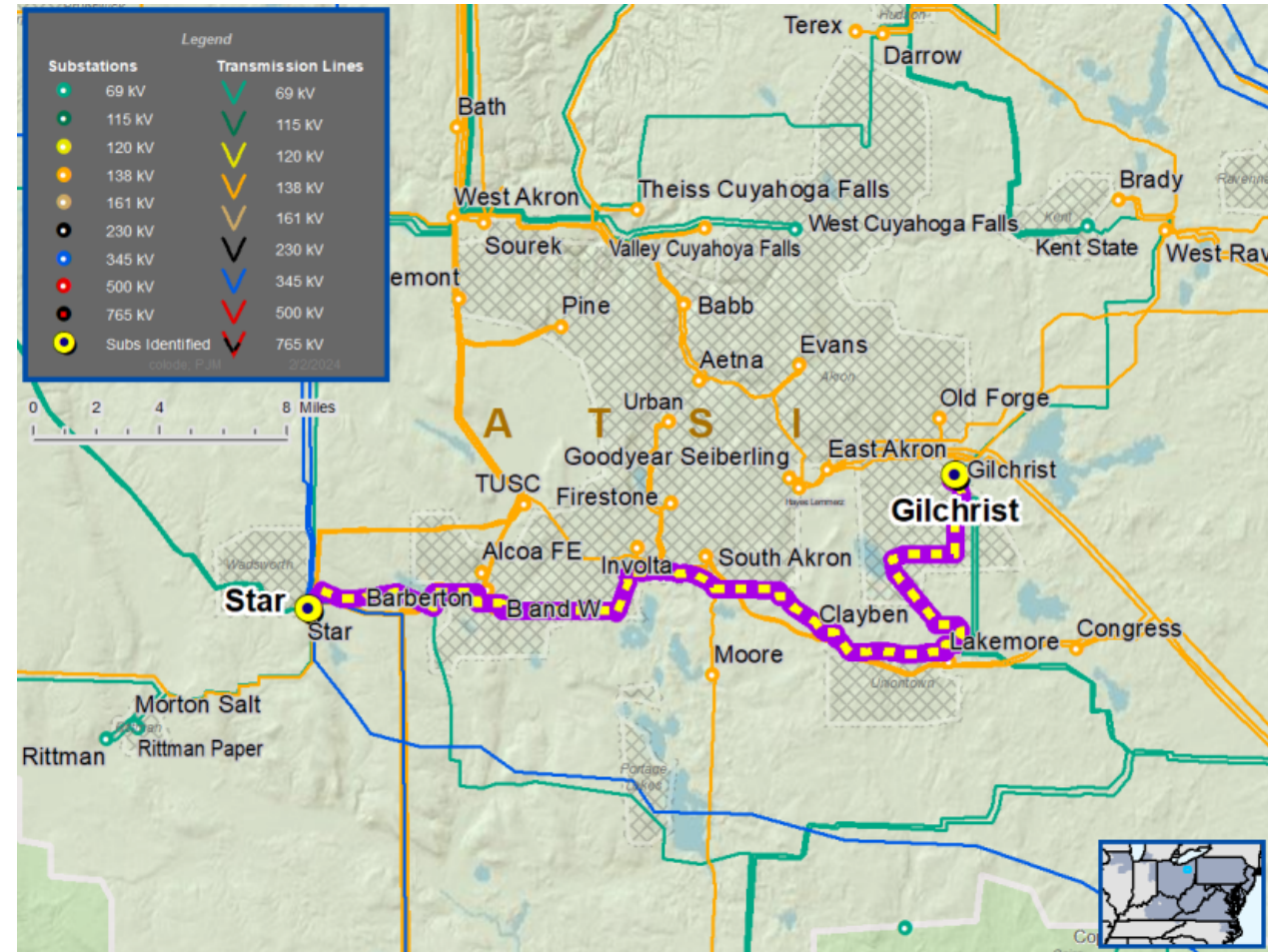



**Need Number:** ATSI-2022-028  
**Process Stage:** Submission of Supplemental Projects for Inclusion in the Local Plan – 9/10/2024

**Selected Solution:**

Gilchrist-Star 69 kV Line

- Rebuild the Gilchrist – Star 69 kV Line with new conductor.
- Replace A-42, A-87, A-86, A-38 switches with new switches equipped with SCADA Control & Motor Operation.

Gilchrist Substation

- Replace 69 kV breaker B23

**Transmission Line Ratings:**

Gilchrist – McKnights 69 kV Line

- Before Proposed Solution: 80 / 96 / 90 / 114 MVA (SN/SE/WN/WE)
- After Proposed Solution: 111 / 134 / 125 / 159 MVA (SN/SE/WN/WE)

McKnights – Rochling Automotive 69 kV Line

- Before Proposed Solution: 80 / 96 / 90 / 114 MVA (SN/SE/WN/WE)
- After Proposed Solution: 111 / 134 / 125 / 159 MVA (SN/SE/WN/WE)

Rochling Automotive – Portage Lakes 69 kV Line

- Before Proposed Solution: 74 / 76 / 83 / 83 MVA (SN/SE/WN/WE)
- After Proposed Solution: 111 / 134 / 125 / 159 MVA (SN/SE/WN/WE)

Portage Lakes – Babcock and Wilcox PGG 69 kV Line

- Before Proposed Solution: 74 / 76 / 83 / 83 MVA (SN/SE/WN/WE)
- After Proposed Solution: 111 / 134 / 125 / 159 MVA (SN/SE/WN/WE)

Babcock and Wilcox PGG – Star 69 kV Line

- Before Proposed Solution: 74 / 76 / 83 / 83 MVA (SN/SE/WN/WE)
- After Proposed Solution: 111 / 134 / 125 / 159 MVA (SN/SE/WN/WE)

## ATSI Transmission Zone M-3 Process Gilchrist – Star 69 kV Line

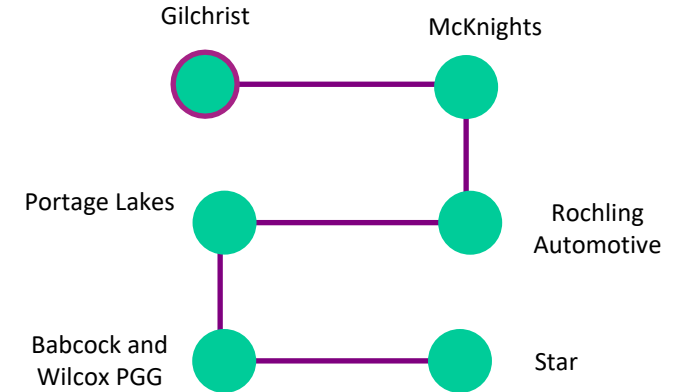

Legend	
500 kV	
345 kV	
138 kV	
69 kV	
34.5 kV	
23 kV	
New	



**Need Number:** ATSI-2022-028  
**Process Stage:** Submission of Supplemental Projects for Inclusion in the Local Plan – 9/10/2024

**Estimated Project Cost:** \$62.5 M  
**Projected In-Service:** 12/1/2027  
**Supplemental Project ID:** s3359.1

## ATSI Transmission Zone M-3 Process Gilchrist – Star 69 kV Line

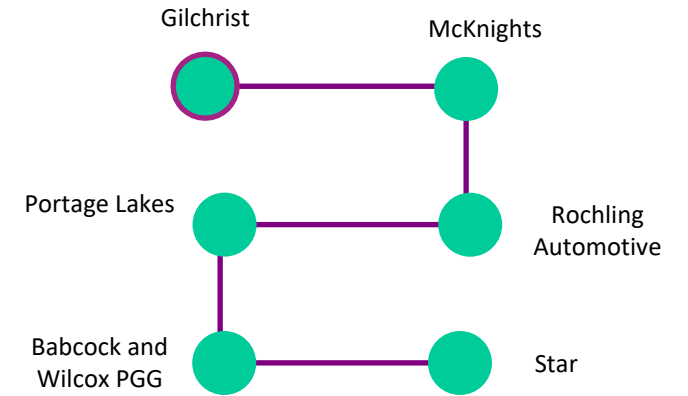

Legend	
500 kV	
345 kV	
138 kV	
69 kV	
34.5 kV	
23 kV	
New	



**Need Numbers:** ATSI-2023-036

**Process Stage:** Submission of Supplemental Projects for Inclusion in the Local Plan – 9/10/2024

**Previously Presented:** Need Meeting – 11/17/2023  
Solutions Meeting – 02/16/2024

**Project Driver:**

*Equipment Material Condition, Performance and Risk*

**Specific Assumption Reference:**

System Performance Projects Global Factors

- Substation/line equipment limits
- Substation Condition Rebuild/Replacement
- Circuit breakers and other fault interrupting devices

**Problem Statement:**

- The 138 kV Oil Circuit Breaker B-52, B-55, B-58, B-59 and B-60, Circuit Switchers CS-136 and CS-137, associated disconnect switches and protective relaying at Galion Substation are aging with increasing maintenance concerns. The equipment is 50 years old.
- Transmission line ratings are limited by terminal equipment.

Continued on next slide...

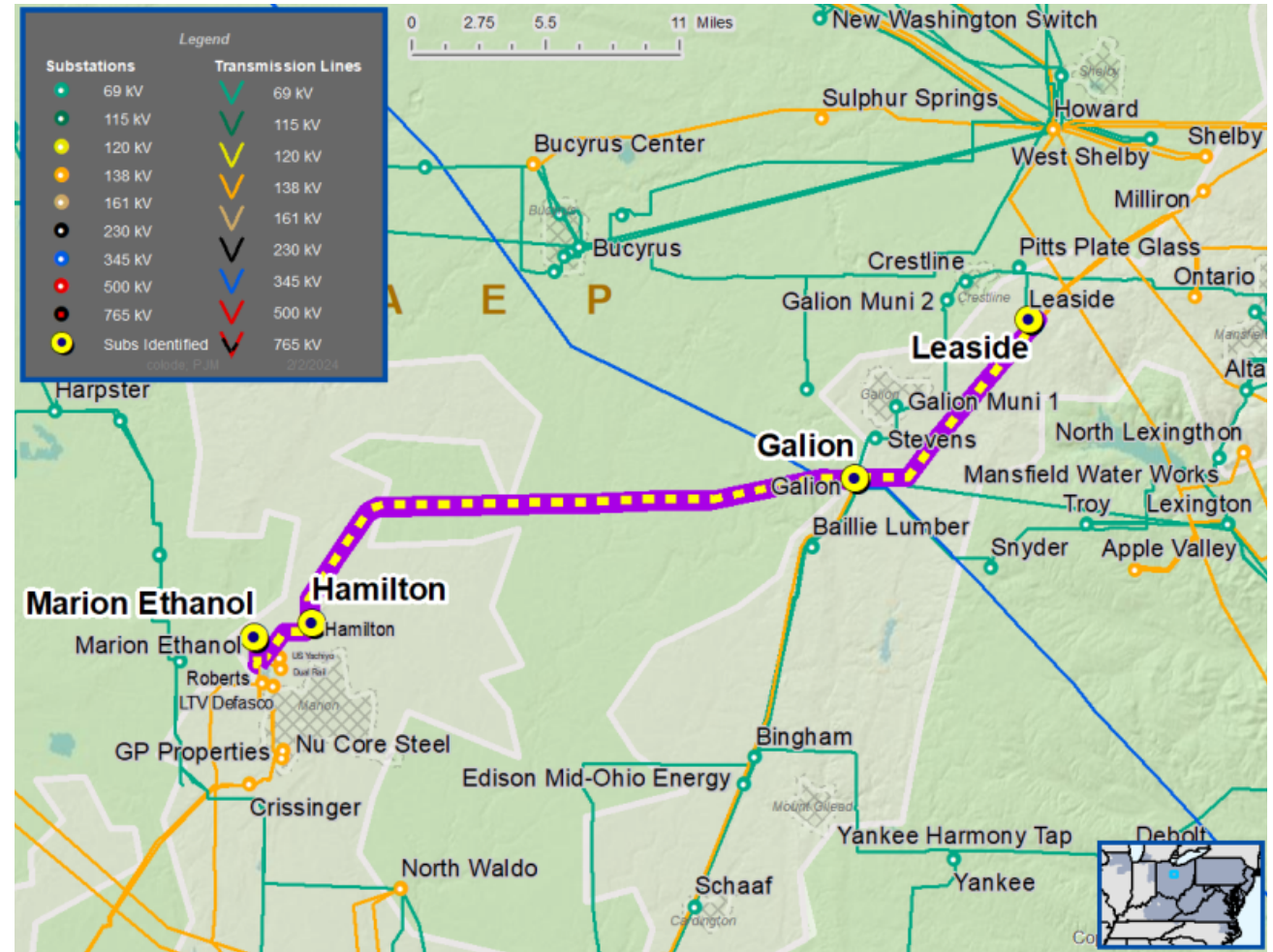



# ATSI Transmission Zone M-3 Process Galion 138 kV Breakers

Need #	Transmission Line / Substation Locations	Existing Line Rating (SN / SE / WN / WE)	Existing Conductor Rating (SN / SE / WN / WE)
ATSI-2023-036	Galion - Leaside 138 kV Line	251 / 290 / 250 / 306	251 / 290 / 250 / 306
	Galion – Hamilton Tap 138 kV Line Section	195 / 209 / 217 / 229	200 / 242 / 226 / 286
	Galion – Marion Ethanol Tap 138 kV Line Section	160 / 192 / 180 / 228	160 / 192 / 180 / 228
	Galion 345/138 kV Transformer #3	458 / 478 / 478 / 478	606 / 695 / 735 / 828
	Galion 345/138 kV Transformer #4	400 / 478 / 478 / 478	618 / 729 / 743 / 864

**Need Number:** ATSI-2023-036

**Process Stage:** Submission of Supplemental Projects for Inclusion in the Local Plan – 9/10/2024

**Selected Solution:**

At Galion:

- Replace 138 kV breakers B-52, B-55, B-58, B-59 and B-60 as well as circuit switchers CS-136 and CS-137.
- Replace and install associated disconnect switches and protective relaying.
- Replace limiting substation conductor.

**Transmission Line Ratings:**

Galion – Leaside 138 kV Line

- Before Proposed Solution: 251 / 290 / 250 / 306 MVA (SN/SE/WN/WE)
- After Proposed Solution: 251 / 290 / 250 / 306 MVA (SN/SE/WN/WE)

Galion – Hamilton Tap 138 kV Line

- Before Proposed Solution: 195 / 209 / 217 / 229 MVA (SN/SE/WN/WE)
- After Proposed Solution: 200 / 242 / 226 / 286 MVA (SN/SE/WN/WE)

Galion – Marion Ethanol Tap 138 kV Line

- Before Proposed Solution: 160 / 192 / 180 / 228 MVA (SN/SE/WN/WE)
- After Proposed Solution: 160 / 192 / 180 / 228 MVA (SN/SE/WN/WE)

Galion No. 3 345/138 kV Transformer

- Before Proposed Solution: 458 / 478 / 478 / 478 MVA (SN/SLTE/WN/WLTE)
- After Proposed Solution: 606 / 695 / 735 / 828 MVA (SN/SLTE/WN/WLTE)

Galion No. 4 345/138 kV Transformer

- Before Proposed Solution: 400 / 478 / 478 / 478 MVA (SN/SLTE/WN/WLTE)
- After Proposed Solution: 618 / 729 / 743 / 864 MVA (SN/SLTE/WN/WLTE)

**Estimated Project Cost:** \$5.8M

**Projected In-Service:** 08/08/2025

**Supplemental Project ID:** s3360.1

## ATSI Transmission Zone M-3 Process Galion 138 kV Breakers

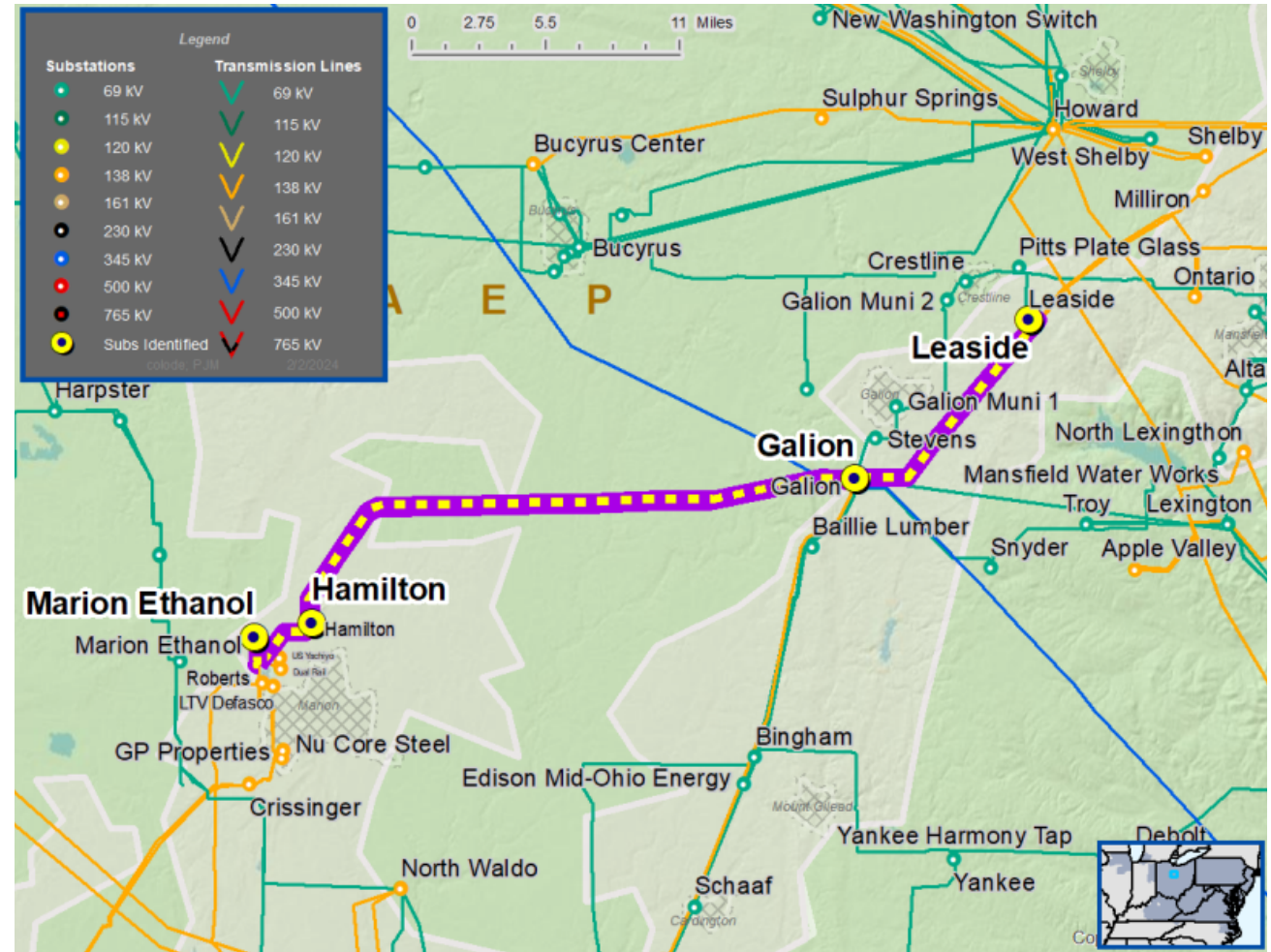



# ATSI Transmission Zone M-3 Process Dowling 138 kV Customer Connection

**Need Number:** ATSI-2023-044  
**Process Stage:** Submission of Supplemental Projects for Inclusion in the Local Plan – 9/10/2024  
**Previously Presented:** Need Meeting – 11/17/2023  
 Solution Meeting – 2/16/2024

**Project Driver(s):**

*Customer Service*

**Specific Assumption Reference(s):**

New customer connection request will be evaluated per FirstEnergy’s “Requirements for Transmission Connected Facilities” document and “Transmission Planning Criteria” document.

**Problem Statement:**

New Customer Connection – A customer has requested a new 138 kV delivery point from the Dowling 138 kV Substation. The anticipated load of the new customer connection is 220 MW

Requested in-service date is 11/30/2025.

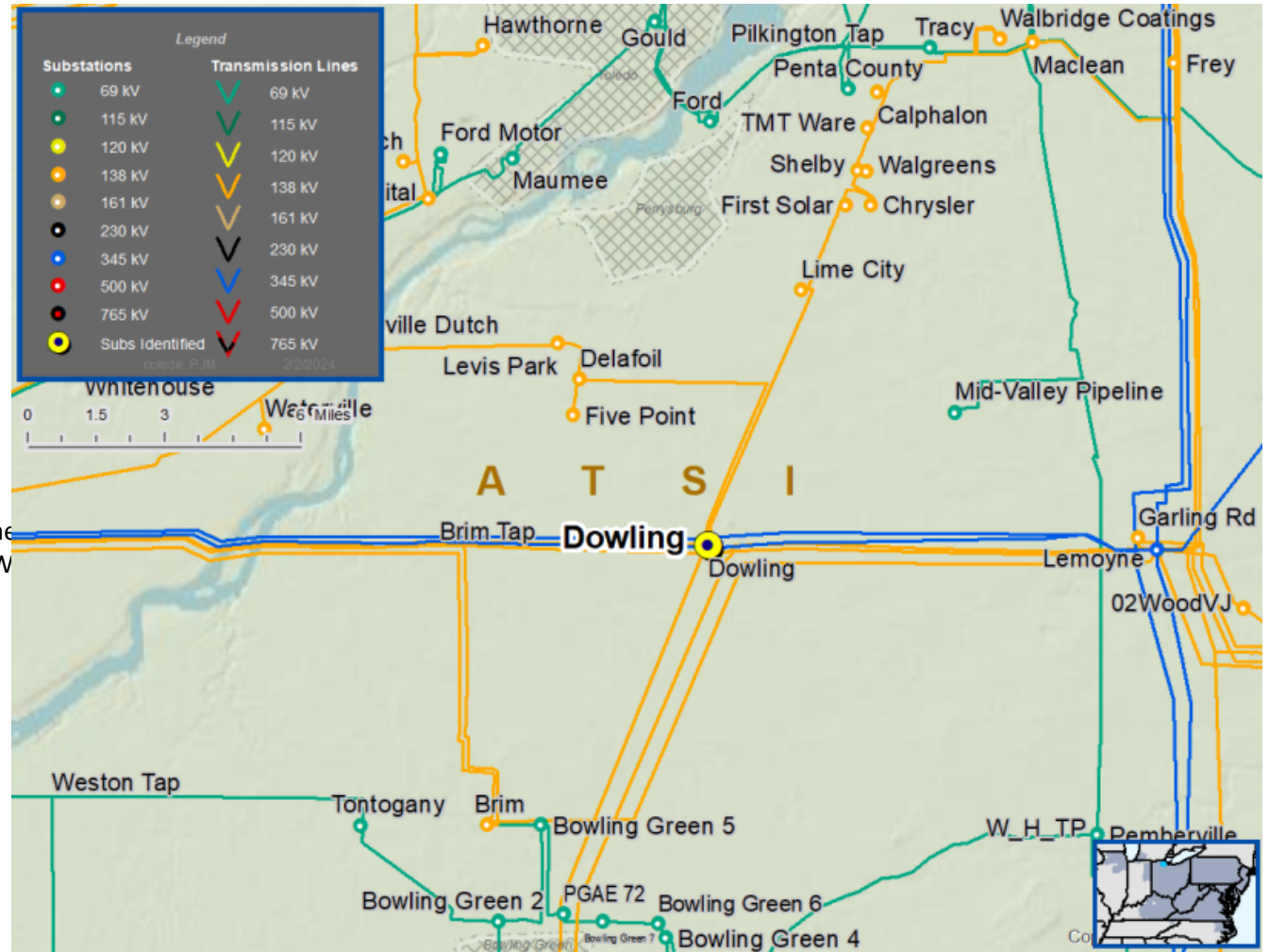



# ATSI Transmission Zone M-3 Process Dowling 138 kV Customer Connection

**Need Number:** ATSI-2023-044  
**Process Stage:** Submission of Supplemental Projects for  
 Inclusion in the Local Plan – 9/10/2024

- Selected Solution:**
- Expand the existing Dowling Substation to a 12-breaker, breaker-and-a-half substation.
  - Build two 138 kV lines, approximately 0.5 miles, from Dowling Substation to the customer substation.

**Estimated Project Costs:** \$10.3M  
**Project In-Service Date:** 11/30/2025  
**Supplemental Project ID:** s3361.1



Legend	
500 kV	
345 kV	
138 kV	
69 kV	
34.5 kV	
23 kV	
New	

**Need Numbers:** ATSI-2024-002

**Process Stage:** Submission of Supplemental Projects for Inclusion in the Local Plan – 9/10/2024

**Previously Presented:** Need Meeting 1/19/2024  
Solutions Meeting – 02/16/2024

**Project Driver:**

*Equipment Condition*

**Specific Assumption Reference:**

Global Considerations

- Past system reliability and performance

Line Condition Rebuild/Replacement

- Transmission Steel Tower, Wood & Steel Poles
- Transmission Line Hardware
- Transmission Line Conductor

**Problem Statement:**

- The Niles Central – Packard 138 kV Line was built in mid 1950s. 42 of the 83 wood pole structures failed inspection due to decay.
- Since 2005, the Niles Central – Packard 138 kV Line has experienced ten outages. Five of the outages were due to failed line equipment and the other five were weather-related. The last five outage have occurred since 2020 including three in 2023.
- The Niles Central – Packard 138 kV Line main section is 8.9 miles long and the tap to Cortland Substation is an additional 3.9 miles.
- A line fault will cause approximately 53 MW of consequential load loss with approximately 16,000 customers at risk.

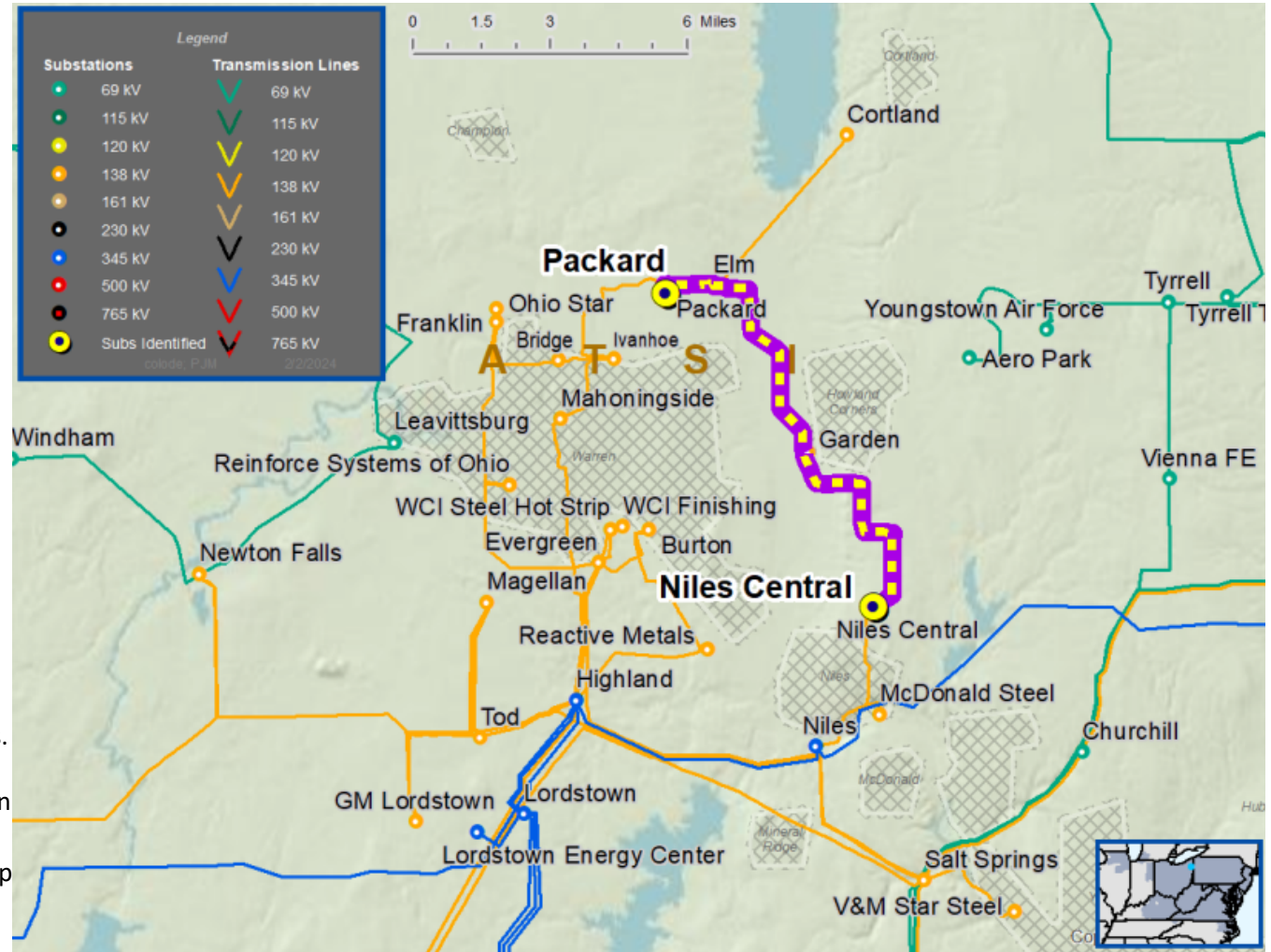



**Need Number:** ATSI-2024-002  
**Process Stage:** Submission of Supplemental Projects for Inclusion in the Local Plan – 9/10/2024

**Selected Solution:**

Niles Central – Packard 138 kV Line Rebuild

- Rebuild the Niles Central – Packard 138 kV Line with new conductor, approximately 8.9 miles.

**Transmission Line Ratings:**

Packard – Elm 138 kV Line

- Before Proposed Solution: 157 / 196 / 198 / 255 MVA (SN/SE/WN/WE)
- After Proposed Solution: 221 / 268 / 250 / 317 MVA (SN/SE/WN/WE)

Elm – Garden 138 kV Line

- Before Proposed Solution: 157 / 196 / 198 / 255 MVA (SN/SE/WN/WE)
- After Proposed Solution: 221 / 268 / 250 / 317 MVA (SN/SE/WN/WE)

Garden – Niles Central 138 kV Line

- Before Proposed Solution: 157 / 196 / 198 / 255 MVA (SN/SE/WN/WE)
- After Proposed Solution: 221 / 268 / 250 / 317 MVA (SN/SE/WN/WE)

**Estimated Project Cost:** \$12.6M  
**Projected In-Service:** 12/31/2025  
**Supplemental Project ID:** s3362.1

## ATSI Transmission Zone M-3 Process Niles Central – Packard 138 kV Line

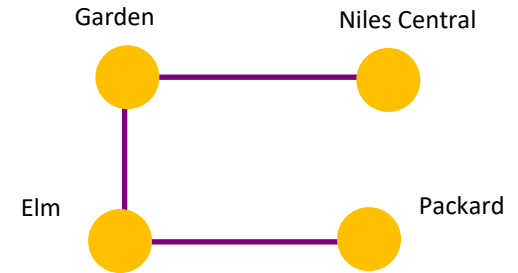

Legend	
500 kV	
345 kV	
138 kV	
69 kV	
34.5 kV	
23 kV	
New	

**Need Numbers:** ATSI-2024-004

**Process Stage:** Submission of Supplemental Projects for Inclusion in the Local Plan – 9/10/2024

**Previously Presented:** Need Meeting 01/19/2024  
Solution Meeting 03/15/2024

**Project Driver:**

*Equipment Material Condition, Performance and Risk*

**Specific Assumption Reference:**

System Performance Projects Global Factors

- System reliability and performance
- Substation/line equipment limits

System Condition Projects

- Substation Condition Rebuild/Replacement

Upgrade Relay Schemes

- Obsolete and difficult to repair communication equipment (DTT, Blocking, etc.)
- Communication technology upgrades

**Problem Statement:**

- FirstEnergy has identified protection schemes using a certain vintage of relays and communication equipment that have a history of misoperation.
- Proper operation of the protection scheme requires all the separate components perform adequately during a fault.
- In many cases the protection equipment cannot be repaired due to a lack of replacement parts and available expertise in the outdated technology.
- Transmission line ratings are limited by terminal equipment.

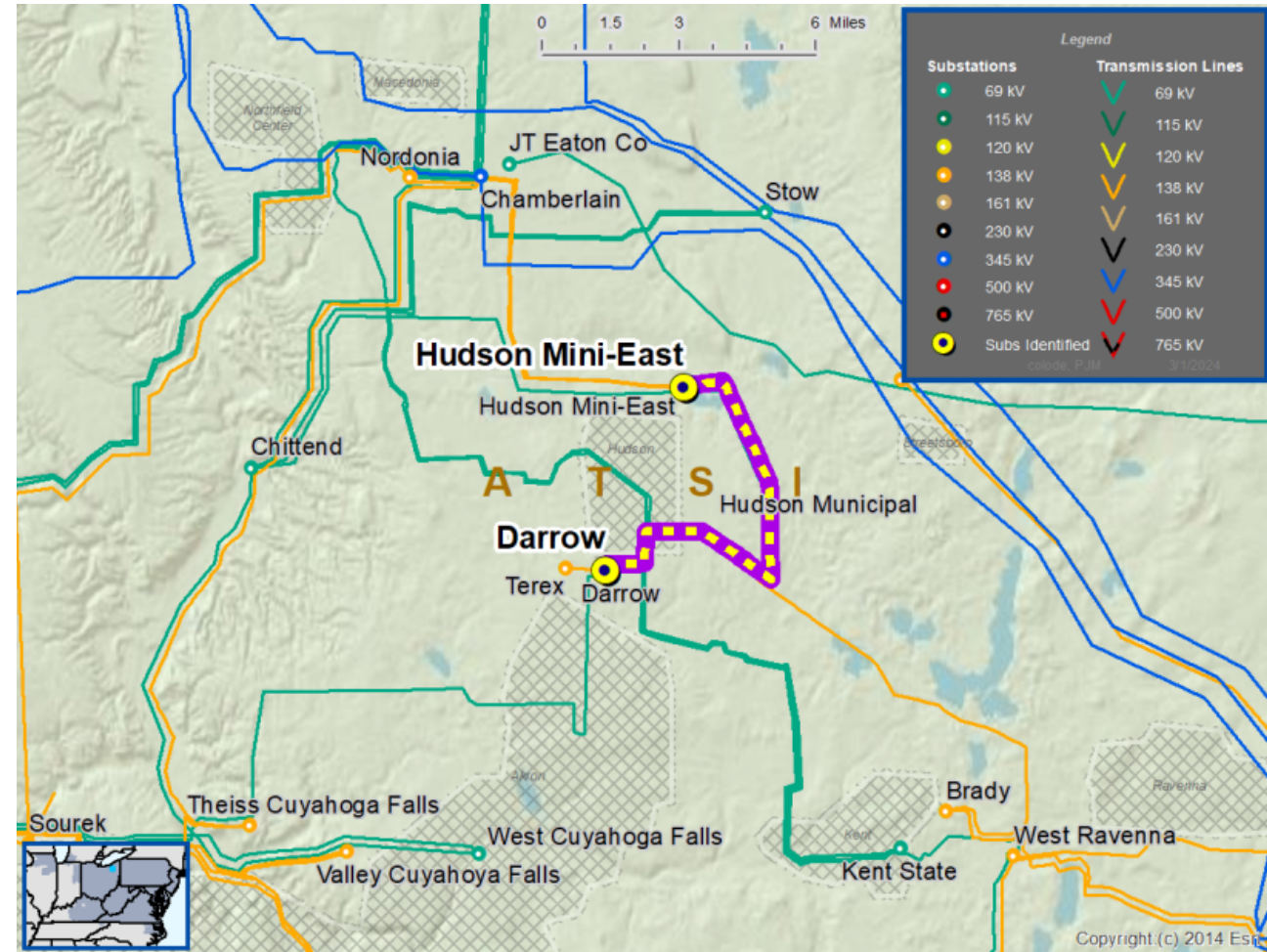





# ATSI Transmission Zone M-3 Process Darrow – Hudson East 138 kV Misoperation Relays

Need #	Transmission Line / Substation Locations	Existing Line Rating (SN / SE / WN / WE)	Existing Conductor Rating (SN / SE / WN / WE)
ATSI-2024-004	Darrow – Hudson East 138 kV Line	191 / 191 / 191 / 191	200 / 242 / 226 / 286



# ATSI Transmission Zone M-3 Process Darrow – Hudson East 138 kV Misoperation Relays

**Need Number:** ATSI-2024-004  
**Process Stage:** Submission of Supplemental Projects for Inclusion in the Local Plan – 9/10/2024

**Selected Solution:**

- Replace limiting substation conductor, line trap, and relaying at Hudson East Substation

**Transmission Line Ratings:**

Darrow – Hudson East 138 kV Line

- Before Proposed Solution: 191 / 191 / 191 / 191 MVA (SN/SE/WN/WE)
- After Proposed Solution: 200 / 242 / 226 / 286 MVA (SN/SE/WN/WE)

**Estimated Project Cost:** \$ 1.9 M  
**Projected In-Service:** 5/15/2026  
**Supplemental Project ID:** s3373.1



Legend	
500 kV	
345 kV	
230 kV	
138 kV	
115 kV	
69 kV	
46 kV	
34.5 kV	
23 kV	
New	

**Need Number:** ATSI-2024-005  
**Process Stage:** Submission of Supplemental Projects for Inclusion in the Local Plan – 9/10/2024  
**Previously Presented:** Need Meeting – 1/19/2024  
 Solution Meeting – 2/16/2024

**Supplemental Project Driver(s):**  
*Customer Service*

**Specific Assumption Reference(s):**  
 New customer connection request will be evaluated per FirstEnergy’s “Requirements for Transmission Connected Facilities” document and “Transmission Planning Criteria” document.

**Problem Statement**  
 Customer Connection – A customer has requested a new 69 kV delivery point from the Abbe – Medina 69 kV Line. The Customer is separating from a shared revenue metering point and is requesting a new delivery point along the same transmission line. The load of the customer connection is 3.1 MVA.

**Requested In-Service Date:**  
 December 1, 2021

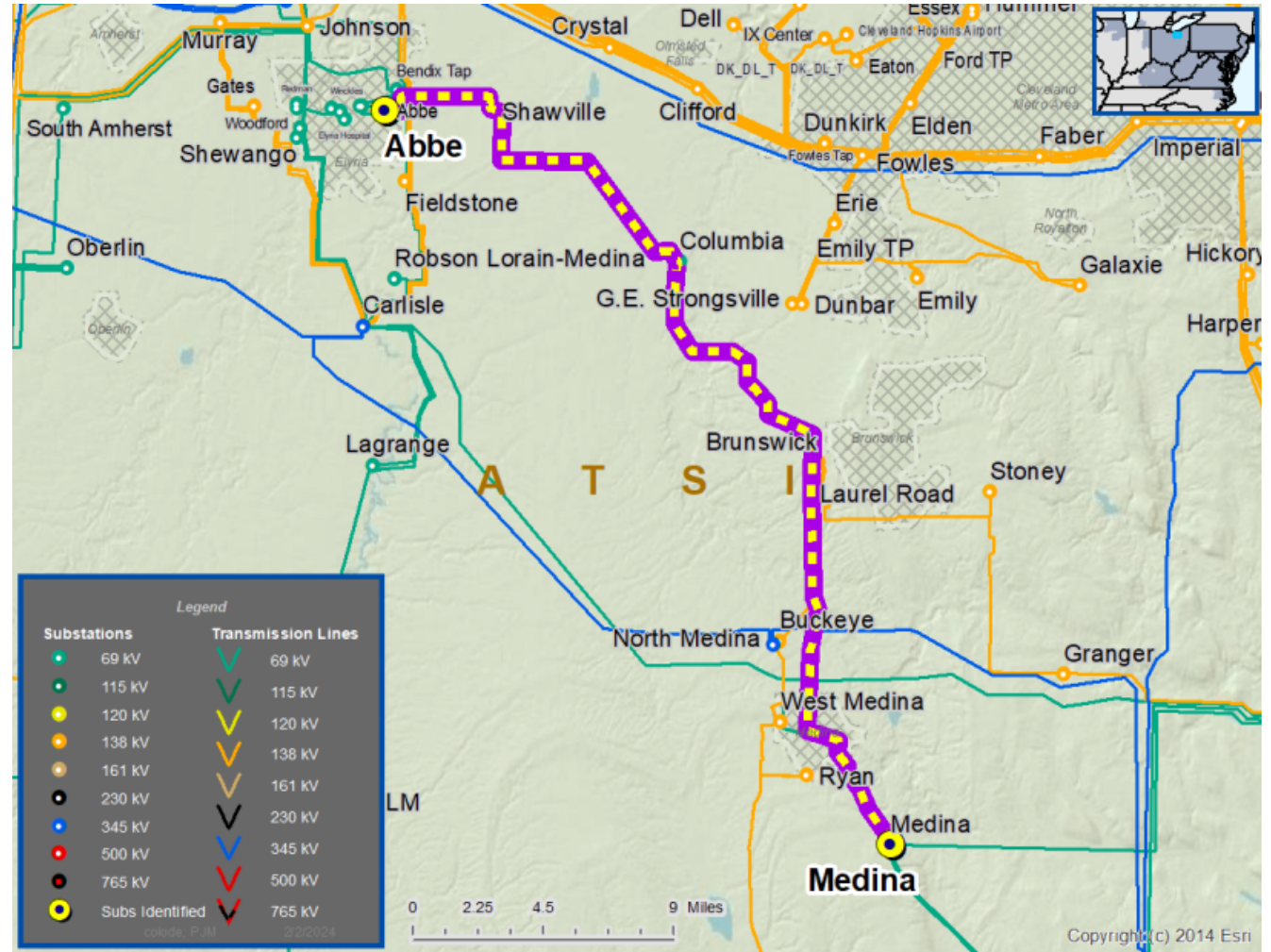



# ATSI Transmission Zone M-3 Process Abbe – Medina 69 kV Line Customer Connection

**Need Number:** ATSI-2024-005  
**Process Stage:** Submission of Supplemental Projects for Inclusion in the Local Plan – 9/10/2024

- Selected Solution:**
- Install one SCADA controlled transmission line switch on existing tap from the Abbe – Medina 69 kV Line.
  - Construct approximately 100 ft of transmission line from tap point to the customer substation.

**Estimated Project Costs:** \$0.0M  
**Project In-Service Date:** 6/1/2024  
**Supplemental Project ID:** s3363.1

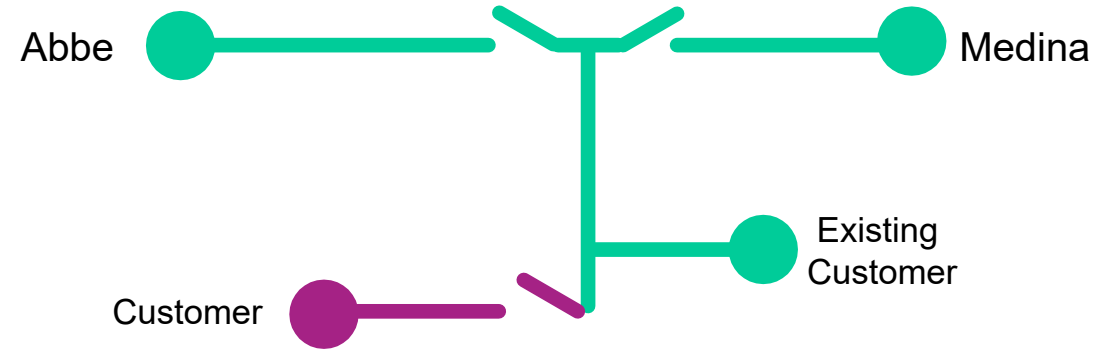

Legend	
500 kV	
345 kV	
138 kV	
69 kV	
34.5 kV	
23 kV	
New	



# ATSI Transmission Zone M-3 Process Maysville – McDowell 69 kV Line

**Need Number:** ATSI-2020-031  
**Process Stage:** Submission of Supplemental Projects for Inclusion in the Local Plan – 9/24/2024  
**Previously Presented:** Need Meeting – 08/14/2020  
Solutions Meeting – 06/14/2024

**Supplemental Project Driver(s):**

*Equipment Material Condition, Performance and Risk*

**Specific Assumption Reference(s)**

**Line Condition Rebuild / Replacement**

- Aged or deteriorated transmission line structures
- Negatively impact customer outage frequency and/or durations
- Demonstrate an increasing trend in maintenance findings and/or costs

**Problem Statement:**

Maysville-McDowell 69kV Line (~33 miles):

- Line was originally constructed in the 1960s. The average age of structures on this line are 54 years old. FirstEnergy has historically experienced an average age of reject for wood poles to be 48.7 years.
- Line survey in 2019 showed a structure reject rate of 86% (528 of 613). The primary reasons for reject were woodpecker holes, wood pole decay, and pole top extensions previously used to mitigate the issue of pole top rot, an indicator that the pole is deteriorating.
- Conductor condition is deteriorating with over 40 conductor splices in a 30-mile line section.
- Terminal end equipment at McDowell should be upgraded due to age and condition.
- Obsolete line switches (A-2092, A-2091, A-2143 N.O.) are no longer supported by the manufacturer.

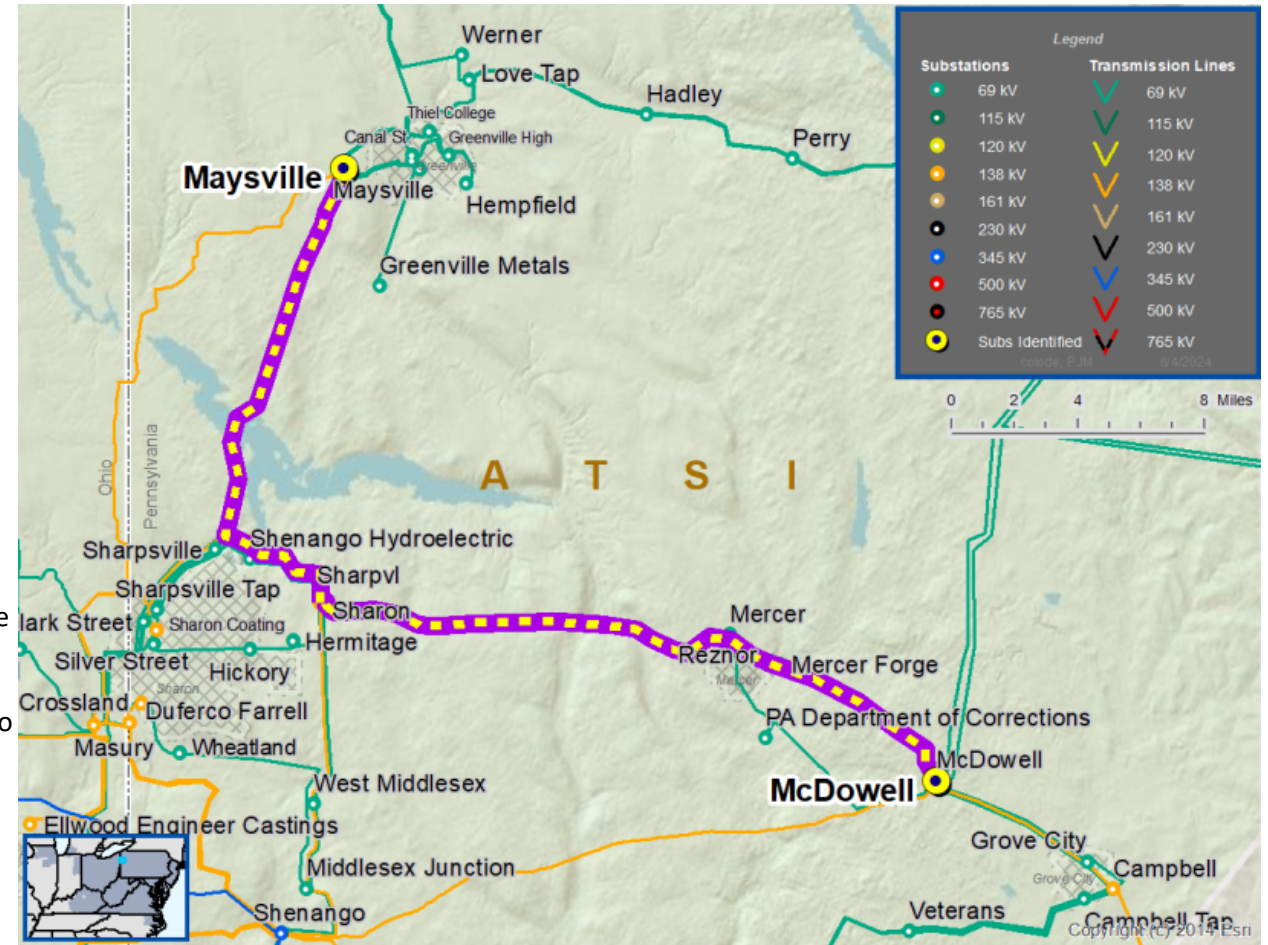



# ATSI Transmission Zone M-3 Process Maysville – McDowell 69 kV Line

**Need Number:** ATSI-2020-031  
**Process Stage:** Submission of Supplemental Projects for Inclusion in the Local Plan – 9/24/2024

**Selected Solution:**

Maysville-McDowell 69 kV Line Rebuild

- Rebuild the Maysville-McDowell 69 kV Line, excluding the line section from Werner Substation to Hartstown Substation (total rebuild length approximately 35 miles).
- Replace three obsolete line switches.
- Replace the 69 kV circuit breaker B26 and associated disconnect switches at McDowell Substation.
- Replace the substation conductor at Greenville Substation.
- Upgrade line relaying at McDowell Substation.
- Update relay settings at Maysville Substation.

**Transmission Line Ratings:**

- **Maysville – Greenville 69 kV Line**
  - Before Proposed Solution: 62 / 77 / 78 / 101 MVA (SN/SE/WN/WE)
  - After Proposed Solution: 80 / 96 / 90 / 114 MVA (SN/SE/WN/WE)
- **Greenville – Hempfield 69 kV Line**
  - Before Proposed Solution: 37 / 46 / 47 / 61 MVA (SN/SE/WN/WE)
  - After Proposed Solution: 80 / 96 / 90 / 114 MVA (SN/SE/WN/WE)
- **Hempfield – Werner 69 kV Line**
  - Before Proposed Solution: 37 / 46 / 47 / 61 MVA (SN/SE/WN/WE)
  - After Proposed Solution: 80 / 96 / 90 / 114 MVA (SN/SE/WN/WE)
- **Werner – Hadley 69 kV Line**
  - Before Proposed Solution: 62 / 77 / 78 / 101 MVA (SN/SE/WN/WE)
  - After Proposed Solution: 80 / 96 / 90 / 114 MVA (SN/SE/WN/WE)
- **Hadley – Perry 69 kV Line**
  - Before Proposed Solution: 62 / 77 / 78 / 101 MVA (SN/SE/WN/WE)
  - After Proposed Solution: 80 / 96 / 90 / 114 MVA (SN/SE/WN/WE)

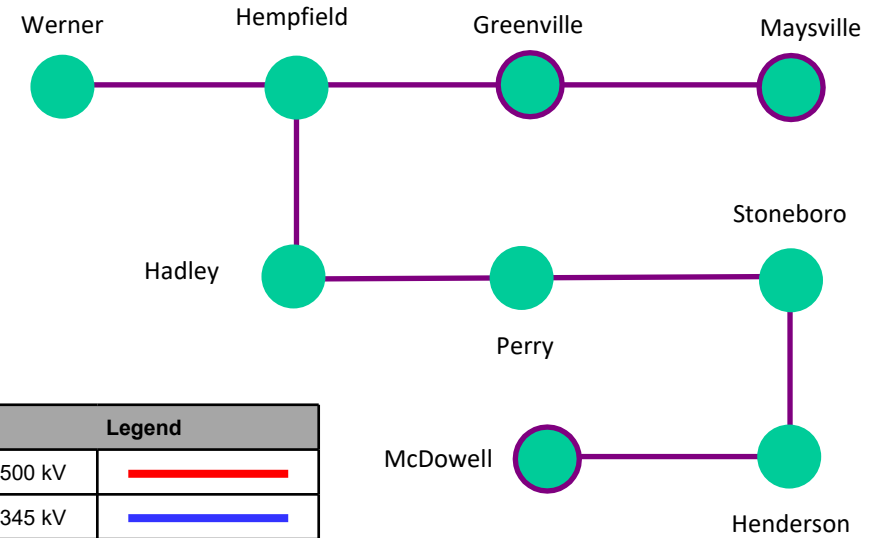

Legend	
500 kV	
345 kV	
138 kV	
69 kV	
34.5 kV	
23 kV	
New	



# ATSI Transmission Zone M-3 Process Maysville – McDowell 69 kV Line

**Need Number:** ATSI-2020-031  
**Process Stage:** Submission of Supplemental Projects for Inclusion in the Local Plan – 9/24/2024

**Transmission Line Ratings Continued:**

- **Perry – Stoneboro 69 kV Line**
  - Before Proposed Solution: 62 / 77 / 78 / 101 MVA (SN/SE/WN/WE)
  - After Proposed Solution: 80 / 96 / 90 / 114 MVA (SN/SE/WN/WE)
- **Stoneboro – Henderson 69 kV Line**
  - Before Proposed Solution: 47 / 56 / 53 / 67 MVA (SN/SE/WN/WE)
  - After Proposed Solution: 80 / 96 / 90 / 114 MVA (SN/SE/WN/WE)
- **Henderson – McDowell 69 kV Line**
  - Before Proposed Solution: 47 / 56 / 53 / 67 MVA (SN/SE/WN/WE)
  - After Proposed Solution: 80 / 96 / 90 / 114 MVA (SN/SE/WN/WE)

**Estimated Project Cost:** \$55.3 M  
**Projected In-Service:** 7/25/2028  
**Supplemental Project ID:** s3494.1

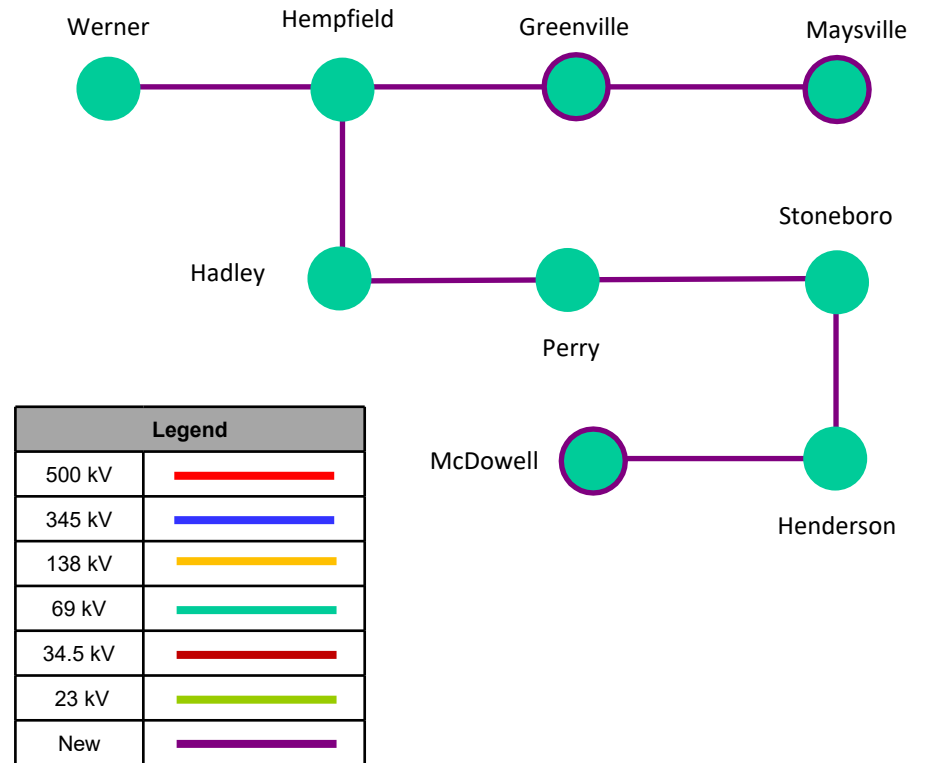

**Need Number:** ATSI-2022-001  
**Process Stage:** Submission of Supplemental Projects for Inclusion in the Local Plan - 9/24/2024  
**Previously Presented:** Need Meeting – 02/18/2022  
 Solution Meeting – 06/14/2024

**Supplemental Project Driver(s):**  
*Equipment Material Condition, Performance and Risk*

**Specific Assumption Reference(s):**

**Line Condition Rebuild / Replacement**

- Aged or deteriorated wood pole transmission line structures
- Negatively impact customer outage frequency and/or durations
- Demonstrate an increasing trend in maintenance findings and/or costs
- Transmission line ratings are limited by terminal equipment

**Problem Statement:**

Cascade 69 kV (~18.3 miles) Line:

- The average age of structures on this line are 55 years old.
- The Cascade (Cedar Street) 69 kV line is exhibiting an upward trend in both minor and major maintenance required with 108 open priority conditions.
- Recent inspections show a structure reject rate of 38% (117 of 307). The primary reasons for reject were cracked and deteriorated wood poles, woodpecker holes, and failed insulators.
- 3 out of the 11 line switches on the Cascade (Cedar Street) 69 kV line are obsolete and no longer meet established design standards.
- The Cascade (Cedar Street) 69 kV line has experienced 14 unscheduled outages in the past five years (5 sustained).

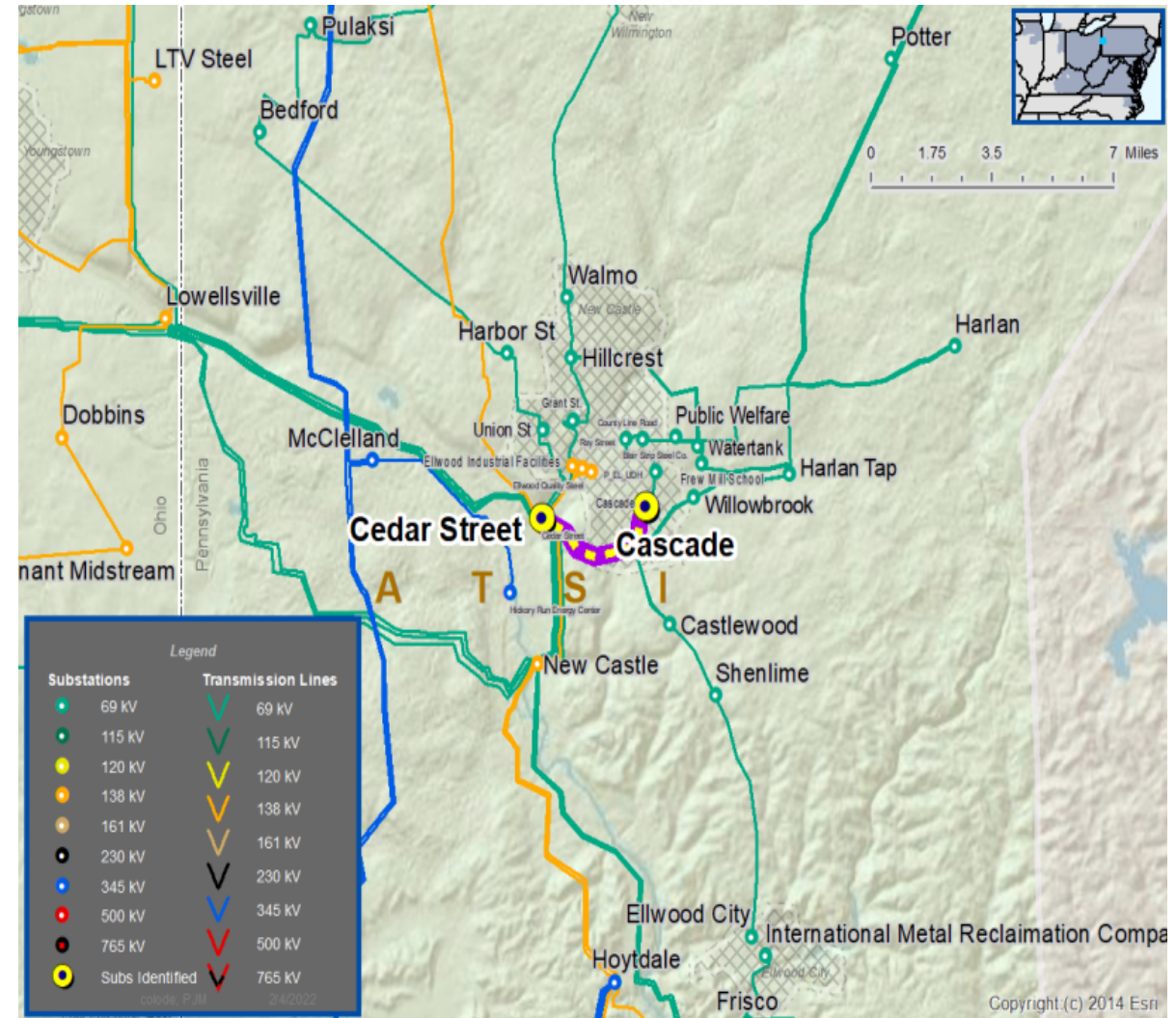





**Need Number:**

ATSI-2022-001

**Process Stage:**

Submission of Supplemental Projects for Inclusion in the Local Plan - 9/24/2024

**Selected Solution:**

**Cascade (Cedar Street) 69 kV Line**

- Reconductor the Cascade (Cedar Street) 69 kV Line, approximately 18.3 miles.

**Transmission Line Ratings:**

▪ **Cedar St – Cascade 69kV Line**

- Before Proposed Solution: 80 / 96 / 90 / 114 MVA (SN/SE/WN/WE)
- After Proposed Solution: 80 / 96 / 90 / 114 MVA (SN/SE/WN/WE)

▪ **Blair Strip Steel – Cascade 69kV Line**

- Before Proposed Solution: 80 / 96 / 90 / 114 MVA (SN/SE/WN/WE)
- After Proposed Solution: 80 / 96 / 90 / 114 MVA (SN/SE/WN/WE)

▪ **Blair Strip Steel – Ray St 69kV Line**

- Before Proposed Solution: 80 / 96 / 90 / 114 MVA (SN/SE/WN/WE)
- After Proposed Solution: 80 / 96 / 90 / 114 MVA (SN/SE/WN/WE)

▪ **Ray St – YDC- West Tap 69kV Line**

- Before Proposed Solution: 80 / 96 / 90 / 114 MVA (SN/SE/WN/WE)
- After Proposed Solution: 80 / 96 / 90 / 114 MVA (SN/SE/WN/WE)

▪ **Public Welfare – YDC- West Tap 69kV Line**

- Before Proposed Solution: 47 / 56 / 53 / 67 MVA (SN/SE/WN/WE)
- After Proposed Solution: 80 / 96 / 90 / 114 MVA (SN/SE/WN/WE)

▪ **Hillcrest – YDC- West Tap 69kV Line**

- Before Proposed Solution: 80 / 96 / 90 / 114 MVA (SN/SE/WN/WE)
- After Proposed Solution: 80 / 96 / 90 / 114 MVA (SN/SE/WN/WE)

## ATSI Transmission Zone M-3 Process Cascade (Cedar Street) 69 kV Line

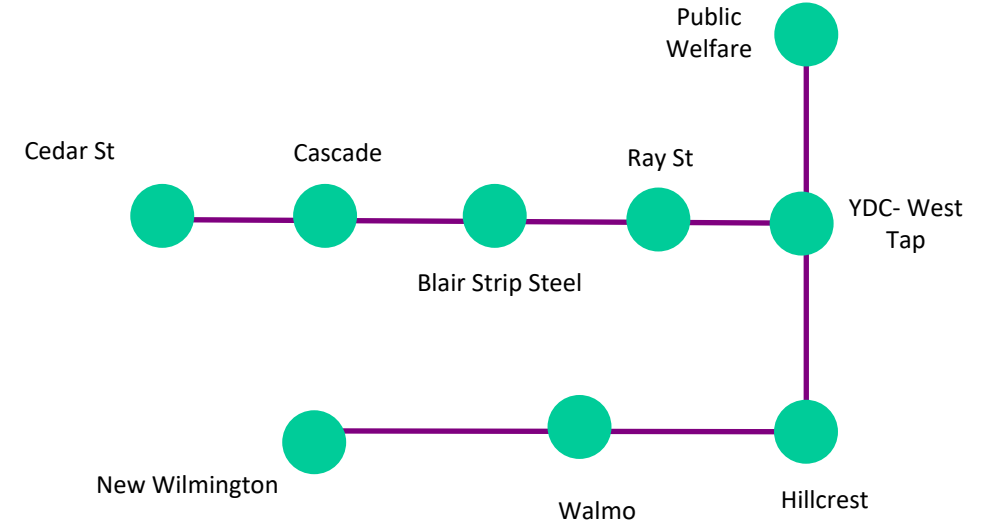

Legend	
500 kV	
345 kV	
138 kV	
69 kV	
34.5 kV	
23 kV	
New	



**Need Number:** ATSI-2022-001  
**Process Stage:** Submission of Supplemental Projects for Inclusion in the Local Plan - 9/24/2024

**Transmission Line Ratings:**

- **Hillcrest – Walmo 69kV Line**
  - Before Proposed Solution: 80 / 96 / 90 / 114 MVA (SN/SE/WN/WE)
  - After Proposed Solution: 80 / 96 / 90 / 114 MVA (SN/SE/WN/WE)
- **New Wilmington – Walmo 69kV Line**
  - Before Proposed Solution: 47 / 48 / 53 / 53 MVA (SN/SE/WN/WE)
  - After Proposed Solution: 80 / 96 / 90 / 114 MVA (SN/SE/WN/WE)

**Estimated Project Cost:** \$34.7 M  
**Projected In-Service:** 3/31/2028  
**Supplemental Project ID:** s3495.1

## ATSI Transmission Zone M-3 Process Cascade (Cedar Street) 69 kV Line

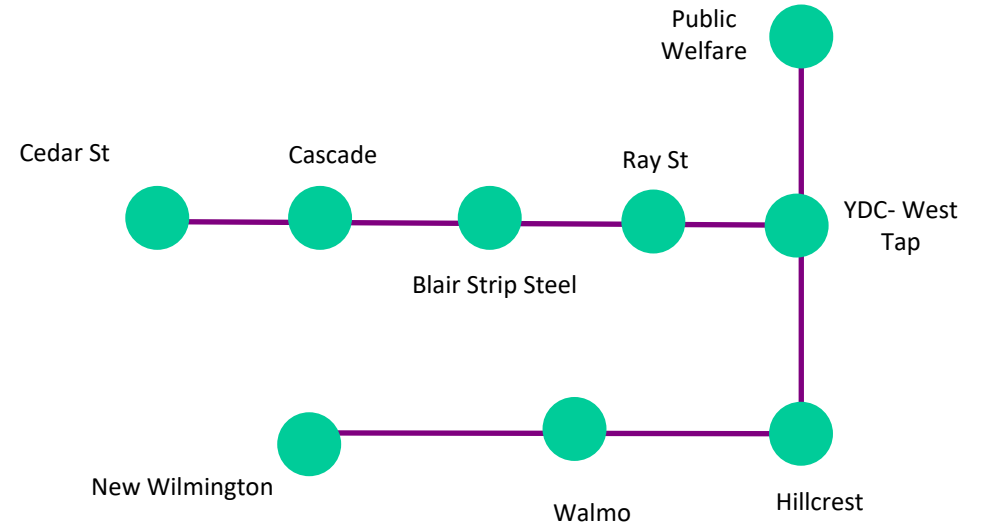

Legend	
500 kV	
345 kV	
138 kV	
69 kV	
34.5 kV	
23 kV	
New	



# ATSI Transmission Zone M-3 Process West Unity (Stryker) 69 kV Line

**Need Number:** ATSI-2022-006  
**Process Stage:** Submission of Supplemental Projects for Inclusion in the Local Plan – 9/24/2024  
**Previously Presented:** Need Meeting – 03/18/2022  
Solutions Meeting – 06/14/2024

**Supplemental Project Driver(s):**  
*Equipment Material Condition, Performance, and Risk  
Infrastructure Resilience*

**Specific Assumption Reference(s):**  
System Performance Projects Global Factors

- System Reliability and Performance
- Increasing negative trend in maintenance findings
- Age/condition of transmission line conductor, hardware and structures
- Negatively impact customer outage frequency and/or duration

**Problem Statement**

- The West Unity (Stryker) 69 kV Line (~11.2 miles) is wood pole construction that is aged and experiencing degradation:
  - 53 of 258 structures had defects noted that could negatively impact reliability, with the most common defect noted being structure decay.
  - 235 of 258 structures are aged and reaching the end of their useful life, with average date of installation of 1967.
- A stretch of double circuit structures were replaced in the 1990's (~1.5 miles) and found to be in fair condition.

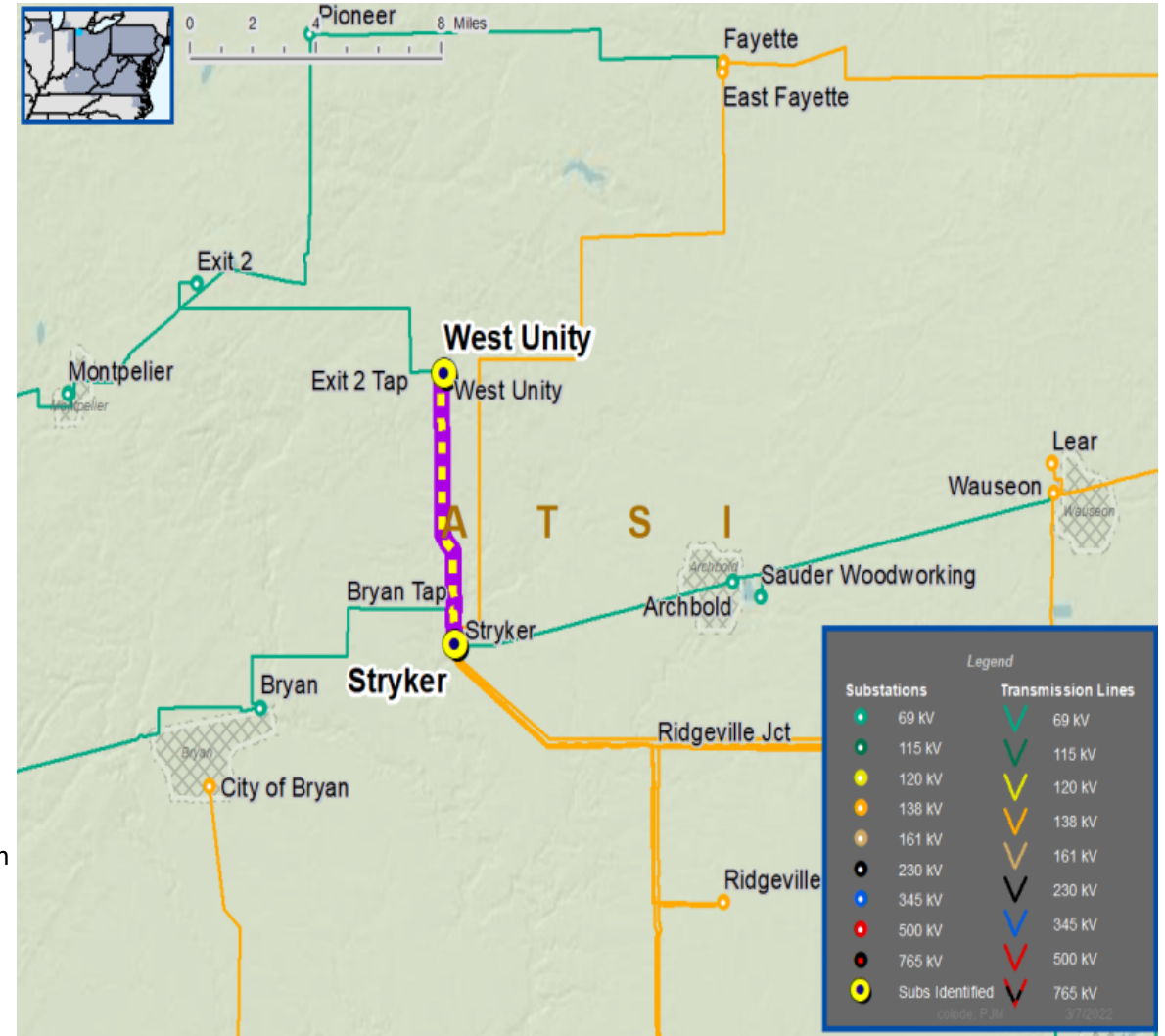



# ATSI Transmission Zone M-3 Process West Unity (Stryker) 69 kV Line

**Need Number:** ATSI-2022-006  
**Process Stage:** Submission of Supplemental Projects for Inclusion in the Local Plan – 9/24/2024

**Selected Solution:**

West Unity (Stryker) 69 kV Line Rebuild  
 ▪ Rebuild the West Unity (Stryker) 69 kV Line (total rebuild length approximately 11.6 miles).

**Transmission Line Ratings:**

- **Snyder – West Unity 69 kV Line**
  - Before Proposed Solution: 72 / 87 / 84 / 107 MVA (SN/SE/WN/WE)
  - After Proposed Solution: 111 / 135 / 126 / 159 MVA (SN/SE/WN/WE)

**Stryker – West Unity 69 kV Line**

- Before Proposed Solution: 72 / 87 / 84 / 107 MVA (SN/SE/WN/WE)
- After Proposed Solution: 111 / 135 / 126 / 159 MVA (SN/SE/WN/WE)

**Estimated Project Cost:** \$18.1M  
**Projected In-Service:** 12/31/2025  
**Supplemental Project ID:** s3496.1

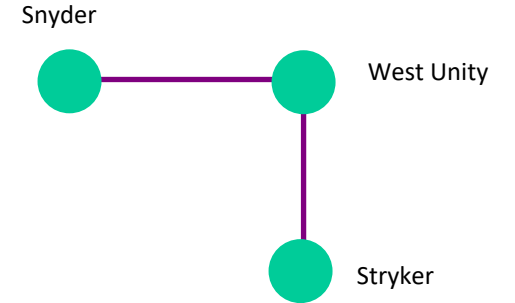

Legend	
500 kV	
345 kV	
138 kV	
69 kV	
34.5 kV	
23 kV	
New	

**Need Number:** ATSI-2022-012  
**Process Stage:** Submission of Supplemental Projects for Inclusion in the Local Plan - 9/24/2024  
**Previously Presented:** Need Meeting – 05/19/2022  
 Solution Meeting – 6/14/2024

**Supplemental Project Driver(s):**  
*FE's Requirement for Transmission Connected Facilities*  
*Operational Flexibility and Efficiency*  
*Equipment Material Condition, Performance and Risk*  
*Infrastructure Resilience*  
*Customer Service*

**Specific Assumption Reference(s):**  
**System Performance Projects Global Factors**

- System reliability and performance
- Substation/Line equipment limits
- Customer Service

**Equipment/Technology/Design upgrades**

- FirstEnergy-owned equipment located in non-FirstEnergy affiliated facilities.
- Expected service life (at or beyond) or obsolescence

**Add/Replace Transformer**

- System concerns related to loss of an existing transformer or other contingency scenarios at a specific voltage level(s)



**Need Number:** ATSI-2022-012  
**Process Stage:** Submission of Supplemental Projects for Inclusion in the Local Plan - 9/24/2024

### Problem Statement

- West Lorain plant was previously owned by FE. With the sale of the plant, FE must separate assets owned by FE from assets owned by the new plant owners.
- Station power for West Lorain is sourced from the tertiary windings of the two 345-138-13.2 kV transformers at Beaver Substation.
- The two 345-138-13.2 kV transformers at Beaver are reaching end of life and will be replaced with transformers Refer to supplemental ID s1757.
- 138 kV circuit breaker B-23 is owned by FE. The breaker and breaker controls are located within the West Lorain plant property.
- 345 kV motor operated disconnect switch D-177 is owned by West Lorain but is inside FE's Beaver Substation.
- Relays that protect the 138 kV line from Beaver to West Lorain are owned by FE but are located within the West Lorain property.
- The 345 kV line and the 138 kV line to the West Lorain plant are protected by older electromechanical relays that require additional maintenance and skill to maintain.

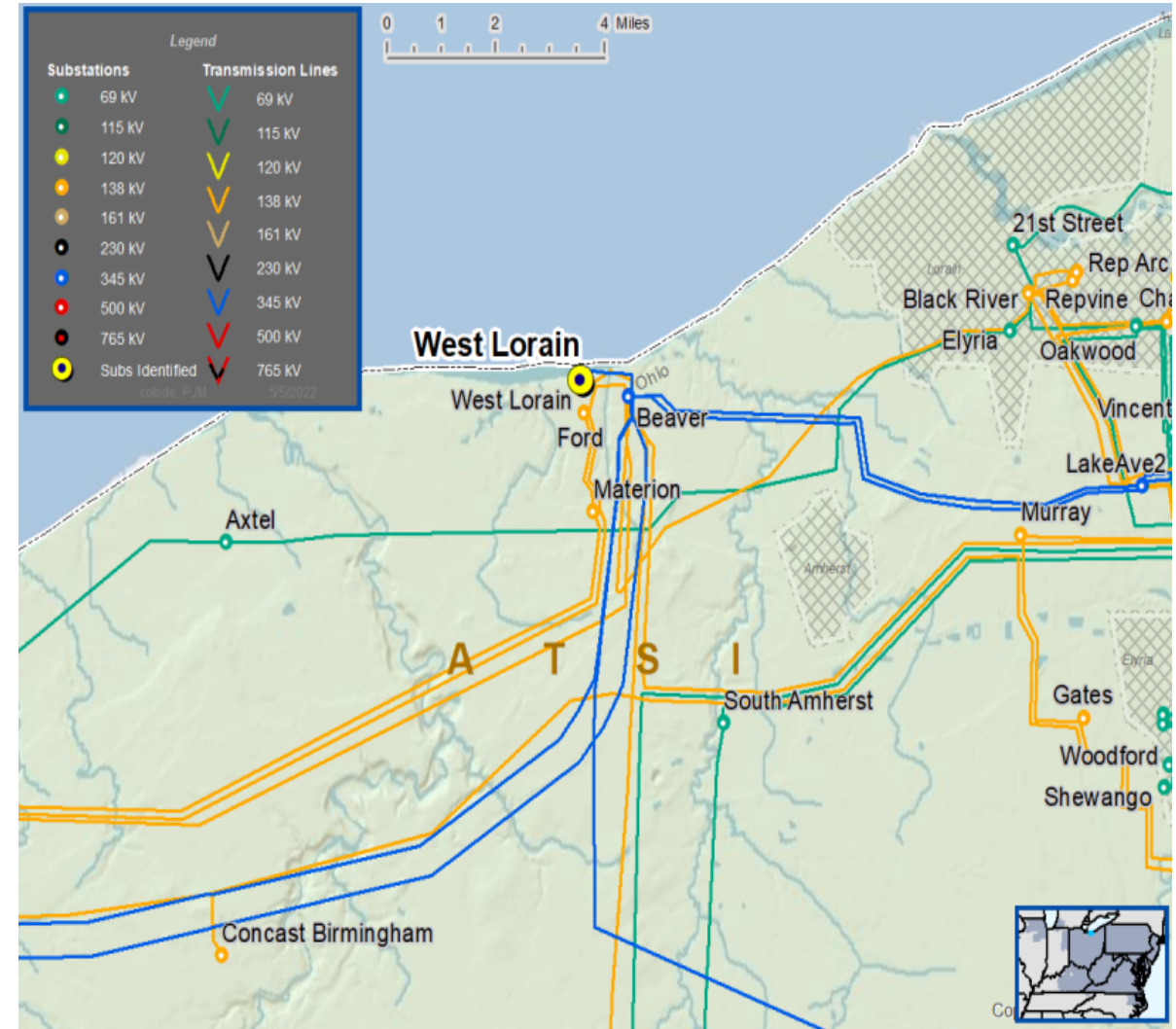



**Need Number:** ATSI-2022-012  
**Process Stage:** Submission of Supplemental Projects for Inclusion in the Local Plan - 9/24/2024

**Selected Solution:**

- Install 138 kV tie line breaker and associated relaying at West Lorain
- Install revenue metering equipment on the 138 kV tie line at Beaver
- Remove breaker B-23 and associated relaying
- Upgrade revenue metering equipment for West Lorain units 2-6.
- Transfer ownership of the 345 kV motor operated disconnect switch D-177 at Beaver Substation to ATSI

**Estimated Project Costs:** \$3.56M  
**Project In-Service Date:** 12/1/2025  
**Supplemental Project ID:** s3497.1

## ATSI Transmission Zone M-3 Process West Lorain Plant Separation



Legend	
500 kV	
345 kV	
138 kV	
69 kV	
34.5 kV	
23 kV	
New	

**Need Number:** ATSI-2022-027

**Process Stage:** Submission of Supplemental Projects for Inclusion in the Local Plan – 9/24/2024

**Previously Presented:** Need Meeting– 10/14/2022  
Solutions Meeting – 05/17/2024

**Supplemental Project Driver(s):**  
*Equipment Material Condition, Performance and Risk  
Infrastructure Resilience*

**Specific Assumption Reference(s):**

Global Factors

- Aged or deteriorated wood pole transmission line structures
- Negatively impact customer outage frequency and/or durations
- Demonstrate an increasing trend in maintenance findings and/or costs
- Transmission line ratings are limited by terminal equipment.

**Problem Statement**

- The Milton – Newton Falls 69 kV Line is approximately 27.3 miles in length:
- Assessment found 70 of 343 wood poles had defects that could negatively affect reliability. Defects included decay, top rot and multiple woodpecker holes.
  - 313 wood poles nearing end of life; Original poles date 1970 (50+ years at construction).
  - 23 maintenance records including 13 pole replacements in last 5 years indicating upward trend in maintenance.
  - There are four delivery points with approximately 6,538 customers and 44.65 MVA of load served.
  - Since 2017, the Milton – Newton Falls 69 kV Line had six momentary and five sustained outages.







**Need Number:** ATSI-2022-027  
**Process Stage:** Submission of Supplemental Projects for Inclusion in the Local Plan – 9/24/2024

**Selected Solution:**

Milton – Newton Falls 69 kV Line Rebuild

- Rebuild approximately 27.3 miles of Milton – Newton Falls 69 kV Line
- Replace line relaying at Milton Substation on the Newton Falls terminal

**Transmission Line Ratings:**

- **Newton Falls – Newton Falls Muni 69 kV Line**
  - Before Proposed Solution: 45 MVA SN / 48 MVA SE / 48 MVA WN / 48 MVA WE
  - After Proposed Solution: 80 MVA SN / 96 MVA SE / 90 MVA WN / 114 MVA WE
- **Newton Falls Muni – Milton Lake 69 kV Line**
  - Before Proposed Solution: 45 MVA SN / 54 MVA SE / 51 MVA WN / 65 MVA WE
  - After Proposed Solution: 80 MVA SN / 96 MVA SE / 90 MVA WN / 114 MVA WE
- **Berlin Dam – Milton Lake 69 kV Line**
  - Before Proposed Solution: 45 MVA SN / 54 MVA SE / 51 MVA WN / 65 MVA WE
  - After Proposed Solution: 80 MVA SN / 96 MVA SE / 90 MVA WN / 114 MVA WE
- **Berlin Dam – Berlin Center 69 kV Line**
  - Before Proposed Solution: 45 MVA SN / 54 MVA SE / 51 MVA WN / 65 MVA WE
  - After Proposed Solution: 80 MVA SN / 96 MVA SE / 90 MVA WN / 114 MVA WE

**Estimated Project Cost:** \$45.92 M  
**Projected In-Service:** 12/29/2028  
**Supplemental Project ID:** s3467.1

## ATSI Transmission Zone M-3 Process Milton – Newton Falls 69 kV Line

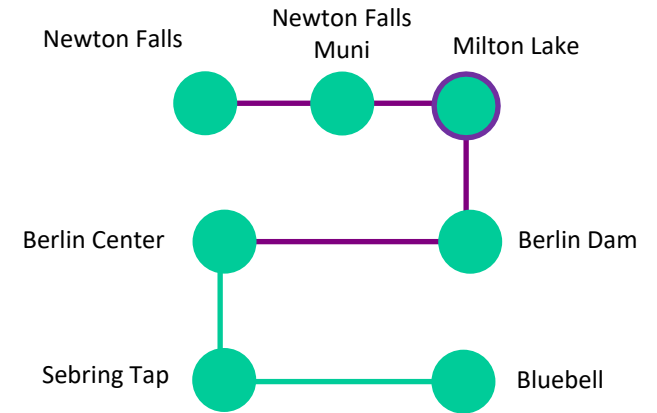

Legend	
500 kV	
345 kV	
138 kV	
69 kV	
34.5 kV	
23 kV	
New	

**Need Number:** ATSI-2023-012

**Process Stage:** Submission of Supplemental Projects for Inclusion in the Local Plan – 9/24/2024

**Previously Presented:** Need Meeting – 6/16/2023  
Solution Meeting – 6/14/2024

**Supplemental Project Driver(s):**  
*Operational Flexibility and Efficiency*  
*Equipment Material Condition, Performance and Risk*  
*Infrastructure Resilience*

- Specific Assumption Reference(s):**
- System Performance Projects Global Factors
- System reliability and performance
  - Load at risk in planning and operational scenarios
- Add/Expand Bus Configuration
- Loss of substation bus adversely impacts transmission system performance
  - Eliminate simultaneous outages to multiple networked elements under N-1 analysis
  - Accommodate future transmission facilities
  - Capability to perform system maintenance

- Problem Statement:**
- The Cloverdale – Dale No. 2 69 kV Line is 14.74 miles and serves seven delivery points.
  - A line fault will cause approximately 82 MW consequential loss of load and approximately 18,000 customers at risk.
  - Since 2015, the Cloverdale – Dale No. 2 69 kV Line has experienced a total of five momentary outages and ten sustained outages.

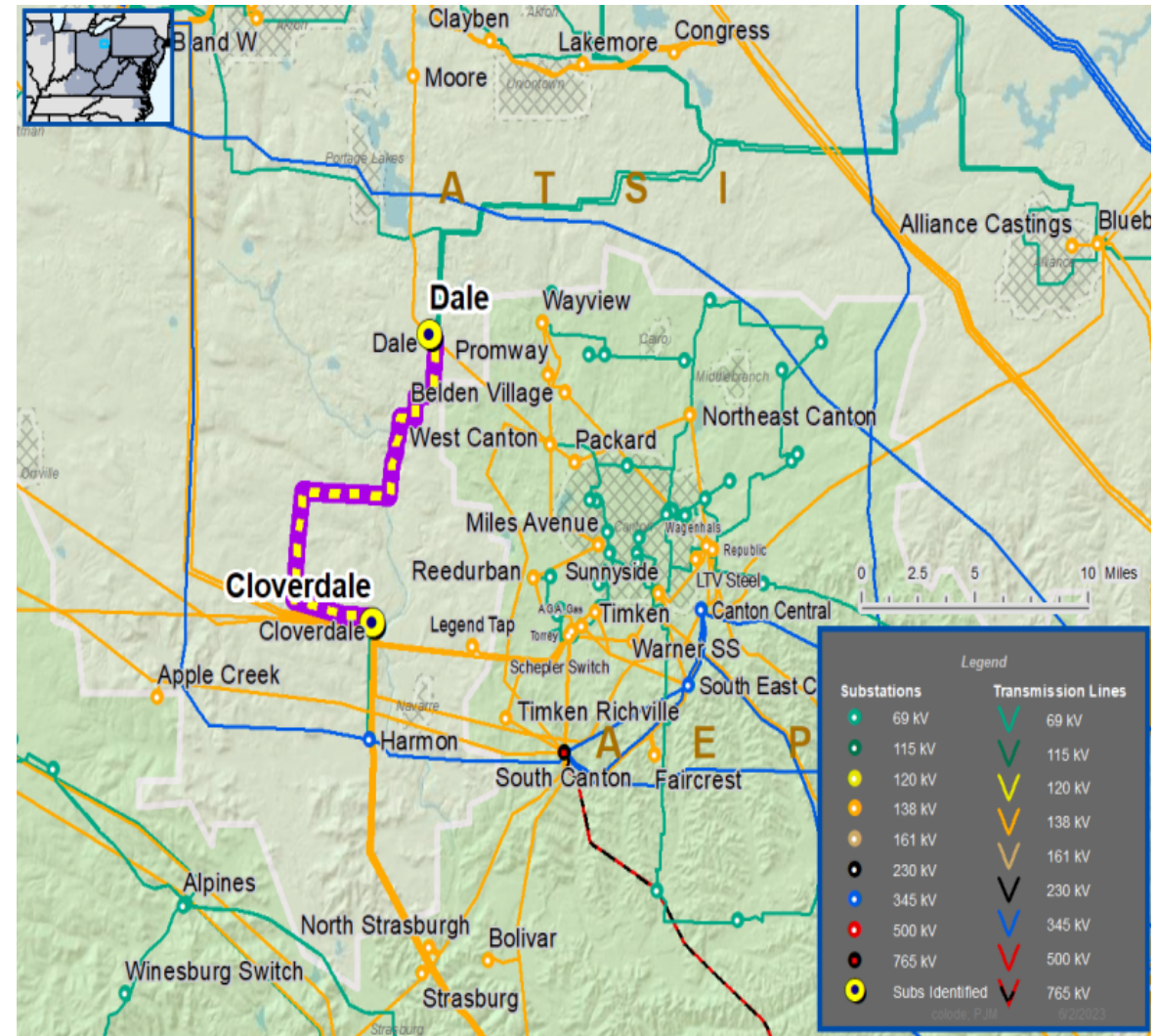



# ATSI Transmission Zone M-3 Process Cloverdale – Dale No. 2 69 kV Line

**Need Number:** ATSI-2023-012  
**Process Stage:** Submission of Supplemental Projects for Inclusion in the Local Plan – 9/24/2024

**Selected Solution:**

**Tiger 69 kV Ring Bus**

- Convert Tiger Substation into a four-breaker ring bus.

**Estimated Project Cost:** \$5.4M  
**Projected In-Service Date:** 6/19/2028  
**Supplemental Project ID:** s3498.1

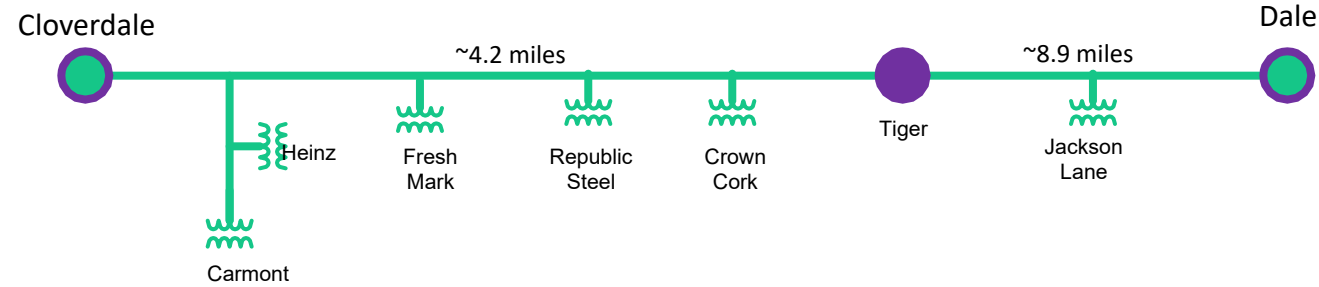

Legend	
500 kV	
345 kV	
138 kV	
69 kV	
34.5 kV	
23 kV	
New	

**Need Number:** ATSI-2024-008  
**Process Stage:** Submission of Supplemental Projects for Inclusion in the Local Plan – 9/24/2024  
**Previously Presented:** Need Meeting 02/16/2024  
 Solution Meeting – 05/17/2024

**Project Driver:**  
*Equipment Material Condition, Performance and Risk*

**Specific Assumption Reference:**

System Performance Projects Global Factors

- System reliability and performance
- Substation/line equipment limits

Upgrade Relay Schemes

- Obsolete and difficult to repair communication equipment (DTT, Blocking, etc.)
- Communication technology upgrades

**Problem Statement:**

- FirstEnergy has identified protection schemes using a certain vintage of relays and communication equipment that have a history of mis-operation.
- Proper operation of the protection scheme requires all the separate components perform adequately during a fault.
- In many cases the protection equipment cannot be repaired due to a lack of replacement parts and available expertise in the outdated technology.
- Transmission line ratings are limited by terminal equipment.

Continued on next slide...

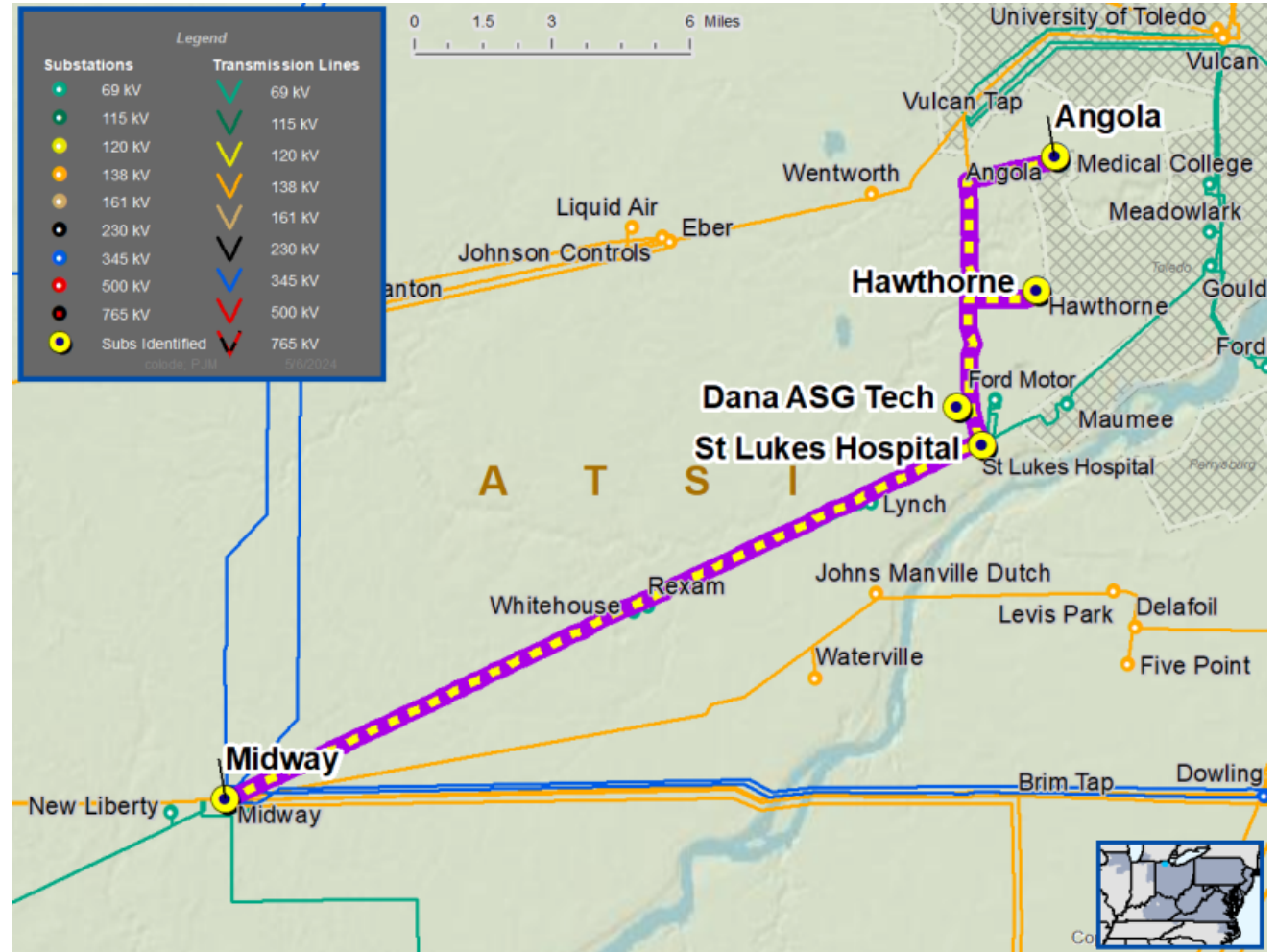



# ATSI Transmission Zone M-3 Process Misoperation Relays Projects

Need #	Transmission Line / Substation Locations	Existing Line Rating (SN / SE / WN / WE)	Existing Conductor Rating (SN / SE / WN/ WE)
ATSI-2024-008	Angola – Hawthorne 138 kV Line	287 / 342 / 333 / 380	288 / 353 / 333 / 427
ATSI-2024-008	Hawthorne – Dana Asg Tap 138 kV Line	288 / 353 / 333 / 427	288 / 353 / 333 / 427
ATSI-2024-008	Dana Asg Tap – St Lukes Tap 138 kV Line	288 / 353 / 333 / 427	288 / 353 / 333 / 427
ATSI-2024-008	St Lukes Tap – Midway 138 kV Line	288 / 353 / 333 / 427	288 / 353 / 333 / 427



**Need Number:** ATSI-2024-008  
**Process Stage:** Submission of Supplemental Projects for Inclusion in the Local Plan – 9/24/2024

**Selected Solution:**

Angola

- Replace circuit switcher with a new circuit breaker, replace line trap, limiting substation conductor and line relaying.

Midway

- Replace circuit breaker and associated disconnect switches, replace line trap and line relaying.

**Transmission Line Ratings:**

- **Angola- Hawthorne 138 kV Line Section**
  - Before Proposed Solution: 287 / 342 / 342 / 380 MVA (SN/SE/WN/WE)
  - After Proposed Solution: 288 / 353 / 333 / 427 MVA (SN/SE/WN/WE)

**Estimated Project Cost:** \$3.42 M  
**Projected In-Service:** 04/01/2029  
**Supplemental Project ID:** s3468.1

# ATSI Transmission Zone M-3 Process Angola- Midway 138 kV Misoperation Relays

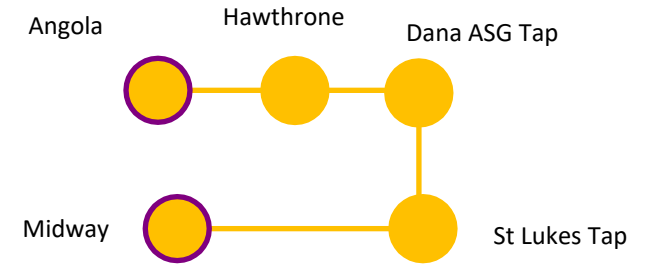

Legend	
500 kV	
345 kV	
138 kV	
69 kV	
34.5 kV	
23 kV	
New	

**Need Number:** ATSI-2024-023  
**Process Stage:** Submission of Supplemental Projects for Inclusion in the Local Plan – 9/24/2024  
**Previously Presented:** Need Meeting – 03/15/2024  
 Solution Meeting – 04/19/2024

**Supplemental Project Driver(s):**  
*Customer Service*

**Specific Assumption Reference(s):**  
 New customer connection request will be evaluated per FirstEnergy’s “Requirements for Transmission Connected Facilities” document and “Transmission Planning Criteria” document.

**Problem Statement**  
 New Customer Connection – A customer requested 69 kV service for approximately 21 MVA of load near the Cloverdale – Dale No. 2 69 kV Line. The customer location is approximately 1.2 miles from Cloverdale Substation.

Requested in-service date is April 2, 2022.

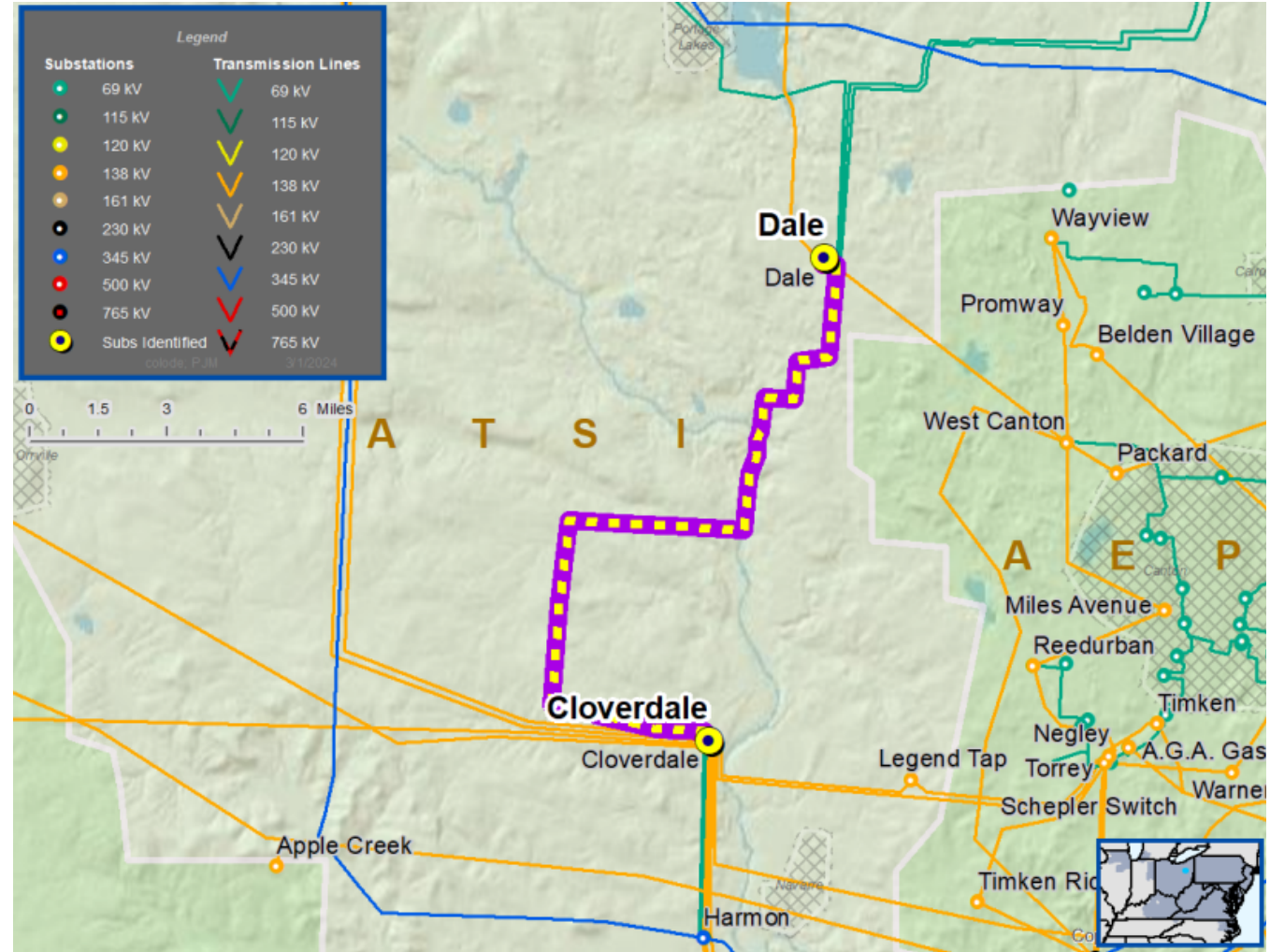



# ATSI Transmission Zone M-3 Process Cloverdale – Dale No.2 69 kV Line Customer Connection

**Need Number:** ATSI-2024-023  
**Process Stage:** Submission of Supplemental Projects for Inclusion in the Local Plan – 9/24/2024

- Selected Solution:**
- Install two main-line SCADA controlled switches
  - Install one tap-line SCADA controlled switch
  - Construct approximately 150 feet of 69 kV line to the customer substation
  - Revise relay settings at Cloverdale and Dale substations

**Estimated Project Cost:** \$0.63 M  
**Projected In-Service Date:** 2/7/2025  
**Supplemental Project ID:** s3453.1

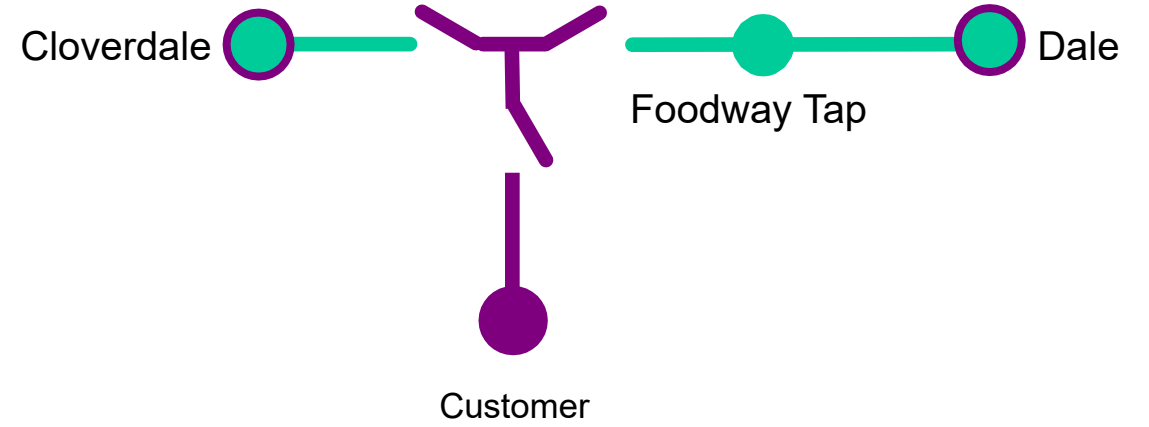

Legend	
500 kV	
345 kV	
138 kV	
69 kV	
34.5 kV	
23 kV	
New	



# ATSI Transmission Zone M-3 Process

## Galion – Roberts North 138 kV Line and Galion – Roberts South 138 kV Line

**Need Number:** ATSI-2024-024

**Process Stage:** Submission of Supplemental Projects for Inclusion in the Local Plan – 9/24/2024

**Previously Presented:** Need Meeting – 03/15/2024  
Solutions Meeting – 05/17/2024

**Project Driver:**  
*Equipment Material Condition, Performance and Risk*

- Specific Assumption Reference(s):**
- System Performance Global Factors
    - Past system reliability/performance
    - Substation/line equipment limits
  - Line Condition Rebuild/Replacement
    - Age/condition of wood pole transmission line structures

- Problem Statement**
- The double circuit Galion – Roberts North 138 kV Line and Galion – Roberts South 138 kV Line were constructed in 1948. The lines are approximately 22.2 miles in length with 129 shared wooden structures.
  - Recent inspections have indicated that the conductor and armor rod on the line have experienced aeolian vibrations, resulting in concentrated stress on the conductor and armor rod in various locations. As the temperature of the conductor material is increased, the overall tensile strength decreases and causes tensile overload and the failure of the conductor.
  - Since 2019, the Galion – Roberts North 138 kV Line had six unscheduled sustained outages.
  - Since 2019, the Galion – Roberts South 138 kV Line had two unscheduled sustained outages.

Continued on next slide...

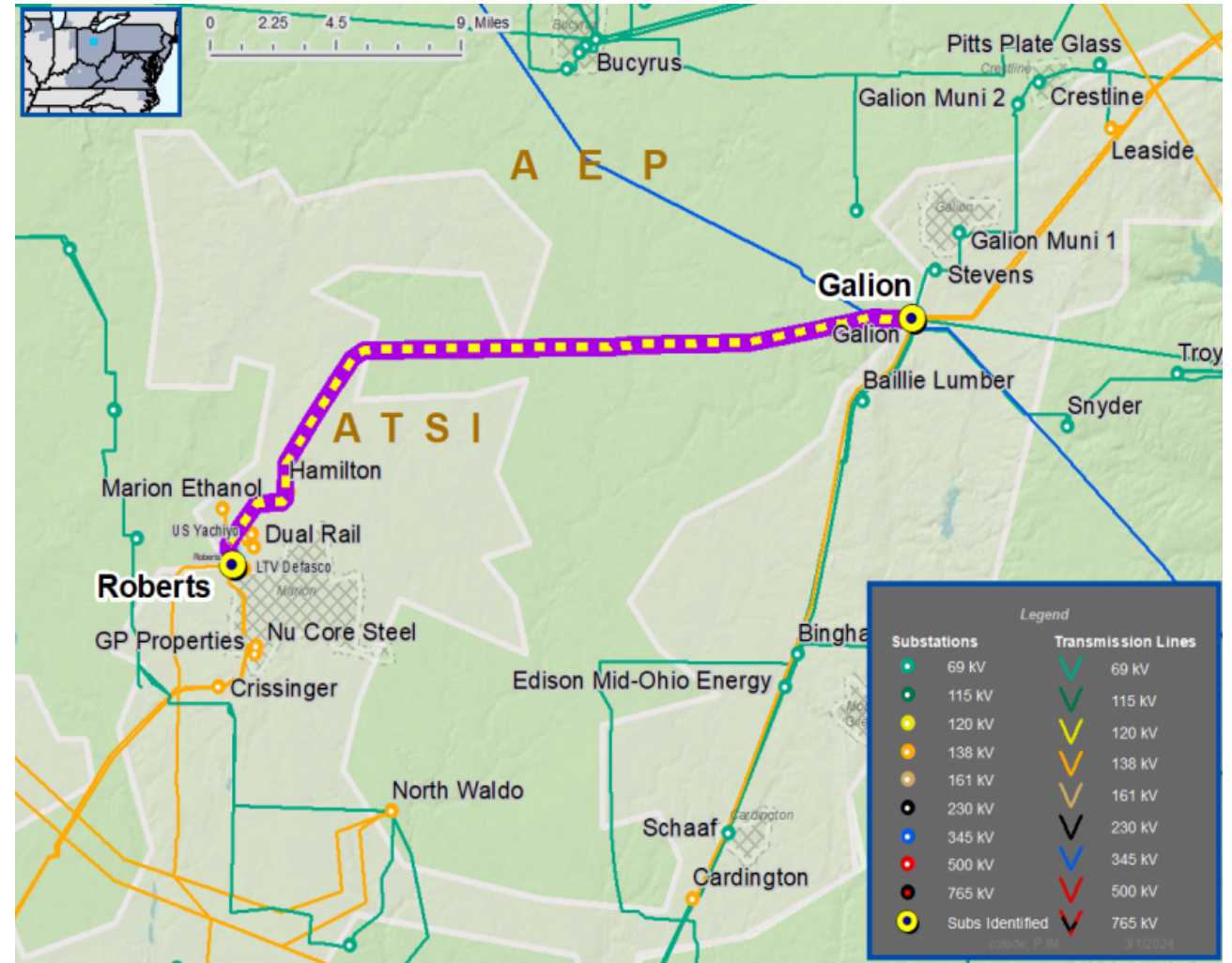



# ATSI Transmission Zone M-3 Process

## Galion – Roberts North 138 kV Line and Galion – Roberts South 138 kV Line

**Need Number:** ATSI-2024-024  
**Process Stage:** Submission of Supplemental Projects for Inclusion in the Local Plan – 9/24/2024  
**Previously Presented:** Need Meeting – 03/15/2024  
Solutions Meeting – 05/17/2024

### Transmission Line Ratings:

- Existing Galion – Marion Ethanol 138 kV Line Rating:
  - 160 / 192 / 180 / 228 MVA (SN/SE/WN/WE)
- Existing Marion Ethanol – Roberts North 138 kV Line Rating:
  - 160 / 192 / 180 / 228 MVA (SN/SE/WN/WE)
- Existing Galion – Hamilton Tap 138 kV Line Rating:
  - 195 / 209 / 217 / 229 MVA (SN/SE/WN/WE)
- Existing Hamilton Tap – Dual Rail Tap 138 kV Line Rating:
  - 200 / 242 / 226 / 286 MVA (SN/SE/WN/WE)
- Existing Dual Rail Tap – Roberts South 138 kV Line Rating:
  - 195 / 209 / 217 / 229 MVA (SN/SE/WN/WE)

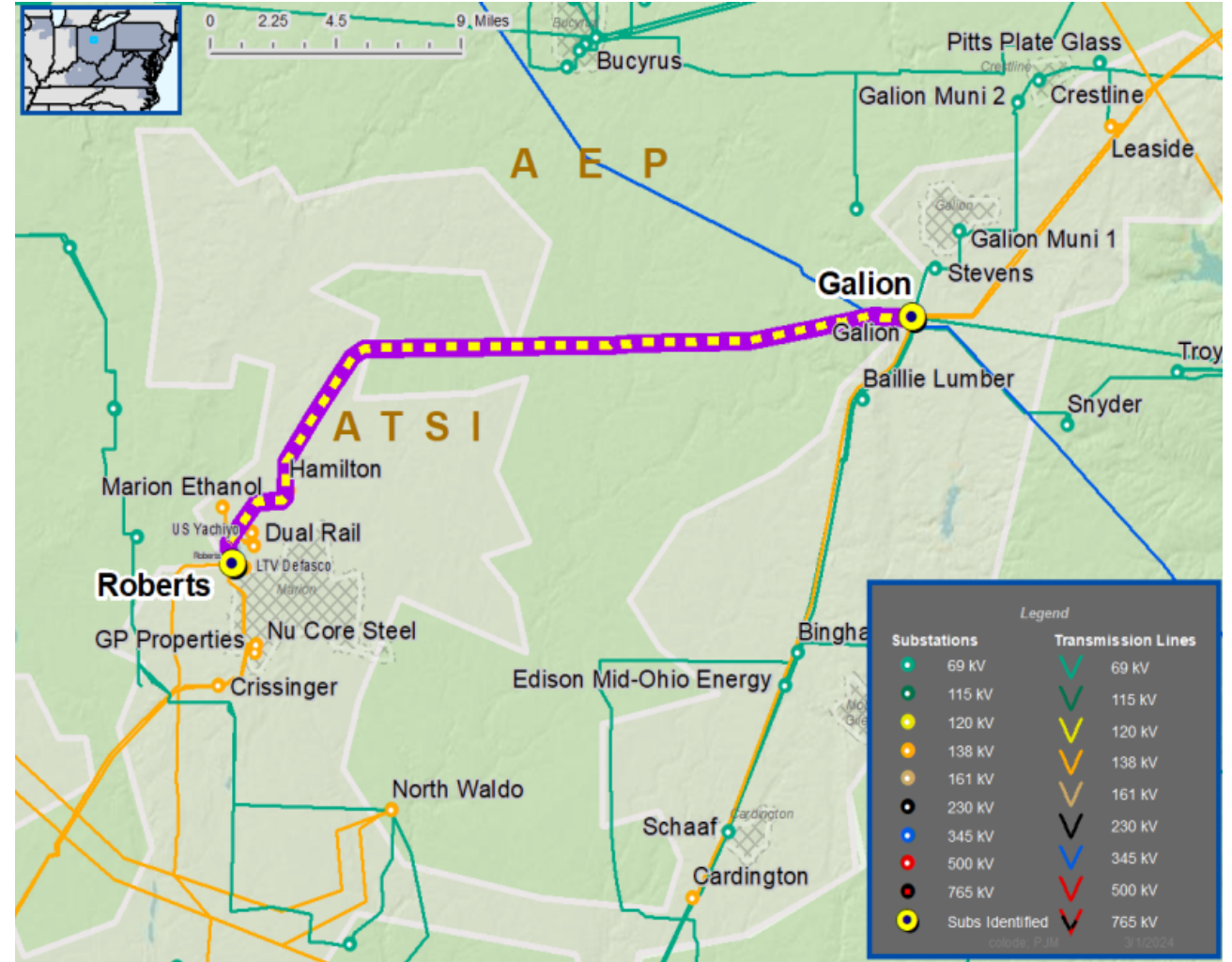



# ATSI Transmission Zone M-3 Process

## Galion – Roberts North 138 kV Line and Galion – Roberts South 138 kV Line

**Need Number:** ATSI-2024-024  
**Process Stage:** Submission of Supplemental Projects for Inclusion in the Local Plan – 9/24/2024

**Selected Solution:**

**Galion – Roberts North 138 kV Line and Galion – Roberts South 138 kV Line**

- Rebuild the double circuit Galion – Roberts North 138 kV Line and Galion – Roberts South 138 kV Line on shared structures.

**Galion**

- Replace circuit breakers and associated disconnect switches.

**Roberts**

- Replace substation conductor.

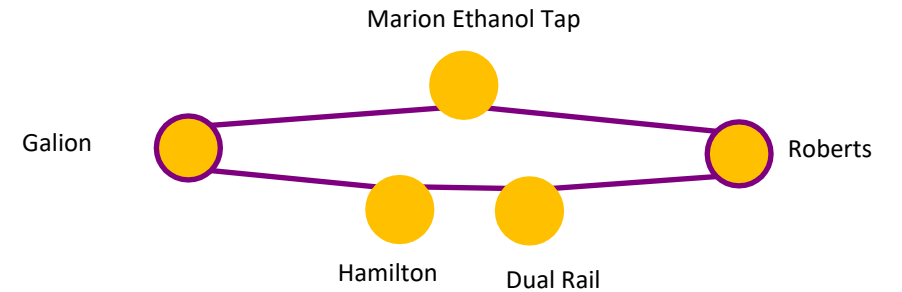

Legend	
500 kV	Red line
345 kV	Blue line
138 kV	Yellow line
69 kV	Cyan line
34.5 kV	Red line
23 kV	Light green line
New	Purple line

# ATSI Transmission Zone M-3 Process

## Galion – Roberts North 138 kV Line and Galion – Roberts South 138 kV Line

**Need Number:** ATSI-2024-024  
**Process Stage:** Submission of Supplemental Projects for Inclusion in the Local Plan – 9/24/2024

**Transmission Line Ratings:**

- **Galion- Marion Ethanol Tap 138kV Line**
  - Before Proposed Solution: 160 / 192 / 180 / 228 MVA (SN/SE/WN/WE)
  - After Proposed Solution: 278 / 339 / 315 / 401 MVA (SN/SE/WN/WE)
- **Marion Ethanol Tap- Roberts North 138V Line**
  - Before Proposed Solution: 160 / 192 / 180 / 228 MVA (SN/SE/WN/WE)
  - After Proposed Solution: 278 / 339 / 315 / 401 MVA (SN/SE/WN/WE)

**Galion – Hamilton Tap 138 kV Line Rating:**

- Before Proposed Solution: 195 / 209 / 217 / 229 MVA (SN/SE/WN/WE)
- After Proposed Solution: 278 / 339 / 315 / 401 MVA (SN/SE/WN/WE)

**Hamilton Tap – Dual Rail Tap 138 kV Line Rating:**

- Before Proposed Solution: 200 / 242 / 226 / 286 MVA (SN/SE/WN/WE)
- After Proposed Solution: 278 / 339 / 315 / 401 MVA (SN/SE/WN/WE)

**Dual Rail Tap – Roberts South 138 kV Line Rating:**

- Before Proposed Solution: 195 / 209 / 217 / 229 MVA (SN/SE/WN/WE)
- After Proposed Solution: 278 / 339 / 315 / 401 MVA (SN/SE/WN/WE)

**Estimated Project Cost:** \$66.5 M  
**Projected In-Service:** 8/27/2026  
**Supplemental Project ID:** s3469.1

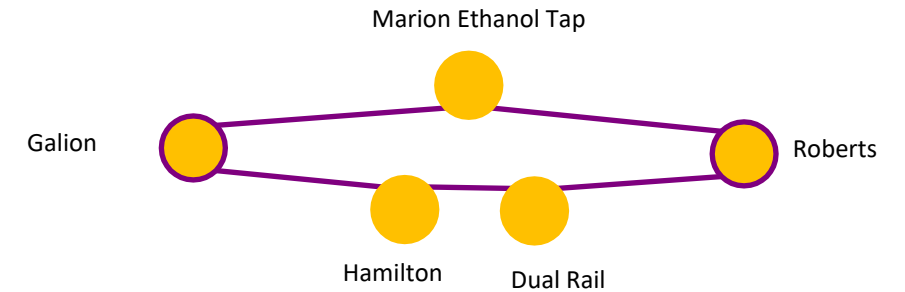

Legend	
500 kV	
345 kV	
138 kV	
69 kV	
34.5 kV	
23 kV	
New	

# ATSI Transmission Zone M-3 Process London – Tangy 138 kV Line Customer Connection

**Need Number:** ATSI-2024-028

**Process Stage:** Submission of Supplemental Projects for Inclusion in the Local Plan – 9/24/2024

**Previously Presented:** Need Meeting – 02/16/2024  
Solution Meeting – 4/19/2024

**Supplemental Project Driver(s):**  
*Customer Service*

**Specific Assumption Reference(s):**  
New customer connection request will be evaluated per FirstEnergy’s “Requirements for Transmission Connected Facilities” document and “Transmission Planning Criteria” document.

**Problem Statement**  
New Customer Connection – Customer is requesting a temporary connection on the London – Tangy 138 kV Line for approximately 8 months. The anticipated load of the new customer connection is 30 MVA.

Requested in-service date is 6/1/2024.

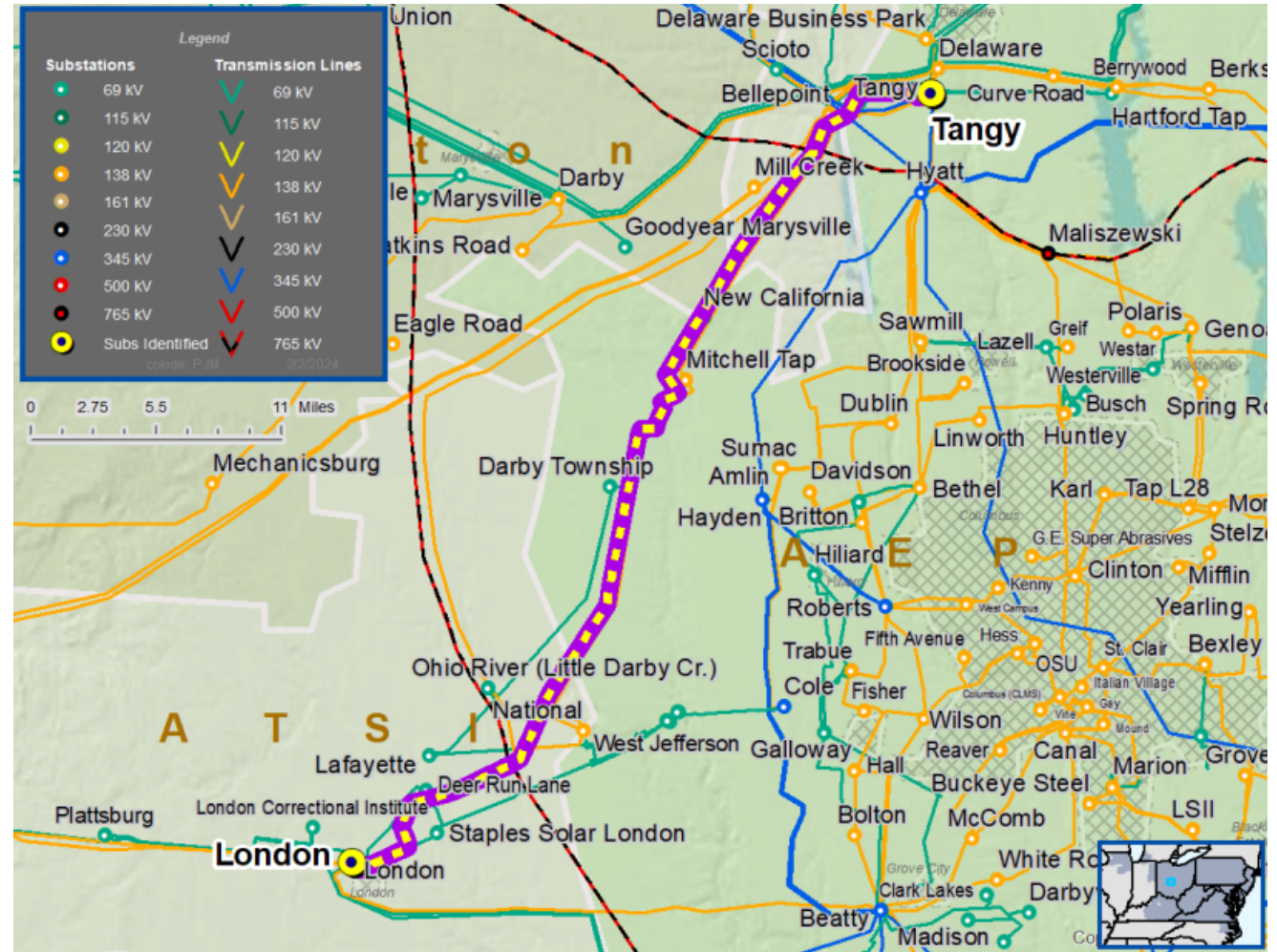



# ATSI Transmission Zone M-3 Process London – Tangy 138 kV Line Customer Connection

**Need Number:** ATSI-2024-028  
**Process Stage:** Submission of Supplemental Projects for Inclusion in the Local Plan – 9/24/2024

- Selected Solution:**
- Install two main-line switches
  - Construct approximately 0.1 miles of 138 kV line to the customer substation
  - Adjust relay settings at London and Tangy substations

**Estimated Project Cost:** \$0.00 M (Fully Reimbursable by Customer)  
**Project In-Service Date:** 5/24/2024  
**Supplemental Project ID:** s3454.1

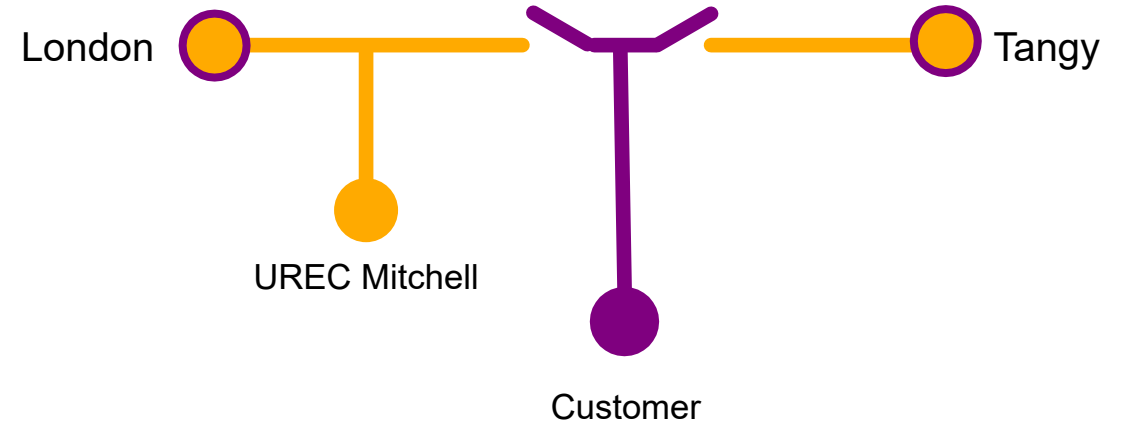

Legend	
500 kV	
345 kV	
138 kV	
69 kV	
34.5 kV	
23 kV	
New	

**Need Number:** ATSI-2024-029

**Process Stage:** Submission of Supplemental Projects for Inclusion in the Local Plan - 9/24/2024

**Previously Presented:** Need Meeting – 03/15/2024  
Solution Meeting – 04/19/2024

**Supplemental Project Driver(s):**  
*Operational Flexibility and Efficiency*

**Specific Assumption Reference(s):**  
System Performance Global Factors

- System reliability and performance

**Problem Statement:**

- The existing Black River - Republic Arc 138 kV Line and Black River - Republic Vine 138 kV Line are networked through customer owned substations.
- Since the customer substations are in the transmission network path, transmission flow through customer owned equipment is possible.
- The existing customer substation, Republic Arc, has minimal load.
- The existing customer substation, Republic Vine, is operational but loads are lower than historical levels.

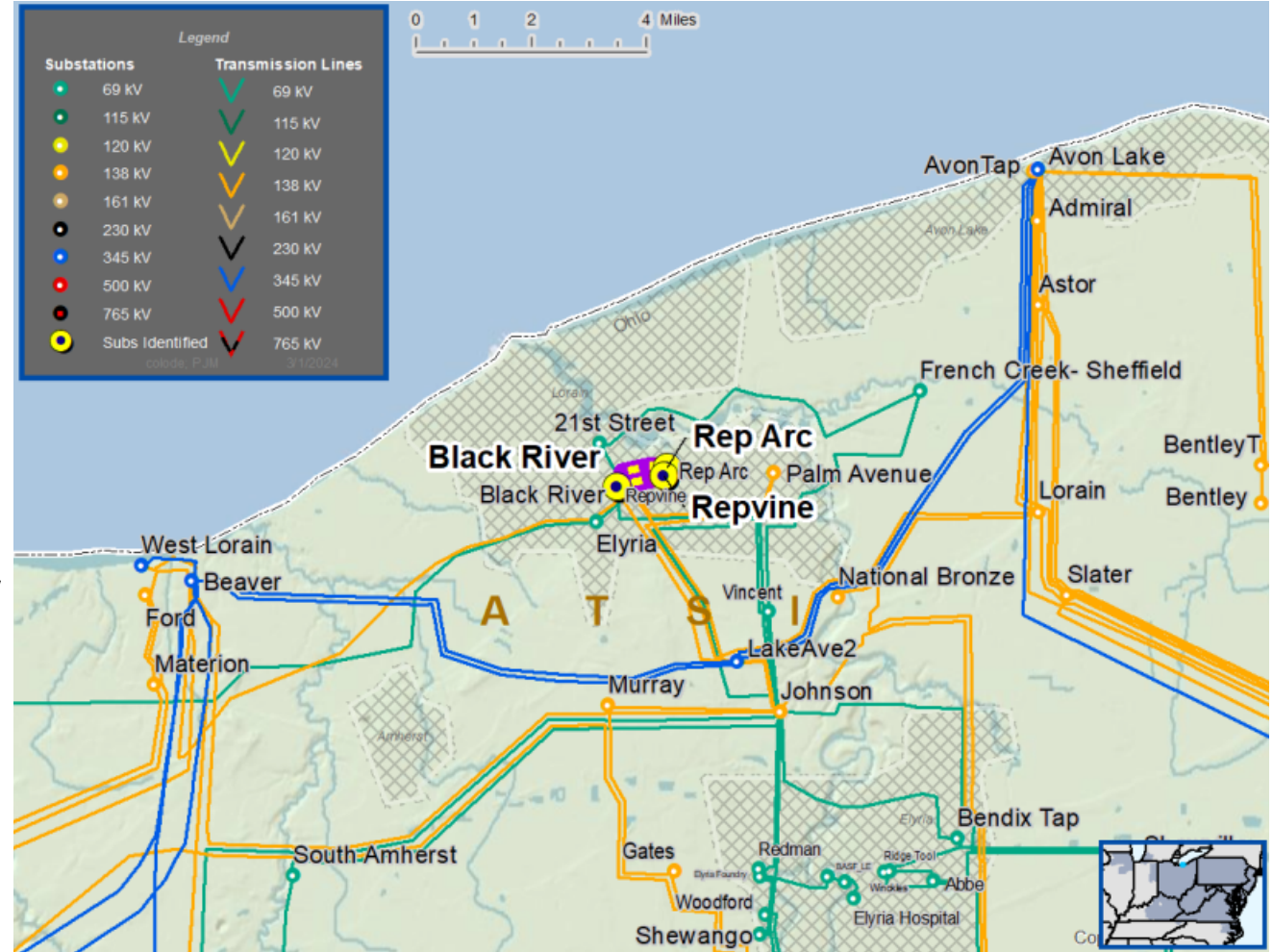



# ATSI Transmission Zone M-3 Process Lorain, Ohio

**Need Number:** ATSI-2024-029  
**Process Stage:** Submission of Supplemental Projects for Inclusion in the Local Plan – 9/24/2024

**Selected Solution:**

- Cut open the Republic Arc - Republic Vine 138 kV Line and install a normally open switch.
- Adjust protection setting at Black River, Republic Arc, and Republic Vine substations.

**Estimated Project Cost:** \$0.40 M  
**Project In-Service Date:** 6/2/2025  
**Supplemental Project ID:** s3455.1

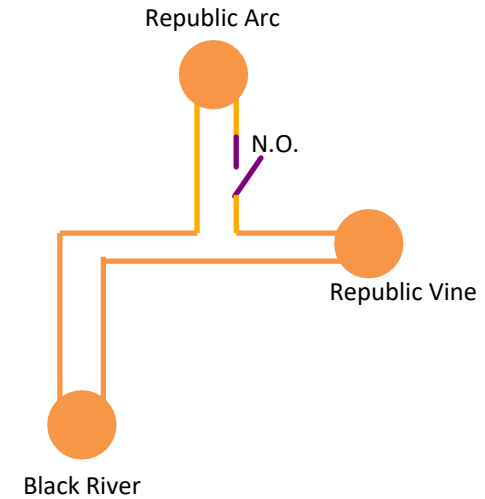

Legend	
500 kV	
345 kV	
138 kV	
69 kV	
34.5 kV	
23 kV	
New	





# ATSI Transmission Zone M-3 Process Evergreen – Highland No. 3 138 kV Line Customer Connection

**Need Number:** ATSI-2024-030  
**Process Stage:** Submission of Supplemental Projects for Inclusion in the Local Plan – 9/24/2024  
**Previously Presented:** Need Meeting – 03/15/2024  
 Solution Meeting – 04/19/2024

**Supplemental Project Driver(s):**  
 Customer Service

**Specific Assumption Reference(s):**  
 New customer connection request will be evaluated per FirstEnergy’s “Requirements for Transmission Connected Facilities” document and “Transmission Planning Criteria” document.

**Problem Statement**

New Customer Connection – A customer requested 138 kV service for approximately 17 MVA of initial load near the Evergreen – Highland No. 3 138 kV Line. The customer location is approximately 1.1 miles from Evergreen Substation.

Requested in-service date is June 20, 2025.





# ATSI Transmission Zone M-3 Process Evergreen – Highland No. 3 138 kV Line Customer Connection

**Need Number:** ATSI-2024-030  
**Process Stage:** Submission of Supplemental Projects for Inclusion in the Local Plan – 9/24/2024

**Selected Solution:**

- Install one main-line SCADA controlled switch
- Install one tap-line SCADA controlled switch
- Construct approximately 0.2 miles of 138 kV line to the customer substation
- Revise relay settings at Evergreen and Highland substations

**Estimated Project Cost:** \$1.40 M  
**Projected In-Service Date:** 5/1/2025  
**Supplemental Project ID:** s3456.1

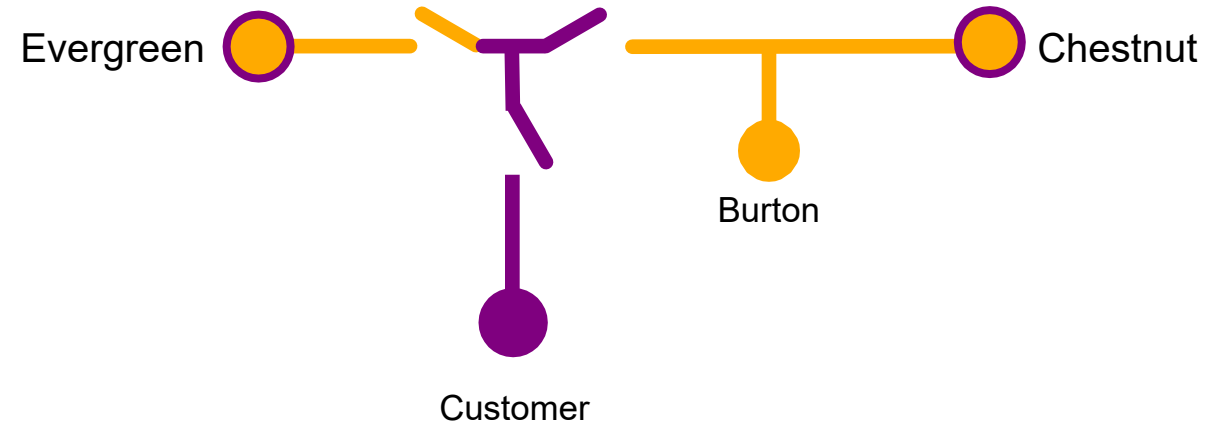

Legend	
500 kV	
345 kV	
138 kV	
69 kV	
34.5 kV	
23 kV	
New	

**Need Number:** ATSI-2024-036

**Process Stage:** Submission of Supplemental Projects for Inclusion in the Local Plan – 9/24/2024

**Previously Presented:** Need Meeting – 05/17/2024  
Solution Meeting – 06/14/2024

**Supplemental Project Driver(s):**  
*Customer Service*

**Specific Assumption Reference(s):**  
New customer connection request will be evaluated per FirstEnergy’s “Requirements for Transmission Connected Facilities” document and “Transmission Planning Criteria” document.

**Problem Statement**  
New Customer Connection – A retail customer requested 69 kV service for load of approximately 5 MVA near the Abbe – Medina 69 kV Line. The service request location is approximately 0.1 miles from Abbe Substation.

**Requested In-Service Date:**  
September 30, 2025

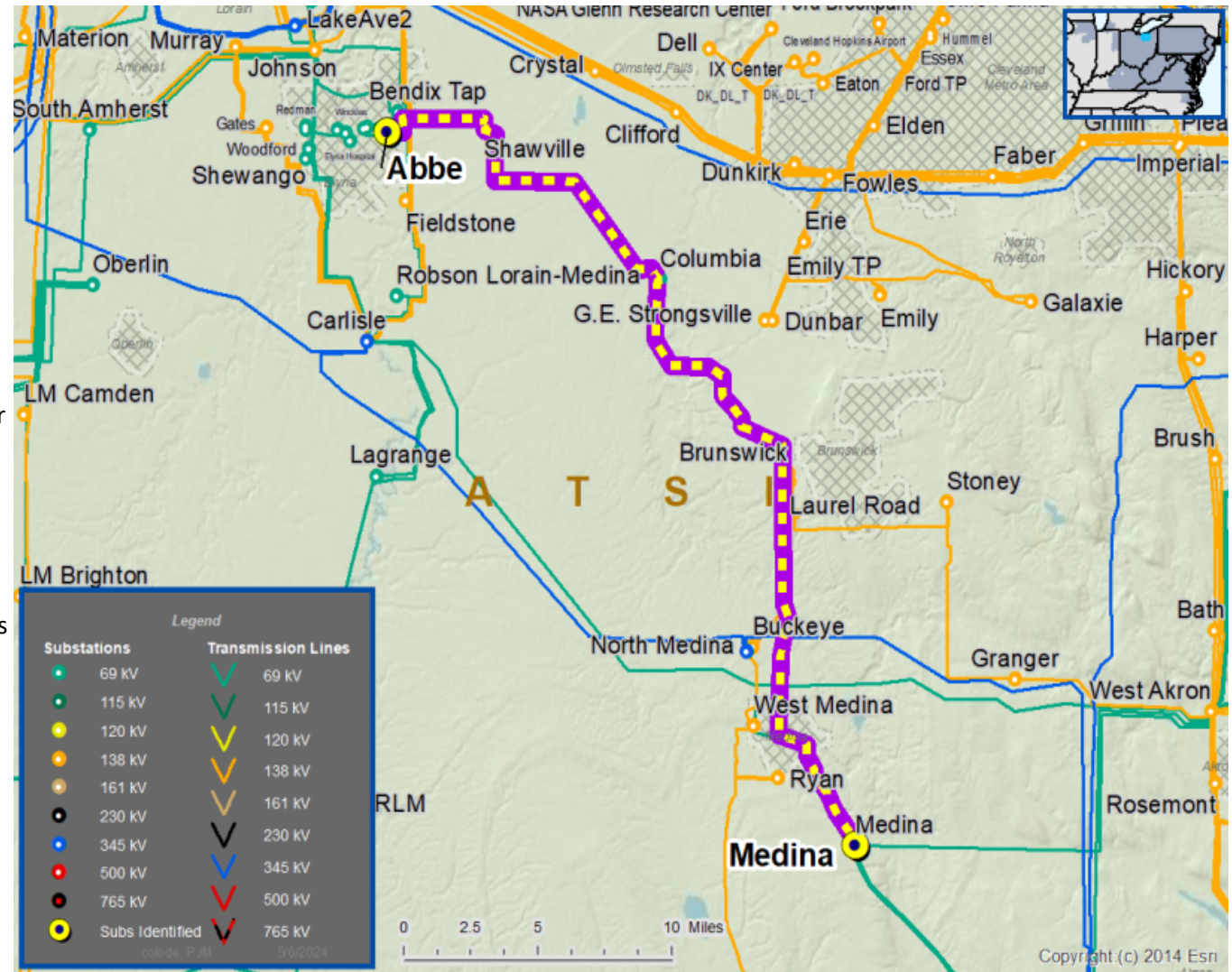



# ATSI Transmission Zone M-3 Process Abbe – Medina 69 kV Line Customer Connection

**Need Number:** ATSI-2024-036  
**Process Stage:** Submission of Supplemental Projects for Inclusion in the Local Plan – 9/24/2024

- Selected Solution:**  
**138 kV Transmission Line Tap**
- Install one tap-line SCADA controlled switch
  - Construct 0.1 miles of 69 kV line extension.
  - Adjust relay settings at Abbe and Medina substations
  - Install revenue metering

**Estimated Project Cost:** \$0.2M  
**Projected In-Service:** 8/29/2025  
**Supplemental Project ID:** s3500.1

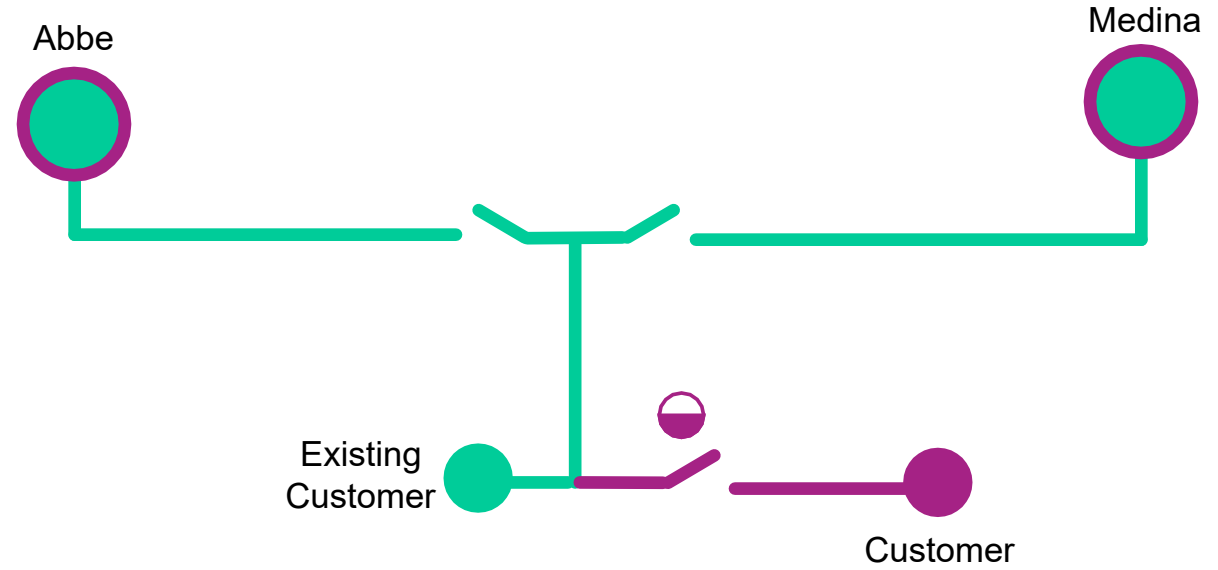

Legend	
500 kV	
345 kV	
138 kV	
69 kV	
34.5 kV	
23 kV	
New	

**Need Number:** ATSI-2024-041  
**Process Stage:** Submission of Supplemental Projects for Inclusion in the Local Plan – 9/24/2024  
**Previously Presented:** Need Meeting – 05/17/2024  
 Solution Meeting – 06/14/2024

**Supplemental Project Driver(s):**  
*Customer Service*

**Specific Assumption Reference(s):**  
 New customer connection request will be evaluated per FirstEnergy’s “Requirements for Transmission Connected Facilities” document and “Transmission Planning Criteria” document.

**Problem Statement**  
 New Customer Connection – Ohio Edison distribution requested 138 kV service for load of approximately 11 MVA near the Cloverdale - Harmon 138 kV Line. The service request location is approximately 1 mile from Cloverdale Substation.

**Requested In-Service Date:**  
 December 31, 2025

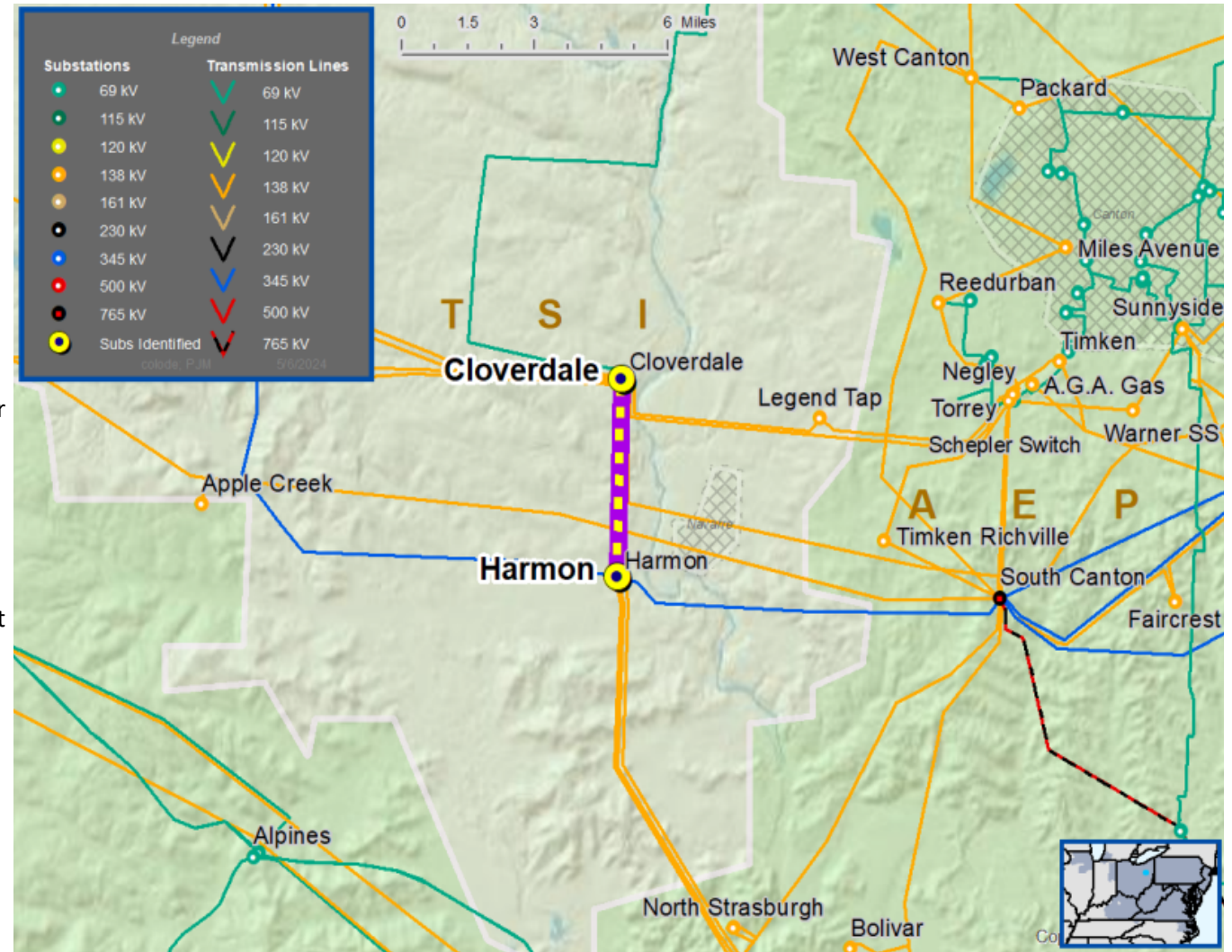



# ATSI Transmission Zone M-3 Process Cloverdale – Harmon 138 kV Line Customer Connection

**Need Number:** ATSI-2024-041  
**Process Stage:** Submission of Supplemental Projects for Inclusion in the Local Plan – 9/24/2024

- Selected Solution:**  
**138 kV Transmission Line Tap**
- Install one tap-line SCADA controlled switch
  - Install SCADA controlled on existing main-line switch
  - Construct 0.6 miles of 138 kV line extension
  - Adjust relay settings at Cloverdale and Harmon substations
  - Install revenue metering

**Estimated Project Cost:** \$0.7M  
**Projected In-Service:** 5/31/2026  
**Supplemental Project ID:** s3499.1

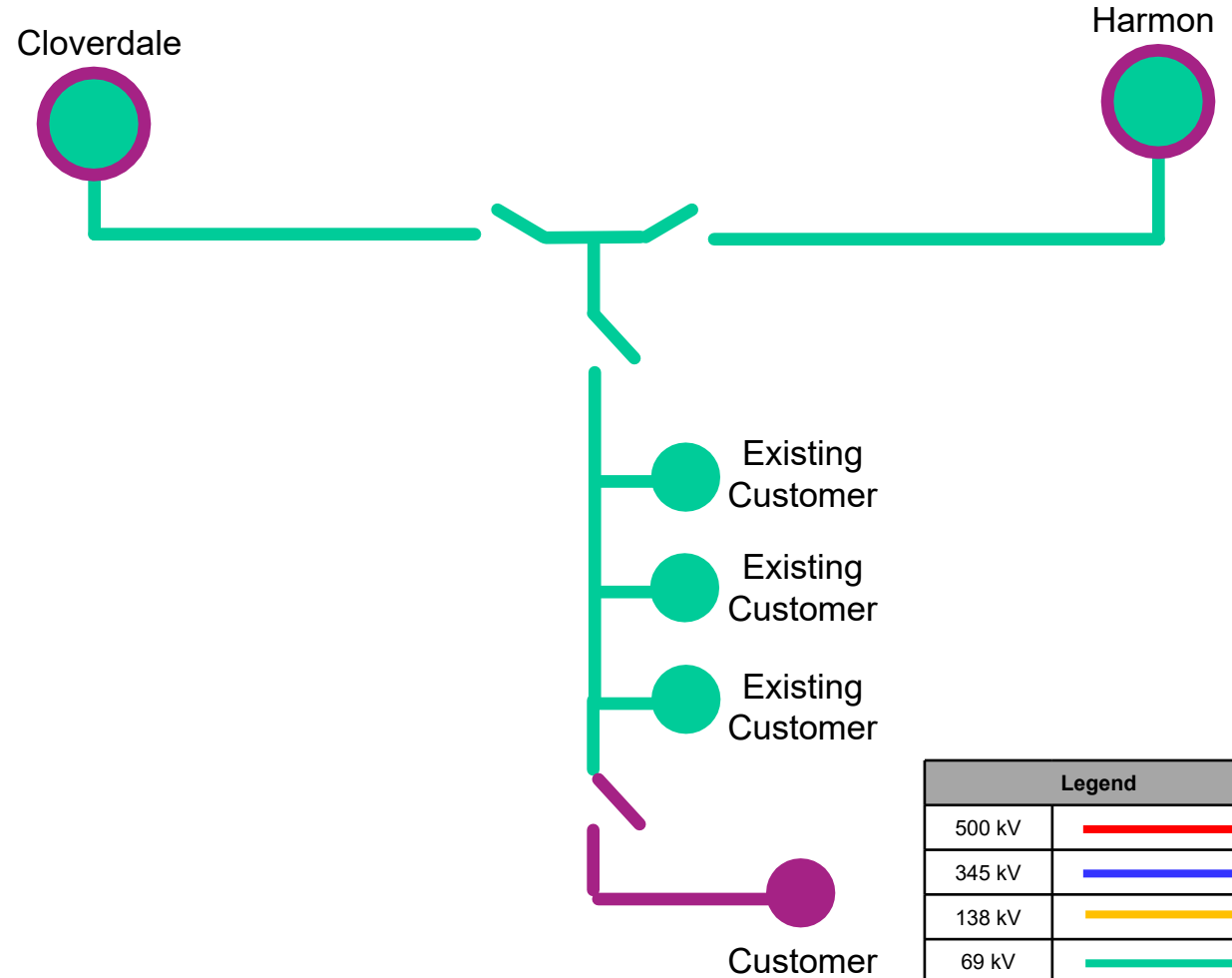

Legend	
500 kV	
345 kV	
138 kV	
69 kV	
34.5 kV	
23 kV	
New	

**Need Number:** ATSI-2024-020  
**Process Stage:** Submission of Supplemental Projects for Inclusion in the Local Plan – 9/24/2024  
**Previously Presented:** Need Meeting – 02/16/2024  
 Solution Meeting – 07/19/2024

**Supplemental Project Driver(s):**  
*Customer Service*

**Specific Assumption Reference(s):**  
 New customer connection request will be evaluated per FirstEnergy’s “Requirements for Transmission Connected Facilities” document and “Transmission Planning Criteria” document.

**Problem Statement**  
 New Customer Connection – Ohio Edison Distribution has requested a new 138 kV delivery point near the London - Tangy 138 kV Line. The anticipated load of the new customer connection is 12 MVA.

**Forecasted In-Service Date:**  
 June 1, 2024

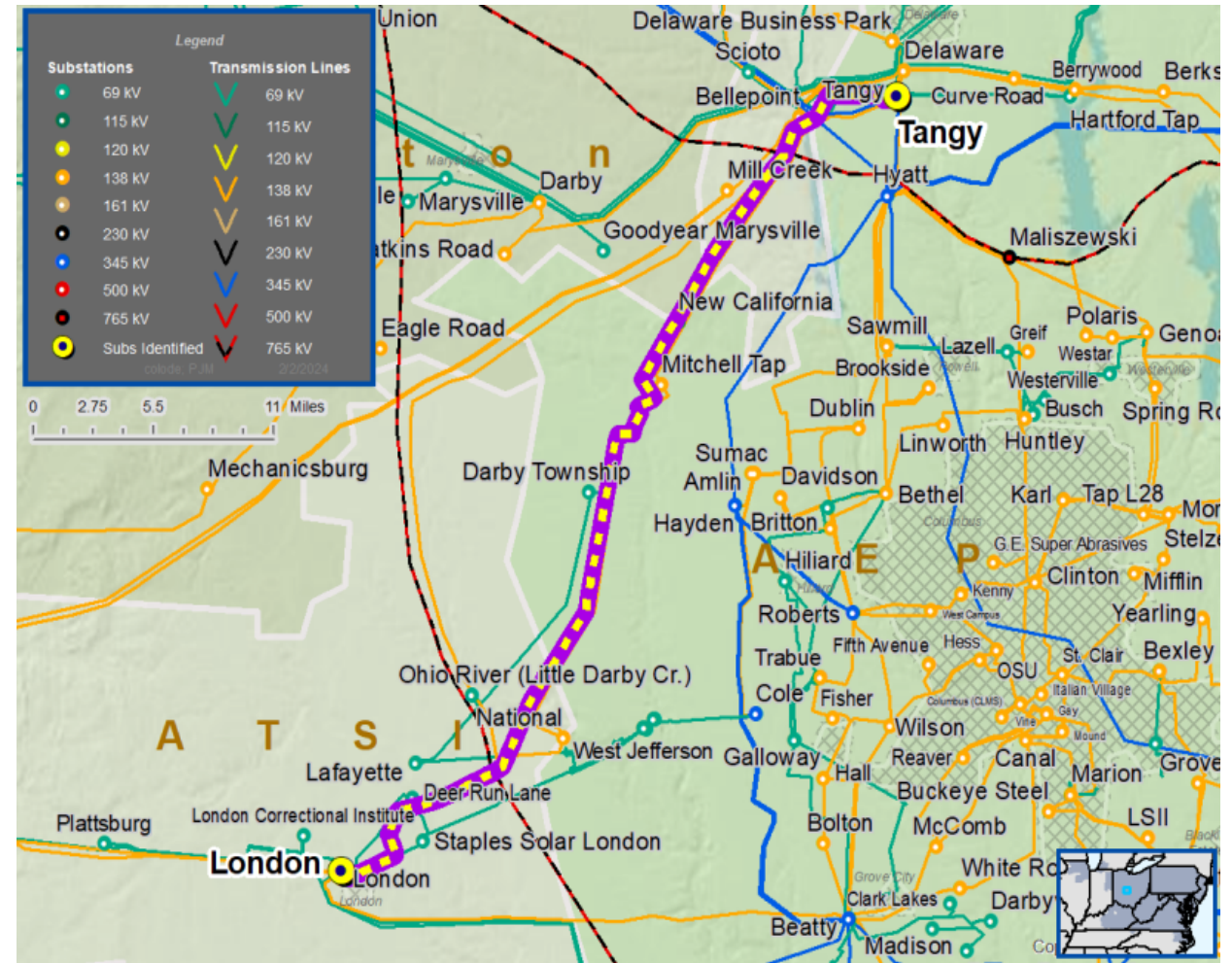



# ATSI Transmission Zone M-3 Process London – Tangy 138 kV Line Customer Connection

**Need Number:** ATSI-2024-020  
**Process Stage:** Submission of Supplemental Projects for Inclusion in the Local Plan – 9/24/2024

**Selected Solution:**

**138 kV Transmission Line Tap**

- Install two main-line SCADA controlled switches
- Install one tap-line SCADA controlled switch
- Construct 0.1 miles of 138 kV line extension.
- Adjust relay settings at London and Tangy substations
- Install revenue metering

**Estimated Project Cost:** \$1.6M  
**Projected In-Service:** 6/3/2026  
**Supplemental Project ID:** s3521.1

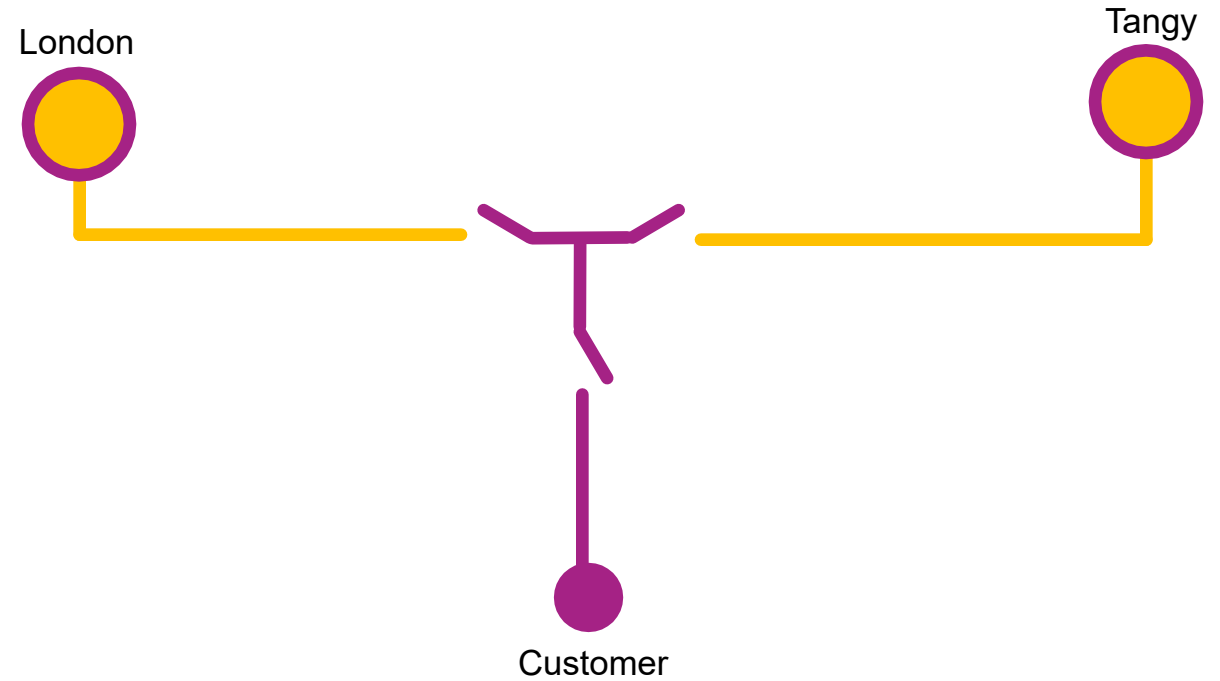

Legend	
500 kV	
345 kV	
138 kV	
69 kV	
34.5 kV	
23 kV	
New	



**Need Number:** ATSI-2024-042  
**Process Stage:** Submission of Supplemental Projects for Inclusion in the Local Plan – 9/24/2024  
**Previously Presented:** Need Meeting – 06/14/2024  
 Solution Meeting – 07/19/2024

**Supplemental Project Driver(s):**  
*Customer Service*

**Specific Assumption Reference(s):**  
 New customer connection request will be evaluated per FirstEnergy’s “Requirements for Transmission Connected Facilities” document and “Transmission Planning Criteria” document.

**Problem Statement**  
 New Customer Connection – Ohio Edison Distribution has requested a new 69 kV service load for approximately 11 MVA near the Bingham – Cook 69 kV Line. The request is approximately two miles from Cook Substation.

**Requested In-Service Date:**  
 June 1, 2025

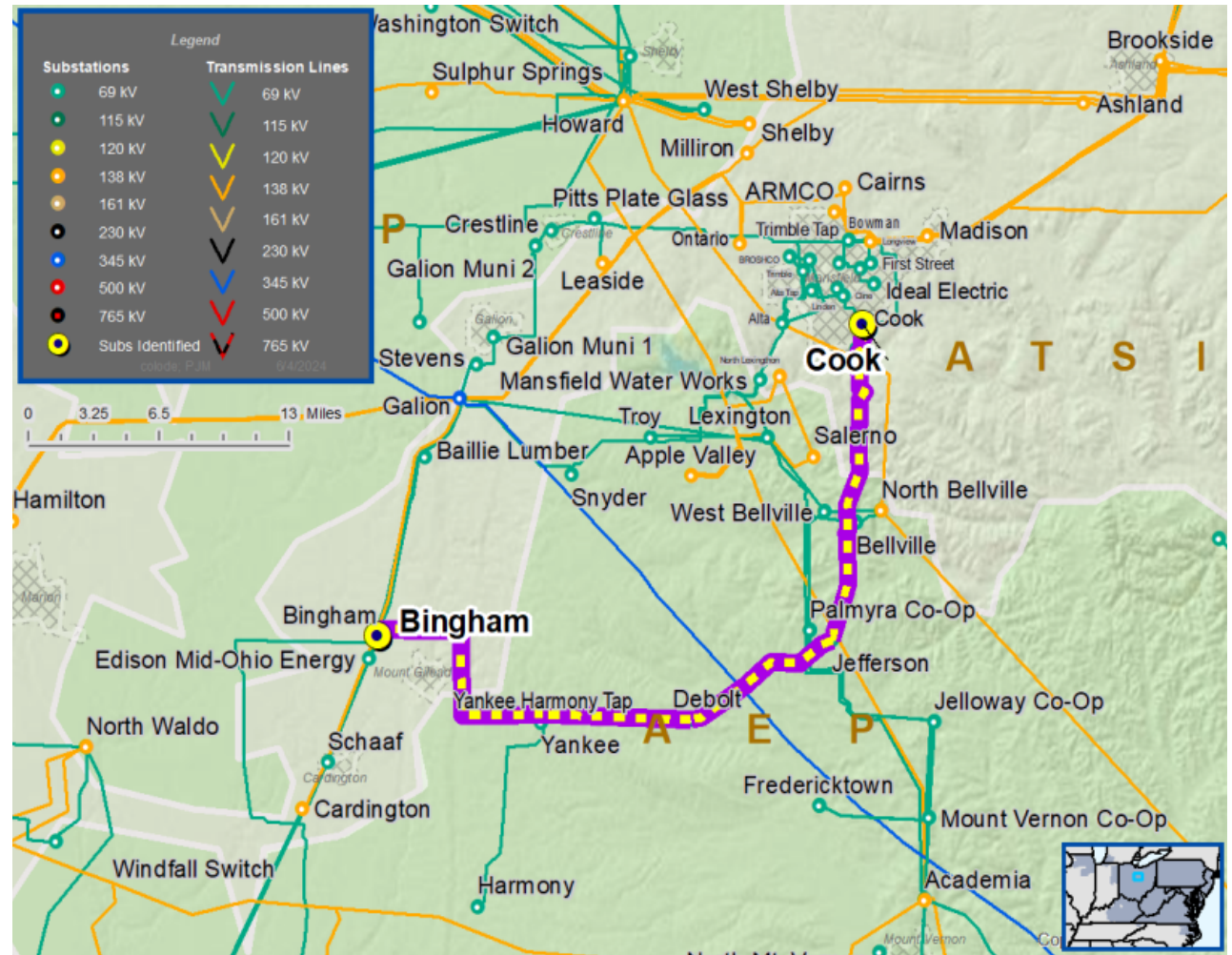



# ATSI Transmission Zone M-3 Process Bingham – Cook 69 kV Line Customer Connection

**Need Number:** ATSI-2024-042  
**Process Stage:** Submission of Supplemental Projects for Inclusion in the Local Plan – 9/24/2024

**Selected Solution:**

**69 kV Transmission Line Tap**

- Install two main-line SCADA controlled switches
- Install one tap-line SCADA controlled switch
- Construct 0.1 miles of 69 kV line extension.
- Adjust relay settings at Bingham and Cook substations
- Install revenue metering

**Estimated Project Cost:** \$1.21M  
**Projected In-Service:** 12/27/2027  
**Supplemental Project ID:** s3522.1

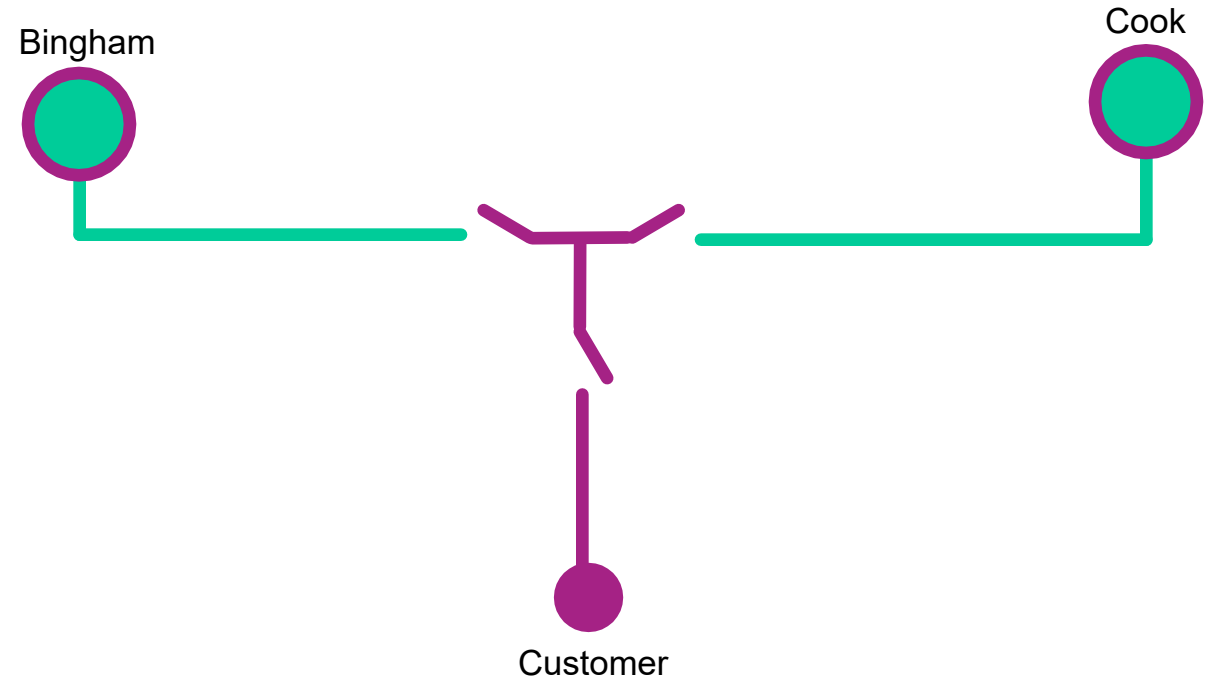

Legend	
500 kV	
345 kV	
138 kV	
69 kV	
34.5 kV	
23 kV	
New	



# ATSI Transmission Zone M-3 Process Adams - Shinrock 69 kV Line Customer Connection

**Need Number:** ATSI-2024-043  
**Process Stage:** Submission of Supplemental Projects for Inclusion in the Local Plan -9/24/2024  
**Previously Presented:** Need Meeting – 06/14/2024  
 Solution Meeting – 07/19/2024

**Supplemental Project Driver(s):**  
 Customer Service

**Specific Assumption Reference(s):**  
 New customer connection request will be evaluated per FirstEnergy’s “Requirements for Transmission Connected Facilities” document and “Transmission Planning Criteria” document.

**Problem Statement**  
 New Customer Connection – A retail customer is requesting to retire an existing 69 kV delivery point on the Adams - Shinrock 69 kV Line. In addition, the customer is requesting a new 69 kV delivery point on the same transmission line to replace the retired delivery point which will have an anticipated load of 35 MVA. The request is approximately 500 feet from Adams Substation.

**Forecasted In-Service Date:**  
 October 31, 2025

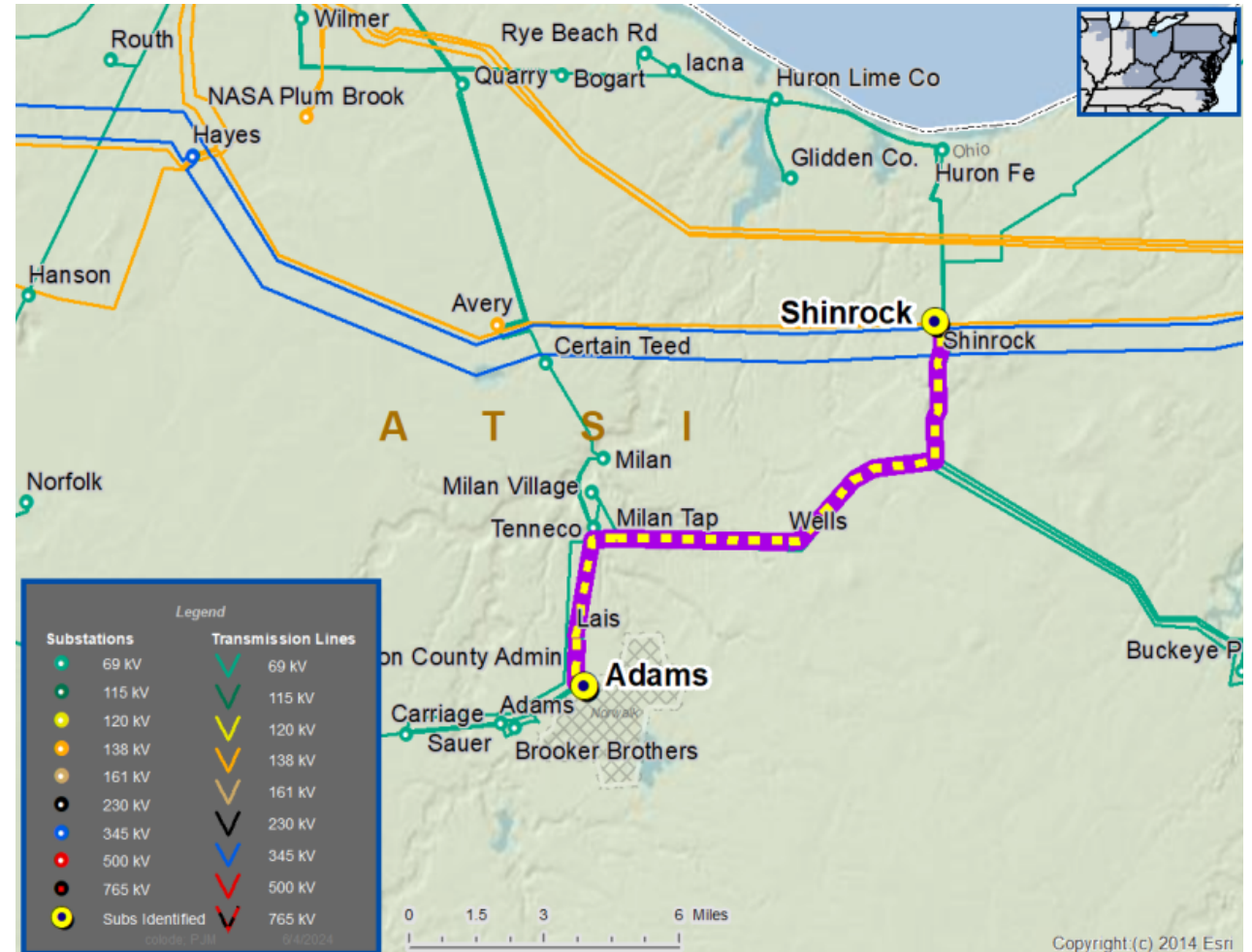



# ATSI Transmission Zone M-3 Process Adams - Shinrock 69 kV Line Customer Connection

**Need Number:** ATSI-2024-043  
**Process Stage:** Submission of Supplemental Projects for Inclusion in the Local Plan – 9/24/2024

**Selected Solution:**

**69 kV Transmission Line Tap**

- Install one tap-line SCADA controlled switch
- Construct a span of 69 kV line extension.
- Adjust relay settings at Adams and Shinrock substations
- Install revenue metering

**Estimated Project Cost:** \$0.15 M  
**Projected In-Service:** 10/31/2025  
**Supplemental Project ID:** s3523.1

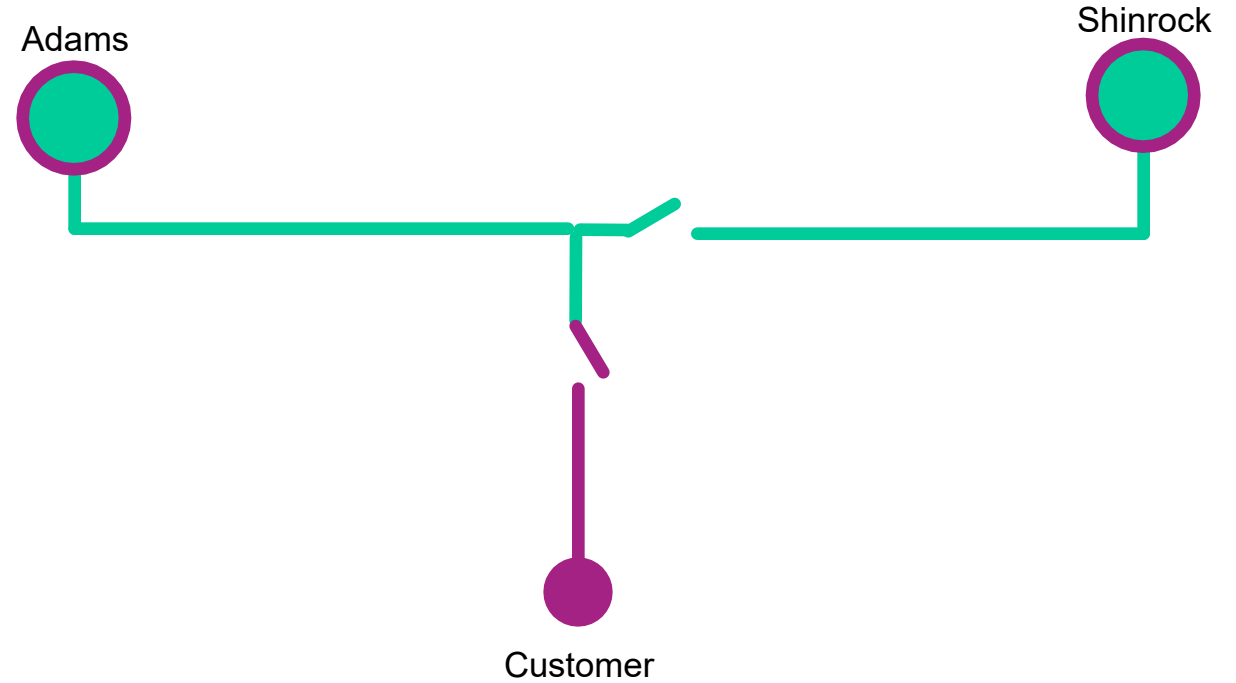

Legend	
500 kV	
345 kV	
138 kV	
69 kV	
34.5 kV	
23 kV	
New	



# ATSI Transmission Zone M-3 Process East Springfield 138 kV Customer Connection

**Need Number:** ATSI-2024-044  
**Process Stage:** Submission of Supplemental Projects for Inclusion in the Local Plan  
**Previously Presented** Need Meeting – 06/14/2024  
 Solution Meeting – 07/19/2024

**Supplemental Project Driver(s):**  
 Customer Service

**Specific Assumption Reference(s):**  
 New customer connection request will be evaluated per FirstEnergy’s “Requirements for Transmission Connected Facilities” document and “Transmission Planning Criteria” document.

**Problem Statement**  
 New Customer Connection – A retail customer has requested a new 138 kV delivery point in the East Springfield area. The anticipated load of the new customer connection is 200 MVA.

**Forecasted In-Service Date:**  
 September 25, 2026

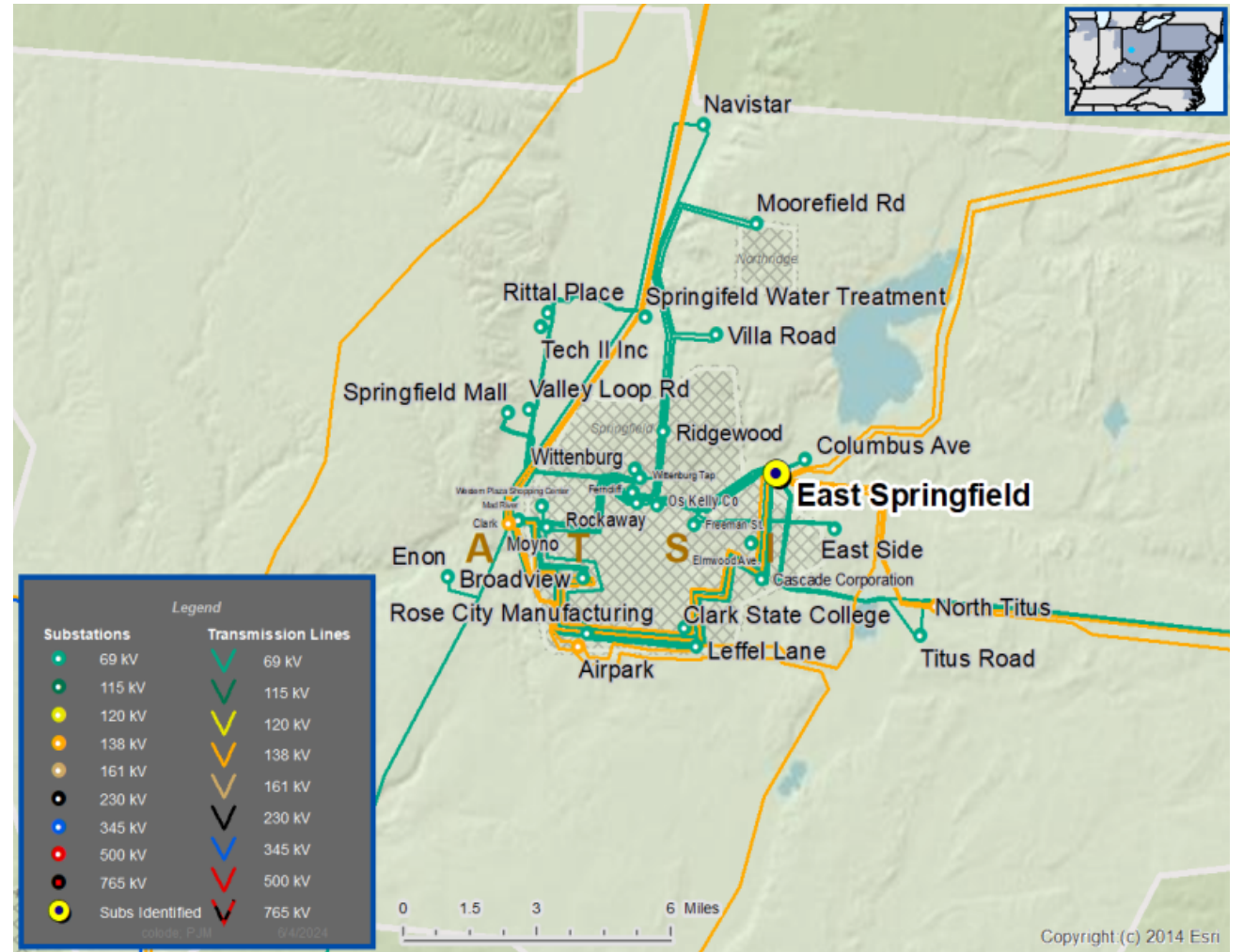



# ATSI Transmission Zone M-3 Process East Springfield 138 kV Customer Connection

**Need Number:** ATSI-2024-044  
**Process Stage:** Submission of Supplemental Projects for Inclusion in the Local Plan

**Selected Solution:**

**Phase 1: 138 kV Transmission Line Tap**

- Install two main-line SCADA controlled switches
- Install one tap-line SCADA controlled switch
- Construct approximately 0.1 miles of 138 kV line extension.
- Adjust relay settings at East Springfield and North Titus substations
- Install revenue metering

**Estimated Project Cost:** \$2.47M  
**Projected In-Service:** 3/1/2025  
**Supplemental Project ID:** s3524.1

## Phase 1: 138 kV Transmission Line Tap

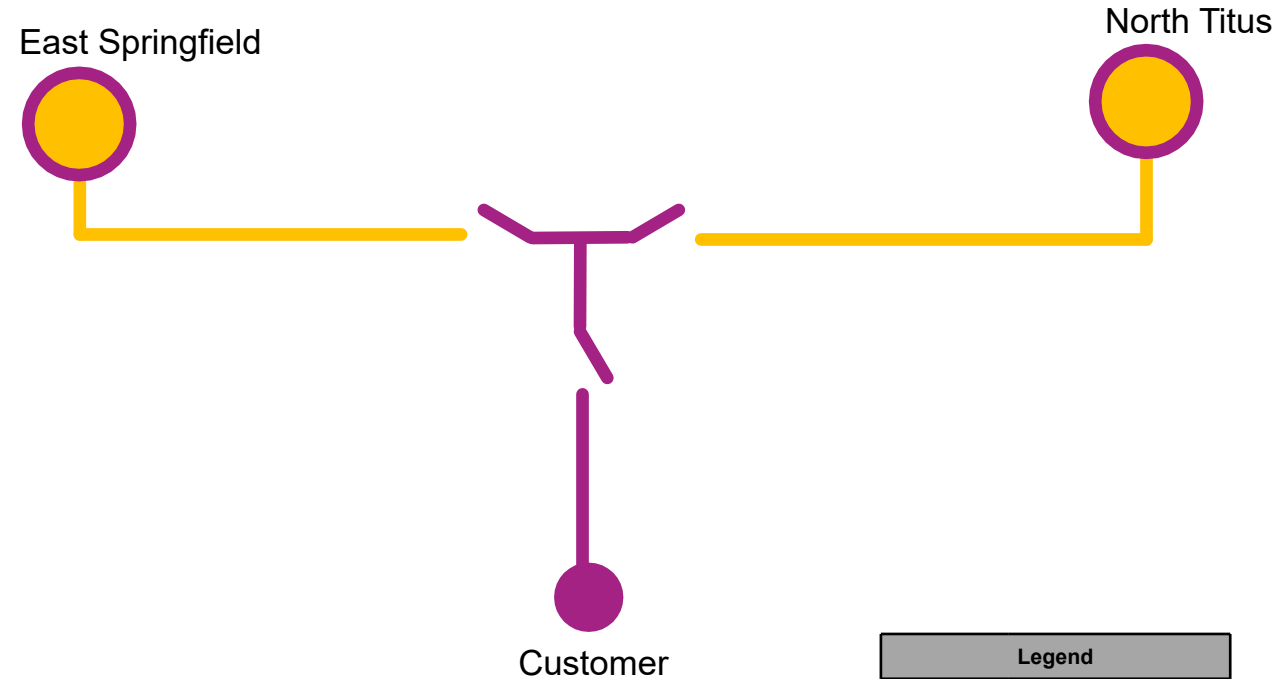

Legend	
500 kV	
345 kV	
138 kV	
69 kV	
34.5 kV	
23 kV	
New	

Continued on next slide...



# ATSI Transmission Zone M-3 Process Galion – Ontario 138 kV Line Customer Connection

**Need Number:** ATSI-2024-045  
**Process Stage:** Submission of Supplemental Projects for Inclusion in the Local Plan  
**Previously Presented:** Need Meeting – 06/14/2024  
 Solution Meeting – 07/19/2024

**Supplemental Project Driver(s):**  
 Customer Service

**Specific Assumption Reference(s):**  
 New customer connection request will be evaluated per FirstEnergy’s “Requirements for Transmission Connected Facilities” document and “Transmission Planning Criteria” document.

**Problem Statement**  
 New Customer Connection – A retail customer has requested a new 138 kV delivery point near the Galion – Ontario 138 kV Line. The anticipated load of the new customer connection is 63 MVA. The request is approximately 1,000 feet from Ontario Substation.

**Forecasted In-Service Date:**  
 December 31, 2025

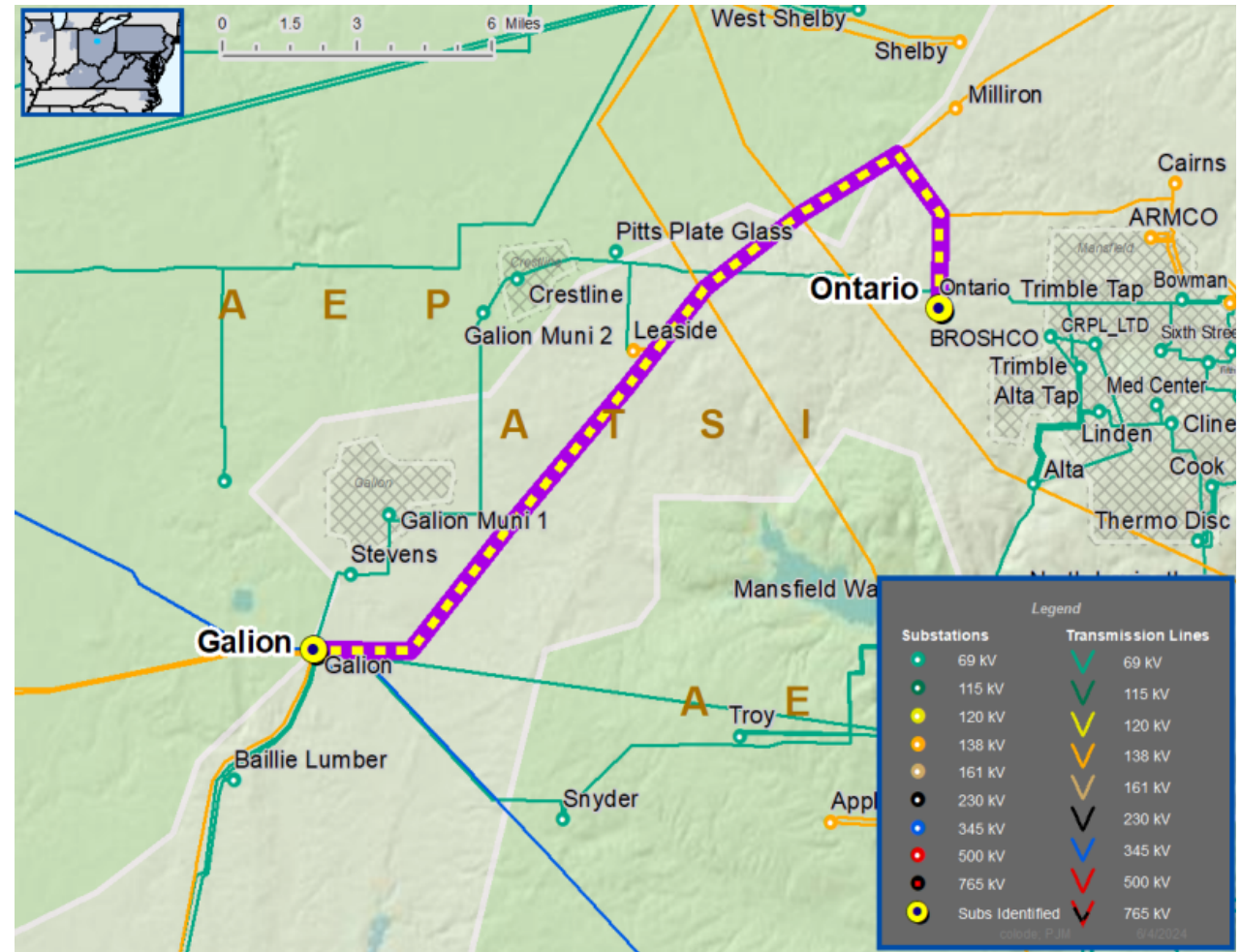



# ATSI Transmission Zone M-3 Process Galion – Ontario 138 kV Line Customer Connection

**Need Number:** ATSI-2024-045  
**Process Stage:** Solution Meeting – 07/19/2024

**Selected Solution:**

**138 kV Transmission Line Tap**

- Install two main-line SCADA controlled switches
- Install one tap-line SCADA controlled switch
- Construct 0.1 miles of 138 kV line extension.
- Adjust relay settings at Galion and Ontario substations
- Install revenue metering

**Estimated Project Cost:** \$1.04 M  
**Projected In-Service:** 7/14/2025  
**Supplemental Project ID:** s3525.1

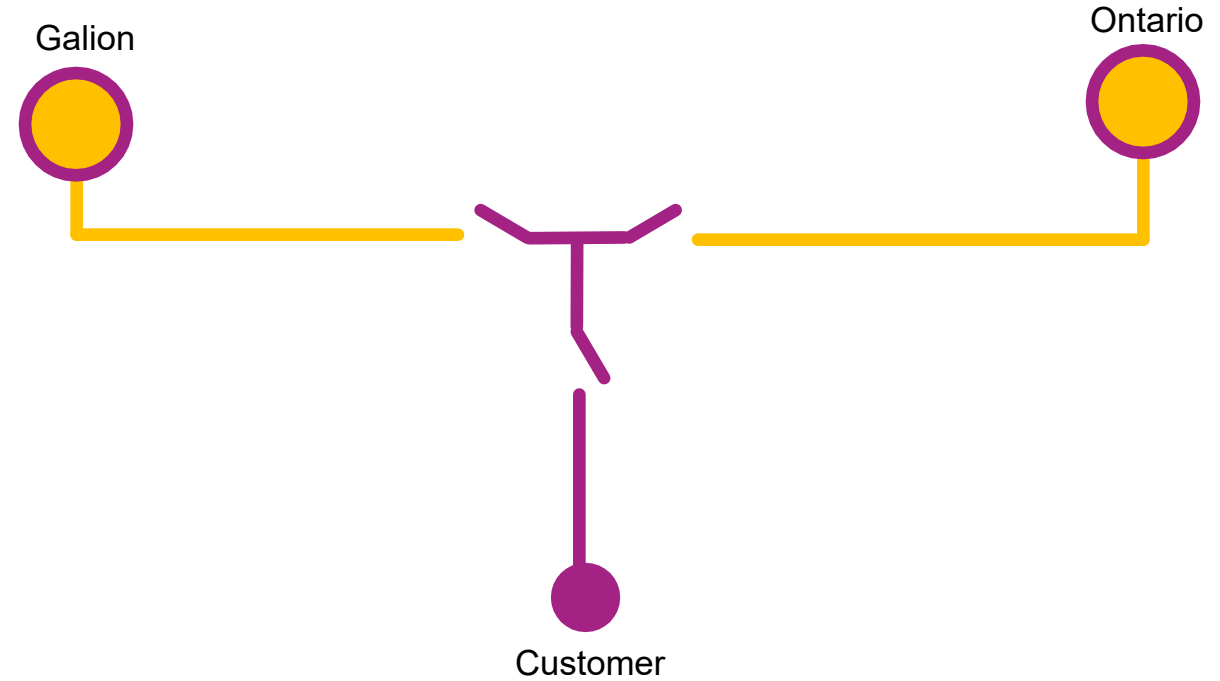

Legend	
500 kV	
345 kV	
138 kV	
69 kV	
34.5 kV	
23 kV	
New	



**Need Number:** AMPT-2023-005  
**Process Stage:** Submission of Supplemental Projects for Inclusion in the Local Plan  
**Previously Presented:** Need Meeting – 09/15/2023  
 Solution Meeting – 03/15/2024

**Supplemental Project Driver(s):**  
*Operational Flexibility & Efficiency, Customer Service*

**Specific Assumption Reference(s):**  
 AMPT Transmission Interconnection Document

**Problem Statement**  
 At the AMPT Sullivan 138/69 kV Substation (Shown as “Napoleon Muni”), a breaker failure (NERC P2-4 or P4-2 outage) of 138 kV CB “1”, 138 kV CB “4”, or 69kV CB “WBT” will interrupt both 138 kV sources from the substation, interrupting service to the entire Napoleon municipality (approximately 43 MW load at peak).

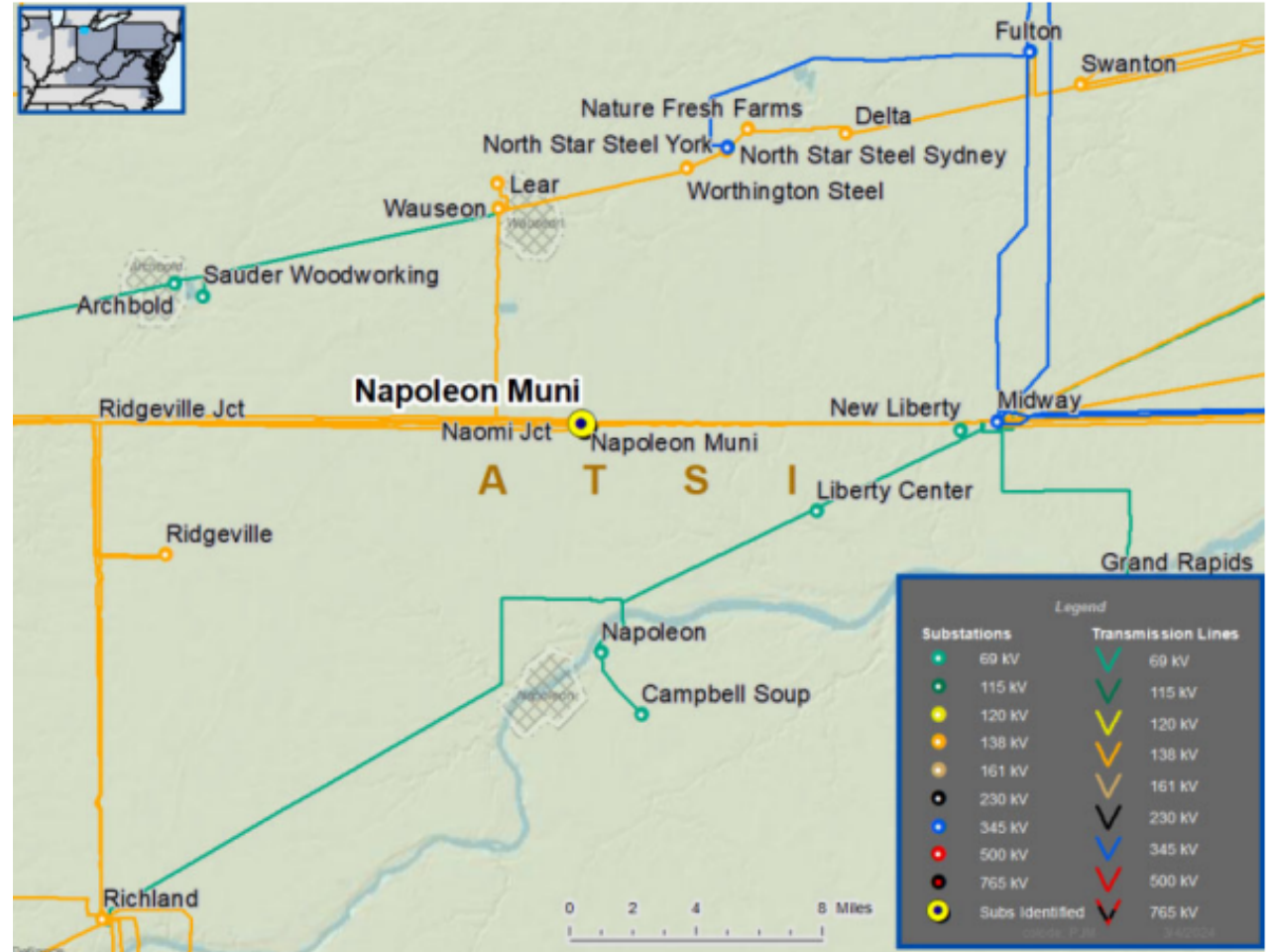

**Need Number:** AMPT-2023-005  
**Process Stage:** Submission of Supplemental Projects for Inclusion in the Local Plan

**Selected Solution:**

*FE Identified Scope*

- Convert the FE Napoleon 69 kV straight bus into a four-breaker ring bus
- Provide a line termination point for the AMPT 69 kV Line (Enterprise Substation exit).
- Upgrade the existing revenue metering equipment, including the CTs & PTs
- Revise relay settings at Napoleon, Richland, and Midway substations

**Transmission Ratings:**

- Napoleon (FE) – Enterprise (AMPT) 69 kV Line
  - Before the Project: N/A
  - After the Project: 111 / 131 / 125 / 159 MVA (SN/SE/WN/WE)

**Estimated Project Cost:** \$7.1 M  
**Projected In-Service:** 10/2/2026  
**Supplemental Project ID:** s3352.2

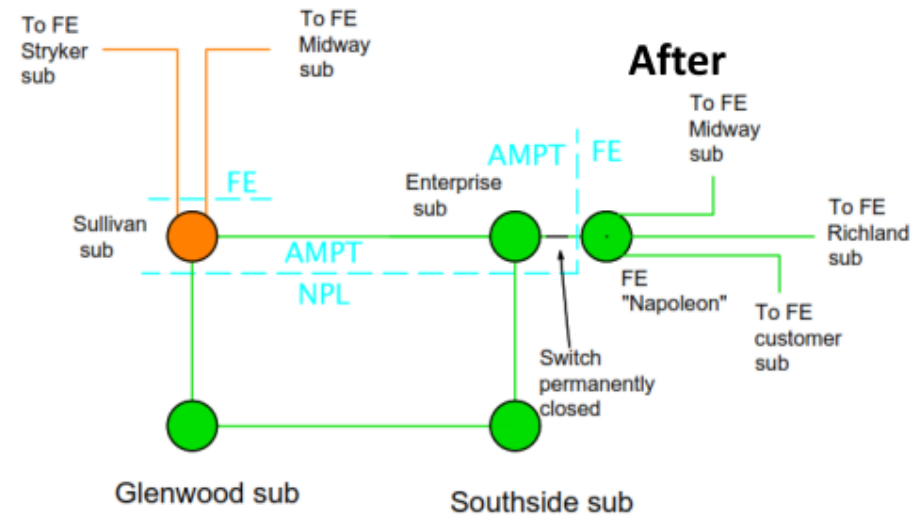
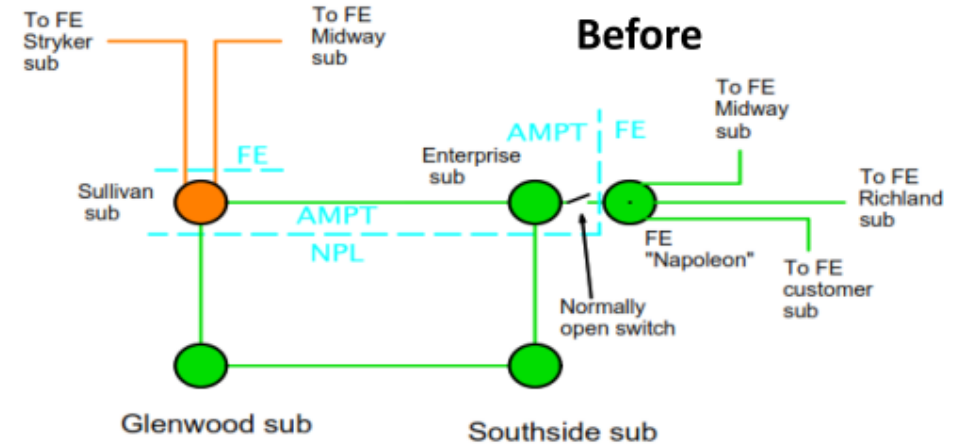

**Need Numbers:** ATSI-2023-028

**Process State:** Submission of Supplemental Projects for Inclusion in the Local Plan

**Previously Presented:** Need Meeting 11/17/2023

**Project Driver:**

*Equipment Material Condition, Performance and Risk*

**Specific Assumption Reference:**

System Performance Projects Global Factors

- Substation/line equipment limits
- Substation Condition Rebuild/Replacement
- Circuit breakers and other fault interrupting devices

**Problem Statement:**

- The 69 kV Oil Circuit Breaker B-31, B-39 and B-74, associated disconnect switches and protective relaying at Chamberlin Substation are aging with increasing maintenance concerns. The equipment is 43 years old.
- Transmission line ratings are limited by terminal equipment.

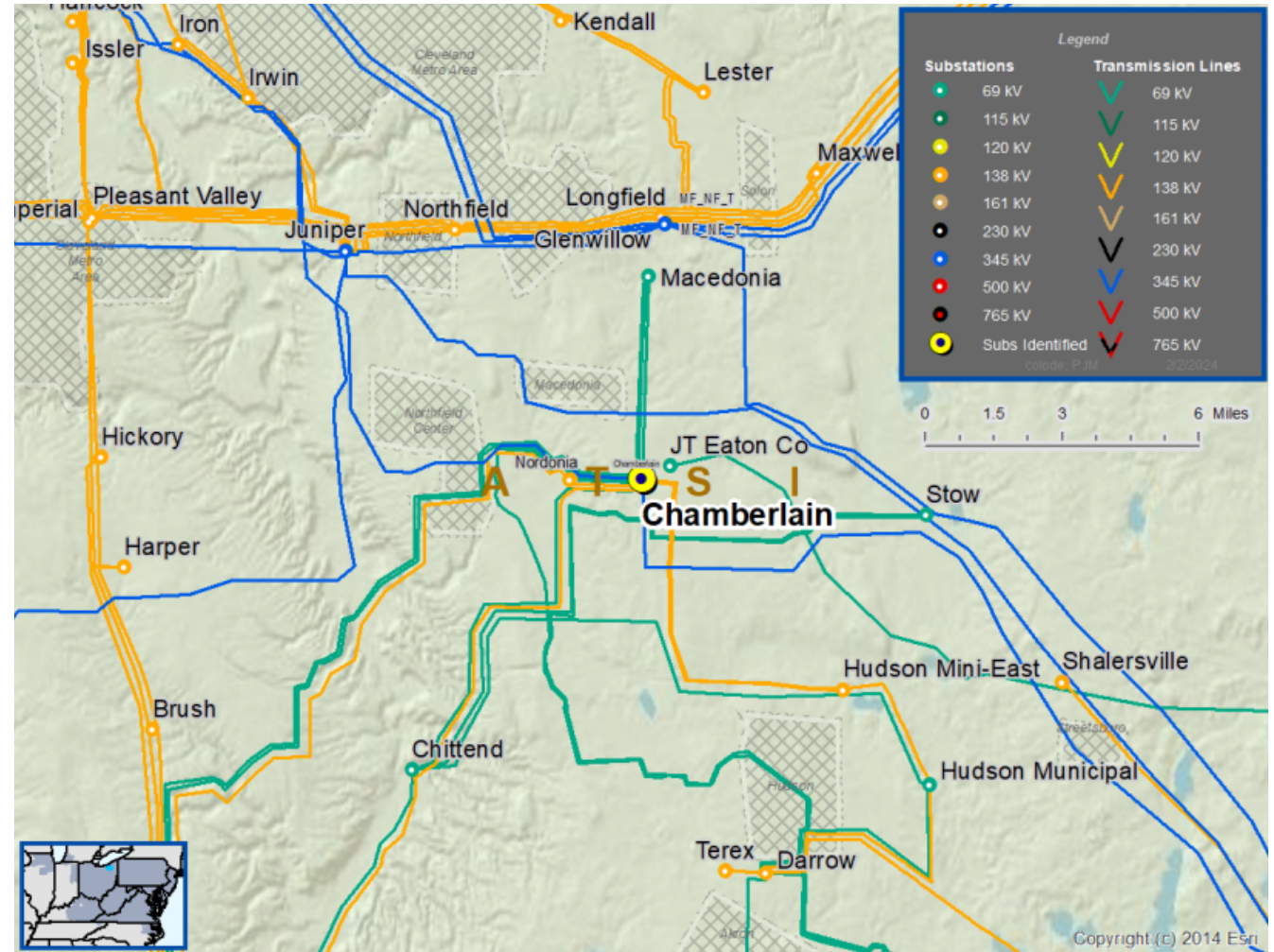

Continued on next slide...



ATSI Transmission Zone M-3 Process  
Chamberlin 69 kV Breakers

Need #	Transmission Line / Substation Locations	Existing Line Rating (SN / SE / WN / WE)	Existing Conductor Rating (SN / SE / WN / WE)
ATSI-2023-028	Chamberlin – Plastic Materials Tap 69 kV Line Section	82 / 103 / 108 / 124	110 / 134 / 127 / 162
	Chamberlin - Verizon Tap 69 kV Line Section	95 / 100 / 100 / 100	95 / 115 / 109 / 139
	Chamberlin No. 2 138/69 kV Transformer	163 / 163 / 163 / 163	164 / 174 / 199 / 208

**Need Numbers:** ATSI-2023-028

**Process State:** Submission of Supplemental Projects for Inclusion in the Local Plan

**Previously Presented:** Need Meeting 11/17/2023

**Proposed Solution:**

- At Chamberlin Substation, replace 69 kV circuit breakers B-31, B-39 and B-74, associated disconnect switches, limiting conductor and protective relaying for Plastic Materials, Verizon and No. 2 138/69 kV Transformer circuit.
- At Plastic Materials Tap, replace switch A-189.

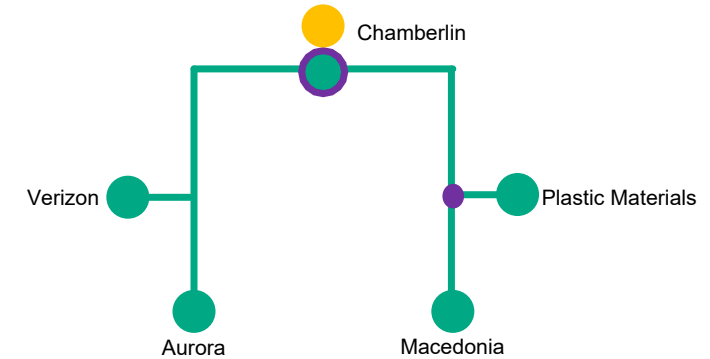

**Ratings:**

Need #	Transmission Line / Substation Locations	Existing Ratings (SN / SE / WN / WE)	New Ratings (SN / SE / WN / WE)
ATSI-2023-028	Chamberlin – Plastic Materials Tap 69 kV Line Section	82 / 103 / 108 / 124	110 / 134 / 127 / 162
	Chamberlin - Verizon Tap 69 kV Line Section	95 / 100 / 100 / 100	95 / 115 / 109 / 139
	Chamberlin No. 2 138/69 kV Transformer	163 / 163 / 163 / 163	164 / 174 / 199 / 208

Legend	
500 kV	
345 kV	
138 kV	
69 kV	
34.5 kV	
23 kV	
New	

**Alternatives Considered:**

- Maintain existing condition and risk of failure.

**Estimated Project Cost:** \$4.20M  
**Projected In-Service:** 12/31/2024  
**Status:** Engineering  
**Model:** 2023 RTEP Series for 2028  
**Supplemental Project ID:** s3374.1



# Revision History

1/4/2024 – V1 – Original Slides with AEP-2019-OH034

4/26/2024 – V2 – Added s3129.1, s3130.1, s3132.1, s3106.1, s3118.1, s3119.1, s3120.1, s3121.1, s3122.1, s3117.4, s3117.5, s3117.6, s3192.1, s3193.1

9/10/2024 – V3 - Added s3359.1, s3360.1, s3361.1, s3362.1, s3363.1, s3370.1, s3371.1, s3372.1 & s3373.1

9/23/2024 – V4 – Added s3453.1, s3454.1, s3455.1, s3456.1, s3467.1, s3468.1, s3469.1, s3494.1, s3495.1, s3496.1, s3497.1, s3498.1, s3499.1, s3500.1, s3521.1, s3522.1, s3523.1, s3524.1, s3525.1 & s3352.2

10/15/2024 – V5 – Added 3374.1