

Submission of Supplemental Projects for Inclusion in the Local Plan

AEP Local Plan - 2024

Need Number: AEP-2022-IM012

Process Stage: Submission of Supplemental Project for inclusion in the Local Plan 2/20/2024

Previously Presented:

Solutions Meeting 8/18/2023

Needs Meeting: 6/15/2022

Supplemental Project Driver: Customer Need

Specific Assumption Reference: AEP Guidelines for Transmission Owner Identified Needs (AEP Assumptions Slide 13)

Model: N/A

Problem Statement:

AEP I&M distribution has requested a new delivery point on the southern side of Fort Wayne to serve 13MW of load, transferred from McKinley station. The requested in service date is 6/1/2025

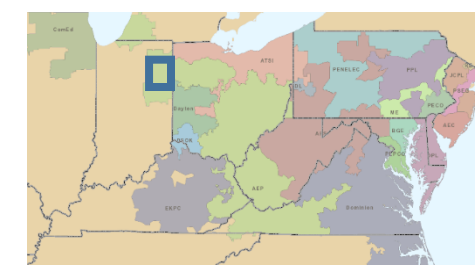
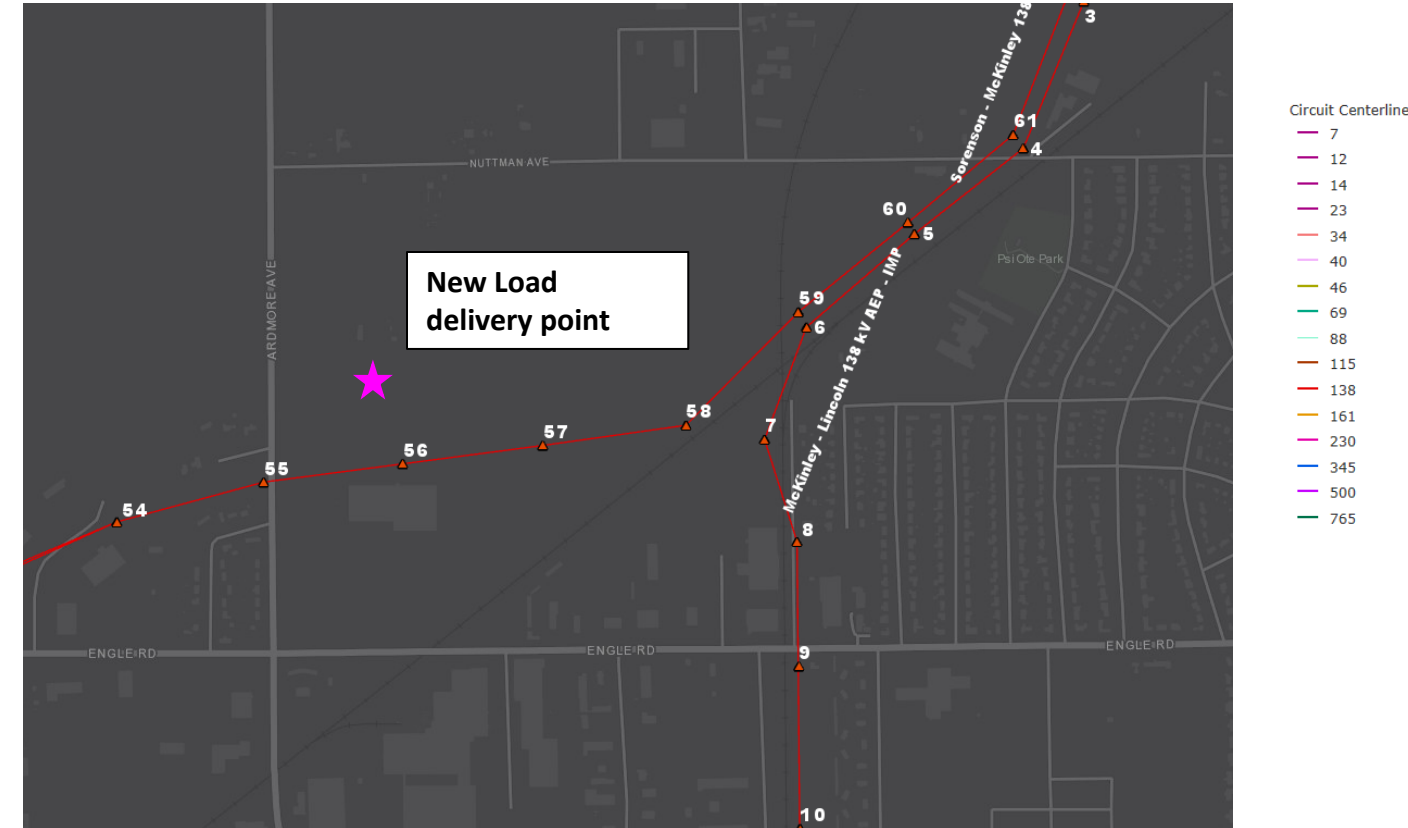



AEP Transmission Zone M-3 Process Kekionga Station

Need Number: AEP-2022-IM012

Process Stage: Submission of Supplemental Project for inclusion in the Local Plan 2/20/2024

Solution:

Install a 138kV/12kV distribution station named Kekionga on the Mckinley-Ellison Road 138kV line. Install 138kV line extension from Mckinley-Ellison 138kV line with fiber (~0.15 miles from the 138kV line), install 138kV bus with 2-138kV switches and 138kV MOAB.

Total Estimated Transmission Cost: \$4.4 M

Total Cost: \$4.4M

Projected In-Service: 11/12/2025

Supplemental Project ID: s3144.1

Project Status: Scoping

Existing

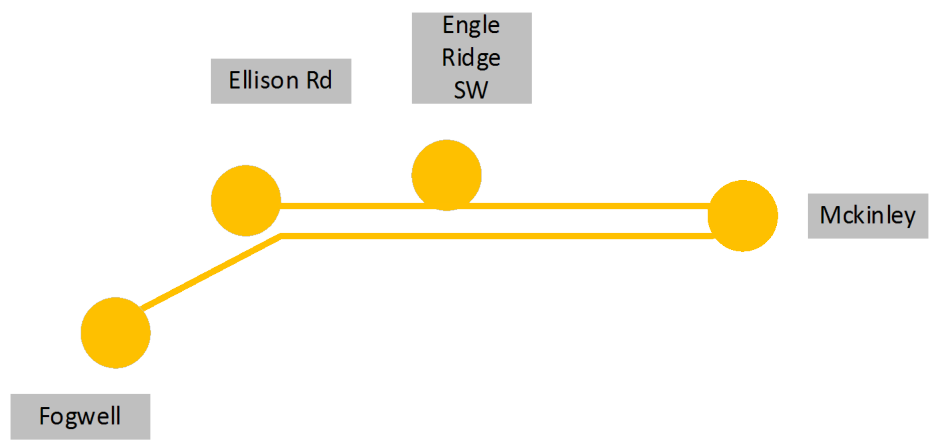

Proposed

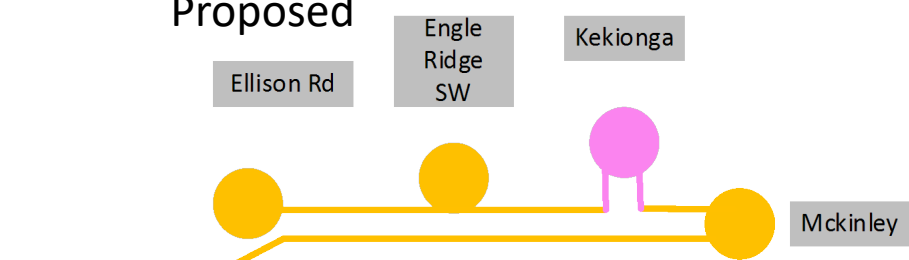

Legend	
500 kV	
345 kV	
138 kV	
69 kV	
34.5 kV	
23 kV	
New	

Need Number: AEP-2022-OH041

Process Stage: Submission of Supplemental Project for inclusion in the Local Plan 2/20/2024

Previously Presented:

Solution Meeting 08/18/2023

Need Meeting 09/16/2022

Project Driver:

Equipment Material/Condition/Performance/Risk; Operational Flexibility and Efficiency

Specific Assumption Reference:

AEP Guidelines for Transmission Owner Identified Needs (slides 13-14)

Problem Statement:

Equipment Material/Condition/Performance/Risk:

- The East Liverpool – Second Street 69kV circuit protection uses electromechanical relays and a legacy pilot wire communications channel. These relays have significant limitations with regard to spare part availability, SCADA functionality, and fault data collection and retention. In addition, these relays lack vendor support. Pilot wire cables are showing increased rates of failure and signal degradation across the AEP system.
- The 138kV tie-line to FirstEnergy uses electromechanical relays. The power-line-carrier equipment at East Liverpool was installed in 1962, presenting a failure risk. FE has indicated a future project is planned to upgrade relays on their side.
- The 138-69kV transformer protection system also utilizes outdated electromechanical relays.
- The 1962-vintage control house has various issues of concern: lead-based paints, asbestos, no air conditioning or exhaust fans, and small roof leaks.
- The station PT's are original to the station (1962) and are in poor condition with rusting. The AC station service system is in poor condition and uses a corner-ground connection which is a safety concern.
- There is a broken 69kV hook-stick disconnect switch needing replaced.

AEP Transmission Zone M-3 Process East Liverpool, Ohio

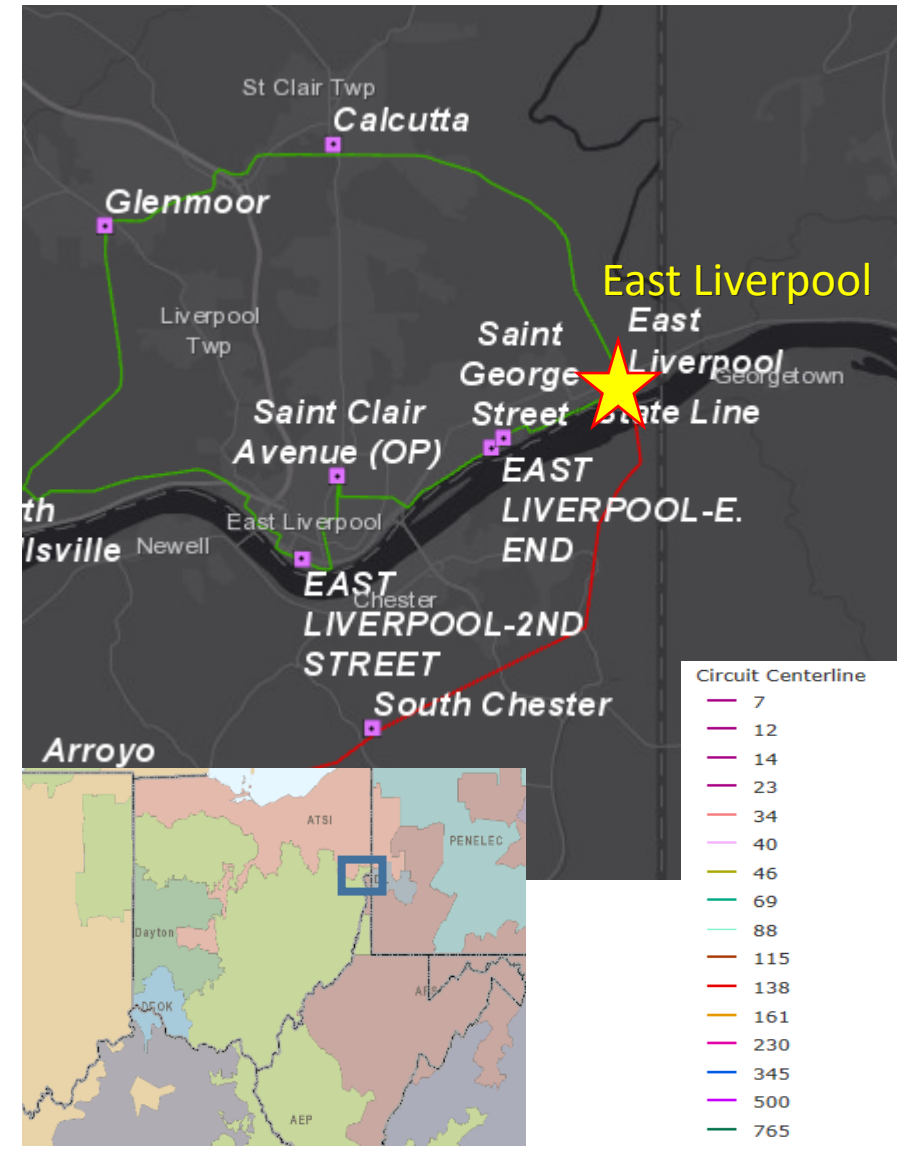

Need Number: AEP-2022-OH041

Process Stage: Submission of Supplemental Project for inclusion in the Local Plan 2/20/2024

Previously Presented:

Solution Meeting 08/18/2023

Need Meeting 09/16/2022

Project Driver:

Equipment Material/Condition/Performance/Risk; Operational Flexibility and Efficiency

Specific Assumption Reference:

AEP Guidelines for Transmission Owner Identified Needs (slides 13-14)

Problem Statement:

Operational Flexibility and Efficiency:

- The 138-69kV transformer lacks a high-side fault-interrupting device and only has a MOAB/ground-switch scheme. This requires remote-end fault clearing at FirstEnergy’s Wylie Ridge and Arroyo 138kV stations (3-terminal source). This remote-end fault clearing zone also drops FE’s South Chester station and distribution customers in the process.
- Due to the lack of circuit breakers at the station, there are 3 overlapping zones of protection: 69kV bus, 138-69kV transformer, and 138kV line. These dissimilar zones of protection can cause over tripping and mis-operations.

AEP Transmission Zone M-3 Process East Liverpool, Ohio

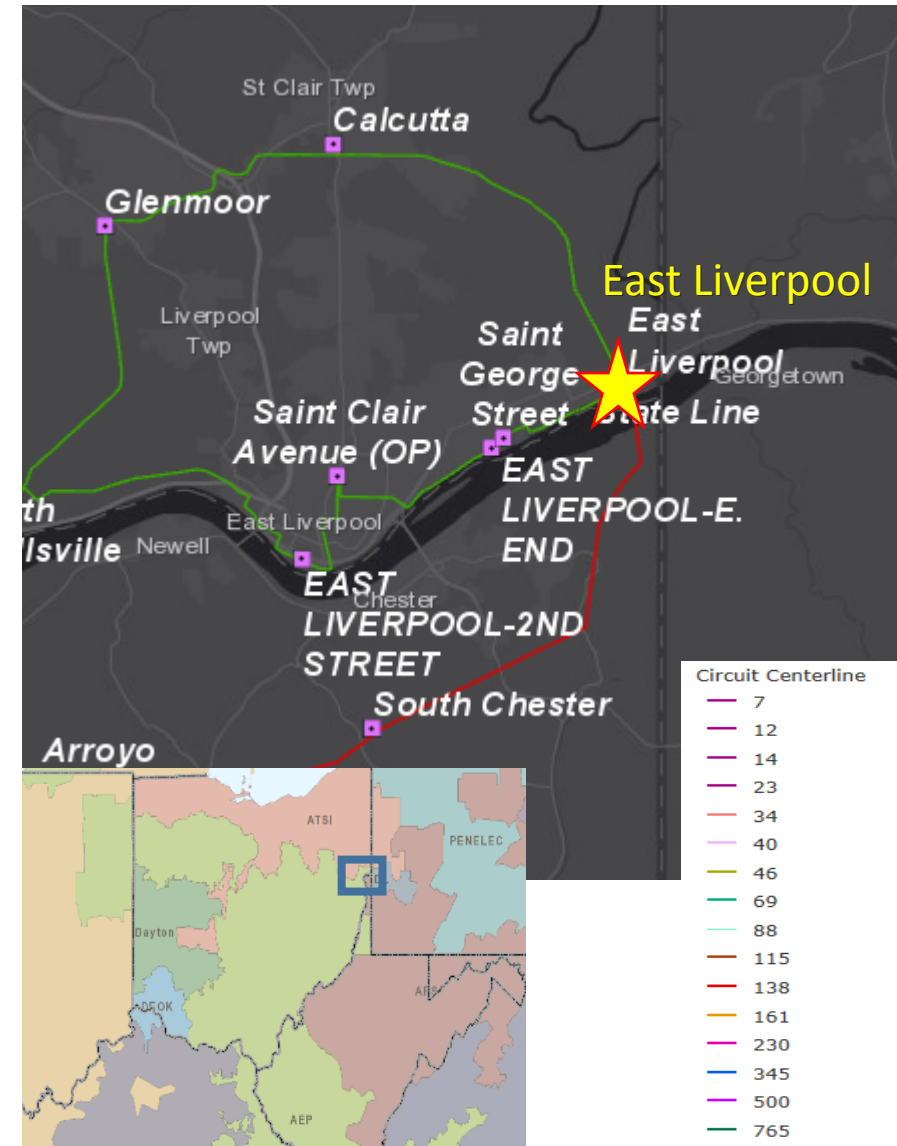

Need Number: AEP-2022-OH041

Process Stage: Submission of Supplemental Project for inclusion in the Local Plan 2/20/2024

Solution:

- At East Liverpool station, replace the 138kV MOAB/ground switch system with a circuit breaker and new relays. Install a 69kV breaker on the low side of the 138-69kV transformer. Upgrade tie-line metering, relays, and expand SCADA functionality at the station. Replace the control house with a new prefabricated control building. \$3.0 Million **(s3145.1)**
- At the 69kV remote end station of Second Street, replace the electromechanical relays and pilot wire communications with microprocessor-based relays, to coordinate with East Liverpool. Install new 69kV CCVT's. \$0.3 Million **(s3145.2)**

Total Transmission Cost: \$3.3 Million

Projected In-Service: 5/1/2025

Supplemental Project ID: s3145.1-.2

Project Status: Scoping

Model: 2027 PJM RTEP Models

Legend	
500 kV	
345 kV	
138 kV	
69 kV	
34.5 kV	
23 kV	
New	

AEP Transmission Zone M-3 Process East Liverpool Station Upgrade

Existing:

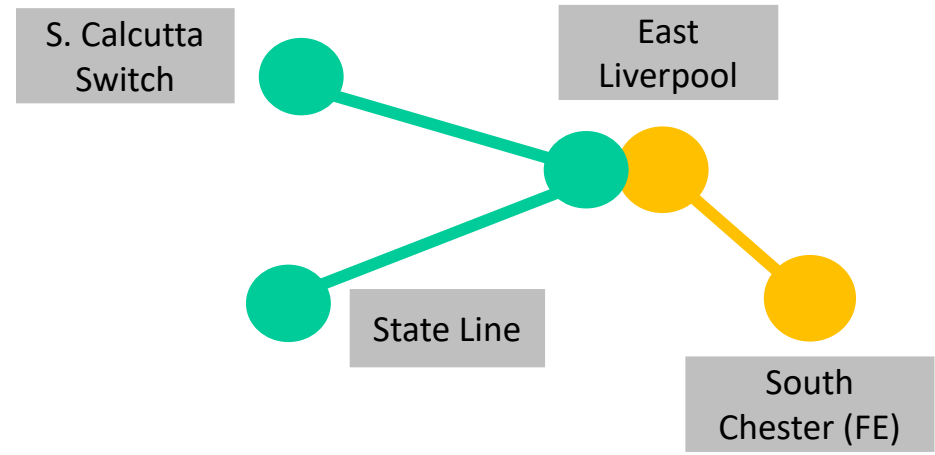

Proposed:

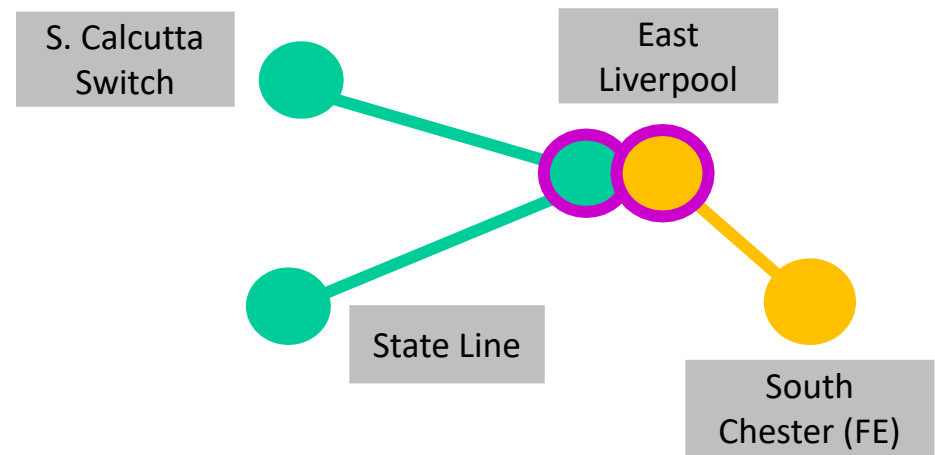



BOUNDLESS ENERGY™

AEP Transmission Zone M-3 Process Wayne County, WV

Need Number: AEP-2023-AP005

Process Stage: Submission of Supplemental Project for inclusion in the Local Plan 2/20/2024

Previously Presented:

Solutions Meeting 8/18/2023

Needs Meeting 2/17/2023

Supplemental Project Driver: Customer Service and Operational Flexibility

Specific Assumption References: AEP Connection Requirements for the AEP Transmission System (AEP Assumptions Slide 12, 14)

Problem Statement:

Miller Switch Station, on the existing Leach – South Neal 69 kV line currently serves two separate customers off of a 0.5 mile radial 69 kV line. Total existing load served off this line is approximately 8 MW. Radial lines complicate maintenance activities due to the customers needing to be taken out of service in order to perform any work on the line.

TC Energy – Kenova has requested a 12 MW load increase at their existing Columbia Gas Station delivery point served off the radial from Miller Switch. This load is currently served from a hard tap on the radial extension, which greatly complicates restoration activities and extend outages. This configuration also affects the customer served at the Markwest station as they are also fed from the radial line.

Summer projected load: 16 MVA

Winter projected load: 16 MVA.

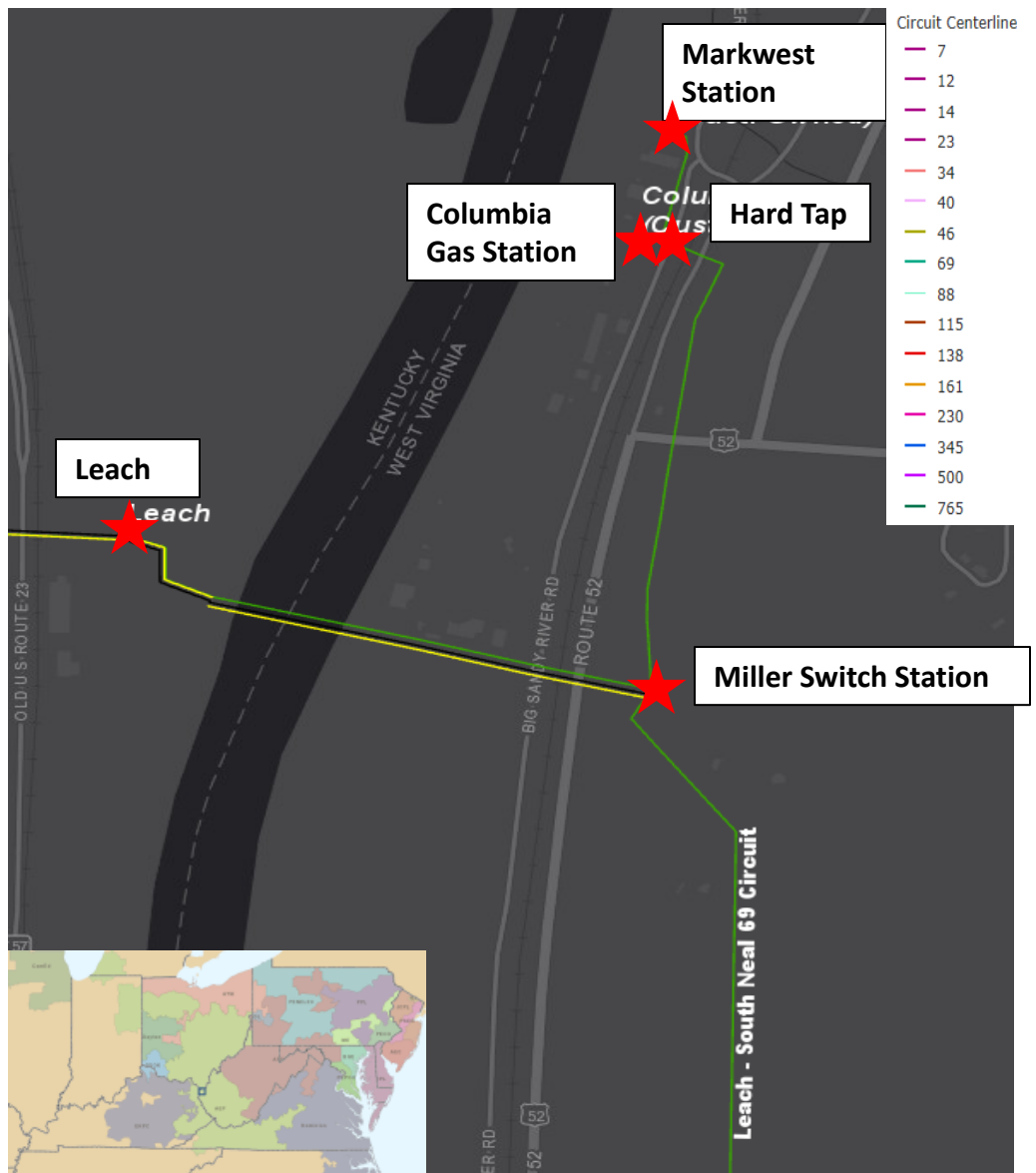

Need Number: AEP-2023-AP005

Process Stage: Submission of Supplemental Project for inclusion in the Local Plan 2/20/2024

Solution:

Cut in/out of the existing South Neal – Leach 69 kV line, install a new double circuit 69 kV 0.6 mile line which will replace the existing 69 kV radial tap line currently serving both Markwest and Columbia Gas. Build single circuit less than 0.1 mile back to Markwest from Sweet Run S.S. and to Columbia Gas from Pipeline S.S. Miller Switch Station will also be removed upon completion of the new line construction. Estimated Trans. Cost: \$5.6M **(s3146.1)**

Replace existing hard tap serving Columbia gas with a new 3-way phase over phase switch. Estimated Trans. Cost: 1.1M **(s3146.2)**

Install a new 3-way phase over phase switch on the new line outside of the existing Markwest delivery point. Estimated Trans. Cost: 1.1M **(s3146.3)**

Total Estimated Transmission Cost: \$7.8M

Projected In-Service: 6/1/2024

Supplemental Project ID: s3146.1-.3

Project Status: Scoping

Model: 2028 RTEP

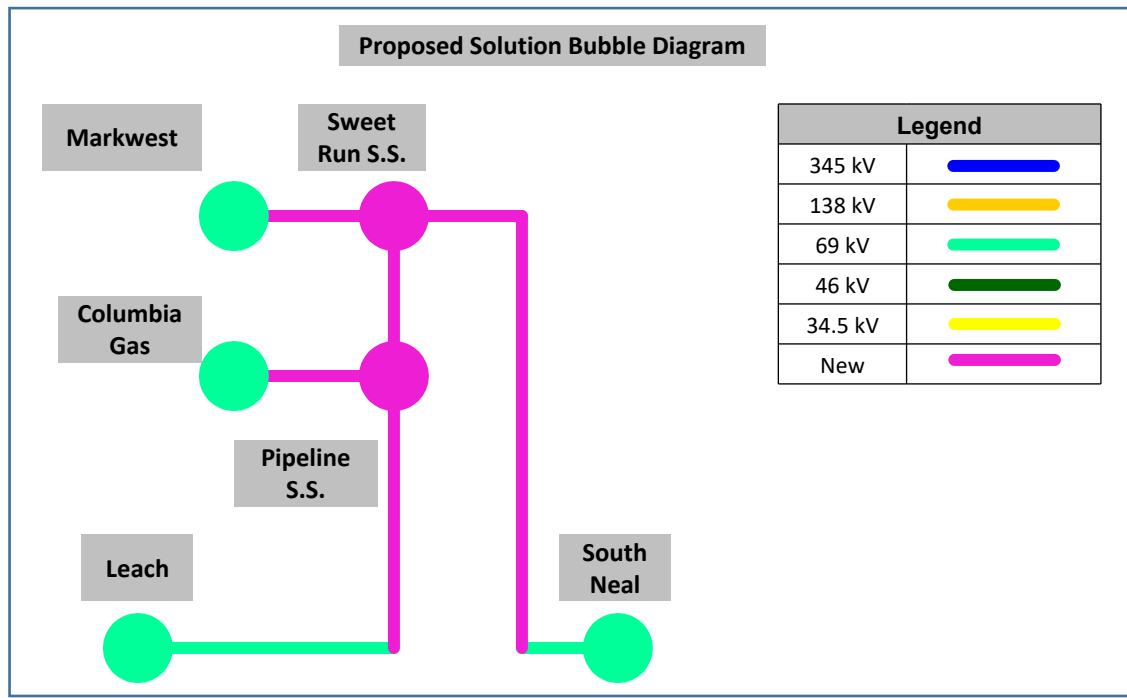
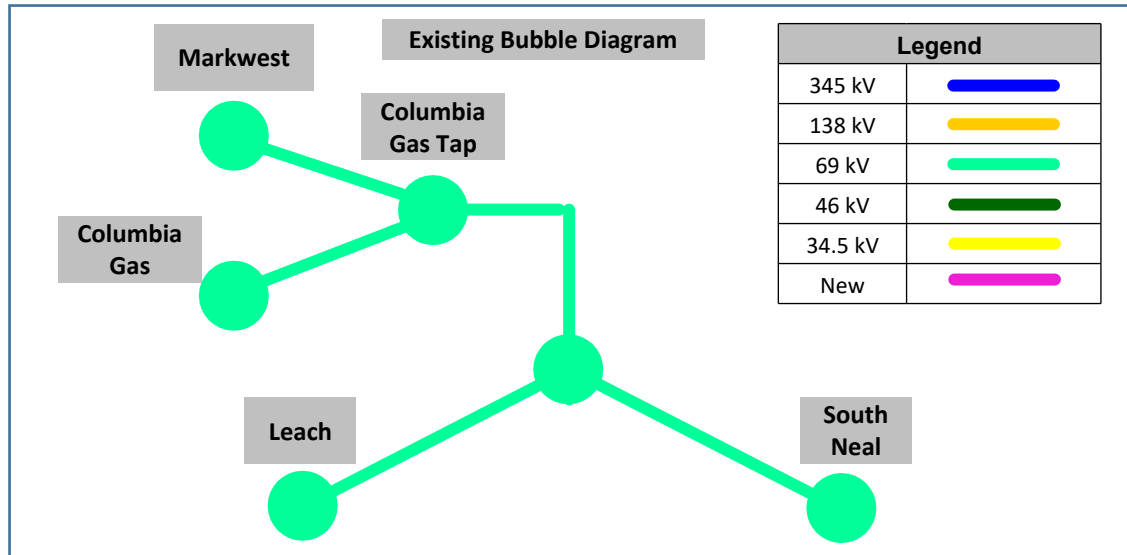

Need Number: AEP-2022-AP007

Process Stage: Submission of Supplemental Project for inclusion in the Local Plan 2/20/2024

Previously Presented:

Solutions Meeting 8/18/2023

Need Meeting 2/18/2022

Supplemental Project Driver: Equipment Condition/Performance/Risk

Specific Assumption Reference:

AEP Guidelines for Transmission Owner Identified Needs (AEP Assumptions Slide 13)

Problem Statement:

Barrenshe Station:

- All 15 relays at Barrenshe station are in need of replacement. There are 11 electromechanical relays which have significant limitations with regards to fault data collection and retention. These relays lack vendor support and have little to no access to spare parts. Also, the remaining 4 microprocessor relays were commissioned from 2006-2007 and are at the end of their useful life.
- The station bay was constructed using wood poles that were installed in 1953. The poles are very rotten and there is concern that any type of stress on the poles could cause the station to fail completely. The poles closest to the transformer are leaning and have twisted the bus.
- In 1977, flood waters were over 3/4 up the control cabinet. There has been repeated wash out in the rear of the station causing the fence post foundations to wash away. The station lies in the 100 year flood plain between mountainous terrain and highway 194 making expansion at the existing site extremely difficult.
- 69 kV MOAB W is 1973 vintage and needs replaced due to wear and lack of available parts.

AEP Transmission Zone M-3 Process Pike County, Kentucky

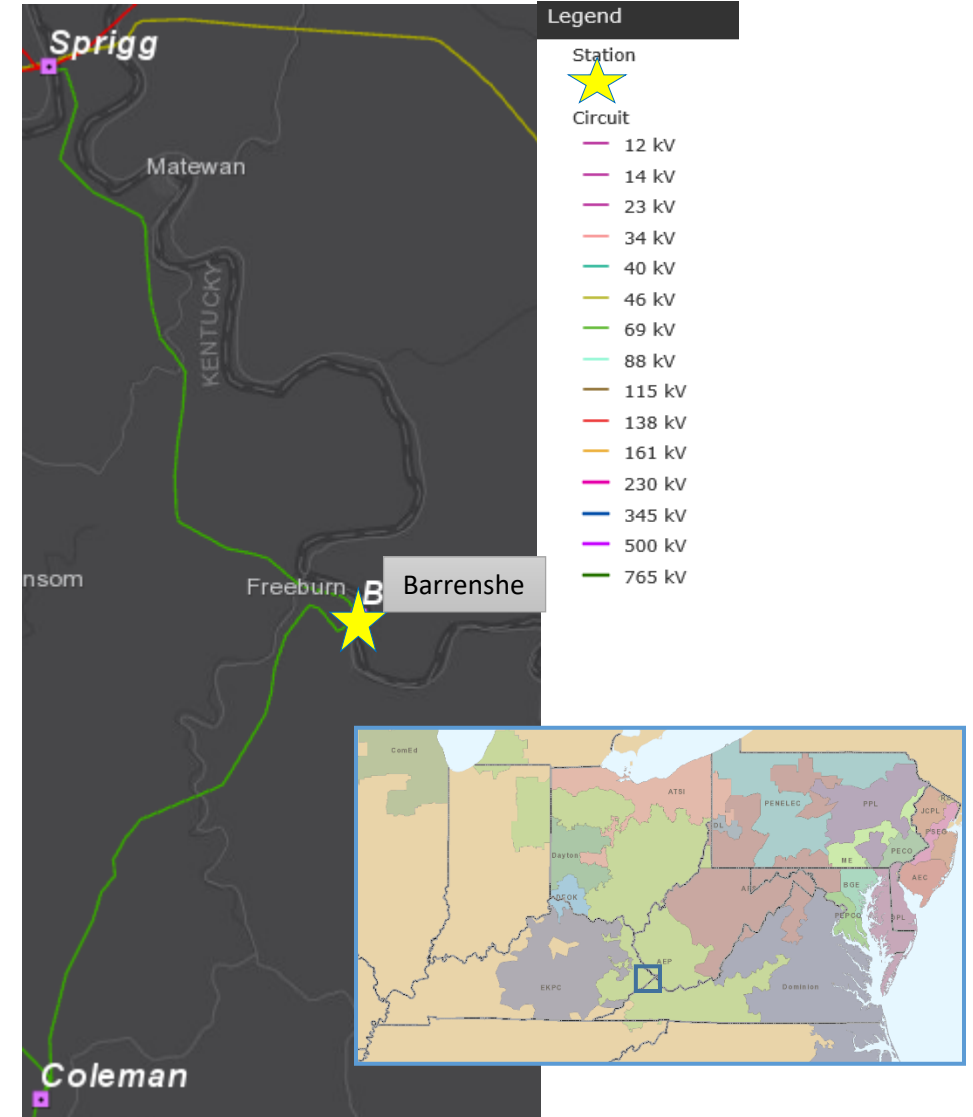

Need Number: AEP-2022-AP008

Process Stage: Submission of Supplemental Project for inclusion in the Local Plan 2/20/2024

Previously Presented:

Solutions Meeting 8/18/2023

Need Meeting 2/18/2022

Supplemental Project Driver: Equipment Condition/Performance/Risk

Specific Assumption Reference:

AEP Guidelines for Transmission Owner Identified Needs (AEP Assumptions Slide 13)

Problem Statement:

Coleman – Sprigg 69 kV:

Original Install Date: 1926

Length of Line: ~13 mi

Total structure count: 101

Original Line Construction Type: Wood

Conductor Type: 2/0 Copper, 176,900 ACSR, 556,500 ACSR, 795,000 ACSR

Momentary/Permanent Outages: 11 Momentary and 10 Permanent

Line Conditions:

- The 10 permanent outages caused 2.6M minutes of interruption for distribution customers
- The line structures fail to meet 2017 NESC Grade B loading criteria, current AEP structural strength requirements, and the current ASCE structural strength requirements.
- Currently, there are 44 structures with at least one open condition, which relates to 43% of the structures on the circuit specifically affecting the crossarm, knee/ vee brace, or pole including rot, damaged, insect damage, and bowed conditions.
- 39 of 101 (39%) structures are 1920s vintage
- 53 of 101 (52%) are 1970s vintage. The Barrenshe – Coleman segment was rebuilt in the early 1970s. On the Sprigg – Barrenshe segment, 17 structures were also rebuilt in the 1970s. These 1970s structures are also showing signs of pole cracking, weathering, rot, and woodpecker damage. The crossarms and braces show signs of mold as well as signs of rot, cracking, splitting, bowing, and weathering.

AEP Transmission Zone M-3 Process Pike County, Kentucky

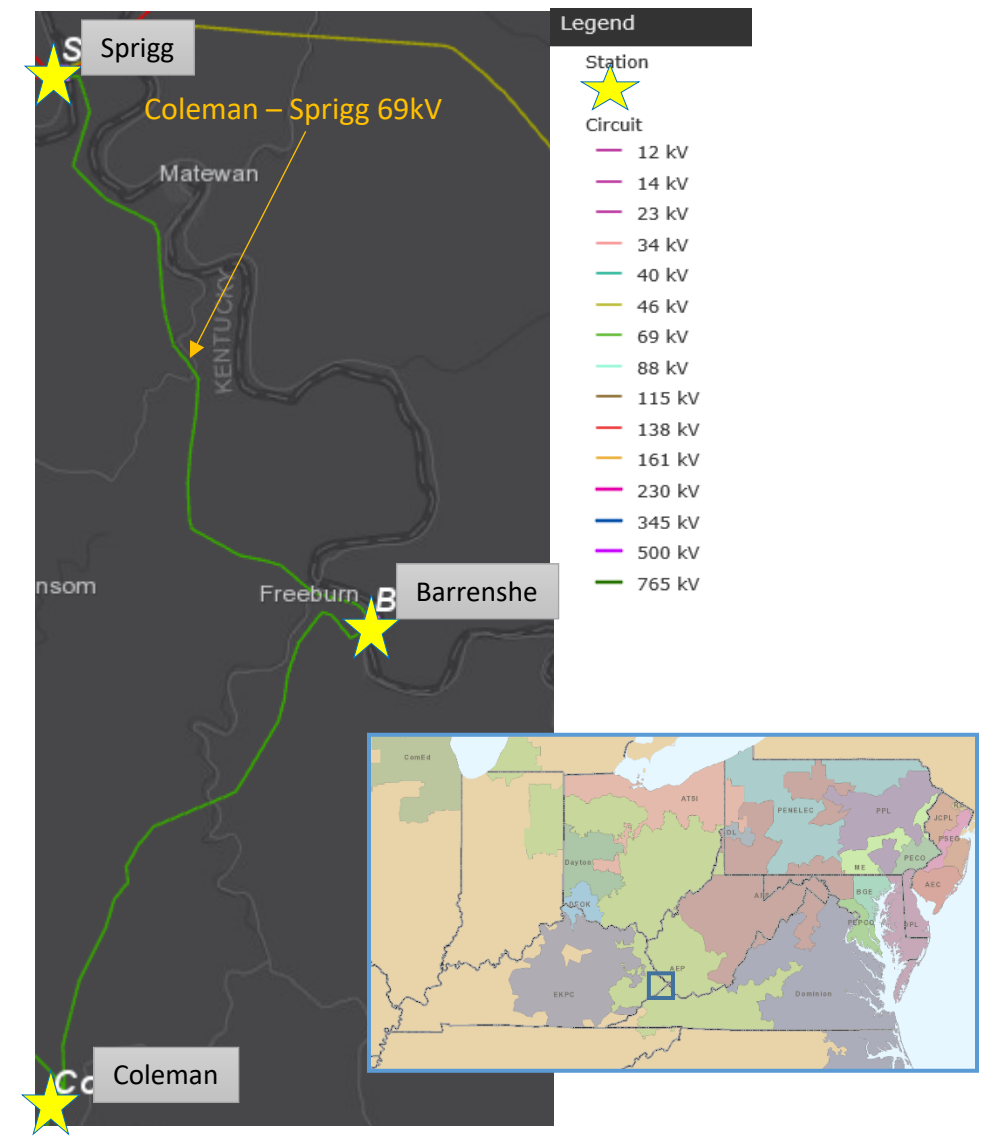

Need Number: AEP-2022-AP008

Process Stage: Submission of Supplemental Project for inclusion in the Local Plan 2/20/2024

Previously Presented:

Solutions Meeting 8/18/2023

Need Meeting 2/18/2022

Supplemental Project Driver: Equipment Condition/Performance/Risk

Specific Assumption Reference:

AEP Guidelines for Transmission Owner Identified Needs (AEP Assumptions Slide 13)

Coleman – Sprigg 69 kV Continued:

Line Conditions Cont'd:

- The 4-bell porcelain insulators on the line do not meet current AEP standards for CIFO and minimum leakage distance requirements.
- There is no shielding present on the Sprigg – Barrenshe segment, which is inadequate for AEP's current shielding requirements and leads to poor lightning performance for the circuit.
- The butt wrap grounding is inadequate per current AEP Standards and causes poor lightning performance. The current grounding system, poor shielding angle, and the electrical strength of the insulators do not meet current AEP and industry accepted criteria, making the line susceptible momentary and permanent outages, affecting customer reliability.
 - The inadequate grounding limits the available path to ground during any type of line fault, increasing the intensity the conductor and related hardware have to withstand during the fault. The reduced electrical strength of the insulators could lead to electrical damage to structures and hardware during a fault if the insulator were to fail from elevated electrical stresses.
- The line serves a peak load of 12.5 MVA at Barrenshe station.

AEP Transmission Zone M-3 Process

Pike County, Kentucky

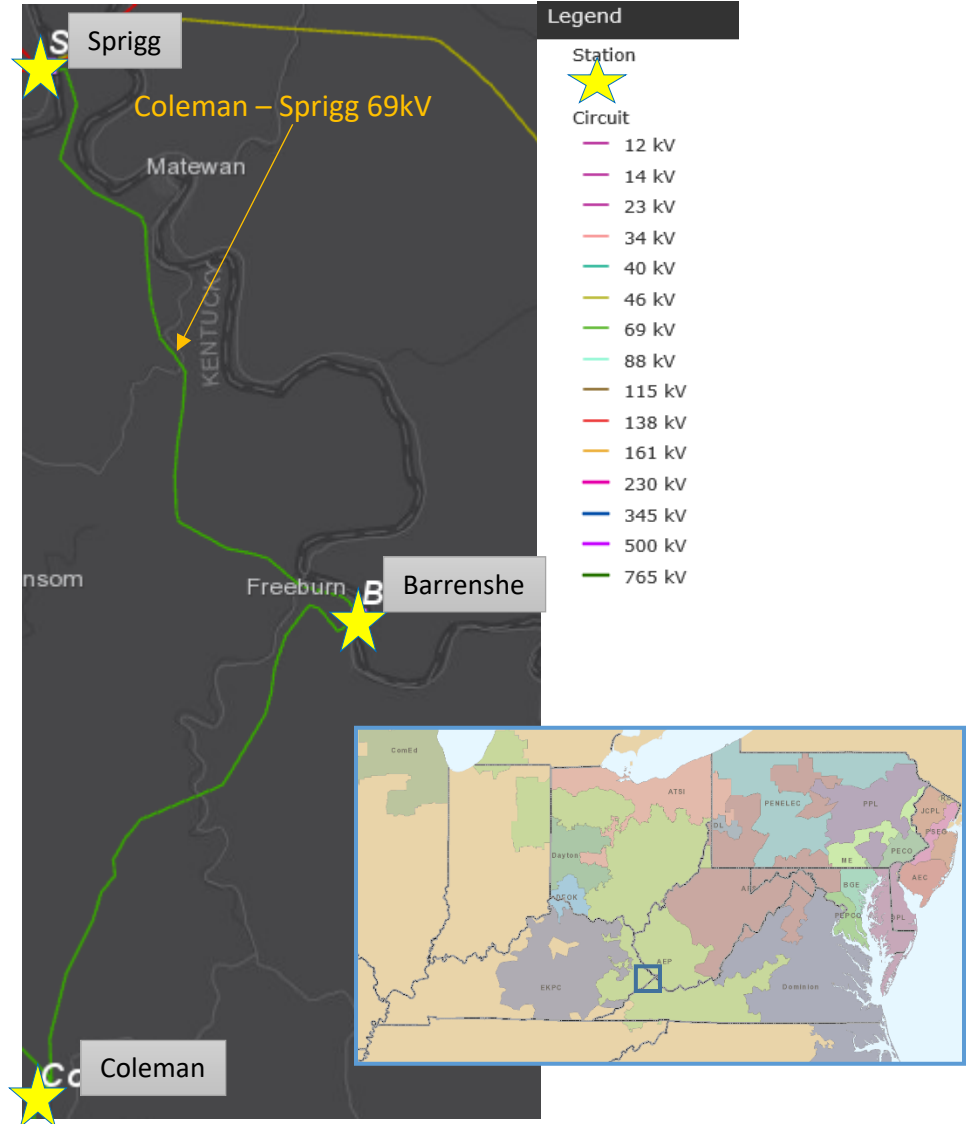



BOUNDLESS ENERGY™

Need Number: AEP-2022-AP009

Process Stage: Submission of Supplemental Project for inclusion in the Local Plan 2/20/2024

Previously Presented:

Solutions Meeting 8/18/2023

Need Meeting 2/18/2022

Supplemental Project Driver: Equipment Condition/Performance/Risk

Specific Assumption Reference:

AEP Guidelines for Transmission Owner Identified Needs (AEP Assumptions Slide 13)

Problem Statement:

Sprigg – Wharncliffe 46 kV:

Original Install Date (Age): 1929

Length of Line: ~18 mi

Total structure count: 120

Original Line Construction Type: Wood

Conductor Type: 1/0 Copper, 176,900 ACSR, 336,400 ACSR, 556,500 ACSR

Momentary/Permanent Outages: 27 Momentary and 10 Permanent

Line Conditions:

- The 10 permanent outages caused 481k minutes of interruption for distribution customers
- The line structures fail to meet 2017 NESC Grade B loading criteria, current AEP structural strength requirements, and the current ASCE structural strength requirements.
- Currently, there are 39 structures with at least one open condition, which relates to 33% of the structures on the circuit specifically affecting the crossarm, knee/ vee brace, or pole including rot, damaged, insect damage, woodpecker holes, and bowed conditions.
- 32 of the 120 structures are 1930s vintage or older accounting for 27% of the structures. Another 33 of the 120 structures are split almost evenly between 1940s, 50s, and 60s vintage, accounting for 28% of the structures. An additional 22 of 120 structures are spread between the 1970s and 90s (18%). The described structures, including 11% more are all wood structures, with only 16% of the line made up of steel structures.

AEP Transmission Zone M-3 Process Pike County, Kentucky and Mingo County, West Virginia

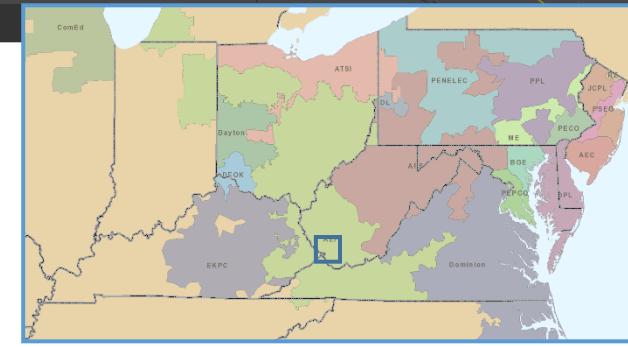
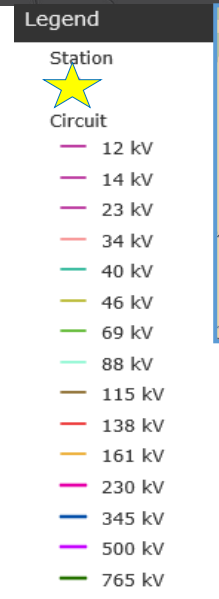

Need Number: AEP-2022-AP009

Process Stage: Submission of Supplemental Project for inclusion in the Local Plan 2/20/2024

Previously Presented:

Solutions Meeting 8/18/2023

Need Meeting 2/18/2022

Supplemental Project Driver: Equipment Condition/Performance/Risk

Specific Assumption Reference:

AEP Guidelines for Transmission Owner Identified Needs (AEP Assumptions Slide 13)

Sprigg – Wharncliffe 46 kV Continued:

Line Conditions Cont'd:

- The 4-bell porcelain insulators on the line do not meet current AEP standards for CIFO and minimum leakage distance requirements.
- The majority of the line has no static wire, making it inadequate for AEP current shielding angle requirements and results in poor lightening performance.
- The butt wrap grounding and typical shield angle is inadequate per current AEP Standards and can cause poor lightning performance. The current grounding system, poor shielding angle, and the electrical strength of the insulators do not meet current AEP and industry accepted criteria, making the line susceptible momentary and permanent outages, affecting customer reliability.
 - The inadequate grounding limits the available path to ground during any type of line fault, increasing the intensity the conductor and related hardware have to withstand during the fault. The reduced electrical strength of the insulators could lead to electrical damage to structures and hardware during a fault if the insulator were to fail from elevated electrical stresses.
 - The line serves a peak load of 6 MVA at Grapevine, Briar Mountain, and Bens Creek stations.

AEP Transmission Zone M-3 Process

Pike County, Kentucky and Mingo County, West Virginia

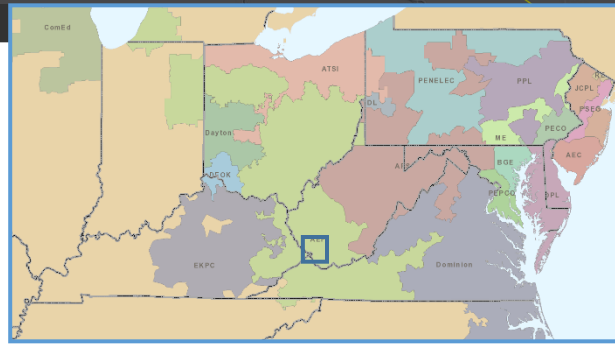
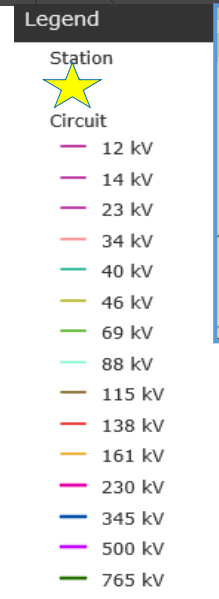



BOUNDLESS ENERGY™

Need Number: AEP-2022-AP010

Process Stage: Submission of Supplemental Project for inclusion in the Local Plan 2/20/2024

Previously Presented:

Solutions Meeting 8/18/2023

Need Meeting 2/18/2022

Supplemental Project Driver: Equipment Condition/Performance/Risk

Specific Assumption Reference:

AEP Guidelines for Transmission Owner Identified Needs (AEP Assumptions Slide 13)

Problem Statement:

Jim Branch – Wharnccliffe 46 kV:

Original Install Date (Age): 1925 and 1930

Length of Line: ~25 mi

Total structure count: 162

Original Line Construction Type: Wood

Conductor Type: 1/0 Copper, 2/0 Copper, #2 ACSR, 4/0 ACSR, 176,900 ACSR, 556,500 ACSR

Momentary/Permanent Outages: 29 Momentary and 20 Permanent

Line Conditions:

- The momentary outages were attributed to lightning (24), wind (3), relay mis-operation (1), unknown (1), and distribution (1) causes. The permanent outages attributed to vegetation contacts from outside the AEP ROW (12), lightning (4), pole failure (1), failed insulator (1), ice/snow (1), and relay mis-operation (1) causes. The large number of lightning caused outages is due to 65% of the circuit lacking shield wire.
- The permanent outages caused 2.62M minutes of interruption for 11,744 customers at Panther and Hardy substations.
- The line structures fail to meet 2017 NESC Grade B loading criteria, current AEP structural strength requirements, and the current ASCE structural strength requirements.
- 134 of the 162 structures are 1930s vintage or older accounting for 83% of the structures. These structures have conditions like top rot, Woodpecker damage, split top, heart rot, base rot, bowing, and corroded hardware.

AEP Transmission Zone M-3 Process Mingo and McDowell County, West Virginia

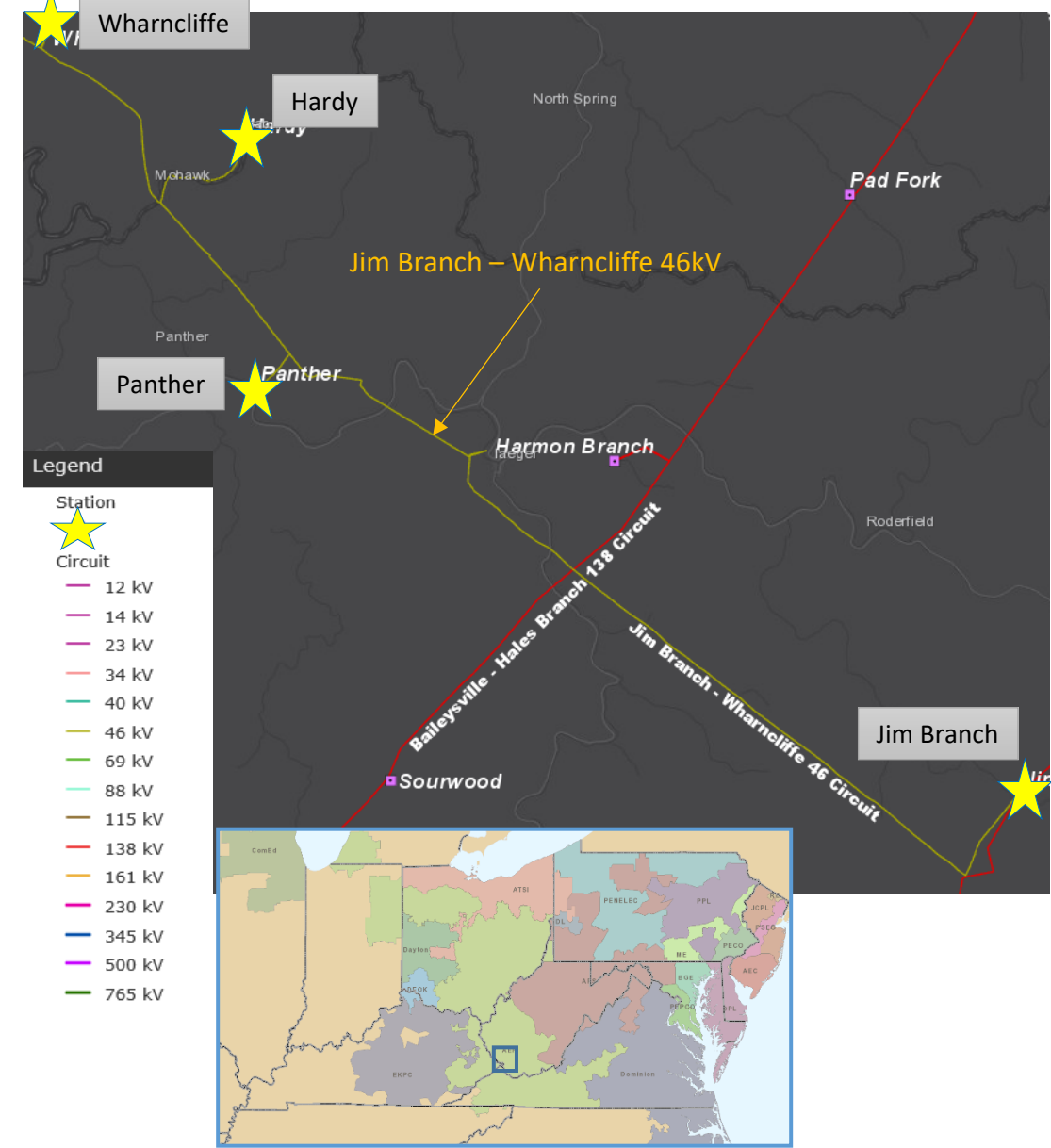

Need Number: AEP-2022-AP010

Process Stage: Submission of Supplemental Project for inclusion in the Local Plan 2/20/2024

Previously Presented:

Solutions Meeting 8/18/2023

Need Meeting 2/18/2022

Supplemental Project Driver: Equipment Condition/Performance/Risk

Specific Assumption Reference:

AEP Guidelines for Transmission Owner Identified Needs (AEP Assumptions Slide 13)

Jim Branch – Wharnccliffe 46 kV Continued:

Line Conditions Con't:

- The majority of the line has no static wire, making it inadequate for AEP current shielding angle requirements.
- The butt wrap grounding and typical shield angle is inadequate per current AEP Standards and can cause poor lightning performance. The current grounding system, poor shielding angle, and the electrical strength of the insulators do not meet current AEP and industry accepted criteria, making the line susceptible momentary and permanent outages, affecting customer reliability.
 - The inadequate grounding limits the available path to ground during any type of line fault, increasing the intensity the conductor and related hardware have to withstand during the fault. The reduced electrical strength of the insulators could lead to electrical damage to structures and hardware during a fault if the insulator were to fail from elevated electrical stresses.
- The line serves a peak load of 7 MVA at Hardy and Panther stations.

AEP Transmission Zone M-3 Process

Mingo and McDowell County, West Virginia

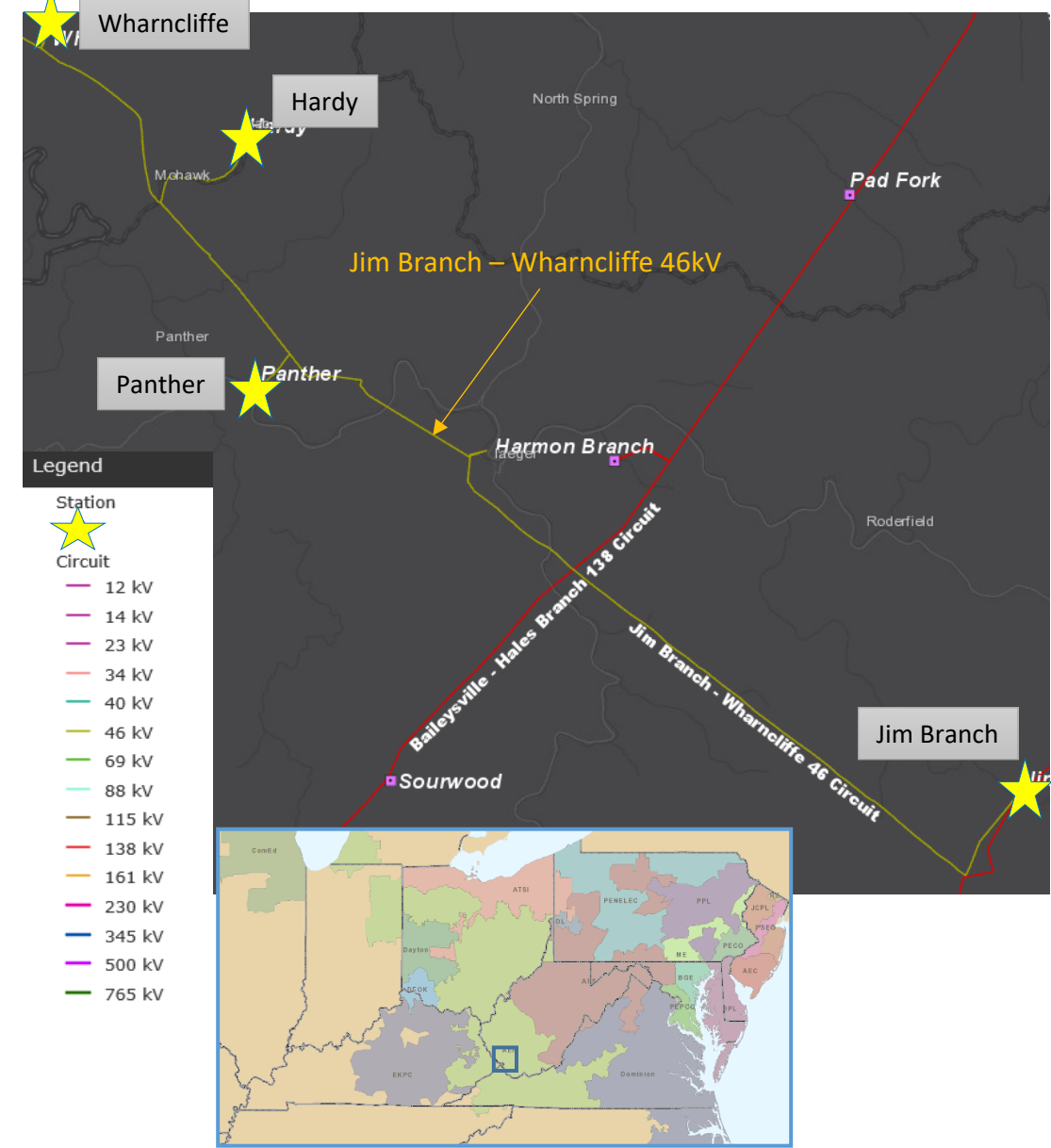

Need Number: AEP-2022-AP011

Process Stage: Submission of Supplemental Project for inclusion in the Local Plan 2/20/2024

Previously Presented:

- Solutions Meeting 8/18/2023
- Need Meeting 2/18/2022

Supplemental Project Driver: Equipment Condition/Performance/Risk

Specific Assumption Reference:

AEP Guidelines for Transmission Owner Identified Needs (AEP Assumptions Slide 13)

Problem Statement:

Sprigg Station:

138/69 – 46kV Transformer #1

- 1971 Vintage Transformer
- The presence of Ethane, along with the indication of overheating faults, indicates decomposition of the paper insulation that impairs the unit's ability to withstand future short circuit or through fault events.
- The dielectric is driven by the upward trend in insulation power factor, which indicates an increase in particles within the oil.
- The transformer has elevated moisture levels that are a result of gasket leaks or breakdown in oil or paper/pressboard insulation.

46/7.2kV GND Bank

- 1972 Vintage Transformer
- The elevated levels of Acetylene indicate increased decomposition of the paper insulating materials. The dielectric is driven by the upward trend in insulation power factor, which indicates an increase in particles within the oil.
- The transformer has elevated moisture levels that are a result of gasket leaks or breakdown in oil or paper/pressboard insulation.

Relays

- There are 82 electromechanical and 3 static relays which have significant limitations with regards to fault data collection and retention. These relays lack vendor support and have little to no access to spare parts.

AEP Transmission Zone M-3 Process

Mingo County, West Virginia

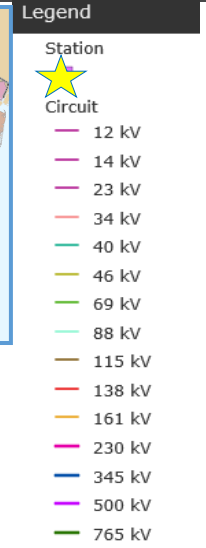
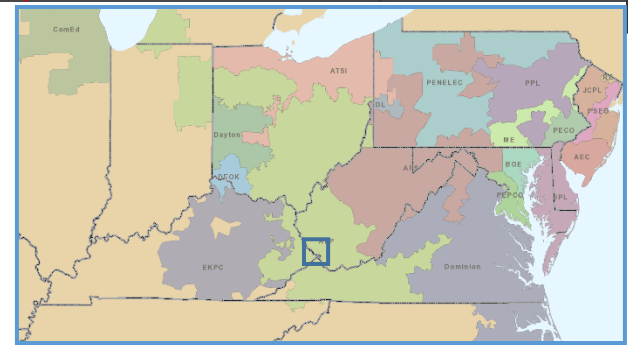
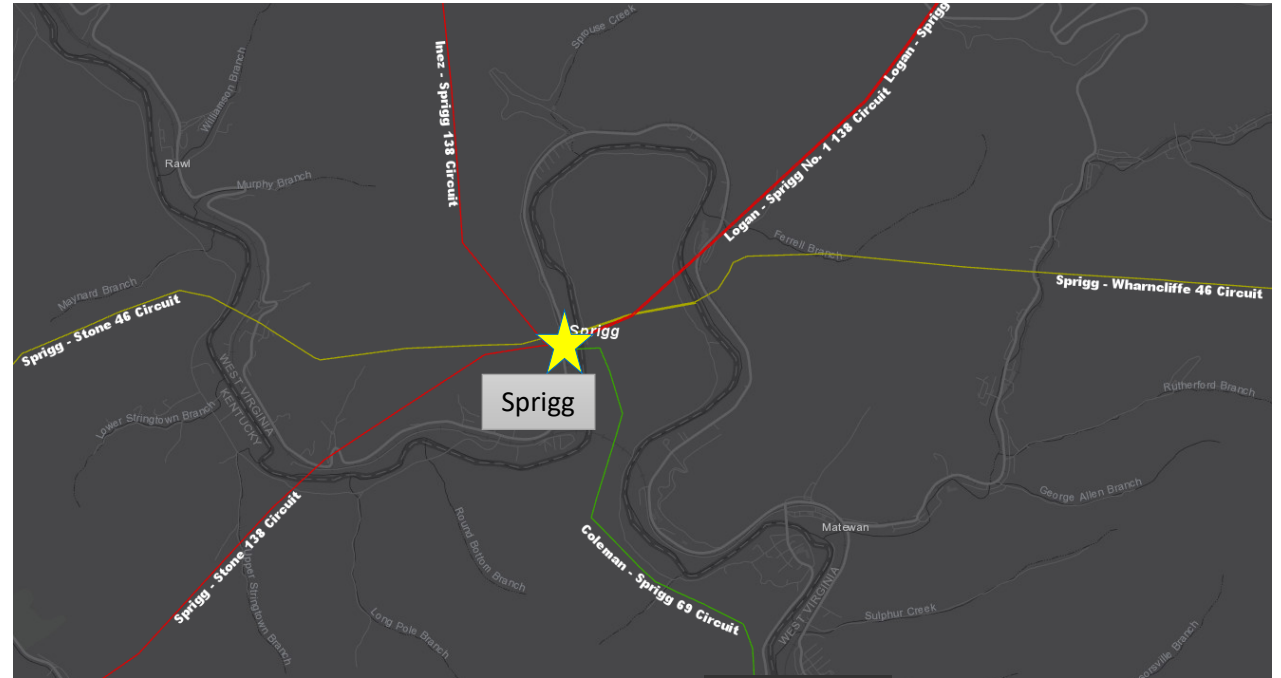

Need Number: AEP-2022-AP011

Process Stage: Submission of Supplemental Project for inclusion in the Local Plan 2/20/2024

Previously Presented:

Solutions Meeting 8/18/2023

Need Meeting 2/18/2022

Supplemental Project Driver: Equipment Condition/Performance/Risk

Specific Assumption Reference:

AEP Guidelines for Transmission Owner Identified Needs (AEP Assumptions Slide 13)

Sprigg Station Continued:

138kV Circuit Breakers A, B, C, D, and S

- A, B, C, and D are 1987 vintage and S is 1990 vintage SF6 filled circuit breakers.
- The manufacturer provides no support for these types of breakers and there are no spare parts available for these breakers.
- Circuit Breaker A, B, C, & D, have each exceeded the manufacturer’s recommended number of fault operations. Circuit Breaker S has experienced 6 low gas level malfunctions since December 2013. The age of the seals are causing the SF6 leaks to happen more frequently.

46kV Circuit Breakers H and N, 69kV Circuit Breaker T

- Circuit breaker H is 1960 vintage and N and T are 1972 vintage with all being oil filled without containment. The manufacturer provides no support for this fleet of circuit breakers and spare parts are not available. The breakers have oil contamination from aging gaskets allowing moisture and other particles to ingress.
- Circuit Breaker H, N and T have each exceeded the manufacturer’s recommended number of fault operations.

Station conditions and Flooding

- The Station and Control House has experienced many floods in the past (1957, 1963, 1977 and 2002).
- Foundations are crumbling in the 46kV yard and the 138kV yard.

AEP Transmission Zone M-3 Process

Mingo County, West Virginia

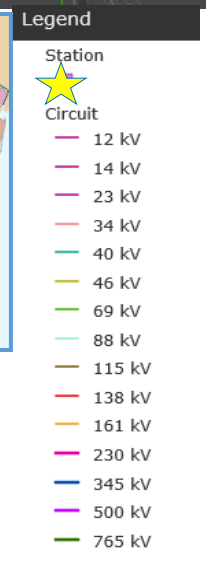
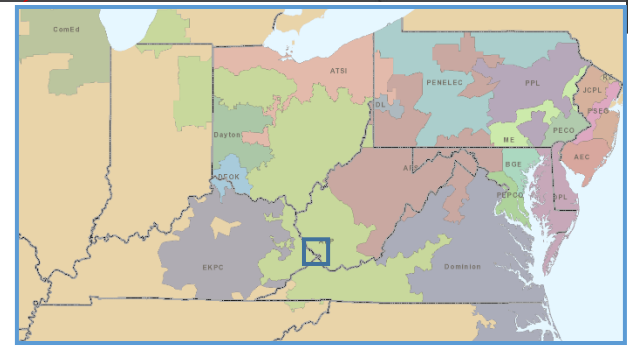
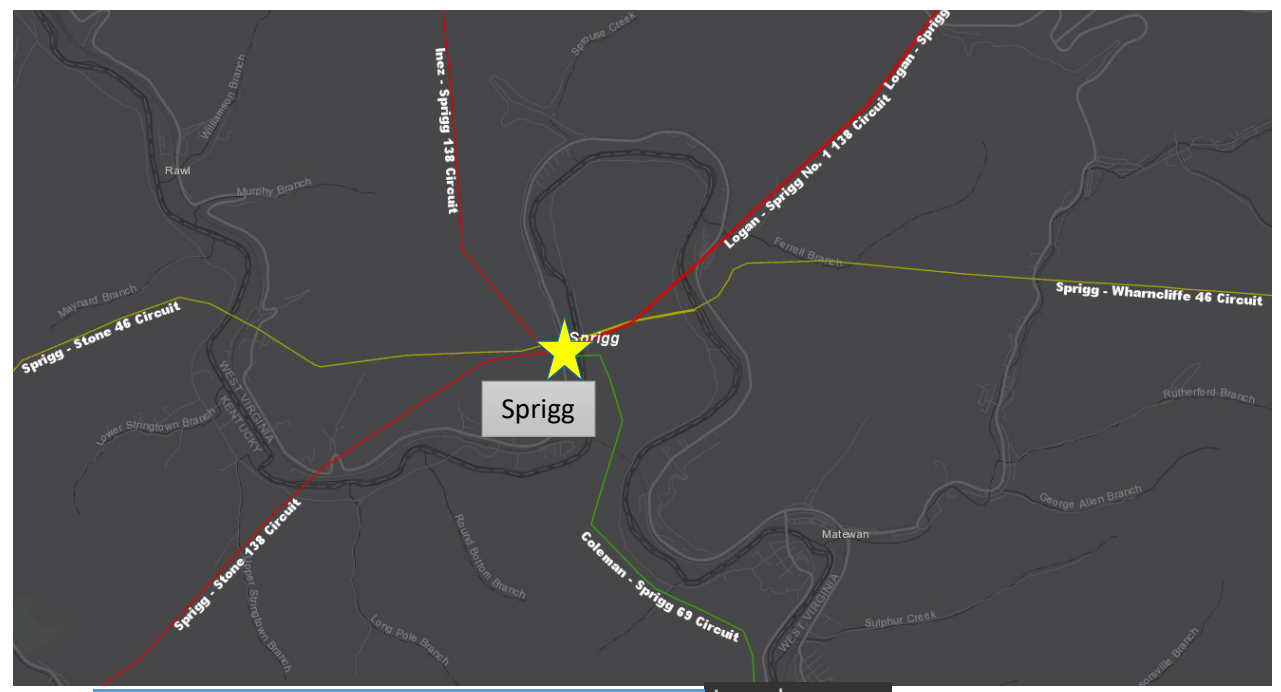

Need Number: AEP-2022-AP028

Process Stage: Submission of Supplemental Project for inclusion in the Local Plan 2/20/2024

Previously Presented:

Solutions Meeting 8/18/2023

Need Meeting 4/22/2022

Supplemental Project Driver: Customer Service

Specific Assumption Reference: AEP Guidelines for Transmission Owner Identified Needs (AEP Assumptions Slide 12)

Problem Statement:

- AEP Distribution has requested a new delivery point (Tug Fork) to serve initially 5 MVA.
- Hardy station has no room for expansion. Hardy station is located directly in front of a church and the church parking making expansion difficult in any direction. Roads to the station are single lane making it challenging to bring large equipment to the station.
- The Distribution transformers at Hardy station are 1940s vintage and based on the age of the units' insulating materials, the paper insulation is becoming increasingly brittle. In addition, the units lack thermally upgraded paper insulation. PHs A and B have high levels of Ethylene which is indicative of high decomposition of the paper insulating materials and high temperature thermal faults. In addition, PH C has high levels of Carbon Dioxide and Ethane which is indicative of excessive decomposition of the paper insulating materials and overheating.
- Panther station is a compact station and is located between a main road and a hill side which doesn't allow for expansion. Wash out is a major concern with the station being built next to the hill side. Roads and bridges to the station are narrow making it difficult to bring large equipment to the station.
- The Distribution transformers at Panther station are 1940s vintage and based on the age of the units' insulating materials, the paper insulation is becoming increasingly brittle. In addition, the units lack thermally upgraded paper insulation. The units have poor dielectric strength, decreasing the ability of the oil to withstand fault events which can damage the paper insulation.
- Neither Hardy or Panther stations have mobile access to pick up the loads in case of any transformer failure or outage.

AEP Transmission Zone M-3 Process McDowell County, West Virginia

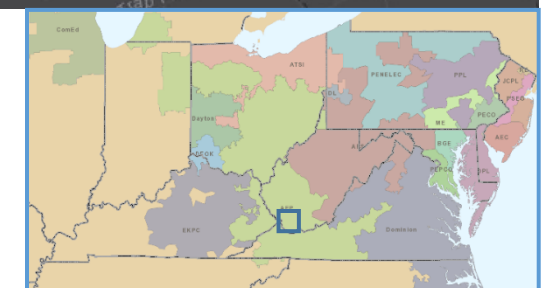
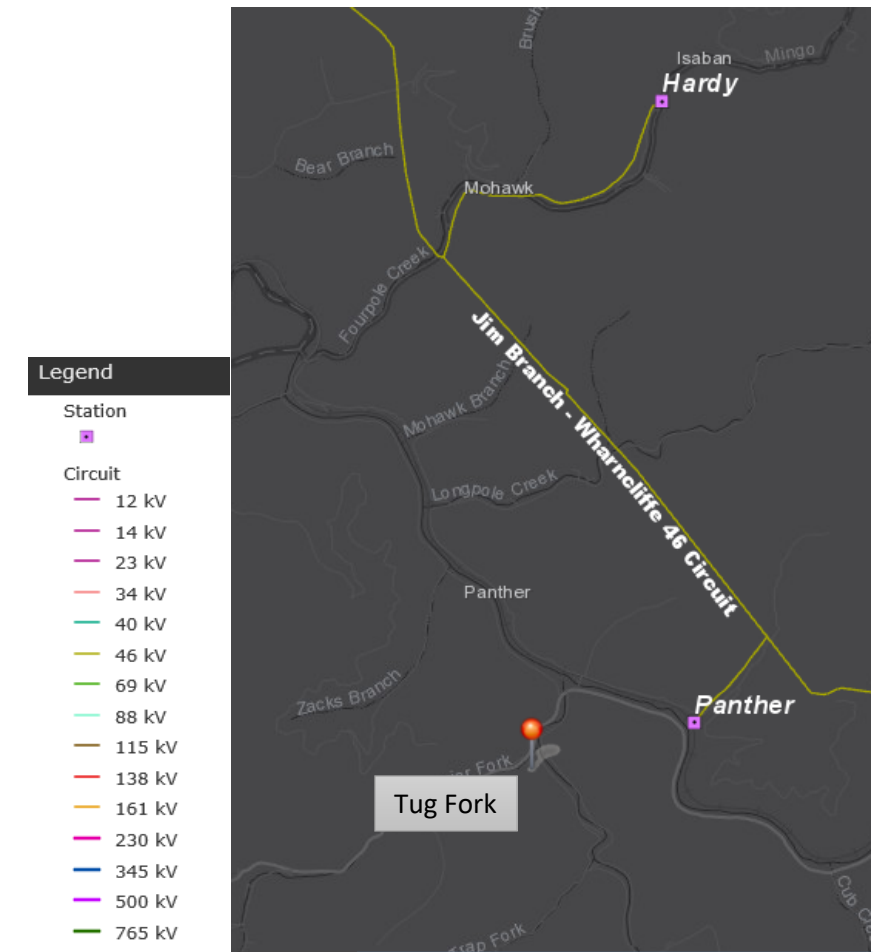

Need Number: AEP-2023-AP010

Process Stage: Submission of Supplemental Project for inclusion in the Local Plan 2/20/2024

Previously Presented:

Solutions Meeting 8/18/2023

Need Meeting 4/21/2023

Supplemental Project Driver: Equipment Condition/Performance/Risk

Specific Assumption Reference:

AEP Guidelines for Transmission Owner Identified Needs (AEP Assumptions Slide 13)

Problem Statement Hurley Station:

69/12kV TR-1

- 1977 Vintage Transformer
- The elevated and rising levels of acetylene indicate high decomposition of the paper insulating materials.
- The transformer has elevated moisture level which can be the result of gasket leaks or breakdown in the oil or paper/pressboard insulation. The decreasing and low level of dielectric strength, indicates an increase in particles within the oil, which in turn decreases the dielectric strength of the oil to withstand fault events. This can ultimately damage the paper insulation. The values of moisture and oil dielectric strength indicate the dielectric strength of the insulation system (oil and paper) is in poor condition.
- The condition of the transformer's wood tie foundation is unknown because it lies under the legacy asphalt oil containment.

Relay

- There are currently 7 electromechanical type relays which have significant limitations with regard to spare part availability and fault data collection and retention. In addition, these relays lack vendor support. 9 of the 11 relays (82% of all station relays) are in need of replacement.
- Station exists within the 100-year floodplain. This site has flooded multiple times, most recently in 2021.
- Low side expansion is not feasible due to proximity of the station to the road and high side expansion would be difficult without major earthwork due to the station being against a hillside.
- One 69kV line outage on the Hurley – Looney Creek 69kV circuit from 2017 to 2022 caused 863,000 CMI for distribution customers at Hurley due to being on a radial 69kV service and Distribution not having any transferable capability. The radial 69kV line is 10.1 miles long and the Distribution load is 12.5 MVA.
- Limited access off the road for station ingress/egress.

AEP Transmission Zone M-3 Process Buchanan County, Virginia

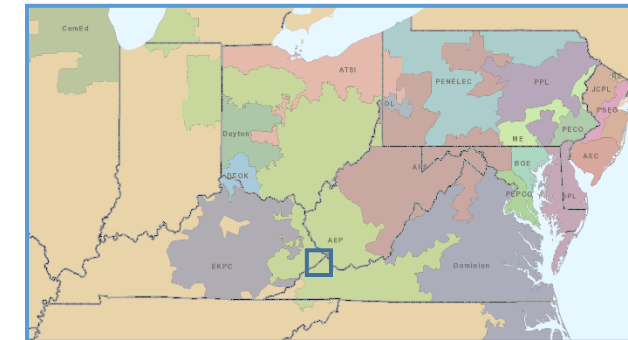
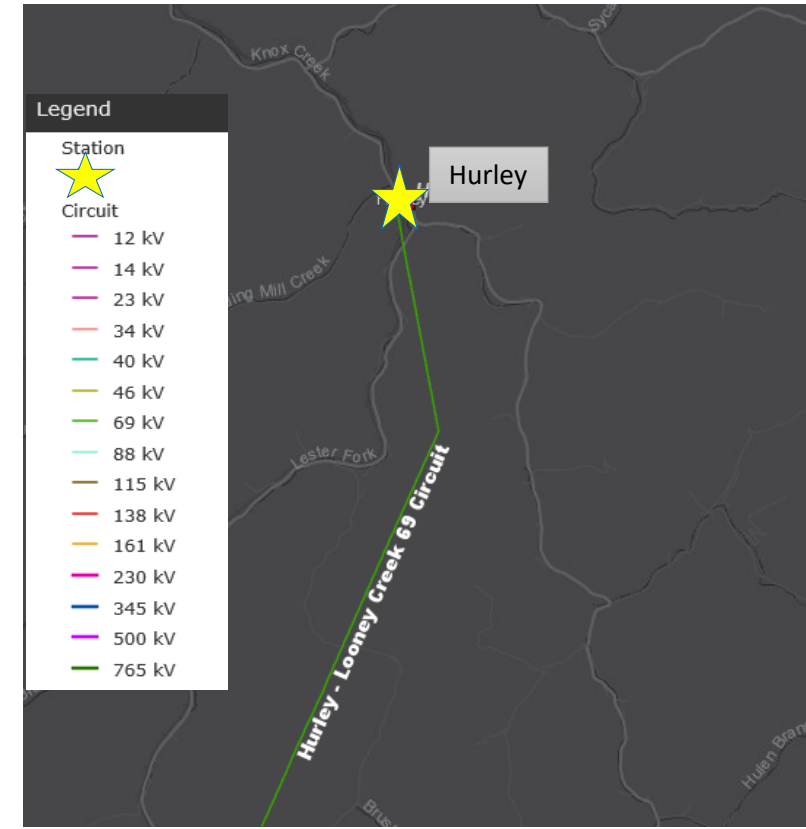

Overview Map

AEP Transmission Zone M-3 Process
 Pike County, KY and Mingo & McDowell Counties, WV
 Buchanan County, VA

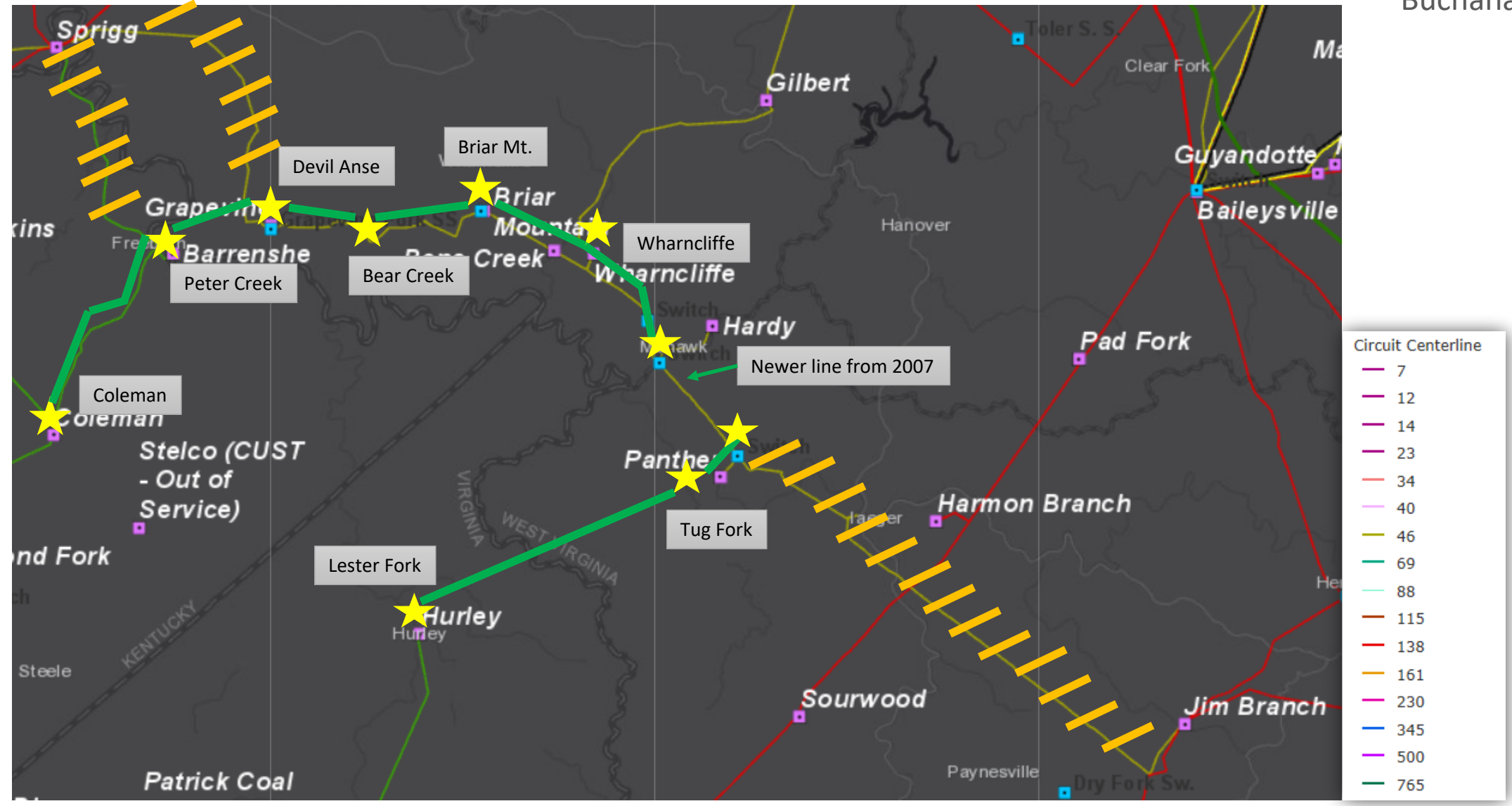



BOUNDLESS ENERGY™

Need Number(s): AEP-2022-AP007, AEP-2022-AP008, AEP-2022-AP009, AEP-2022-AP010, AEP-2022-AP011, AEP-2022-AP028, AEP-2023-AP010

Process Stage: Submission of Supplemental Project for inclusion in the Local Plan 2/20/2024

- Solution:**
- Coleman - Peter Creek 69kV line - Install new 69kV line with OPGW from Coleman station to Peter Creek Station. Total line length 5.8 miles. Rebuilding within the existing ROW, but some new ROW will be required to get from Coleman station to Peter Creek station. **Estimated Cost: \$19.2 M (s3147.1)**
 - Peter Creek - Wharncliffe 69kV line - Install new 69kV line with OPGW from the KY/WV State Line to Peter Creek Station. Total line length 0.1 miles. New ROW will be required to get from the WV/KY state line to Peter Creek station. **Estimated Cost: \$0.3 M (s3147.2)**
 - Peter Creek - Wharncliffe 69kV line - Install new 69kV line with OPGW from the KY/WV State Line to Wharncliffe Station. Intermediate station includes Bear Creek. Includes switching structures Devil Anse and Briar Mt. for Transmission customers and their delineation poles. Total line length 12.7 miles. Rebuilding within the existing ROW, but some new ROW will be required to get from the WV/KY state line to Devil Anse S.S. **Estimated Cost: \$44.7 M (s3147.3)**
 - Devi Anse S.S. Metering - One 69kV meter for the Transmission customer and one 69kV meter facing the WV/KY state line. **Estimated Cost: \$0.5 M (s3147.4)**
 - Briar Mt. S.S. Metering - One 69kV metering structure for the Transmission customer. **Estimated Cost: \$0.9 M (s3147.5)**
 - Huff Creek - Wharncliffe 46kV line - The remove the span into the takeoff and the first structure 556-109 then re-terminate the line into the new station takeoff structure on the Huff Creek – Wharncliffe 46kV line. **Estimated Cost: \$0.25 M (s3147.6)**
 - Tug Fork - Wharncliffe 69kV line - Install a new single circuit 69kV with OPGW line from existing Wharncliffe station to Tug Fork station totaling 5.9 miles long. Also reusing 2.3 miles of the Jim Branch – Wharncliffe line asset at 69kV that was rebuilt in 2007. Create 2.2 miles of greenfield ROW and reuse 3.7 miles of existing ROW from Tug Fork to Wharncliffe stations. **Estimated Cost: \$24.3 M (s3147.7)**
 - Lester Fork - Tug Fork 69kV line - Install a new single circuit 69kV with OPGW line from Lester Fork to Tug Fork stations crossing the VA/WV state border totaling 8.0 miles long. Create greenfield ROW from Lester Fork to Tug Fork stations crossing the VA/WV state border. **Estimated Cost: \$33.9 M (s3147.8)**
 - Looney Creek - Lester Fork 69kV line - Install new 69kV line with OPGW from structure 343-1A to the new Lester Fork Station at 0.25 miles. Remove structure 343-1 and the span into the Hurley Station at 0.1 miles. Create greenfield ROW from structure 343-1A to Lester Fork station at 0.25 miles. **Estimated Cost: \$2.51 M (s3147.9)**
 - Rapoca 69kV Customer - Replace the Rapoca Station hard tap from the Hurley - Looney Creek 69kV circuit with a Phase over Phase switch. **Estimated Cost: \$0.7 M (s3147.10)**
 - Bear Creek Station - Two 69kV MOABs that are automatic, and SCADA controlled for the Bear Creek 69kV work. **Estimated Cost: \$0.9 M (s3147.11)**
 - Wharncliffe Station - Upgrade the existing Wharncliffe station to 69kV. One 69kV Capacitor bank that is 11.5 MVAR and circuit switcher. One 69/46kV 50 MVA transformer and one 46kV circuit breaker facing Gilbert on the low side of the transformer. Reusing the existing three Transmission circuit breaker for the high side of the transformer and lines facing Tug Fork and Briar Mt. S.S. **Estimated Cost: \$5.9 M (s3147.12)**

AEP Transmission Zone M-3 Process

Pike County, KY

Mingo & McDowell Counties, WV

Buchanan County, VA

Existing

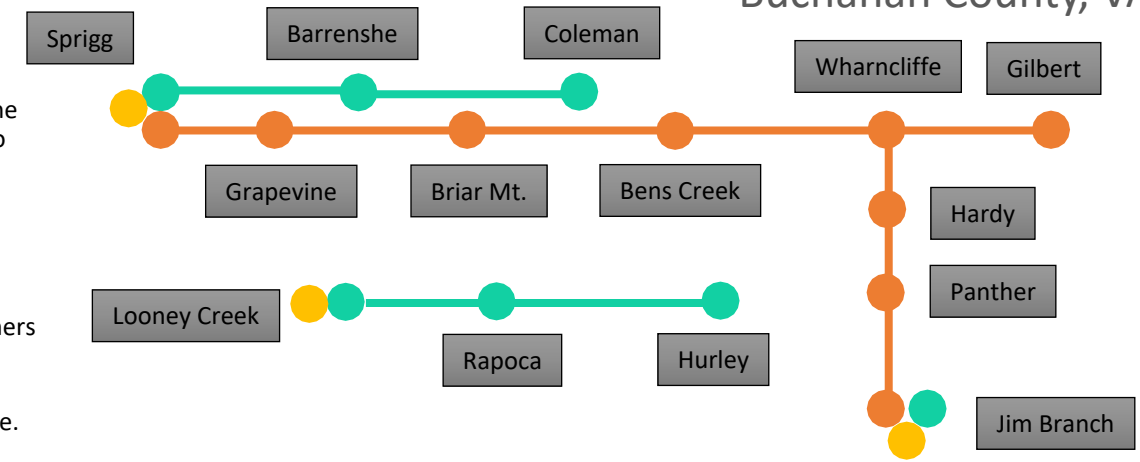

Proposed

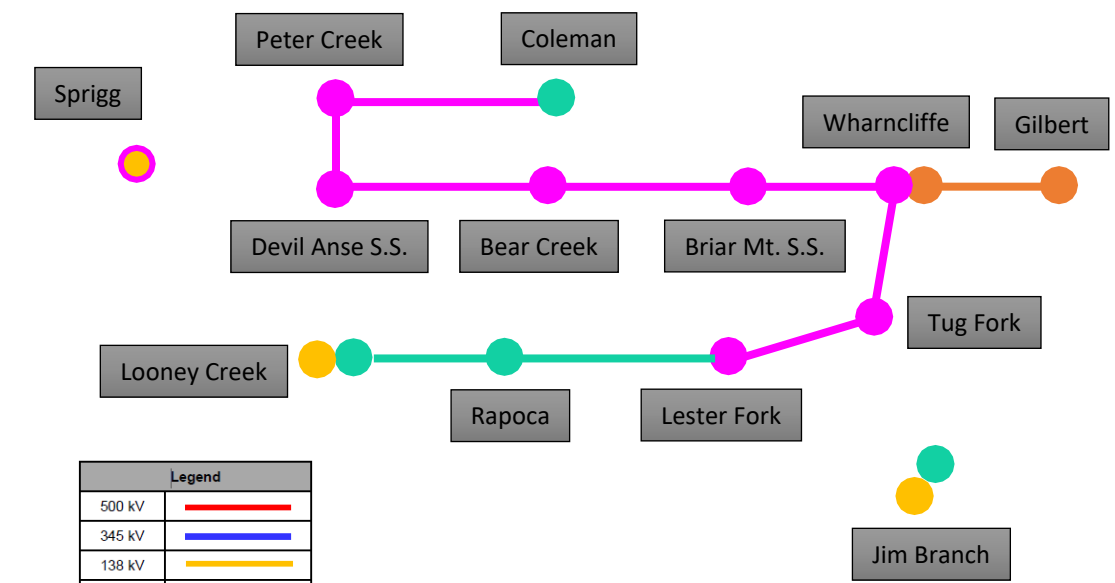

Legend	
500 kV	
345 kV	
138 kV	
69 kV	
46 kV	
23 kV	
New	



BOUNDLESS ENERGY™

Solution Continued:

- Tug Fork Station - Two 69kV circuit breakers with one facing Wharncliffe and the other facing Lester Fork stations. Includes 69kV bus work. **Estimated Cost: \$2.1 M (s3147.13)**
- Lester Creek Station - One 69kV meter facing Tug Fork for the state line crossing. **Estimated Cost: \$0.3 M (s3147.14)**
- Looney Creek Station - Replace the existing 69kV MOAB facing Lester Fork with a 69kV circuit breaker. **Estimated Cost: \$1.2 M (s3147.15)**
- Sprigg - Barrenshe 69kV line - Remove approximately 6.9 miles of Sprigg - Barrenshe 69kV line. **Estimated Cost: \$0.024 M (s3147.16)**
- Barrenshe – Coleman 69kV line - Remove approximately 6.2 miles of Barrenshe - Coleman 69kV line. **Estimated Cost: \$0.024 M (s3147.17)**
- Sprigg - Wharncliffe 46kV line - Remove approximately 1.29 miles of Sprigg - Wharncliffe 46kV line in KY. **Estimated Cost: \$1.1 M (s3147.18)**
- Sprigg - Wharncliffe 46kV line - Remove approximately 18.3 miles of Sprigg - Wharncliffe 46kV line in WV and remove the Grapevine Switching Structure. **Estimated Cost: \$14.2 M (s3147.19)**
- Jim Branch - Wharncliffe 46kV line - Remove approximately 19.7 miles of Jim Branch - Wharncliffe 46kV line. **Estimated Cost: \$15.3 M (s3147.20)**
- Hardy Tap 46kV line - Remove approximately 2.0 miles of the Hardy Tap 46kV line and remove the Hardy Switching Structure. **Estimated Cost: \$1.9 M (s3147.21)**
- Panther Tap 46kV line - Remove approximately 0.7 miles of the Panther Tap 46kV line. **Estimated Cost: \$0.69 M (s3147.22)**
- Briar Mt. Tap 46kV line - Remove approximately 0.1 miles of the Briar Mt. Tap 46kV line. **Estimated Cost: \$0.12 M (s3147.23)**
- Grapevine Tap 46kV line - Remove approximately 0.1 miles of the Grapevine Tap 46kV line. **Estimated Cost: \$0.45 M (s3147.24)**
- Jim Branch station Removal - Remove the 46kV Circuit Breaker P facing Panther and the Grounding Bank. **Estimated Cost: \$0.087 M (s3147.25)**
- Sprigg Station **Removal** - Remove all the 46kV bus and attached equipment. Remove the 138/69 – 46kV transformer and the 46/7.2KV GND Bank. Remove the 69kV bus and attached equipment. **Remove the 138kV equipment. Rebuild the station as a four 138kV circuit breaker ring bus station. Estimated Cost: \$1.1M-\$5M (s3147.26)**
- Coleman Station - Replace 69kV circuit breaker H towards Peter Creek and risers. **Estimated Cost: \$0 (Distribution Cost) (s3147.27)**
- Barrenshe Station - Removal of the Distribution station and equipment. **Estimated Cost: \$0 (Distribution Cost) (s3147.28)**

AEP Transmission Zone M-3 Process
Pike County, KY
Mingo & McDowell Counties, WV
Buchanan County, VA

Existing

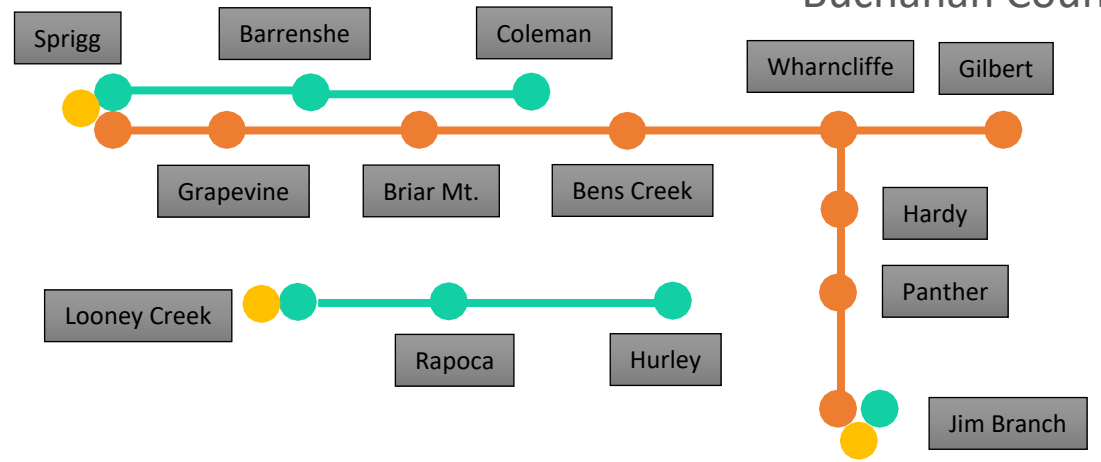

Proposed

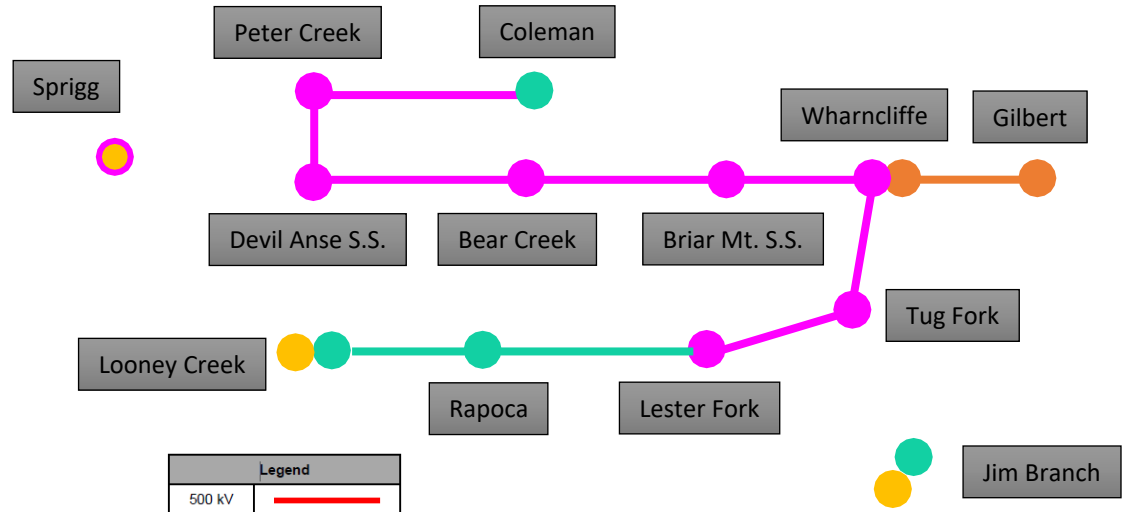

Legend	
500 kV	
345 kV	
138 kV	
69 kV	
46 kV	
23 kV	
New	

Solution Continued:

- Peter Creek Station - A new Distribution station that is replacing Barrenshe station that has a MOAB that is Scada controlled facing Coleman and a 69kV circuit breaker facing Devil Anse S.S. One 69kV circuit switcher and a 20 MVA 69/12kV Transformer and 4 Distribution feeders. **Estimated Cost: \$0 (Distribution Cost) (s3147.29)**
- Grapevine Station - Removal of the Distribution station and equipment. **Estimated Cost: \$0 (Distribution Cost) (s3147.30)**
- Bear Creek Station - A new Distribution station that is replacing Grapevine station that has one 69kV circuit switcher and a 20 MVA 69/34kV Transformer and two Distribution feeder. Also helping to break up a large Distribution circuit out of Pigeon Creek station. **Estimated Cost: \$0 (Distribution Cost) (s3147.31)**
- Briar Mt. Station - Removal of the Distribution station and equipment. **Estimated Cost: \$0 (Distribution Cost) (s3147.32)**
- Bens Creek Station - Removal of the Distribution station and equipment. **Estimated Cost: \$0 (Distribution Cost) (s3147.33)**
- Wharncliffe Station - Add one 69kV circuit switcher and a 20 MVA 69/12kV transformer and one Distribution feeder to pick up the load from the retired Bens Creek and Briar Mt. stations. **Estimated Cost: \$0 (Distribution Cost) (s3147.34)**
- Tug Fork Station - A new Distribution station that is replacing Hardy and Panther stations that has one 69kV circuit switcher and a 20 MVA 69/12kV Transformer and three Distribution feeder. **Estimated Cost: \$0 (Distribution Cost) (s3147.35)**
- Hardy and Panther Stations - Removal of the Distribution stations and equipment. **Estimated Cost: \$0 (Distribution Cost) (s3147.36)**
- Lester Fork Station - A new Distribution station that is replacing Hurley station that has two MOABs that are Scada controlled, one 69kV circuit switcher and a 20 MVA 69/12kV Transformer and three Distribution feeder. **Estimated Cost: \$0 (Distribution Cost) (s3147.37)**
- Hurley Station - Removal of the Distribution station and equipment. **Estimated Cost: \$0 (Distribution Cost) (s3147.38)**
- Build 2 fiber station transitions using OPGW at Coleman and Peter Creek stations. **Estimated Cost: \$0.2 M (s3147.39)**
- Build 4 fiber station transitions using OPGW at Devil Anse S.S. Bear Creek, Briar Mt. S.S. and Wharncliffe. **Estimated Cost: \$0.7 M (s3147.40)**
- Lester Fork – Wharncliffe Fiber - Build 3 fiber station transitions using OPGW at Tug Fork, Wharncliffe and Lester Fork. Remove one of the existing shield wires and replace it with an OPGW at 2.3 miles on the Jim Branch – Wharncliffe line asset that is being reused from 2007. **Estimated Cost: \$5.1 M (s3147.41)**

Total Estimated Transmission Cost: ~~\$178.66 M~~ \$182.56 M

Existing

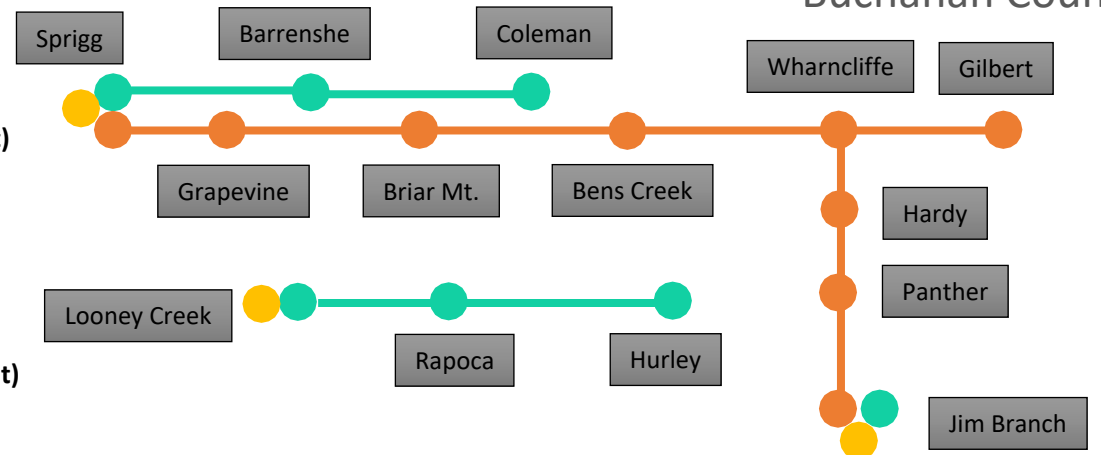

Proposed

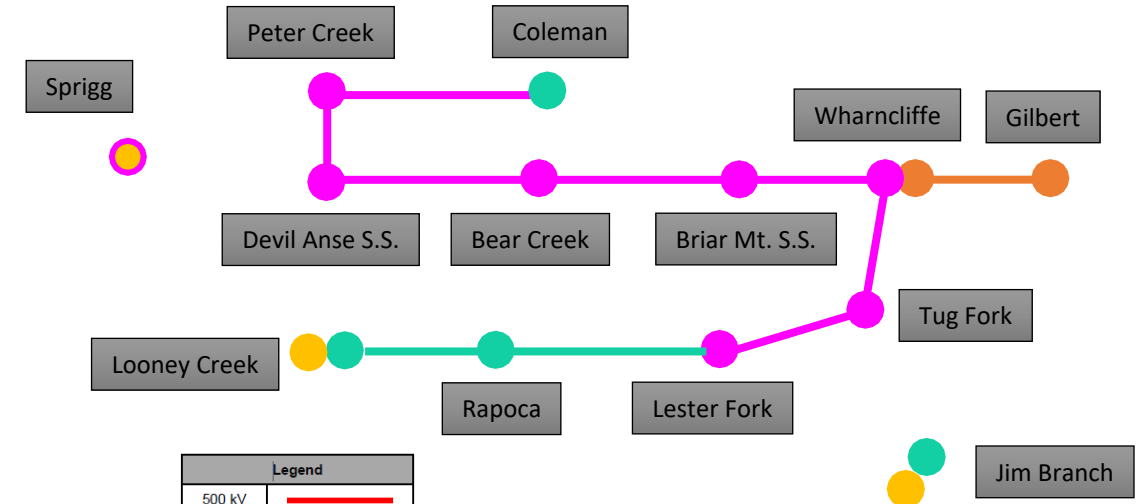

Legend	
500 kV	
345 kV	
138 kV	
69 kV	
46 kV	
23 kV	
New	



BOUNDLESS ENERGY™

Solution Continued:

Ancillary Benefits: The greenfield stations and new 69kV line addresses asset concerns on stations and lines that were in the flood plain, had aging equipment, tight clearances, and little to no room for vehicle pull off. The project will provide better sectionalizing to Distribution and Transmission customers. The project will retire roughly 40 miles of legacy 46kV lines and replace with less overall line mileage (31 miles). The project will bring looped Transmission service to the Distribution customer served from the old Hurley station. Hurley station exceeds the 75 MVA * mile guideline.

Projected In-Service: 6/1/2030

Supplemental Project ID: s3147.1-.41

Project Status: Scoping

AEP Transmission Zone M-3 Process
Pike County, KY
Mingo & McDowell Counties, WV
Buchanan County, VA

Existing

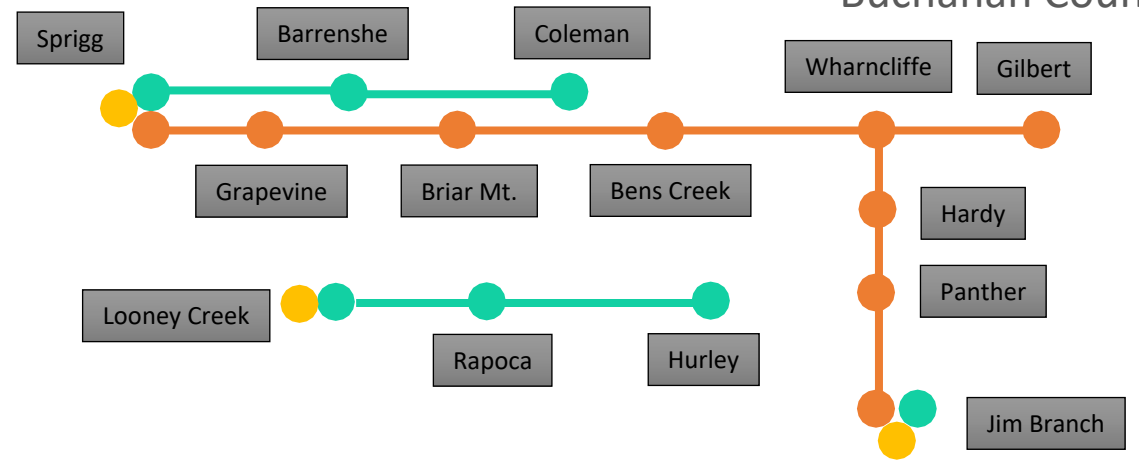

Proposed

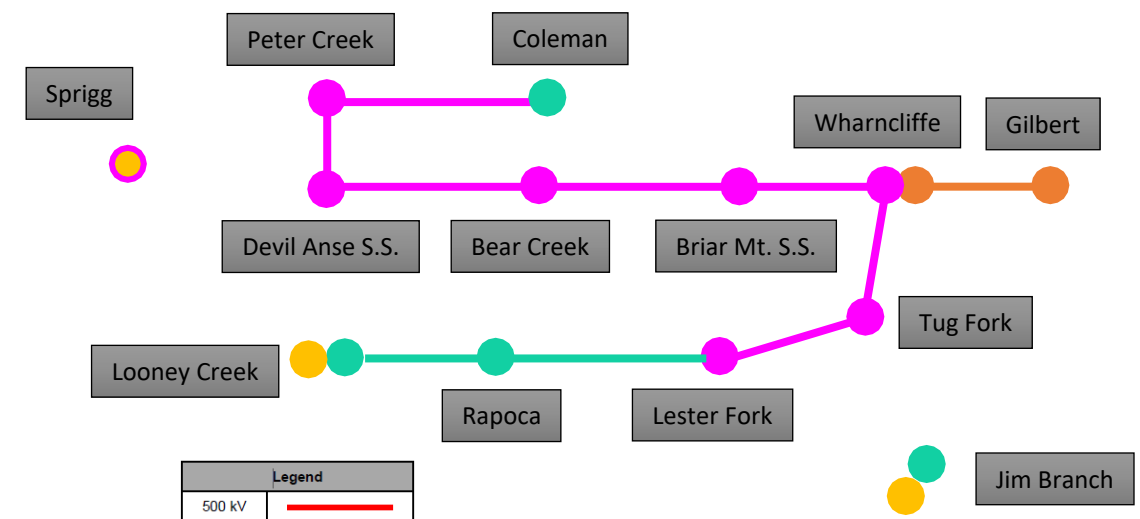

Legend	
500 kV	
345 kV	
138 kV	
69 kV	
46 kV	
23 kV	
New	

AEP Transmission Zone M-3 Process Sorenson – Desoto 345kV

Need Number: AEP-2021-IM028

Process Stage: Submission of Supplemental Project for inclusion in the Local Plan 2/20/2024

Previously Presented:

Solutions Meeting 08/08/2023

Needs Meeting: 9/17/2021

Supplemental Project Driver: Equipment Condition/Performance/Risk

Specific Assumption Reference: AEP Guidelines for Transmission Owner Identified Needs (AEP Assumptions Slide 13)

Model: N/A

Problem Statement:

Desoto – Sorenson 345kV line (51.8 miles):

- Majority (211/216) structures are original 1952 Steel Lattice
- Majority (51.8 miles) of Conductor is 1952 vintage paper expanded conductor on the Sorenson – Desoto, Sorenson – Keystone and Keystone – Desoto circuits.
- Since 2014 there have been 22 momentary and 12 permanent outages across this line asset.
- The Paper Expanded conductor is difficult to splice during repairs due to the unavailability of like for like replacement conductor.
- Line is prone to galloping and causes issues for sensitive customers in the Marion and Ft Wayne area.
- 19 structures on the full Tanners Creek – Desoto – Sorenson asset were investigated at the ground and 38 structures were assessed by drone.
 - 20 of these structures had rust or galvanizing
 - 11 had broken/ashes or rusted insulators
 - 6 had sliding/bent or damaged dampers
 - 1 had broken spacers
- With 211 open conditions total, 124 of the 216 structures have at least one open condition. These open conditions include but are not limited to the following.
 - Loose braces; damaged, loose, or rust heavy lacing; rusty legs; broken, damaged, or gunshot conductor; broken or corroded shield wire; and significant hardware issues.

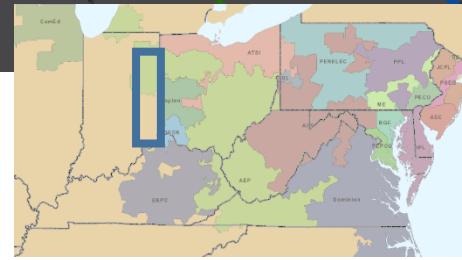
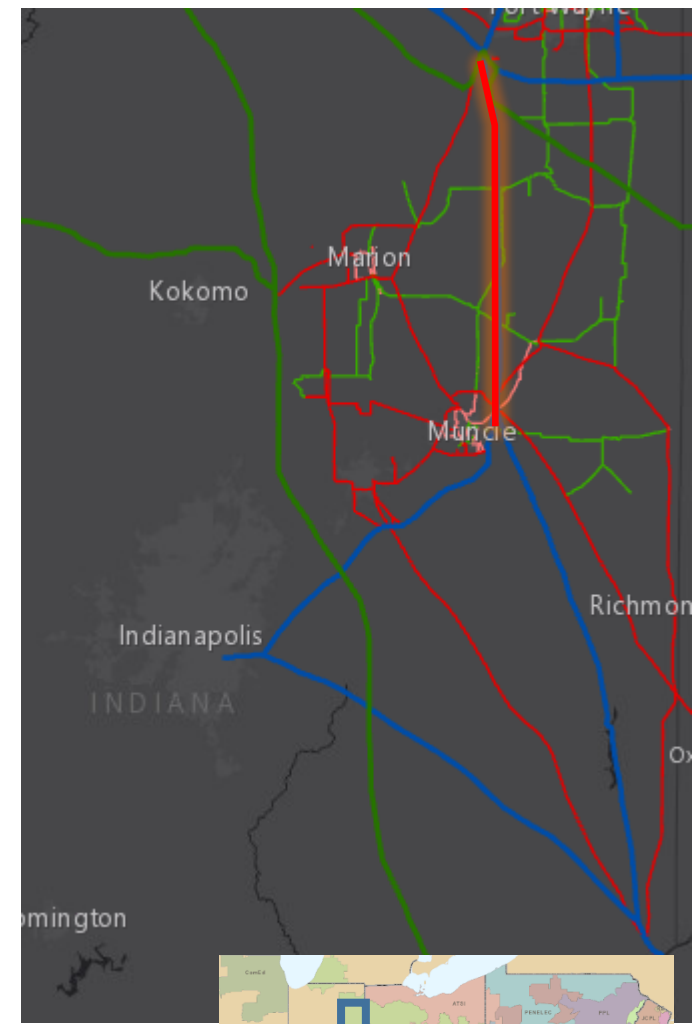



BOUNDLESS ENERGY™

AEP Transmission Zone M-3 Process Sorenson – Desoto 345kV

Need Number: AEP-2021-IM028

Process Stage: Submission of Supplemental Project for inclusion in the Local Plan 2/20/2024

Solution:

Sorenson – Desoto 345kV:
Rebuild the ~51.5 mile line as is using double circuit 345kV construction. Replace jumpers at Sorenson and Desoto to accommodate the new structure entrances at the stations.

Existing Conductor, Circuit Ratings: 1275 and 1350 ACSR/PE, 2303 ACAR, 897/897/1138/1138 SN/SE/WN/WE MVA

New Conductor, Circuit Ratings: 2-954 ACSR, 1025/1318/1298/1522 SN/SE/WN/WE MVA

Estimated Cost: \$202.4M

Projected In-Service: 06/10/2027

Supplemental Project ID: s3148.1

Project Status: Scoping

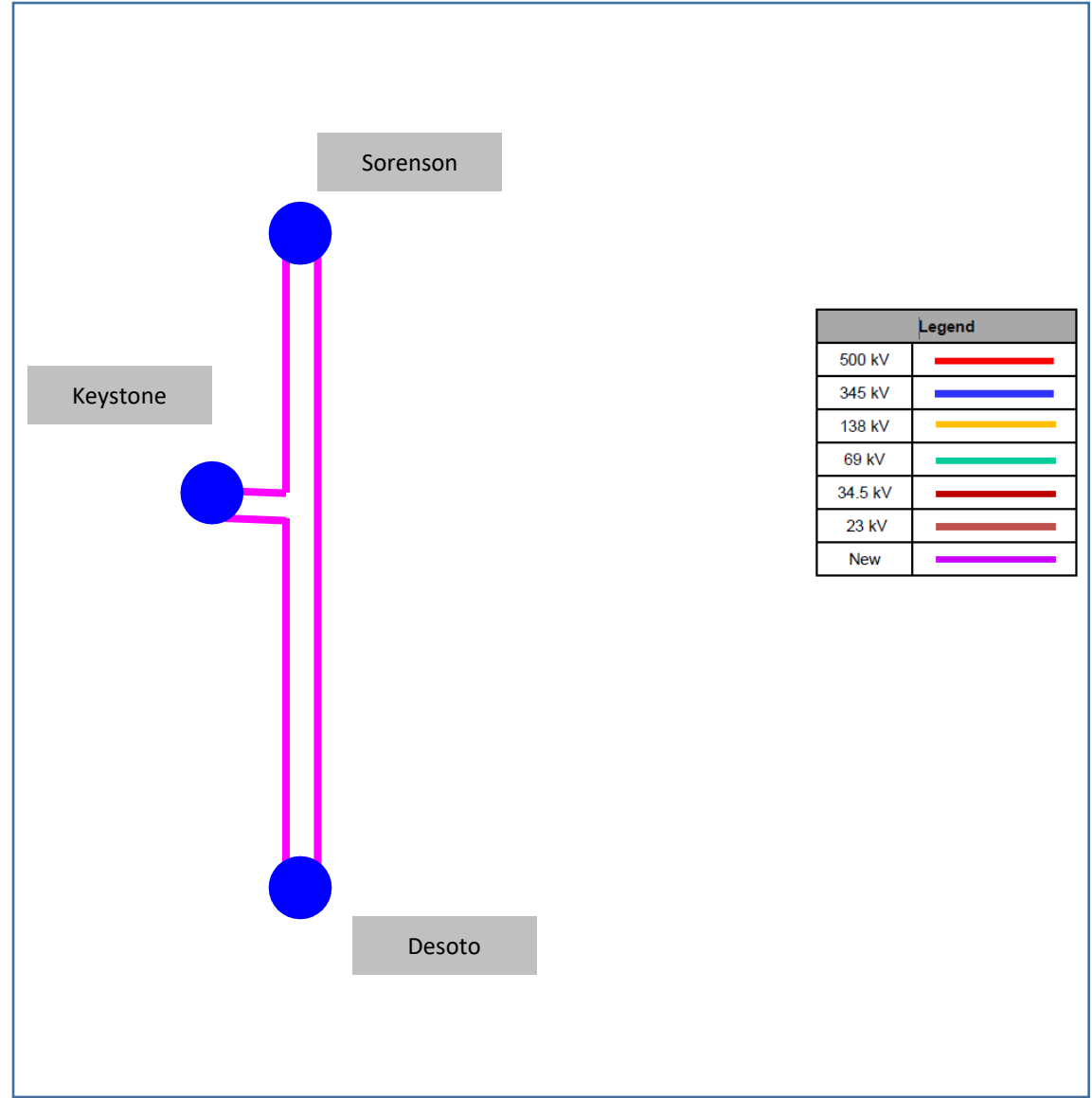

Need Number: AEP-2021-OH025

Process Stage: Submission of Supplemental Project for inclusion in the Local Plan 2/20/2024

Previously Presented:

Solutions Meeting 10/20/2023

Need Meeting 05/21/2021

Project Driver: Equipment Condition/Performance/Risk

Specific Assumption Reference:

AEP Guidelines for Transmission Owner Identified Needs (AEP Assumptions Slide 13)

Problem Statement:

South Coshocton – Wooster 138 kV Transmission Line: is 39.7 miles long and consists of mostly wooden H-frame structures with vertical insulators, originally installed in 1957 with 477,000 CM ACSR 26/7 (Hawk) conductor. The line asset comprises 22.8 miles of the Ohio Central-West Millersburg circuit, 15.2 miles of the West Millersburg-Wooster circuit (entirety), and 1.7 miles of the Ohio Central-South Coshocton circuit.

Total Structure Count: 214

Outage History:

- Momentary (10) & Permanent Outages (7)
- CMI: 545,905 (Past Five Years)

Open Conditions:

- 54 structures with at least one open condition, which equates to 25.4% of the structures on this line.
- 40 structure-based open conditions consisting of broken structures, insect damage, rot heart, rot top, woodpecker holes, rot pocket, split poles and rot top on filler blocks.
- 1 conductor-based open condition consisting of a damaged conductor.
- 4 grounding-based open conditions consisting of broken ground lead wires and broken structure grounds.
- 9 hardware-based open conditions consisting of broken/burnt insulators.
- Structure Age: 79% 1950's, 4% 1960's, 1% 1970's, 16% 1980's, 1% 1990's, 4% 2000's

Operational Concerns:

- The 138kV pathway provides a 138kV source for 4- sub-transmission source stations (South Coshocton, West Coshocton, West Millersburg, and Wooster).
- The 138kV pathway serves customers at two Holmes-Wayne Co-op stations and two AEP Ohio distribution stations.
- The 138kV pathway has experienced real-time PCLLRW overload alerts during heavy west-to-east and south-to-north system transfer periods.

AEP Transmission Zone M-3 Process Coshocton, Holmes, & Wayne Counties, Ohio

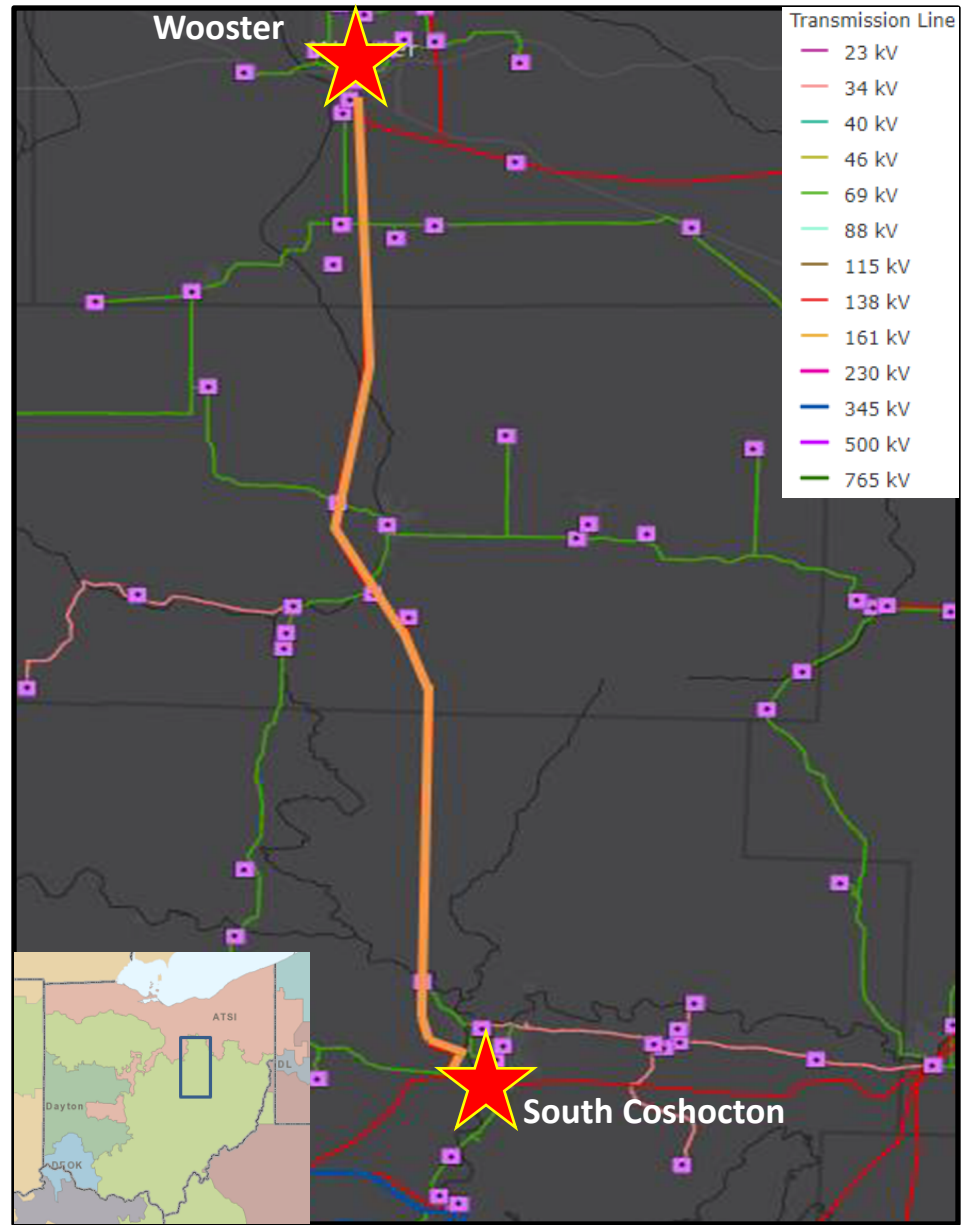

AEP Transmission Zone M-3 Process South Coshocton – Wooster Rebuild

Need Number: AEP-2021-OH025

Process Stage: Submission of Supplemental Project for inclusion in the Local Plan 2/20/2024

Solution:

Wooster – South Coshocton: The 37.7-mile line will be rebuilt using 795 ACSR DRAKE to alleviate identified asset renewal conditions. This includes the 15.2-mile West Millersburg – Wooster 138kV circuit as well a portion of the 30.9-mile single circuit Ohio Central – West Millersburg 138kV circuit up to structure 13 outside Ohio Central station. **Estimated Cost \$96.5M (s3140.1)**

Perform remote end work at Wooster **Estimated Cost \$0.501M (s3140.2)**

Perform remote end work at West Millersburg **Estimated Cost \$0.503M (s3140.3)**

Total Estimated Transmission Cost: \$97.54M

Projected In-Service: 10/31/2026

Supplemental Project ID: s3140.1-.3

Project Status: Scoping

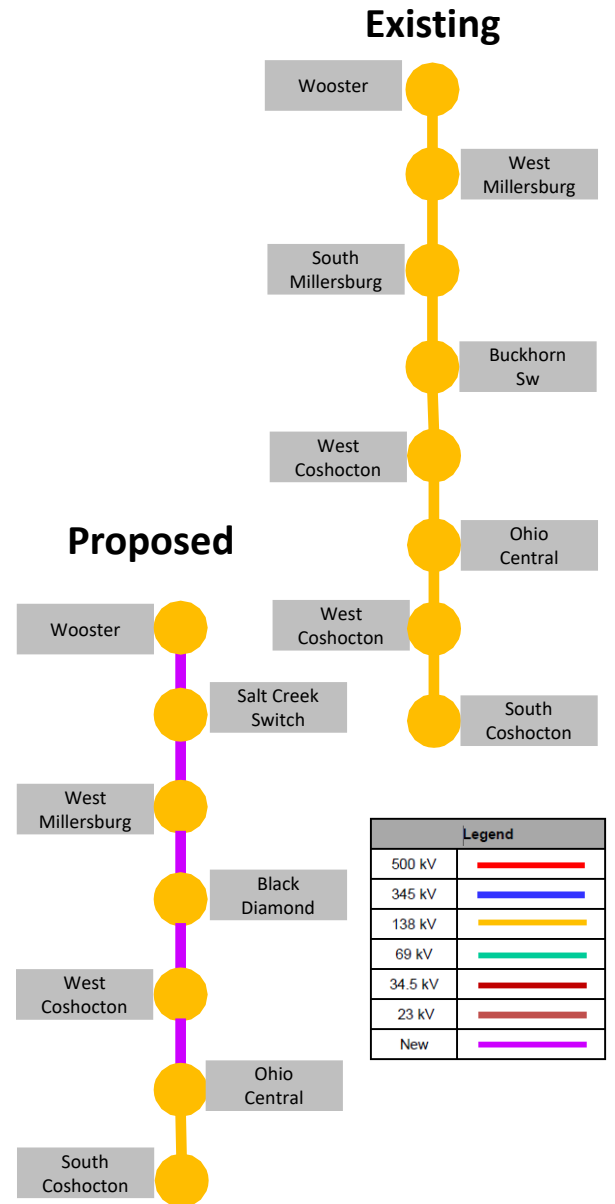

Need Number: AEP-2023-AP011

Process Stage: Submission of Supplemental Project for inclusion in the Local Plan 2/20/2024

Previously Presented:

Solution Meeting 10/20/2023

Need Meeting 4/21/2023

Supplemental Project Driver: Customer Service

Specific Assumption Reference: AEP Guidelines for Transmission Owner Identified Needs (AEP Assumptions Slide 12)

Problem Statement:

- AEP Distribution has requested a new delivery point (Snowville).
- The Distribution customers south of Claytor Lake are fed by one 34.5kV distribution circuit out of Wurno station and the circuit has one lake crossing. This circuit is currently 187-line miles long and has no other 34.5kV distribution circuit ties. Over the past five years, there were 223 distribution outages resulting in 5.9 million CMI.
- The greenfield Snowville station will pick up 6.5 MVA from Wurno station.

AEP Transmission Zone M-3 Process Pulaski County, Virginia

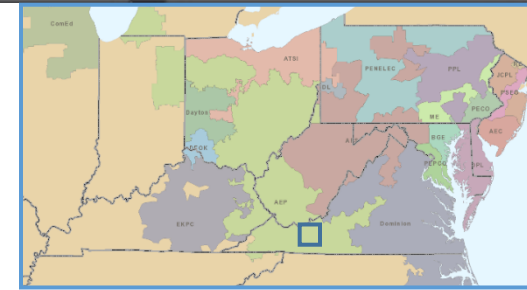
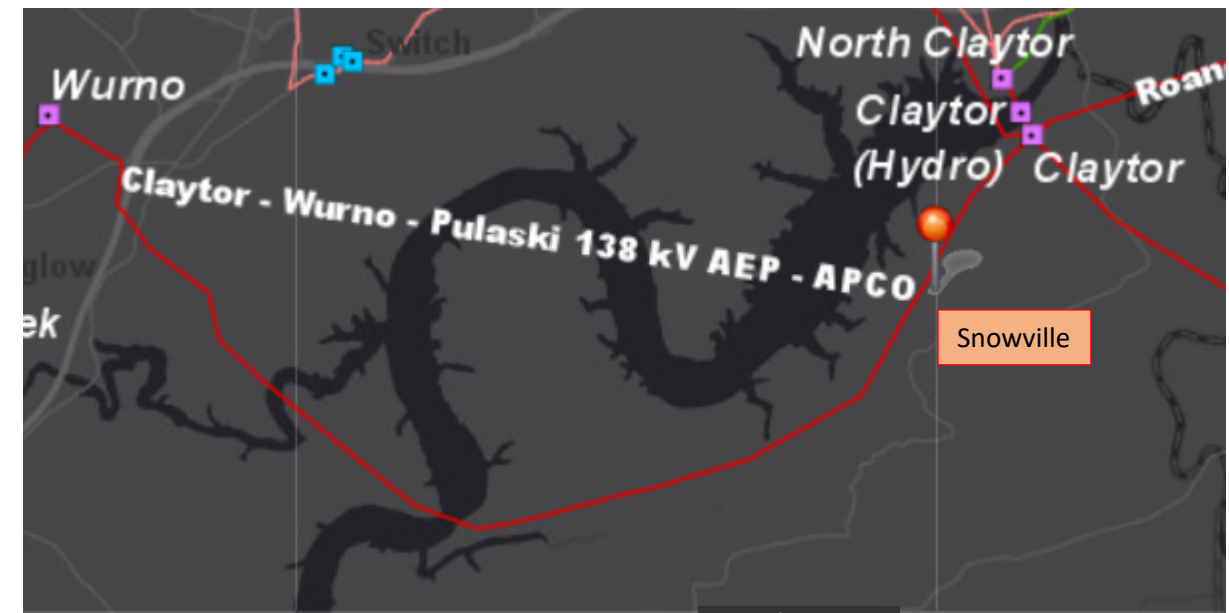

Legend

Station



Circuit

- 12 kV
- 14 kV
- 23 kV
- 34 kV
- 40 kV
- 46 kV
- 69 kV
- 88 kV
- 115 kV
- 138 kV
- 161 kV
- 230 kV
- 345 kV
- 500 kV
- 765 kV



BOUNDLESS ENERGY™

Need Number(s): AEP-2023-AP011

Process Stage: Submission of Supplemental Project for inclusion in the Local Plan 2/20/2024

Solution:

Snowville Station

- The greenfield station will contain a 138/34.5 kV 30 MVA transformer with high side circuit switcher. There will be two 34.5 kV feeders from the station. The 138 kV side will be a straight bus with two 138 kV MOABs. **Estimated Cost: \$0 (Distribution cost) (s3141.1)**

Snowville 138kV Line Extension

- The line extension will tap the Claytor – Wurno - Pulaski 138kV line and bring the line in and out of the greenfield Snowville station by building 0.1 miles of greenfield double circuit 138kV line. **Estimated Cost: \$1.48M (s3141.2)**

Snowville Fiber Line Extension

- Build 2.0 miles of 144 ADSS Telecom underbuilt cable to connect Snowville station to Claytor station. **Estimated Cost: \$0.5M (s3141.3)**

Estimated Total Transmission Cost: \$1.98 M

Ancillary Benefits: Distribution customers are currently served from Wurno station on the other side of the lake, causing a lot of outages due to one lake crossing. Snowville station will reduce outages for Distribution customers due to having a reliable source on their side of the lake.

Projected In-Service: 10/31/2025

Supplemental Project ID: s3141.1-.3

Project Status: Scoping

Model: 2028 RTEP

AEP Transmission Zone M-3 Process Pulaski County, Virginia

Existing

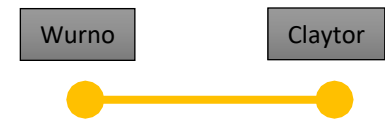

Legend	
500 kV	
345 kV	
138 kV	
69 kV	
34.5 kV	
23 kV	
New	

Proposed

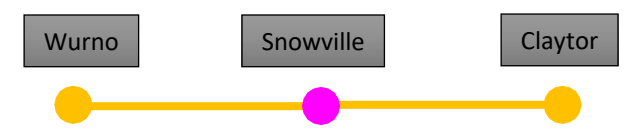

Need Number: AEP-2022-OH043

Process Stage: Submission of Supplemental Project for inclusion in the Local Plan 2/20/2024

Previously Presented:

Solution Meeting 10/20/2023

Need Meeting 07/22/2022

Project Driver:

Equipment Material/Condition/Performance/Risk

Specific Assumption Reference:

AEP Guidelines for Transmission Owner Identified Needs (AEP Assumptions Slide 13)

Problem Statement:

Van Wert - Haviland 69kV Line(1926) :

- Length of Line: 10.06 Miles
- Total Structure Count: 249
 - Wooden, Steel Monopole Structures
 - Vertical post insulators
- Conductor Types: 556.5 ACSR 18/1 (Osprey), 4/0 COOPER, 556.5 ALUMINUM 19 (Dahlia), 795 ACSR 26/7 (Drake)
- Outage History: 1 Momentary and 2 Permanent outages – average duration of 38.72 hours, 66.6K CMI between 2015 and 2020
- Open Conditions: 19, including splice/dead end conductor issues, damaged/missing ground lead wires, broken shield wire, disconnected grounding mat and chipped insulators
- The Van Wert - Haviland line fails to meet 2017 NESC Grade B loading criteria, current AEP structural strength requirements, and the current ASCE structural strength requirements. The line is insulated with vertical post insulators that do not meet current AEP standards for CIFO and minimum leakage distance requirements.

AEP Transmission Zone M-3 Process Paulding & Van Wert Co., OH

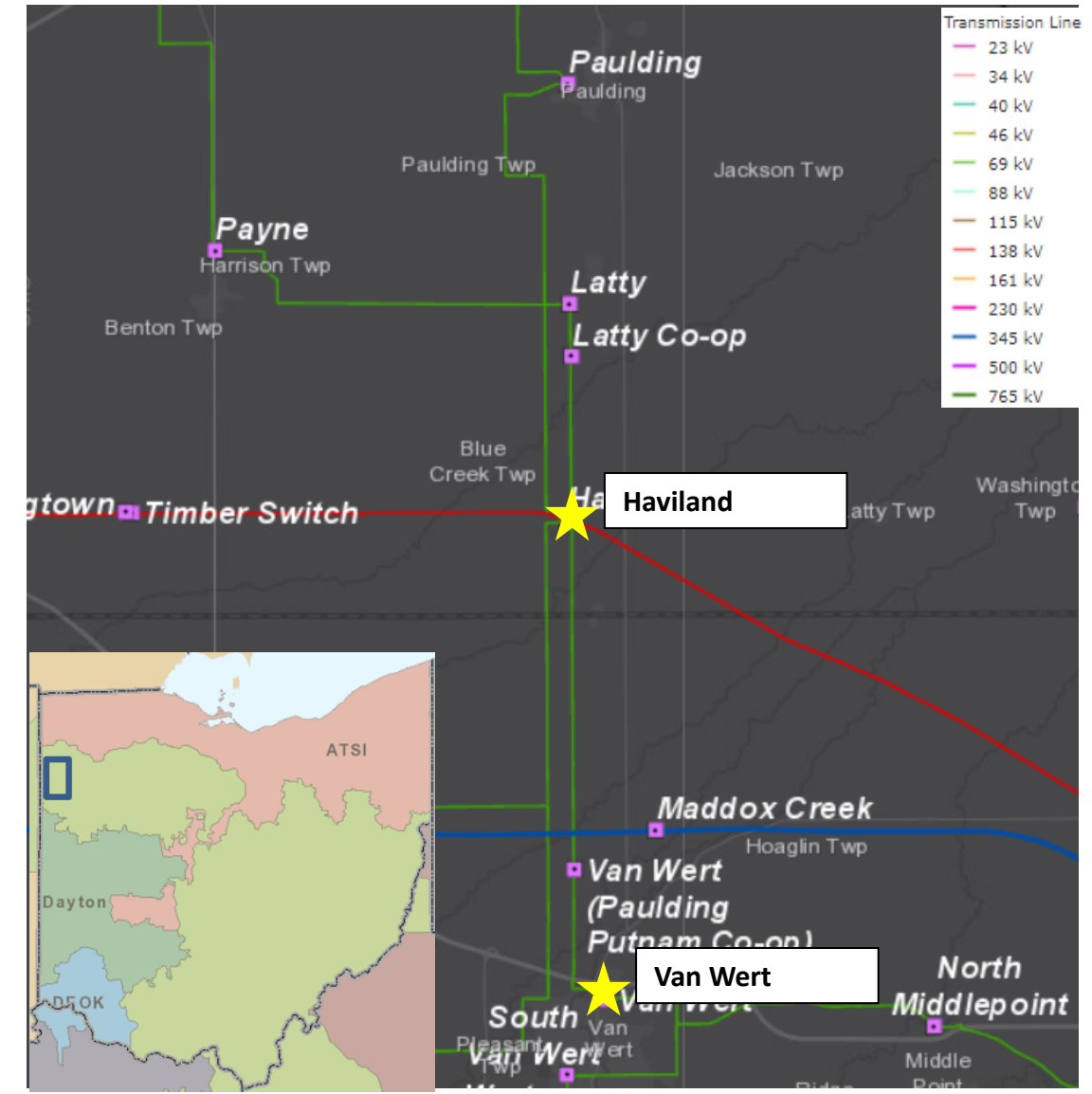

Need Number: AEP-2022-OH043

Process Stage: Submission of Supplemental Project for inclusion in the Local Plan 2/20/2024

Problem Statement continued:

- 15 structures were further assessed by a ground crew. 73% of those structures had reported conditions, which included the following: one structure had PLP deadends in the shield wire, one structure had pole top decay and a twisted crossarm, one structure had pole top decay, a PLP splice in the shield wire, brown porcelain tie-top post insulators with aluminum bases (failure risk) and an insulator with broken skirts, one structure had insect damage to a crossarm, a twisted crossarm, spliced conductors, a PLP splice in the shield wire and a 2-pole brace structure with a bent anchor, one structure had a compression splice in the shield wire, one structure had a stolen "S" downlead, one structure had brown porcelain tie-top insulators (failure risk), one structure had crossarm splitting and rotting, one structure had un-guyed distribution primary lateral that is deflecting the pole, one structure had a distribution secondary that is deflecting the pole and one structure had a PLP splice in the shield wire.

Additional Information:

During the 2012 Derecho and 2017 straight-line wind storms Van Wert- Haviland experienced multiple cascading pole failure events. These failed structures were replaced with steel monopole type structures. There are 55 newer steel structures, representing 22% of the structures on the line.

AEP Transmission Zone M-3 Process Paulding & Van Wert Co., OH

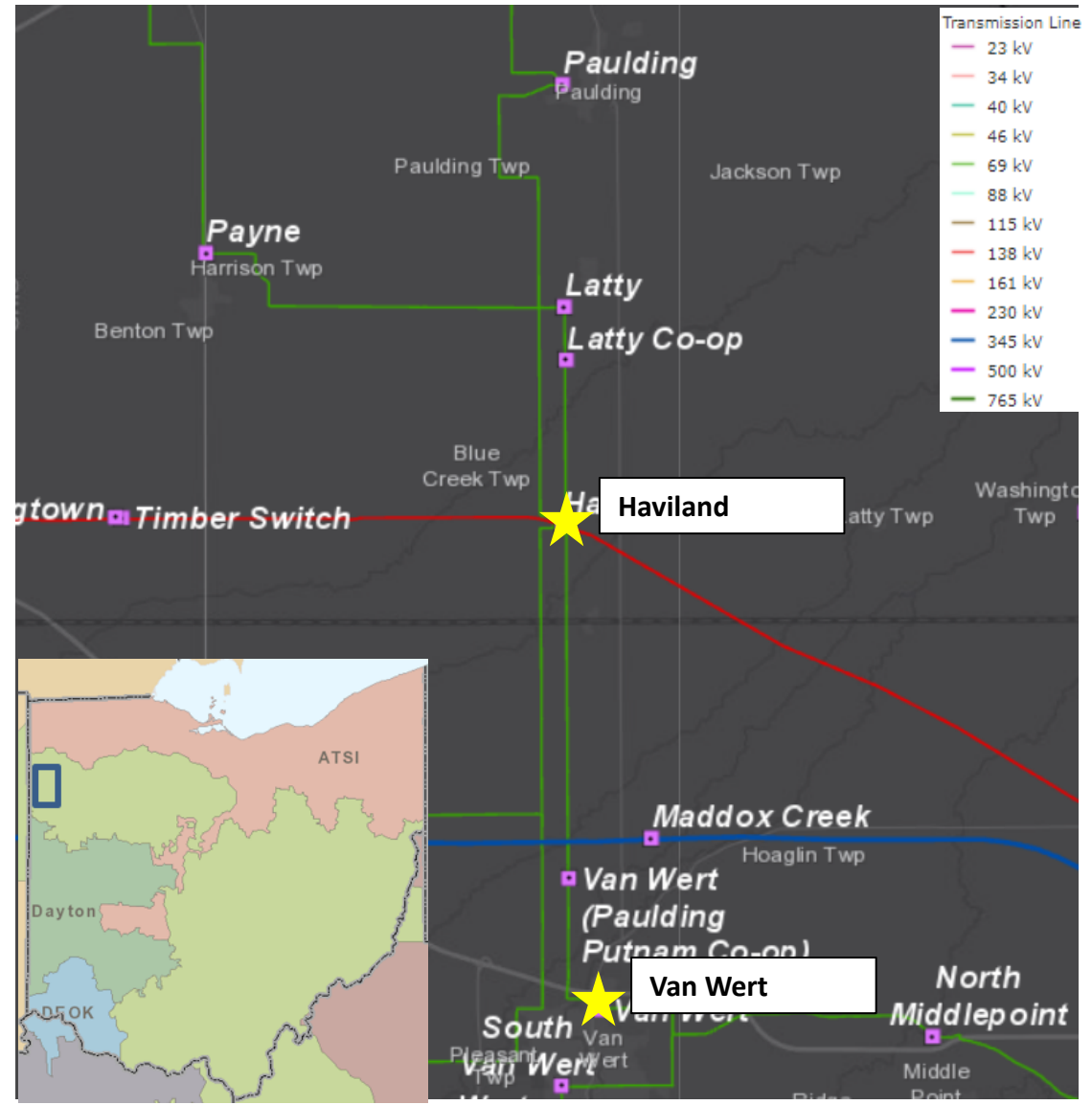

Need Number: AEP-2023-OH065

Process Stage: Submission of Supplemental Project for inclusion in the Local Plan 2/20/2024

Previously Presented:

Solution Meeting 10/20/2023

Need Meeting 04/21/2023

Project Driver:

Customer Service

Specific Assumption Reference:

AEP Guidelines for Transmission Owner Identified Needs (AEP Assumptions Slide 12)

Problem Statement:

Van Wert Mega Site:

The Van Wert Mega industrial site is located north of Van Wert in Van Wert County Ohio. The site is approximately one mile east of AEP's Van Wert - Haviland 69kV circuit. The site has been heavily targeted by regional and state economic development efforts and will continue to be. The site is highlighted by JobsOhio and its partner Regional Growth Partnership as its top available property for EV manufacturing. From January 2022 to March 2023 AEP Economic Development has had 32 requests for electric service plans at the site. The prospective customer's electric demand ranged from 5MW to 760MW. Around the industrial site, significant investment has been performed to prepare the site for manufacturing industry development, including installation of a rail spur.

Many of these prospective customers cannot be connected to the existing Van Wert area 69kV network without significant upgrades.

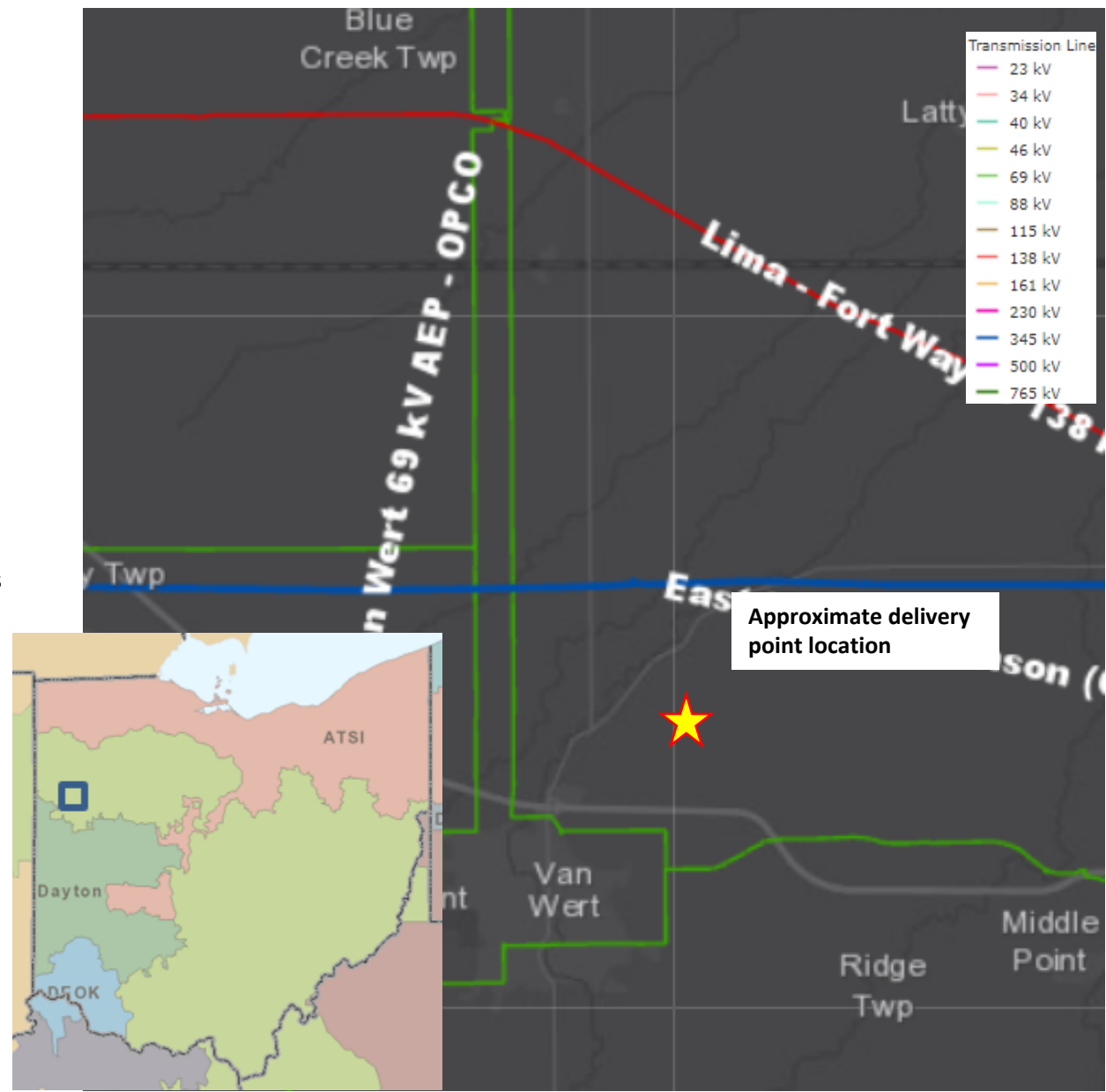

Need Number: AEP-2022-OH043, AEP-2023-OH065

Process Stage: Submission of Supplemental Project for inclusion in the Local Plan 2/20/2024

Solution:

Haviland - Van Wert: Rebuild the line to double circuit 138kV design using 1033 Curlew ACSR conductor. The line will be six wired and operated at 69kV. The rebuild will include a 2.6-mile greenfield section to route the line near several new industrial sites. The overall line length will be 10.8 miles. Newer installed poles will be re-used elsewhere. **Estimated Cost \$27.8M (s3142.1)**

Modify the b3359 scope from single circuit 69kV construction to double circuit 1033 Curlew at 138kV design **Estimated Cost \$2.89M (s3142.2)**

Perform remote end work at Haviland **Estimated Cost \$1.03M (s3142.3)**

Perform remote end work at Van Wert **Estimated Cost \$0.635M (s3142.4)**

Upgrade telecom equipment at South Van Wert, Logtown, Maddox Creek, Timber Switch and North Delphos stations **Estimated Cost \$0.194M (s3142.5)**

Total Estimated Transmission Cost: \$32.57M

Ancillary benefits:

- Upgrading the maximum possible line voltage with double circuit construction allows flexibility for future Van Wert area projects. The proposed solution can be used as part of the service plan for loads at the Van Wert Mega site with less greenfield construction. The Van Wert area does not currently have facilities greater than 69kV. This 138kV double circuit design allows AEP to use the exiting ROW to establish a new 138kV path to the load site. In the future, the circuits could be split and operated independently to support planning needs, load growth or operational concerns while maintaining the 69 kV network.

Model: PJM 2027 RTEP

Projected In-Service: 1/1/2026

Supplemental Project ID: s3142.1-.5

Project Status: Scoping

Existing

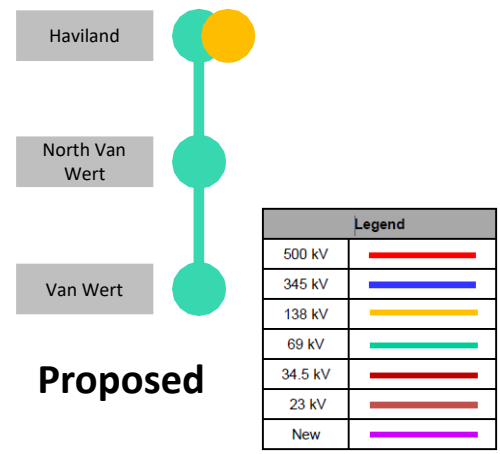

Proposed

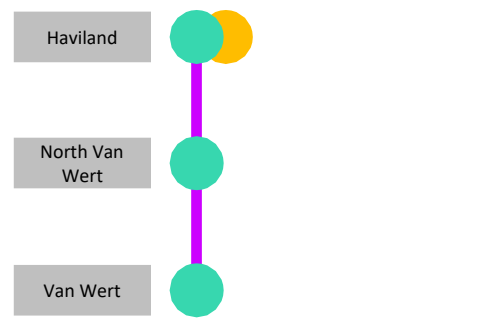

Need Number: AEP-2022-AP014

Process Stage: Submission of Supplemental Project for inclusion in the Local Plan 2/20/2024

Previously Presented:

- Solutions Meeting 10/3/2023
- Needs Meeting 2/18/2022

Supplemental Project Driver: Customer Service

Specific Assumption References: AEP Connection Requirements for the AEP Transmission System (AEP Assumptions Slide 12)

Problem Statement:

A new industrial customer has requested service near Apple Grove, WV by the end of ~~2024~~ 2025.

Projected load: 450 MW



Need Number: AEP-2022-AP014

Process Stage: Submission of Supplemental Project for inclusion in the Local Plan 2/20/2024

Solution Phase 1:

- Cut in/out of the existing Sporn – Tri-State 345 kV line and construct two single circuit 345 kV line extensions to a new 345 kV Station (Mercers Bottom) **Estimated Trans. Cost: \$19.7M (s3143.1)**
- Construct a new 345 kV Station (Mercers Bottom) with 8 - 5000 A, 63 kA circuit breakers **Estimated Trans. Cost: \$30.8M (s3143.2)**
- Remote end station work required at Sporn 345 kV **Estimated Trans. Cost: \$0.8M (s3143.3)**
- Construct two single circuit 345 kV feeds, approximately 0.75 miles each from Mercers Bottom 345 kV Station to the customer’s 345 kV Station. **Estimated Trans. Cost: \$12.4M (s3143.4)**
- Cut into the existing Apple Grove – South Point 138 kV line and install a new 3-way Phase over Phase switch. Install a single circuit 0.1 mi 138 kV extension to the customer station. Install 138 kV metering at the new switch. **Estimated Trans. Cost: \$7.1M (s3143.5)**

Phase 1 Estimated Transmission Cost: \$70.8M

AEP Transmission Zone: Supplemental Apple Grove, WV

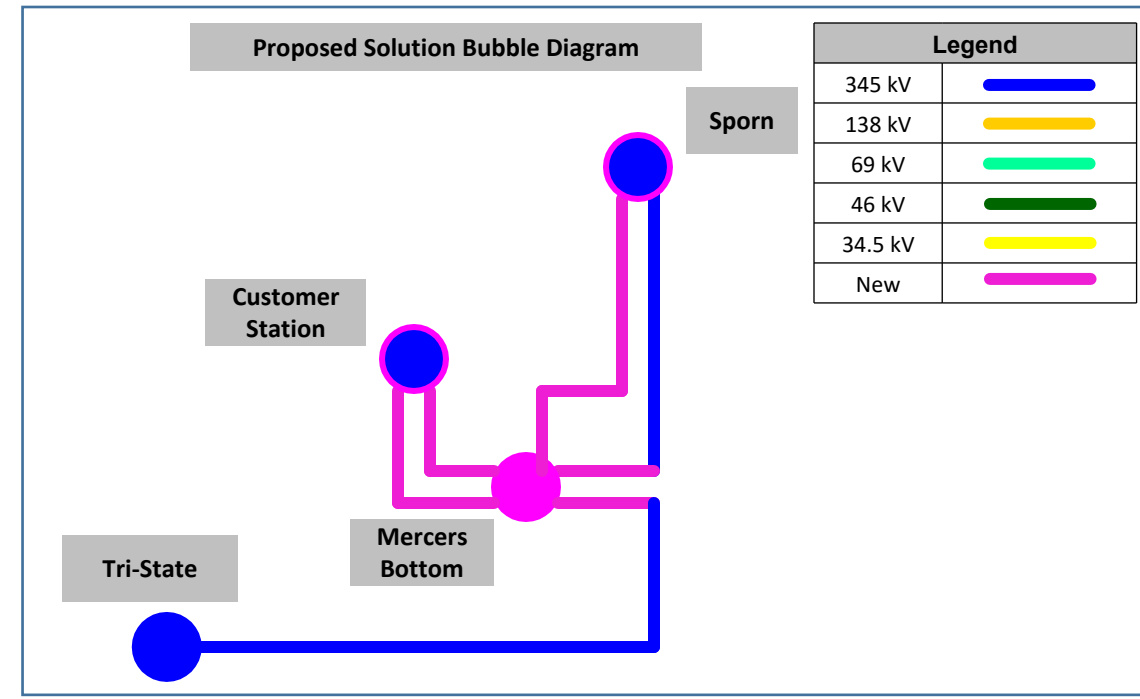
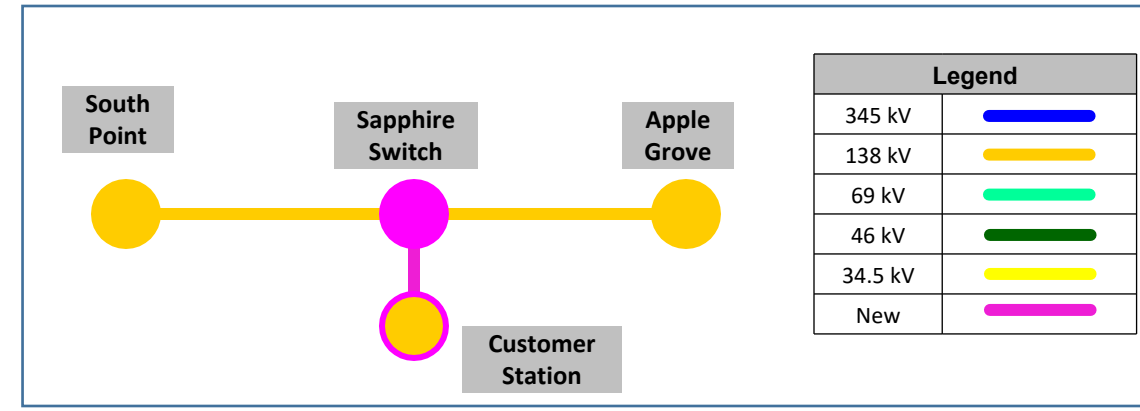

Need Number: AEP-2022-AP014

Process Stage: Submission of Supplemental Project for inclusion in the Local Plan 2/20/2024

Solution Phase 2:

- In order to meet the required short circuit strength needs of the customer under N-1 scenarios, construct a new 345 kV line from Sporn 345 kV Station to Mercers Bottom 345 kV Station, approximately 26 miles. **Estimated Trans. Cost: \$143.0M (s3143.6)**
- Install a new 345 kV circuit breaker at Sporn to accommodate the new 345 kV line. **Estimated Trans. Cost: \$2.0M (s3143.7)**

Phase 2 Estimated Cost: \$145M

Total Estimated Transmission Cost: \$215.8M

Projected In-Service: Phase 1 – 12/15/2025, Phase 2 – 12/15/2029

Supplemental Project ID: s3143.1-.7

Project Status: Scoping

AEP Transmission Zone: Supplemental Apple Grove, WV

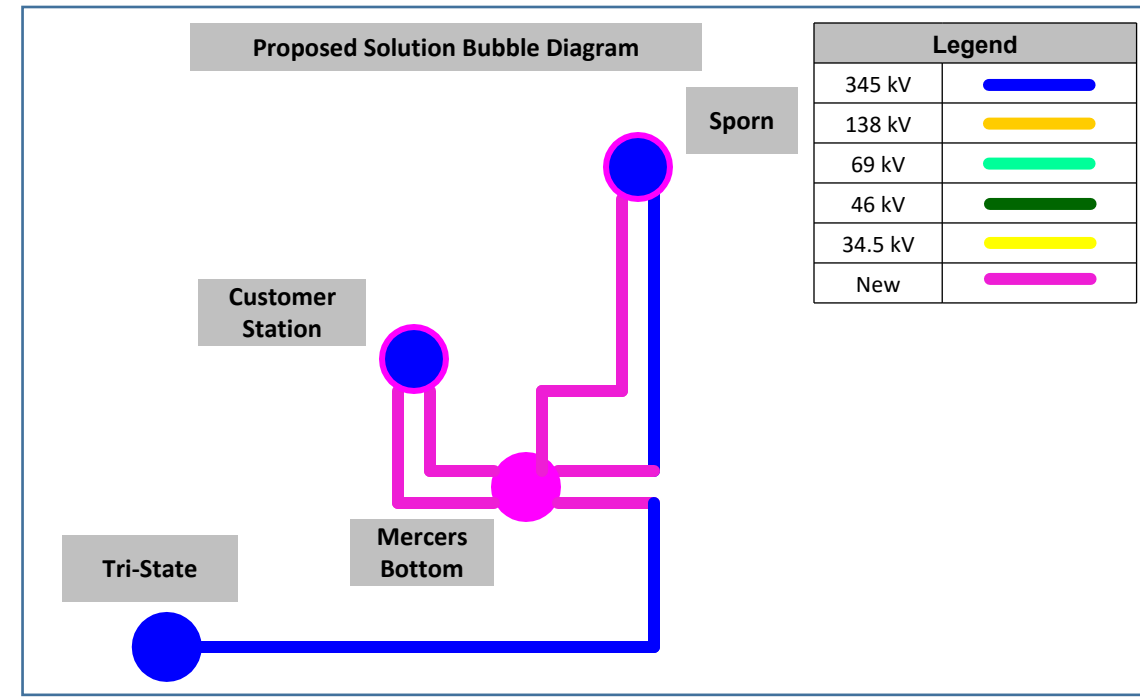
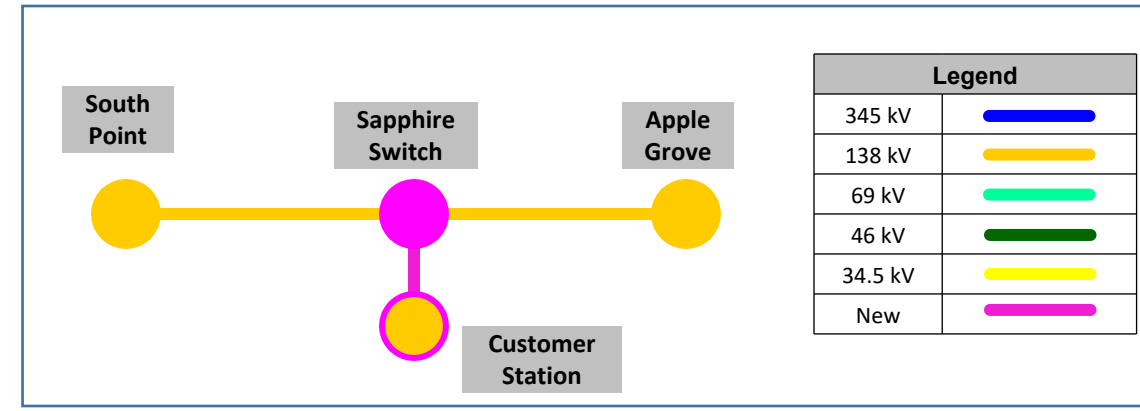

AEP Transmission Zone M-3 Process Lancaster Area Improvements

Need Number: AEP-2021-OH027

Process Stage: Submission of Supplemental Project for inclusion in the Local Plan 2/20/2024

Previously Presented:

Solutions Meeting 11/17/2023

Need Meeting 05/21/2021

Project Driver: Equipment Condition/Performance/Risk

Specific Assumption Reference: AEP Guidelines for Transmission Owner Identified Needs (AEP Assumptions Slide 13)

Problem Statement:

West Lancaster Station

Circuit Breakers: D & E (138 kV)

- Breaker Age: 1991: D & E
- Interrupting Medium: (SF6)
- Fault Ops: D: 40 & E: 8 (Manufactured recommended number of fault ops is 10)
- Additional Info: This type of breaker has had 411 malfunction records (mostly gas leaks and contact resistance concerns) and most problems reported with loss of SF6 and miss-operations.

Circuit Breakers: C & J (69 kV)

- Breaker Age: 1966: C & 1963: J
- Interrupting Medium: (Oil)
- Fault Ops: C: 87 & J: 5 (Manufactured recommended number of fault ops is 10)

Additional Info: These breakers are McGraw-Edison CF/CG/CGH/CH family of oil filled breakers without oil containment; Oil filled breakers have much more maintenance required due to oil handling that their modern, SF6 counterparts do not require. This model family has experienced major malfunctions associated with their OA-3 hydraulic mechanism, which includes low-pressure readings, hydraulic leaks, pump lockouts, and failure to shut off. These mechanism malfunctions have led to several failures to close and other types of mis-operations across the AEP fleet.

Circuit Switcher: BB (69 kV)

- Switcher Age: 1989
- Interrupting Medium: (SF6)
- Additional Info: This switcher is a Mark V type that has no gas monitor and currently in-service units on the AEP system have experienced 110 malfunctions from May 2000 to August 2019. Failed operational components including high contact resistance, gas loss, and interrupter failure represent half of these malfunctions. Two malfunctions of note were catastrophic equipment failures involving failures to trip.



Need Number: AEP-2021-OH027

Process Stage: Submission of Supplemental Project for inclusion in the Local Plan 2/20/2024

Problem Statement Continued:

West Lancaster - continued

138/69kV Transformer 2 (60 MVA)

- Age: 1966
- Overheating events indicate decomposition of the paper insulation that impairs the unit’s ability to withstand future short circuit or through fault.
- No oil containment.
- High side disconnect switches need replaced.
- Additional Info.: Currently no sectionalizing on either side of Transformer 1 & 2, there are three dissimilar zones of protection (138 kV Bus, Transformer & 69 kV Bus) .

Relaying:

Currently, 40 of the 74 relays (54% of all station relays) are in need of replacement. There are 38 of the electromechanical type and 2 of the static type which have significant limitations with regards to fault data collection and retention. These relays lack vendor support and have little to no access to spare parts.

Control House:

- Asbestos on walls, roof and cables
- Structural Integrity is in question – this needs replaced as soon as possible.
- Relays systems are not set up for dual battery configuration
- Cable entrance is 100% full

AEP Transmission Zone M-3 Process Lancaster Area Improvements



Need Number: AEP-2020-OH026, AEP-2021-OH026, AEP-2021-OH027

Process Stage: Submission of Supplemental Project for inclusion in the Local Plan 2/20/2024

Solution:

Ralston - North Logan 69 kV Line : Retire the line section between North Logan – Geneva Switch (~9.0 miles) between Str. 70 – 147 and rebuild a portion as double circuit from Geneva Sw up to Str. 70/71 (~1.15 miles). Cost: \$9.67M (**s3133.1**)

East Logan – Shawnee 69 kV Line : Six-wire the 69 kV line between N. Logan – E. Logan (Str. 2-43) and terminate the E. Logan – New Lexington 69 kV circuit into the now vacated Ralston – N. Logan 69 kV line position at N. Logan station at/near structure 44 to form the new N. Logan – New Lex. 69 kV circuit. Remove sections between Str. 43 – 44 and Str. 2 – E. Logan (CB-L). Cost: \$1.28M (**s3133.2**)

Clouse - West Lancaster 138 kV: Rebuild ~23 miles of 138 kV line between West Lancaster and Clouse stations. The existing double circuit line will be rebuilt as double circuit between West Lancaster and just east of South Lancaster station along with the section between structure 96 and Clouse station. The remaining ~5.6 miles of the line will be rebuilt as single circuit. The section between structure 96 and Clouse will have one circuit of the double circuit operated at 69 kV to form the South Lancaster – Clouse circuit to allow for the retirement of the Ralston – North Logan line south. 69 kV and 138 kV line extensions will be installed into Clouse station, using 795 ACSR conductor SE 360 MVA. Cost: \$65.81M (**s3133.3**)

East Logan – South Lancaster 69 kV Line : Re-terminate this line at East Logan to utilize CB-P, which is a newer vintage breaker in better health than existing breaker M. Cost: \$0.72M (**s3133.4**)

East Logan 69 kV: Retire 69 kV CB-M and repurpose CB-P for re-terminating the South Lancaster circuit. Cost: \$0.77M (**s3133.5**)

Clouse 138 kV & 69 kV: Add a 138 kV, 3000 A, 63 kA breaker to accommodate the new 138 kV line from Crooksville. Add a 69 kV, 3000 A, 40 kA breaker to accommodate the new 69 kV line from South Lancaster (thru Geneva Sw). Install all associated attachment facilities. DICM expansion will likely be required. Cost: \$1.67M (**s3133.6**)

Geneva Sw 69 kV: Replace & relocate the existing PoP Switch with a 3-way 1200A PoP Switch. Cost: \$0.95M (**s3133.7**)

Junction City 138 kV: Replace the existing 2-way POP with a 3-way 2000A POP. Cost: \$1.15M (**s3133.8**)

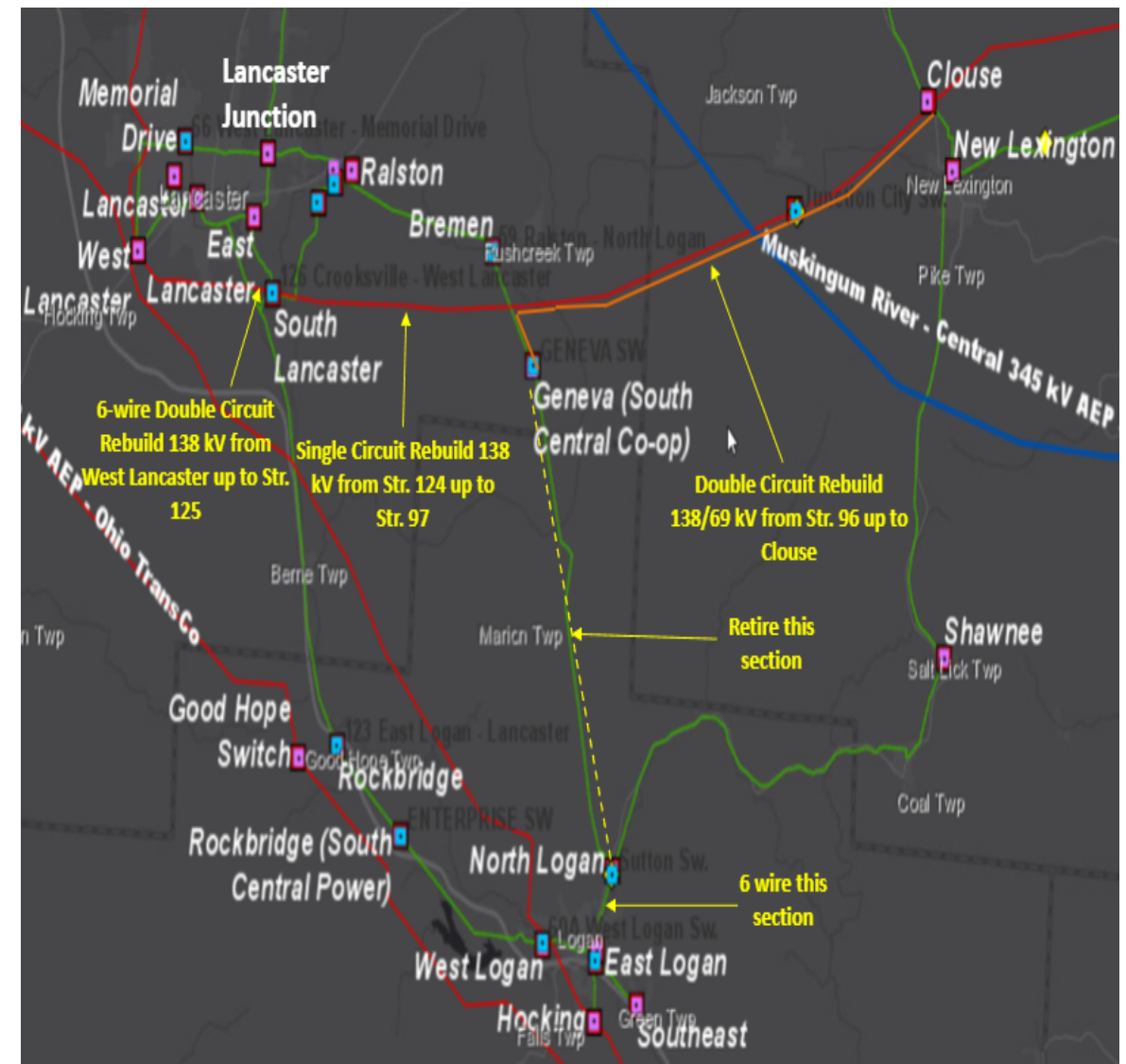

AEP Transmission Zone M-3 Process Lancaster Area Improvements

Need Number: AEP-2020-OH026, AEP-2021-OH026, AEP-2021-OH027

Process Stage: Submission of Supplemental Project for inclusion in the Local Plan 2/20/2024

Solution Continued:

West Lancaster 138 kV & 69 kV: Replace T2 with a 90MVA bank. Replace 138 kV CB-D with 1 - 138 kV, 3000 A, 40 kA circuit breaker, 69 kV CB-C & CB-J with 2 – 69kV 3000 A, 40 kA circuit breakers, 69 kV CS-BB with 1 – 69 kV 2000A 31.5 kA circuit breaker and, the control building with DICM & new relays. Retire 138 kV CB-E. Replace 69 kV Bus 1 PT's. Cost: \$10.83M. **Note: Work will be coordinated with previously proposed upgrades at station captured under S2857.9. (s3133.9)**

South Lancaster 138 kV & 69 kV: Add 2 - 69 kV, 3000 A, 40 kA and 2- 138 kV, 3000 A, 40 kA circuit breakers to the low and high sides of T1 and T2. Upgrade transformers' protection. Cost: \$3.22M **(s3133.10)**

Lancaster – E. Lancaster – S. Lancaster 69 kV: In order to mitigate the 3-terminal line, 0.2 miles of 69 kV double circuit line, including several dead end and turning structures, will be constructed to loop the circuit into East Lancaster station. Cost: \$2.39M **(s3133.11)**

East Lancaster 69 kV: Extend the bus to accommodate a new line. Install one new 69 kV, 3000 A, 40 kA breaker and all associated attachment facilities (relays, bus work, risers, and switches). Retire the 69 kV cap bank. Cost: \$1.04M **(s3133.12)**

Lancaster Jct – E. Lancaster – Ralson 69 kV : In order to mitigate the 3-terminal line, 0.2 miles of 69 kV double circuit line will be constructed to loop the circuit into Lancaster Junction station. There will be associated telecom work performed as well. Cost: \$1.65M **(s3133.13)**

Lancaster Junction 69 kV: Add three 69 kV, 3000 A, 40 kA line breakers at Lancaster Junction and all associated attachment facilities (relays, bus work, risers, and switches). Expand the Station to include two box bays. Retire 69 kV Line & Bus tie switches. Cost: \$5.03M **(s3133.14)**

Anchor Hocking, Lancaster, North Logan, New Lexington 69 kV: Remote end PCE work will be performed to accommodate project in area. Cost: \$0.69M **(s3133.15)**

Total Estimated Transmission Cost: \$108.77

Projected In-Service: 04/25/2025

Supplemental Project ID: s3133.1-.15

Project Status: Engineering

Model: 2028 RTEP

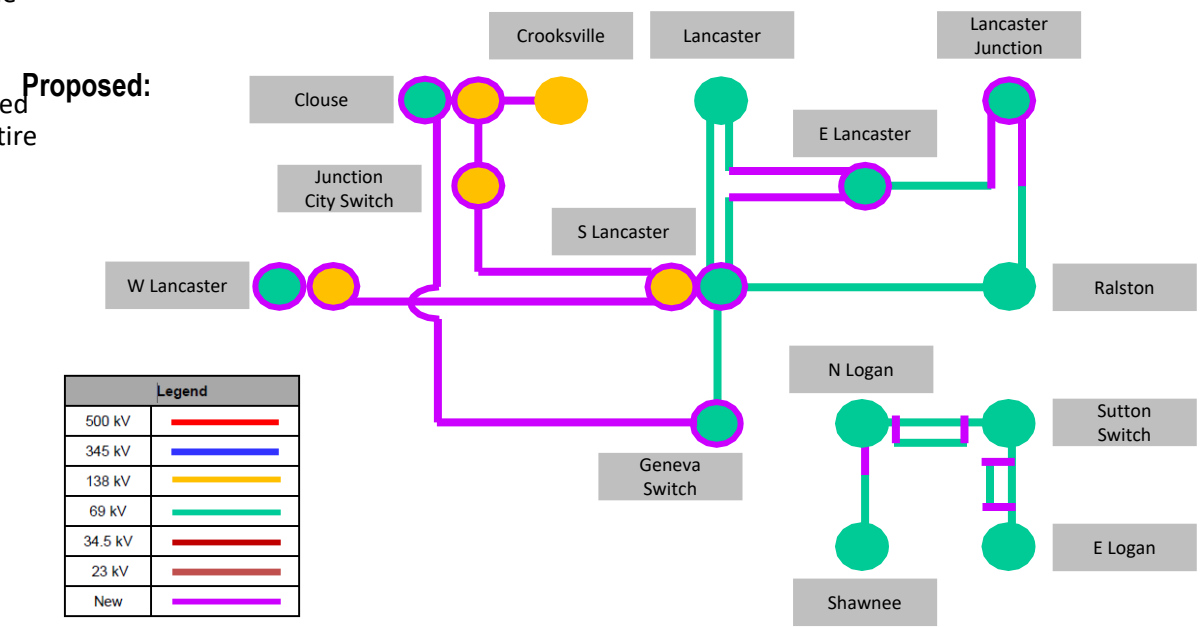
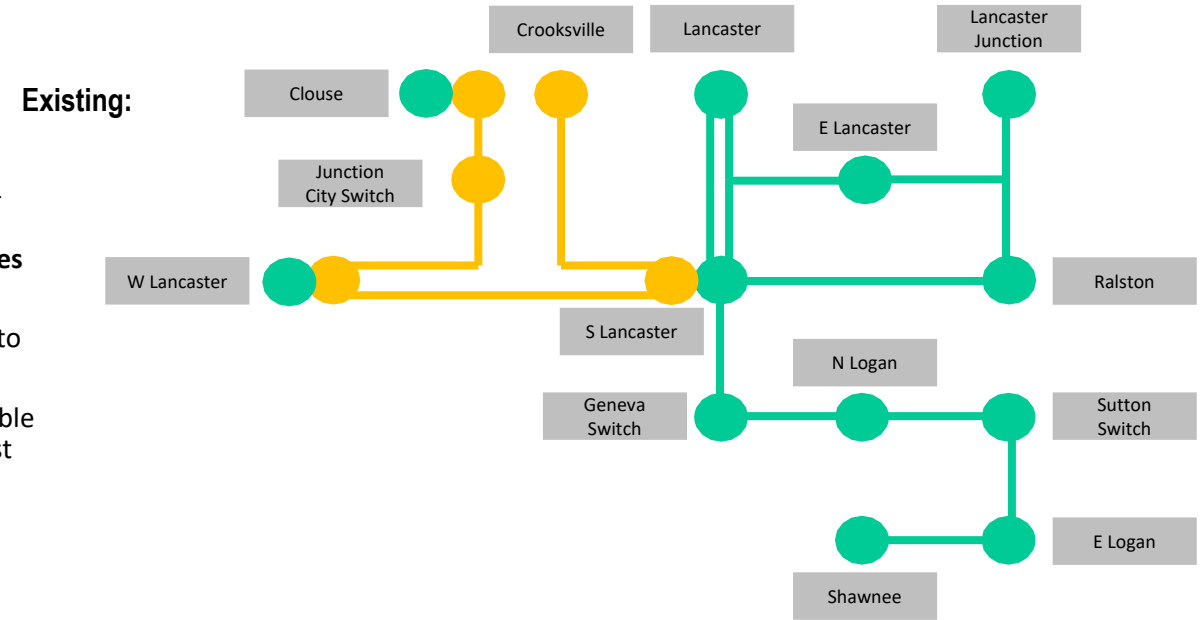

Need Number: AEP-2021-AP009

Process Stage: Submission of Supplemental Project for inclusion in the Local Plan 2/20/2024

Previously Presented:

- Solutions Meeting 11/17/2023
- Needs Meeting 3/19/2021

Supplemental Project Driver: Customer Request

Specific Assumptions Reference: AEP Connection Requirements for the AEP Transmission System (AEP Assumptions Slide 12)

Problem Statement:

- A customer has requested service for the establishment of a new distribution station located at the Wildwood Commerce Park site in Hillsville, VA.
- This station is the result of VA House Bill 1840 (HB1840) (Electric Utilities: Pilot Programs for Transmission Facilities Serving Business Parks).

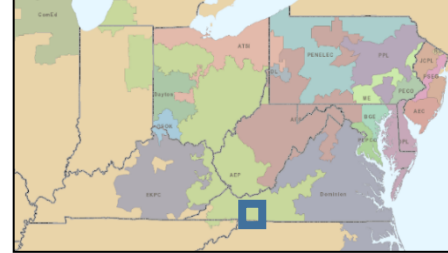
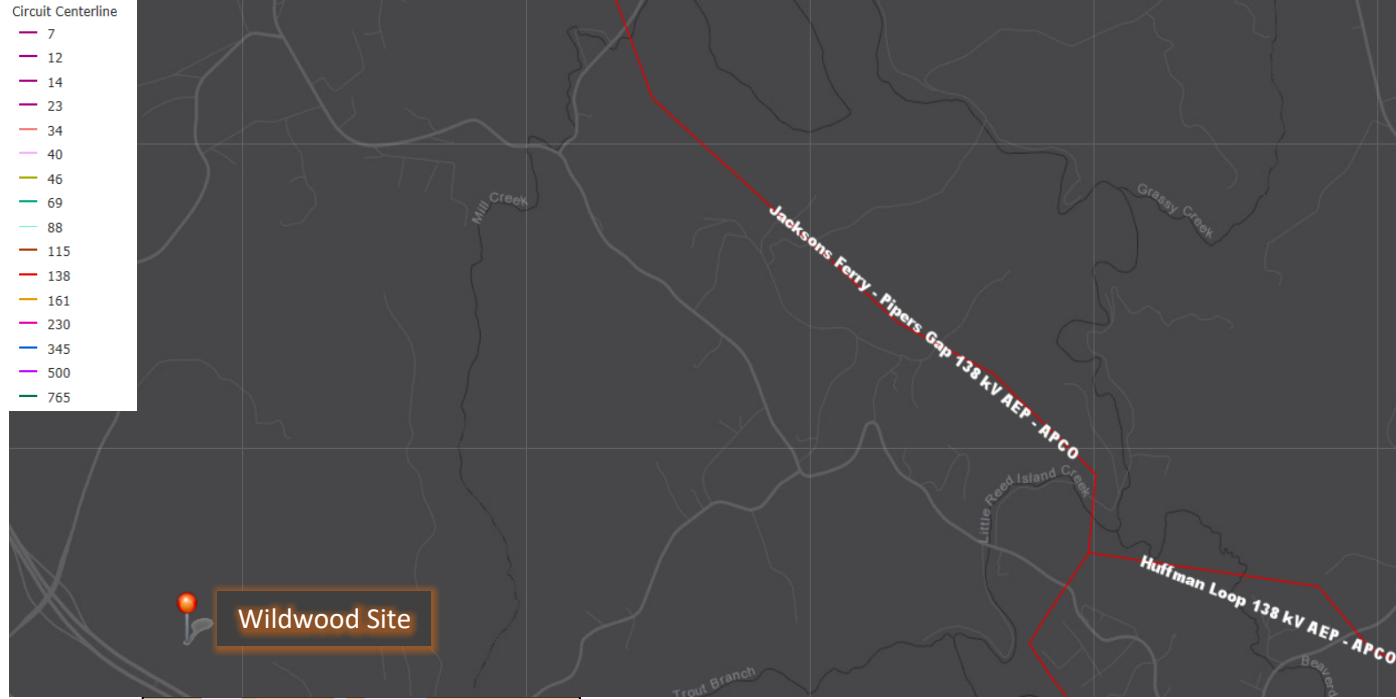
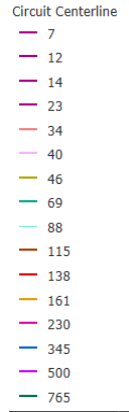

Need Number(s): AEP-2021-AP009

Process Stage: Submission of Supplemental Project for inclusion in the Local Plan 2/20/2024

Solution:

Wildwood 138 kV Station (\$0 M - Distribution) (s3134.1)

- Construct a 138 kV straight bus with 2 MOABs that are SCADA controlled
- Install a 138/34.5 kV, 30 MVA Distribution transformer with two 34.5kV circuit breakers

Wildwood 138 kV Extension (\$20.8M) (s3134.2)

- Install a new 138kV 3 pole custom tap structure on the Jacksons Ferry – Huffman 138 kV circuit. Construct approximately 4.0 miles of new double circuit 138 kV line with OPGW from the tap location to the new Wildwood substation. The higher cost is due to access road and restoration costs in the state of Virginia. The right of way for this 138kV extension travels in different directions due to hard to obtain easements causing higher line cost. Install ADSS fiber along existing Huffman-Jacksons Ferry line.

Estimated Total Transmission Cost: \$20.8 M

Ancillary Benefits:

Establishing a new 138 kV station near the Wildwood Commerce Park will allow for future interconnection opportunities and economic development in the area. This project is the result of VA House Bill 1840 (HB1840) (Electric Utilities: Pilot Programs for Transmission Facilities Serving Business Parks).

At present, AEP/APCO economic development and partners are supporting requests from prospective business inquiries to Wildwood Commerce Park. The Blue Ridge Crossroads Economic Development Authority is in late-stage negotiations with a prospective customer seeking to locate to Wildwood Commerce Park. This project is a confidential/unannounced prospective business opportunity, with initial demand needs forecasted to exceed available distribution system capacity upon completion/full buildout. This prospect is anticipated to make a public announcement in 2024; date for public announcement is pending completion of formal/final stage project review processes.

Projected In-Service: 11/15/2024

Supplemental Project ID: s3134.1-.2

Project Status: Engineering

AEP Transmission Zone M-3 Process Carroll County, VA

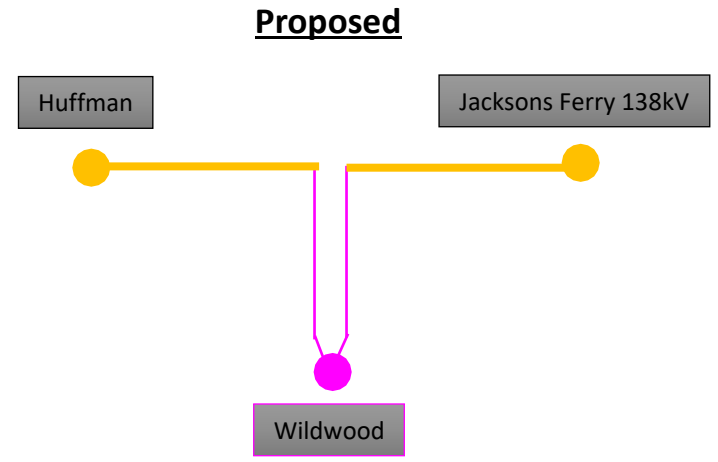

Legend	
500 kV	
345 kV	
138 kV	
69 kV	
34.5 kV	
23 kV	
New	

Need Number: AEP-2021-AP014

Process Stage: Submission of Supplemental Project for inclusion in the Local Plan 2/20/2024

Previously Presented:

Solutions Meeting 11/17/2023
Needs Meeting 03/19/2021

Supplemental Project Driver: Equipment Condition/Performance/Risk

Specific Assumption Reference:

Specific Assumption References: AEP Connection Requirements for the AEP Transmission System (AEP Assumptions Slide 12, 14)

Problem Statement:

Line Name: Garden Creek – Skeggs Branch – Richlands 69kV

Original Install Date (Age): 1935,1962,1970

Length of Line: ~21 mi

Total structure count: 180

Original Line Construction Type: Wood and Lattice Steel

Conductor Type: 3/0 ACSR 6/1 (Pigeon), 556,500 CM ACSR 26/7 (Dove), and 336,400 CM ACSR 30/7 (Oriole)

Momentary/Permanent Outages: 26 Momentary and 6 permanent Outages

CMI (last 5 years only): 0

Line conditions:

- 42 structures with at least one open structural condition, 23% of the structures on this circuit.
- 73 structure related open conditions impacting wooden poles, lattice steel towers, crossarms, braces, and filler blocks including rot, bowing, woodpecker holes, insect damage, cracked, split, and heavy rust/corrosion.
- 1 open conditions related to broken strands
- 8 hardware related open conditions related to broken or chipped insulators and a buried guy.

Other:

- This circuit is operated normally open at Permac station
- Lack of sectionalizing capability due to multiple stations (Twin Valley SS, Marvin, Clell) being hard tapped to 69kV Line or operated radially
- Whetstone Branch is a 3 terminal switching station with no 69 kV line breakers.
- Only 11.6 miles of this line are currently shielded.

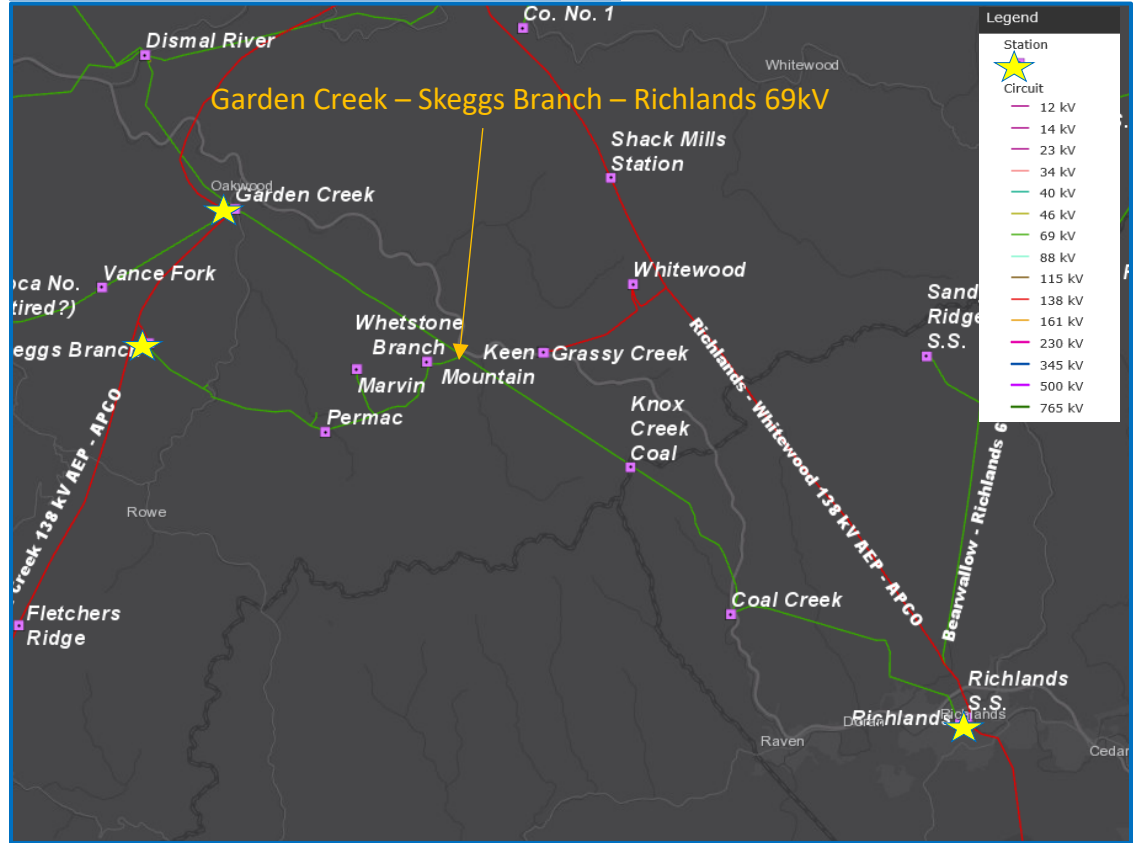
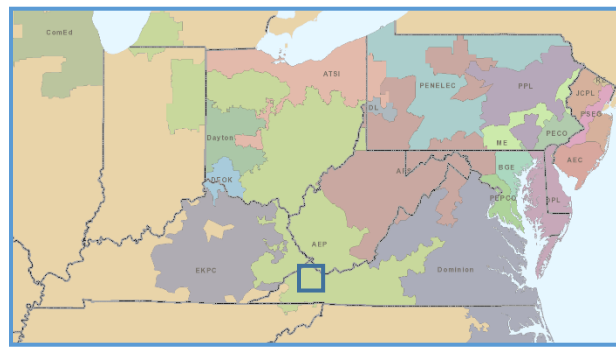

Need Number: AEP-2021-AP014

Process Stage: Submission of Supplemental Project for inclusion in the Local Plan 2/20/2024

Previously Presented: Needs Meeting 03/19/2021

Supplemental Project Driver: Equipment Condition/Performance/Risk

Solution:

- Rebuild ~2.6 mi portion of the existing Garden Creek - Richlands - Skeggs Branch 69kV Line from the existing Permac station to the existing tap structure 340-28 on the Garden Creek – Skeggs Branch - Richlands. Rebuild ~4.6 mi of the existing Garden Creek - Richlands - Skeggs Branch 69kV Line from the existing Coal Creek to Richlands substation. **Estimated Transmission Cost: \$27.2 M (s3135.1)**
- At Whetstone Branch Station, replace circuit switcher "AA" with a new, standard, 69kV circuit switcher, replace all metering CTs and PTs with CT/PT combo metering units, and replace the existing single phase CCVT with a new standard three phase CCVT. **Estimated Transmission Cost: \$1.55 M (s3135.2)**
- At Coal Creek substation, reconductor the 69kV bus, replace 600A Switchers with new MOAB switches on new steel structures. Switch "33" towards the customer will be replaced to allow for the new structure to fit into the existing station footprint. **Estimated Transmission Cost: \$0 M (s3135.3)**
- Remote end work at Richlands substation. **Estimated Transmission Cost: \$0.05 M (s3135.4)**
- Provide transition fiber on the Garden Creek - Richlands - Skeggs Branch 69kV Line for connectivity at Mount Heron Station and at Whetstone Branch Station to support CES networking and SCADA connectivity. **Estimated Transmission Cost: \$0.40 M (s3135.5)**

Total Estimated Transmission Cost: \$29.2 M

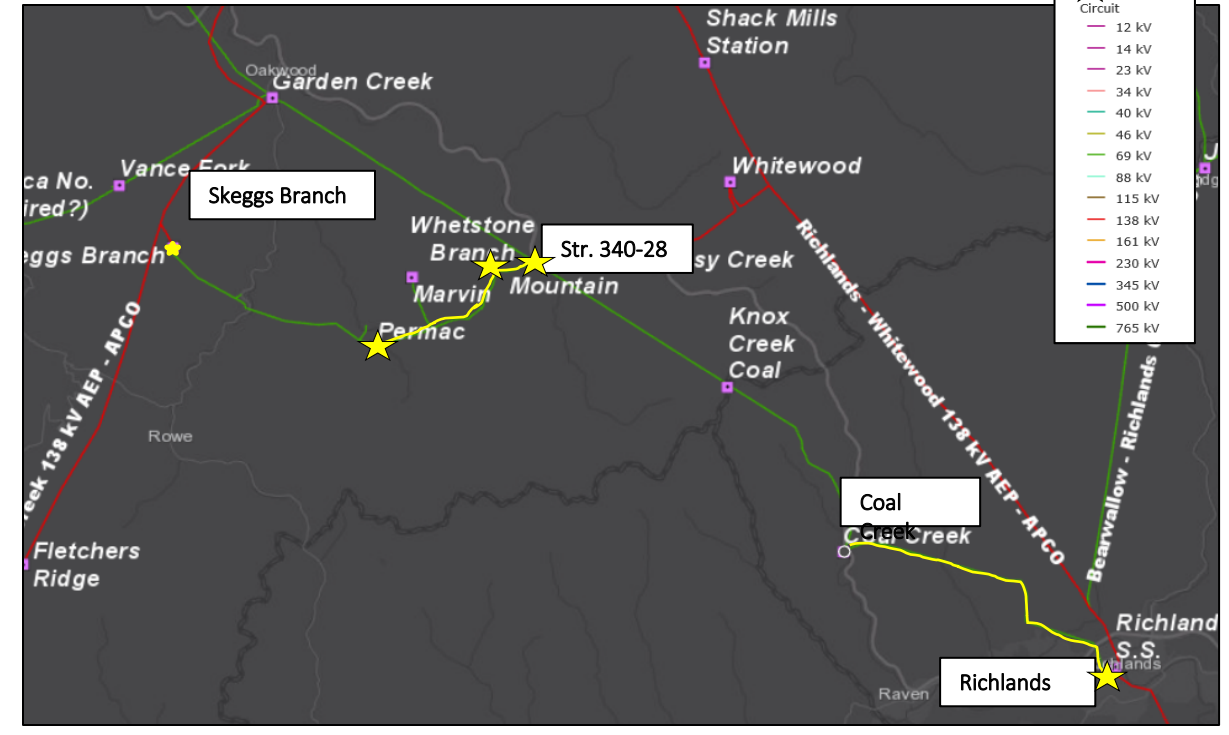
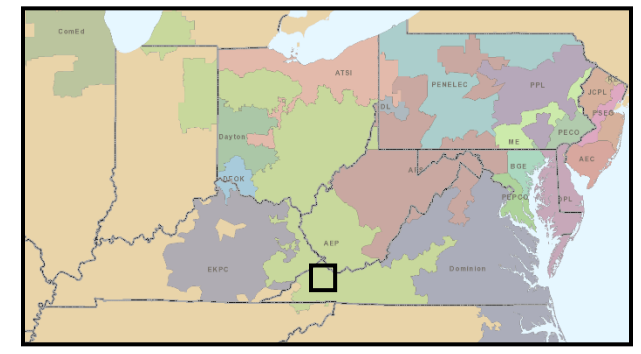



BOUNDLESS ENERGY™

Need Number: AEP-2021-AP014

Process Stage: Submission of Supplemental Project for inclusion in the Local Plan 2/20/2024

Previously Presented: Needs Meeting 03/19/2021

Supplemental Project Driver: Equipment Condition/Performance/Risk

Solution:

Ancillary Benefit:

In conjunction with B3333, which proposes to rebuild sections of Garden Creek - Skeggs Branch – Coal Creek line and retire part of the line, this project proposes to rebuild rest of the 69kV line and thus addressing remaining needs of AEP-2021-AP014.

Projected In-Service: 10/30/2027

Supplemental Project ID: s3135.1-.5

AEP Transmission Zone M-3 Process Buchanan County & Tazewell County, VA

Bubble Diagram (Existing)

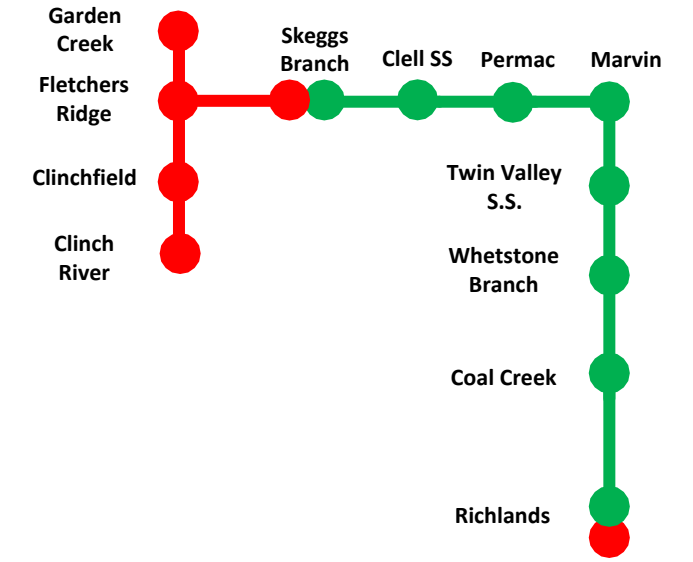

Bubble Diagram (Proposed)

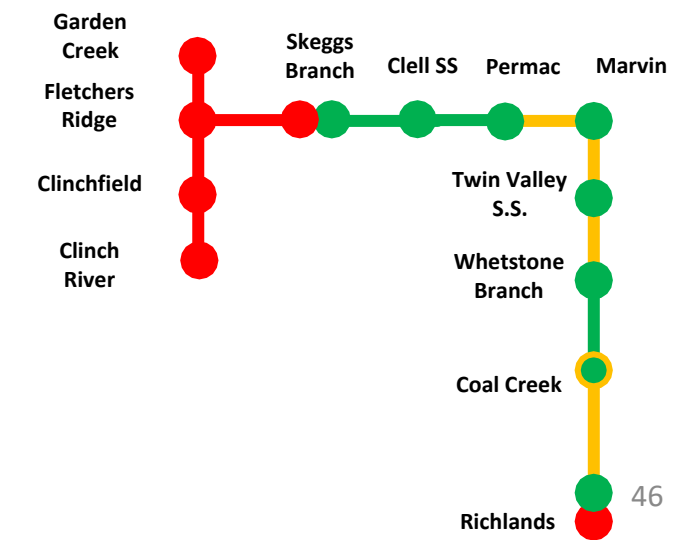

Legend	
345 kV	
138 kV	
69 kV	
46 kV	
New	

Need Number: AEP-2022-IM013

Process Stage: Submission of Supplemental Project for inclusion in the Local Plan 2/20/2024

Previously Presented:

Solution Meeting 11/17/2023

Needs Meeting 6/15/2022

Project Driver: Equipment Material Condition, Performance and Risk

Specific Assumption Reference: AEP Guidelines for Transmission Owner Identified Needs (AEP Assumptions slide 13)

Problem Statement:

Dowagiac Customer Growth

- The customer served from Rudy Tap 34.5kV Sw has requested a load increase.
- The customer has indicated a demand of 28MW at their existing delivery point with plans to expand and increase load significantly

AEP Transmission Zone M-3 Process Rothadew Area Improvements

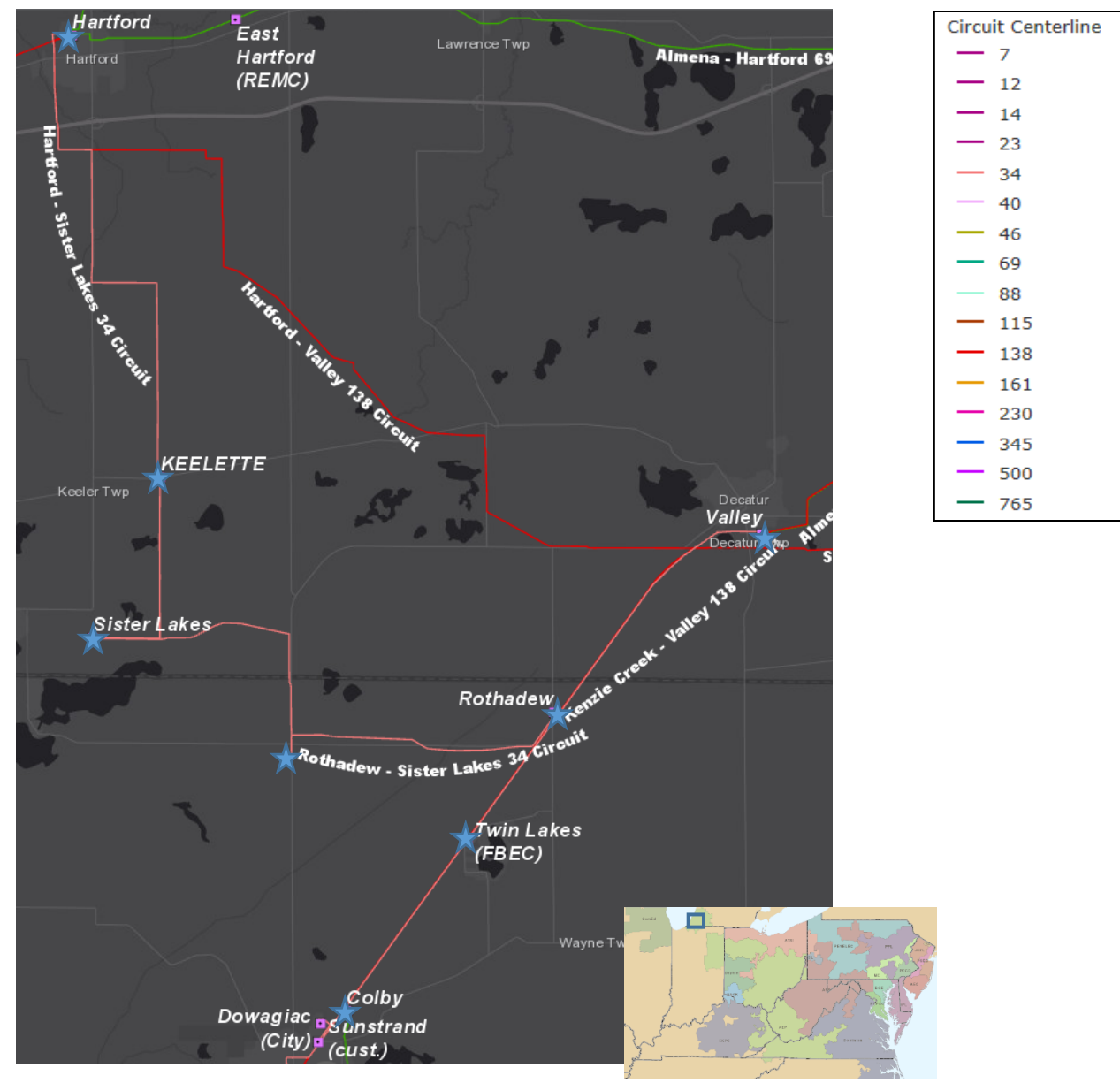

Need Number: AEP-2022-IM013

Process Stage: Submission of Supplemental Project for inclusion in the Local Plan 2/20/2024

Previously Presented:

Solution Meeting 11/17/2023

Needs Meeting 6/15/2022

Project Summary: With the 28MW load increase request at Dowagiac, there are several issues that arise on the existing 34.5 kV system under N-1-1 loss of both the transformers at Colby station that include the following:

- Rothadew – Twin Lakes 34.5kV loads to 123% of its summer emergency rating
- Colby – Twin Lakes 34.5kV loads to 121% of its summer emergency rating
- Hartford 138/69/34.5kV transformer loads to 203% of its summer emergency rating
- The 34.5kV area experiences low voltages at Keelette, Sister Lakes, Gearcon, Valley, Twin Lakes, Dowagiac, and Sunstrand with the lowest being 0.42 per unit

In order to address the issues listed above with the increased load, the best path forward would be to convert the area to 69kV. The majority of the lines in the area are already constructed to 69 kV standards; therefore, the scope of work required to convert to 69 kV is limited. The delivery point at Dowagiac is already configured to accommodate the 28 MW request.

Further, AEP is moving away from the 34.5kV transmission voltage class where there are issues with drop and pick operations. The 34.5kV voltage delivery points are out of phase from delivery at 69kV or 138kV and switching load from one 34.5kV source to another, higher voltage source requires the customers to be dropped and then picked up from the new source. Utilizing 69 or 138 kV as a standard delivery voltage eliminates the initial drop requirement for the load.

Existing

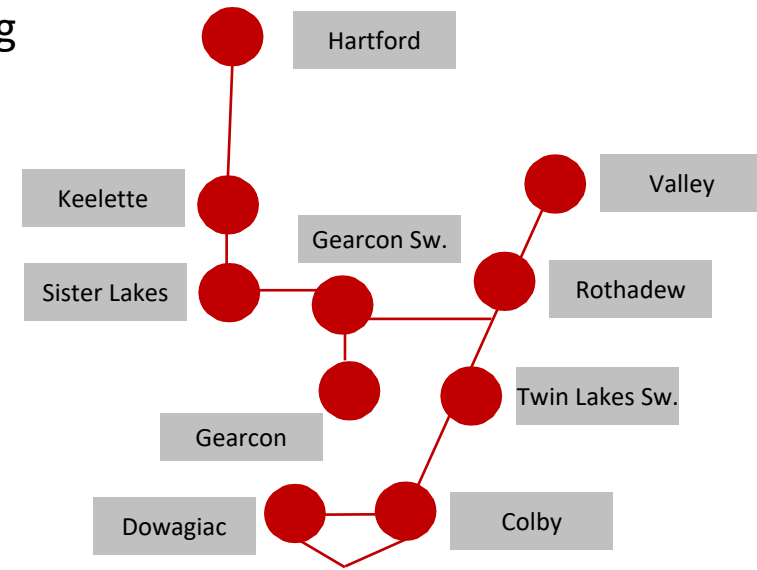

Proposed

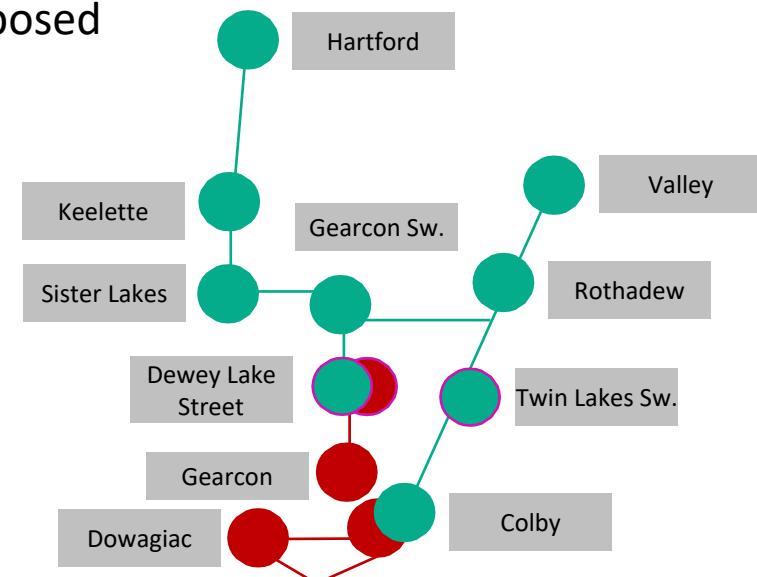

Legend	
500 kV	
345 kV	
138 kV	
69 kV	
34.5 kV	
23 kV	
New	

Need Number: AEP-2022-IM013

Process Stage: Submission of Supplemental Project for inclusion in the Local Plan 2/20/2024

Solution:

- **Hartford Station:** Install a 69kV breaker and remove the 34.5kV equipment. Station Service will be relocated closer to the transformer. **Estimated Transmission Cost: \$0.59M (s3136.1)**
- **Sister Lakes:** Replace both transformers with 9.375MVA 69/12kV units and install a high side switcher on transformer 1. **Estimated Transmission Cost: \$0M (s3136.2)**
- **Dewey Lake Street:** Install a new 7.5 MVA 69/34.5kV transformer with low side breaker and high side fuse. This will be located close to Gearcon Switch. **Estimated Transmission Cost: \$1.72M (s3136.3)**
- **Valley:** Install a 69/34.5kV 12.5MVA transformer and reterminate the Rothadew line to the 69kV bus. **Estimated Transmission Cost: \$3.63M (s3136.4)**
- **Colby:** Move the Rothadew line to the 69kV bus. **Estimated Transmission Cost: \$0.11M (s3136.5)**
- **Twin Lakes Sw.:** Replace Switch. **Estimated Transmission Cost: \$0.83M (s3136.6)**
- **Keelette, Sister Lakes, Gearcon Sw., Rothadew,:** Energize to 69kV. **Estimated Transmission Cost: \$1.01M (s3136.7)**

Total Estimated Transmission Cost: \$7.89M

Ancillary Benefits: Moving to 69kV will improve operational flexibility and eliminate the problem of the drop and pick issues that the 34.5kV voltage class experiences. Scope of work is limited due to lines already constructed to 69 kV design.

Projected In-Service: 7/27/2027

Supplemental Project ID: s3136.1-.7

Project Status: Scoping

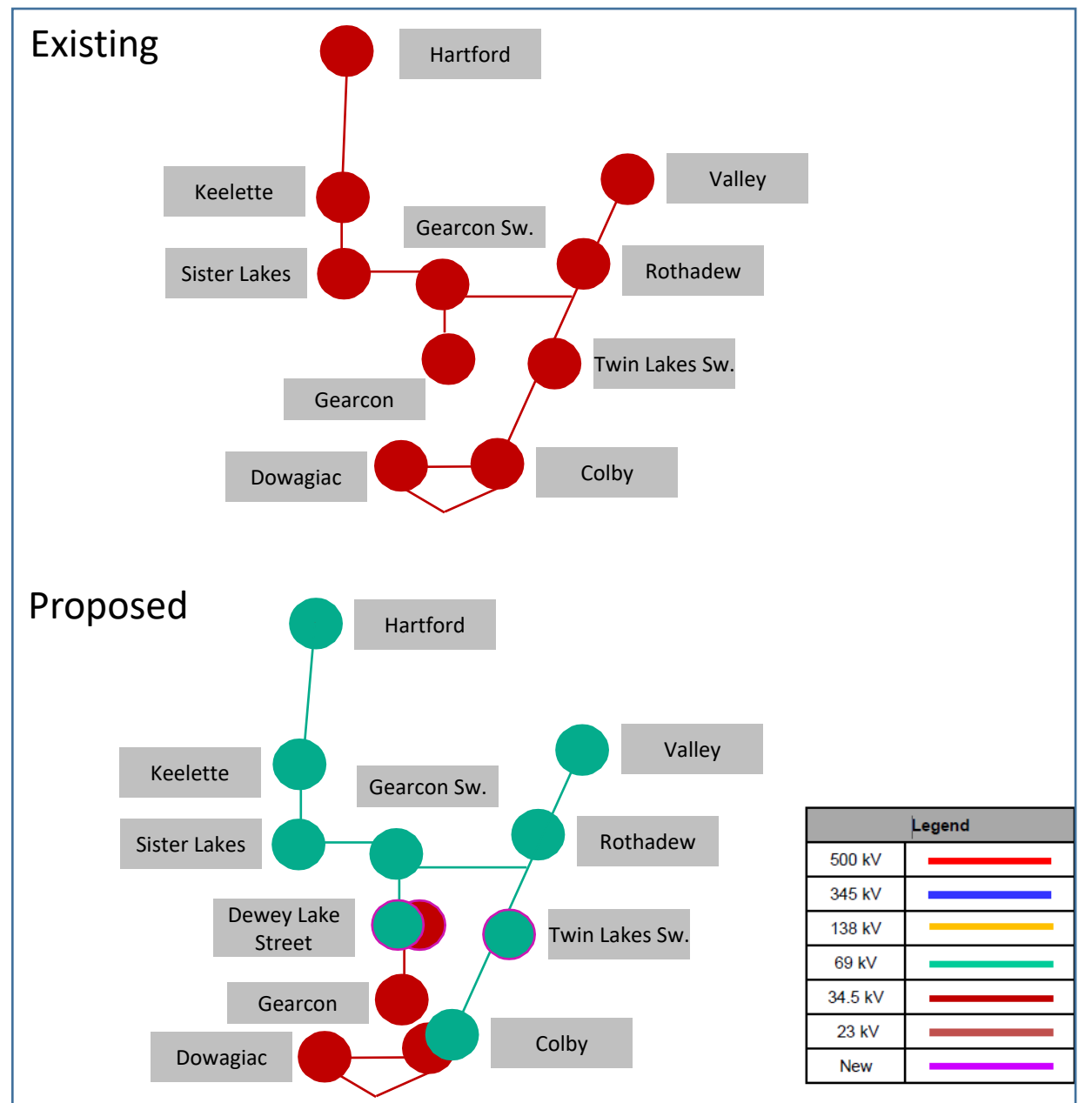

Need Number: AEP-2023-AP021

Process Stage: Submission of Supplemental Project for inclusion in the Local Plan 2/20/2024

Previously Presented:

- Solutions Meeting 11/17/2023
- Needs Meeting 8/18/2023

Supplemental Project Driver: Customer Service

Specific Assumption References: AEP Connection Requirements for the AEP Transmission System (AEP Assumptions Slide 12)

Problem Statement:

A new industrial customer has requested service in Jackson County, WV by the end of 2024.

Projected load: 30 MVA initial load, upwards to a maximum of 80 MVA

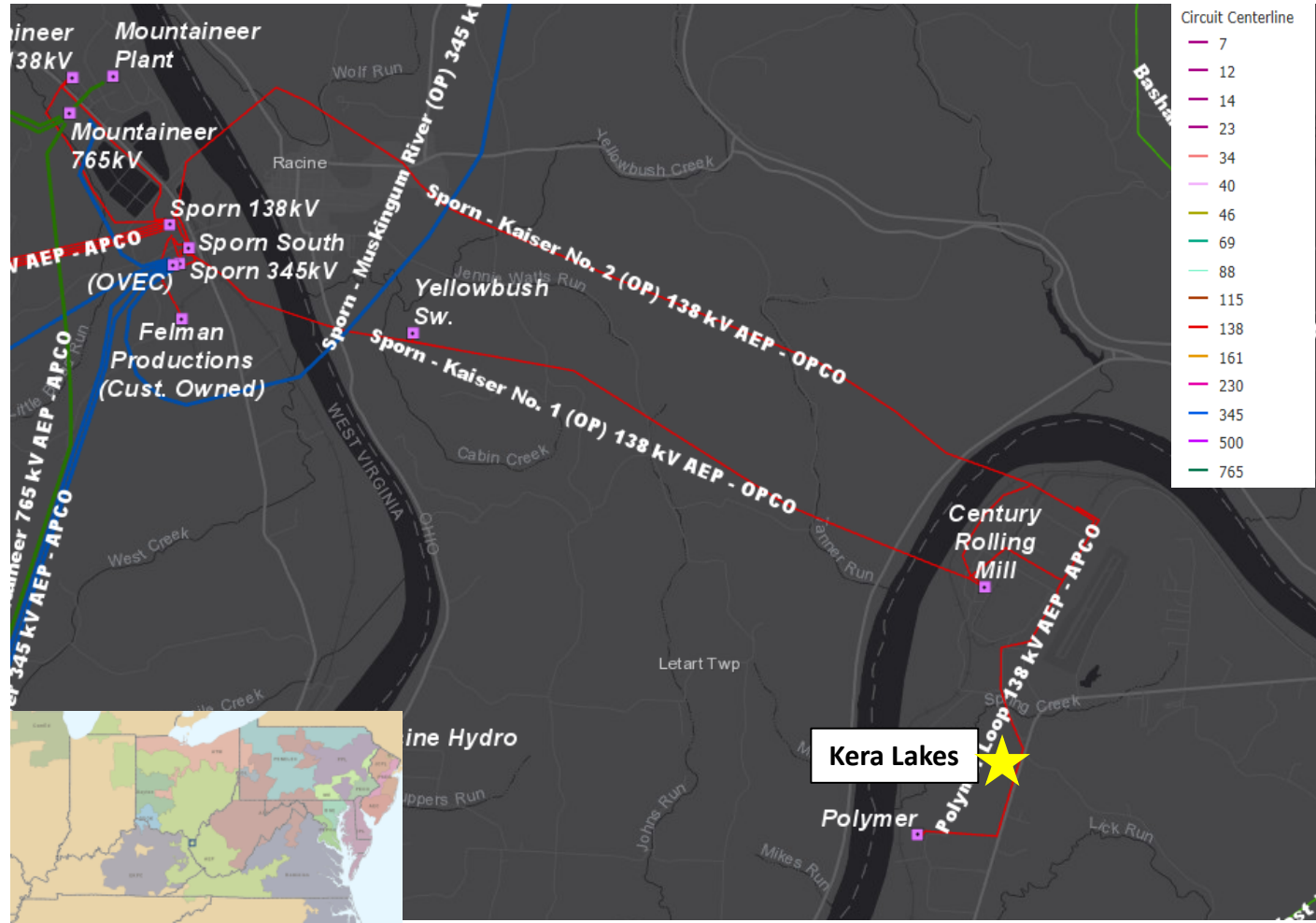

Need Number: AEP-2023-AP021

Process Stage: Submission of Supplemental Project for inclusion in the Local Plan 2/20/2024

Solution:

- Cut in/out of the existing Yellow Bush – Polymer 138 kV line, install a new double circuit 138 kV 0.1 mile line to the new 138 kV station (Kera Lakes). **Estimated Trans. Cost: \$0 (s3137.1)**
- Construct a new 138 kV station (Kera Lakes) with 4 – 3000A, 40 kA circuit breakers in a ring bus configuration with two feeds to the customer. **Estimated Trans. Cost: \$0 (s3137.2)**
- Network fiber support work at Cottageville Station. **Estimated Trans. Cost: \$0 (s3137.3)**

Total Estimated Transmission Cost: \$0

Projected In-Service: 12/13/2024

Supplemental Project ID: s3137.1-.3

Project Status: Scoping

Model: 2028 RTEP

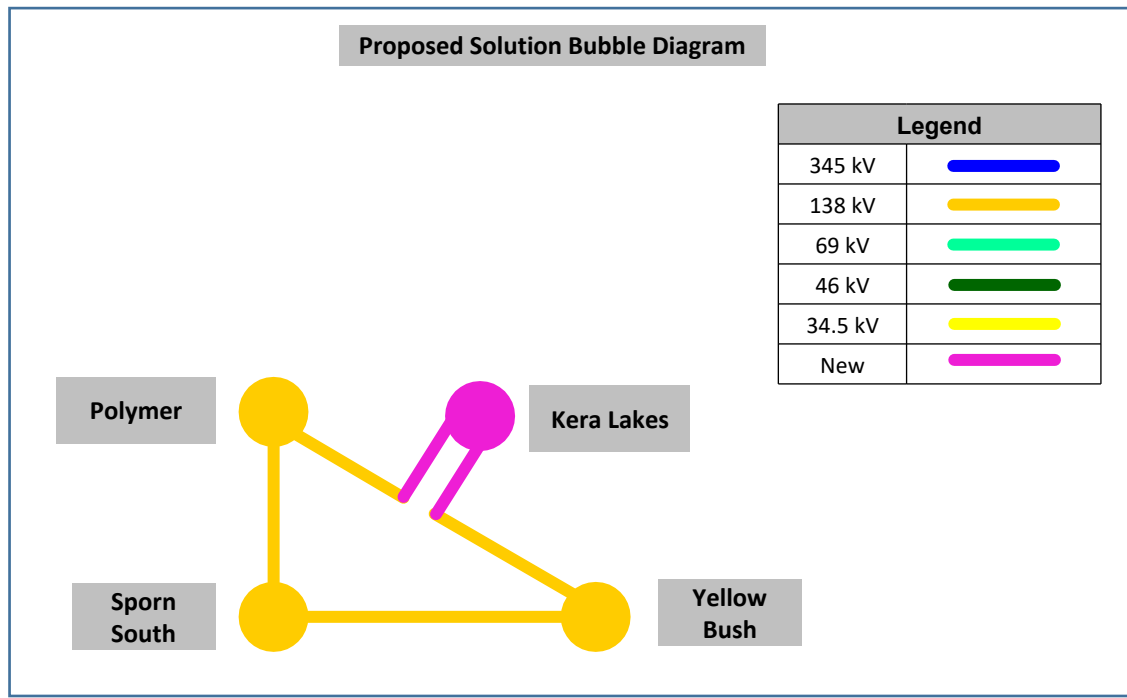
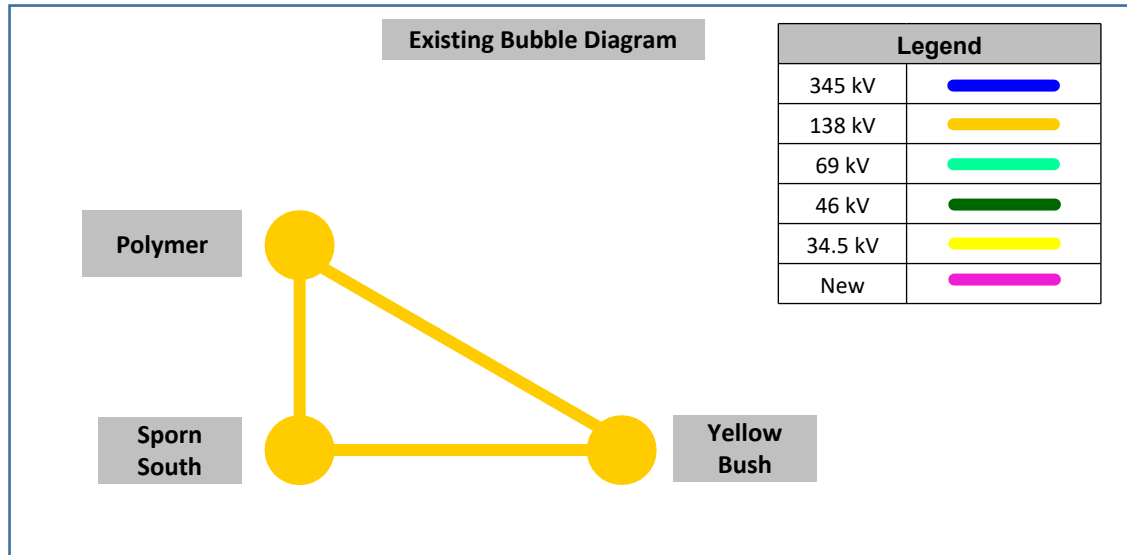

Need Number: AEP-2023-OH012

Process Stage: Submission of Supplemental Project for inclusion in the Local Plan 2/20/2024

Solutions Meeting 11/17/2023

Needs Meeting 1/20/2023

Project Driver:

Customer Service

Service Specific Assumption Reference: AEP Connection Requirements for the AEP Transmission System (AEP Assumptions Slide 12)

Problem Statement:

AEP Ohio has requested to add capacity at Taylor station, due to continuous load growth in the area and to address concerns AEP Ohio has about reliability and contingency constraints. The anticipated peak load is approximately 42 MVA. The requested in-service date is December 2024.

Model: 2027 RTEP

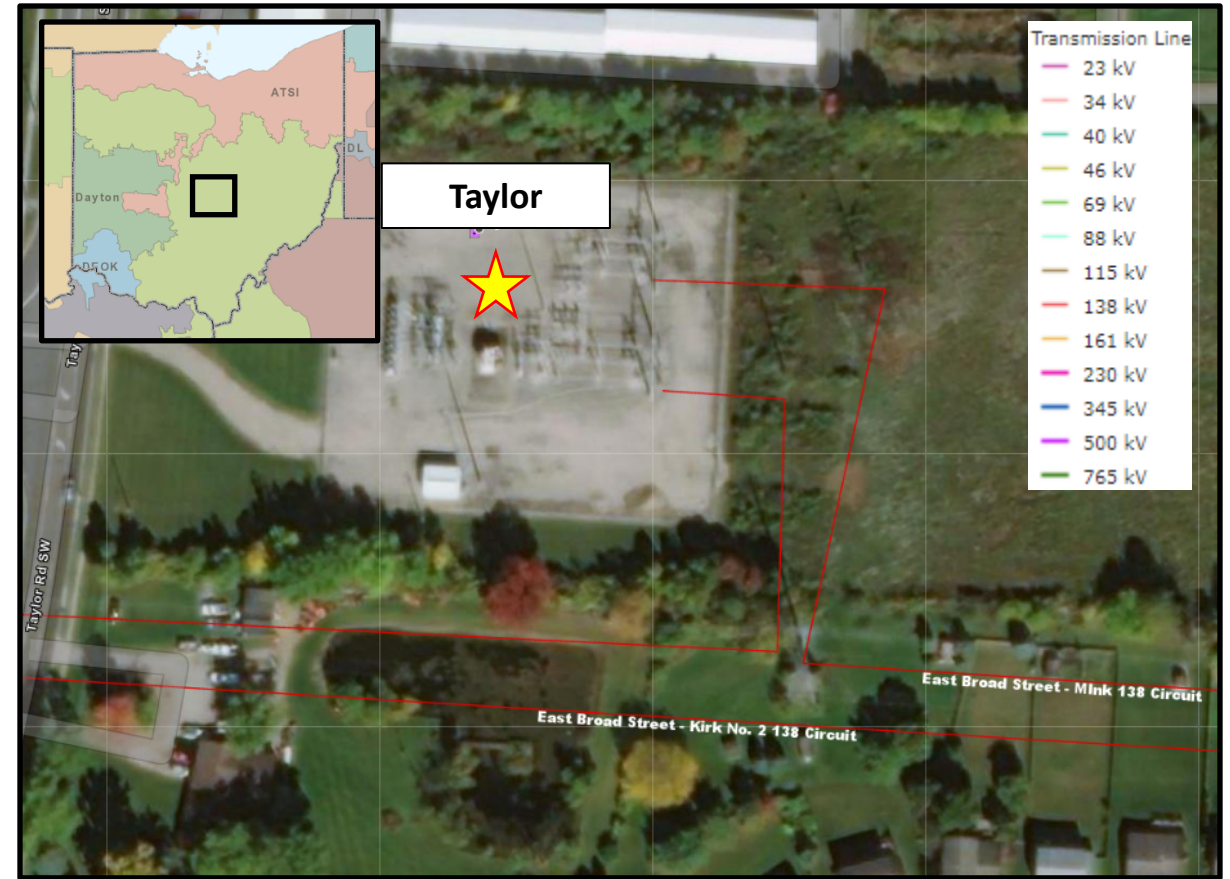

Need Number: AEP-2023-OH012

Process Stage: Submission of Supplemental Project for inclusion in the Local Plan 2/20/2024

Solution:

- At Taylor station, install 1-138 kV 40 kA 3000 A bus tie circuit breaker and 1-138 kV 3000 A 40 kA GOAB beaker disconnect switch to accommodate a new distribution transformer. Estimated Transmission Cost: \$ 1.26M.

Projected In-Service: 12/31/2024

Supplemental Project ID: s3138.1

Project Status: Engineering

Model: 2027 RTEP

Existing:

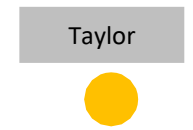

Proposed:

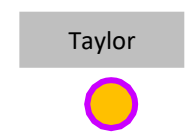

Legend	
765 kV	
345 kV	
138 kV	
69 kV	
34.5 kV	
23 kV	
New	

Need Number: AEP-2022-AP015

Process Stage: Submission of Supplemental Project for inclusion in the Local Plan 2/20/2024

Previously Presented:

Solutions Meeting 11/17/2023

Needs Meeting 2/18/2022

Supplemental Project Driver: Equipment Material/Condition/Performance/Risk

Specific Assumption References: AEP Guidelines for Transmission Owner Identified Needs (AEP Assumptions Slide 13)

Problem Statement:

Pemberton Station

- 46kV circuit breakers B and C are an CG type oil filled breaker, without oil containment.
 - 1984 vintage
 - Oil filled breakers need more maintenance due to the oil handling required
 - These breakers have exceeded the manufacturer’s recommended number of fault operations
 - The manufacturer does not provide support for this type of breaker and spare parts are not available.
 - Oil spills can result in significant mitigation costs.
- 138/46 kV XFR
 - 1984 vintage
 - Multiple oil and nitrogen leaks
 - Bushings are in poor physical condition
 - Cooling controls, cooling fans and internal wiring are obsolete and in need of replacement
 - No secondary oil containment installed on the unit
- 11 of the 25 relays at the station are in need of replacement
 - 4 relays are electromechanical type which have significant limitations with regards to fault data collection and retention.
 - 7 microprocessor relays with legacy firmware

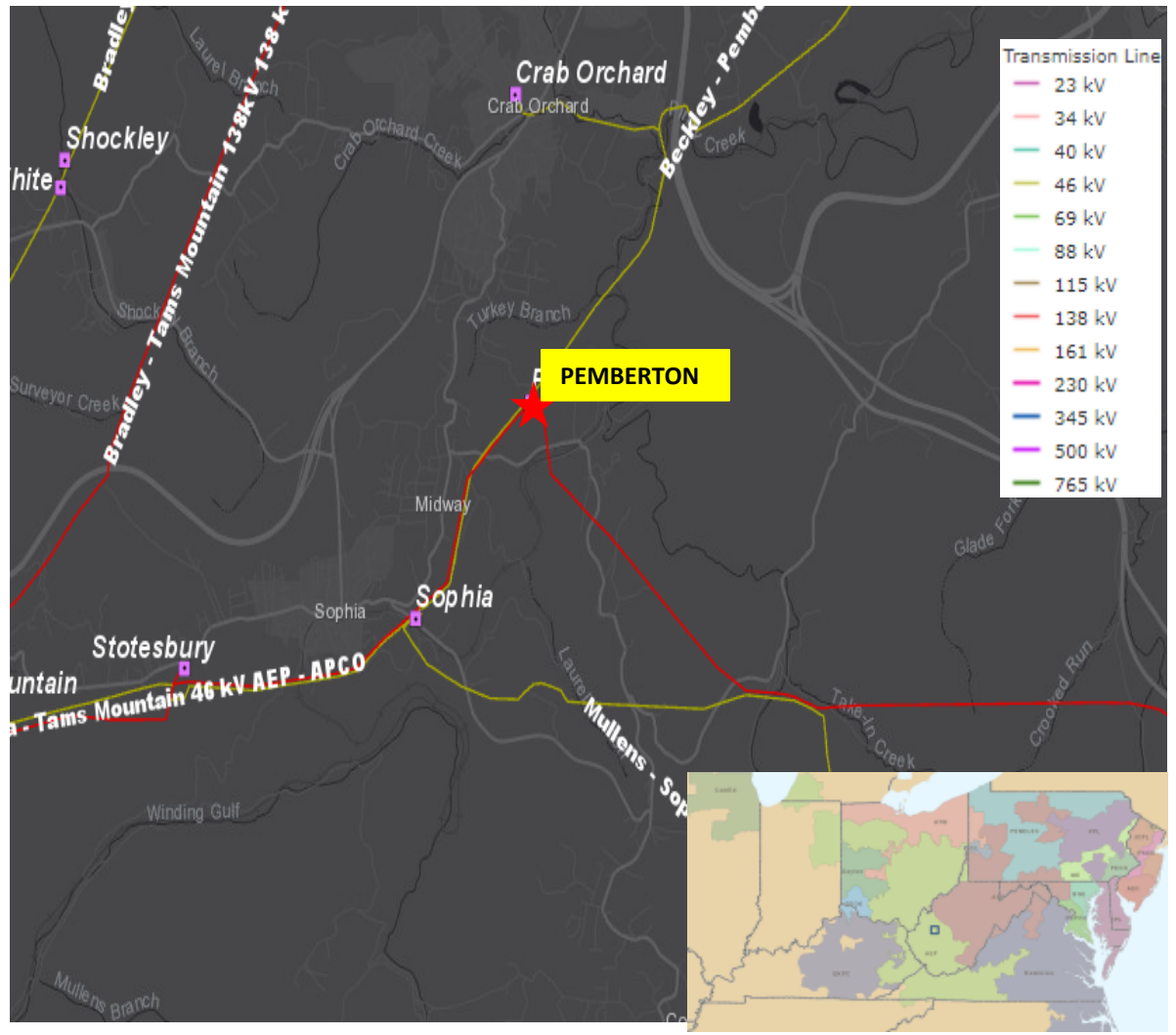

Need Number: AEP-2022-AP016

Process Stage: Submission of Supplemental Project for inclusion in the Local Plan 2/20/2024

Previously Presented:

Solutions Meeting 11/17/2023

Needs Meeting 2/18/2022

Supplemental Project Driver: Equipment Material/Condition/Performance/Risk

Specific Assumption References: AEP Guidelines for Transmission Owner Identified Needs (AEP Assumptions Slide 13)

Problem Statement:

Sophia Station

- 46kV circuit breakers B, C and D are FK type oil filled breaker, without oil containment.
 - 1965 vintage
 - Oil filled breakers need more maintenance due to the oil handling required
 - These breakers have exceeded the manufacturer’s recommended number of fault operations
 - The manufacturer does not provide support for this type of breaker and spare parts are not available.
 - Oil spills can result in significant mitigation costs.
- 23 of the 33 relays at the station are in need of replacement
 - 16 relays are electromechanical type which have significant limitations with regards to fault data collection and retention.
 - 7 microprocessor relays with unsupported firmware.

AEP Transmission Zone: Supplemental Beckley, WV

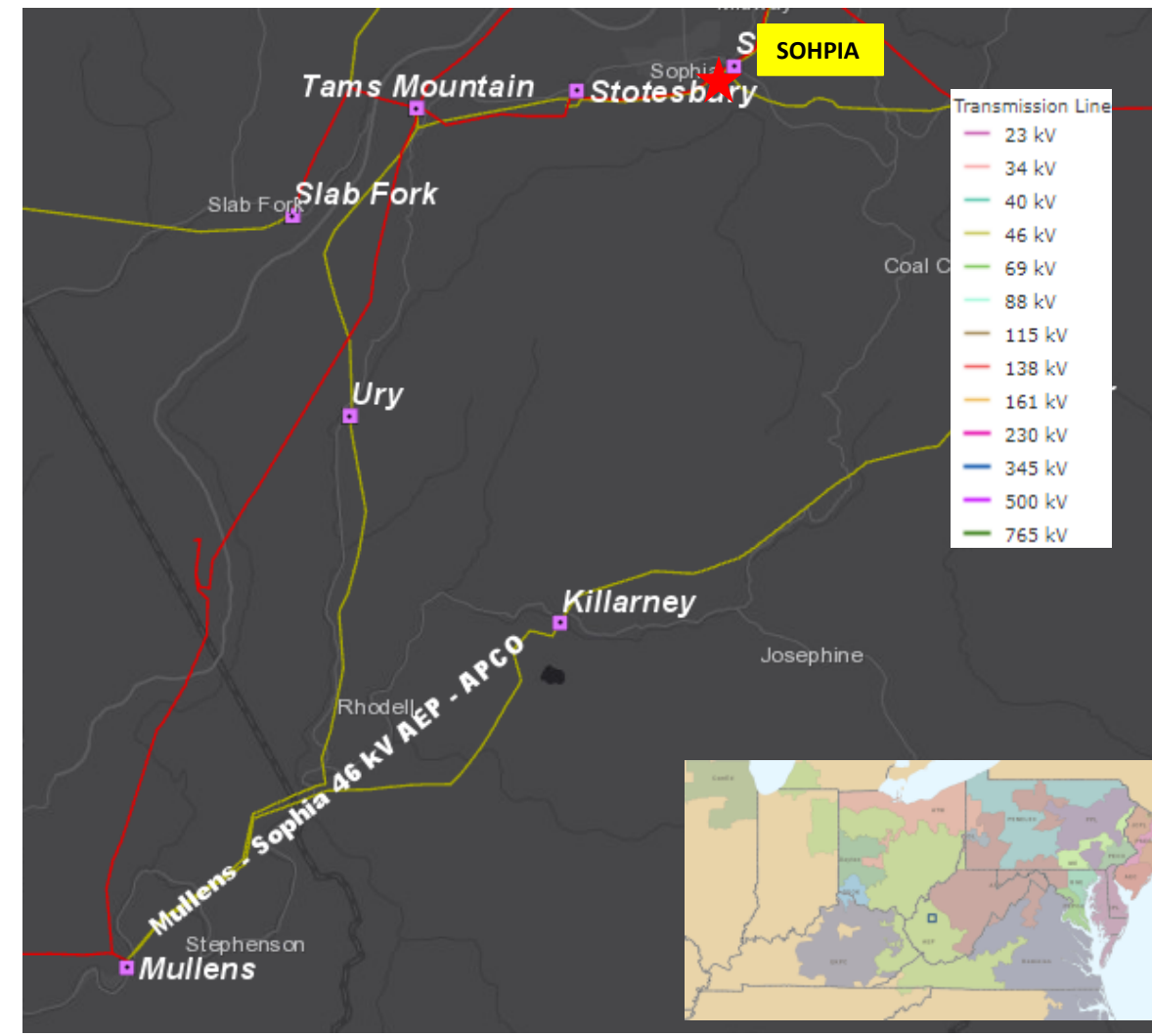

Need Number: AEP-2022-AP017

Process Stage: Submission of Supplemental Project for inclusion in the Local Plan 2/20/2024

Previously Presented:

Solutions Meeting 11/17/2023

Needs Meeting 2/18/2022

Supplemental Project Driver: Equipment Material/Condition/Performance/Risk

Specific Assumption References: AEP Guidelines for Transmission Owner Identified Needs (AEP Assumptions Slide 13), AEP Presentation on 1930s Lines

Problem Statement:

Mullens – Sophia 46 kV (~18 miles)

- Originally constructed in 1914
- Primarily consists of 1914 vintage wood poles (79%) and lattice steel structures (4%)
- Conductor primarily consists of 1951 vintage copper conductor and 1951 vintage 3/0 ACSR conductor
- Since 2015, there have been 19 momentary and 8 permanent outages on the Mullens – Sophia 46 kV circuit.
 - Momentary outages due to lightning, wind, ice/snow, vegetation fall-in outside AEP ROW.
 - Permanent outages due to vegetation fall-in outside AEP ROW, ice/snow, crossarm failure and distribution Outages resulted in 348k CMI
- Currently there are 50 structures (30% of the line) with at least one open structural condition
 - Currently 77 structural open conditions including rotted poles, crossarms, brace, insect damaged poles, crossarms, brace and woodpecker damaged poles.

Condition & Impacts of the Degraded pre-1930s Era System

- These transmission line assets are clearly in the accelerated deterioration phase of their life.
- Significant deterioration results in loss of strength and performance posing a significant risk of failure under conditions the assets should be able to withstand.
 - May cause frequent and extended outages
 - May create significant economic losses
 - May endanger public safety

Conditions of System for the Pre 1930s Lattice Line

- **Towers:** Typical life of galvanizing is 70 years. The towers are all supported by steel grillage foundations buried in the ground. The tower leg is subject to significant risk of corrosion where it enters the ground. Lattice tower structures have little structural redundancy. A failure of one member of the structure will impact the integrity of the structure and may cause the entire tower to collapse.
- **Insulator & Hardware Corrosion:** The connecting elements including the tower attachment hole and the insulator hook have experienced serious section loss due to corrosion and wear. This loss of metal cross-section significantly reduces the capacity of the connection. The insulator caps and connecting hardware have experienced heavy to complete loss of galvanizing. When the protective galvanized coating is gone or is significantly compromised, the bare steel corrodes at an accelerated rate.
- **Broken Insulators:** Broken, cracked and otherwise damaged insulators lead to premature flashover causing permanent outages. When the insulator assembly breaks, the wire falls to the ground potentially damaging other conductors, and presents an increased public safety concern.
- **Conductor:** Aluminum Conductor Steel Reinforced (ACSR) conductor consists of aluminum strands wrapped around a core of galvanized steel strands. The steel provides the structural strength. Like other steel elements, the strands of the core have also lost the galvanized coating and steel section. The degraded state results in significant loss of tensile strength and potential risk to the public if the conductor was to fail and fall to the ground. Conductor damage is usually not visible in a field inspection. Specific conductor samples, from the belly of the sag (lowest point) and/or inside the clamps at the insulators, have confirmed significant corrosion. During the restoration or construction activities, conductors often break at adjacent locations due to handling, introducing a potential safety risk and increase public safety concern.

AEP Transmission Zone: Supplemental Beckley, WV

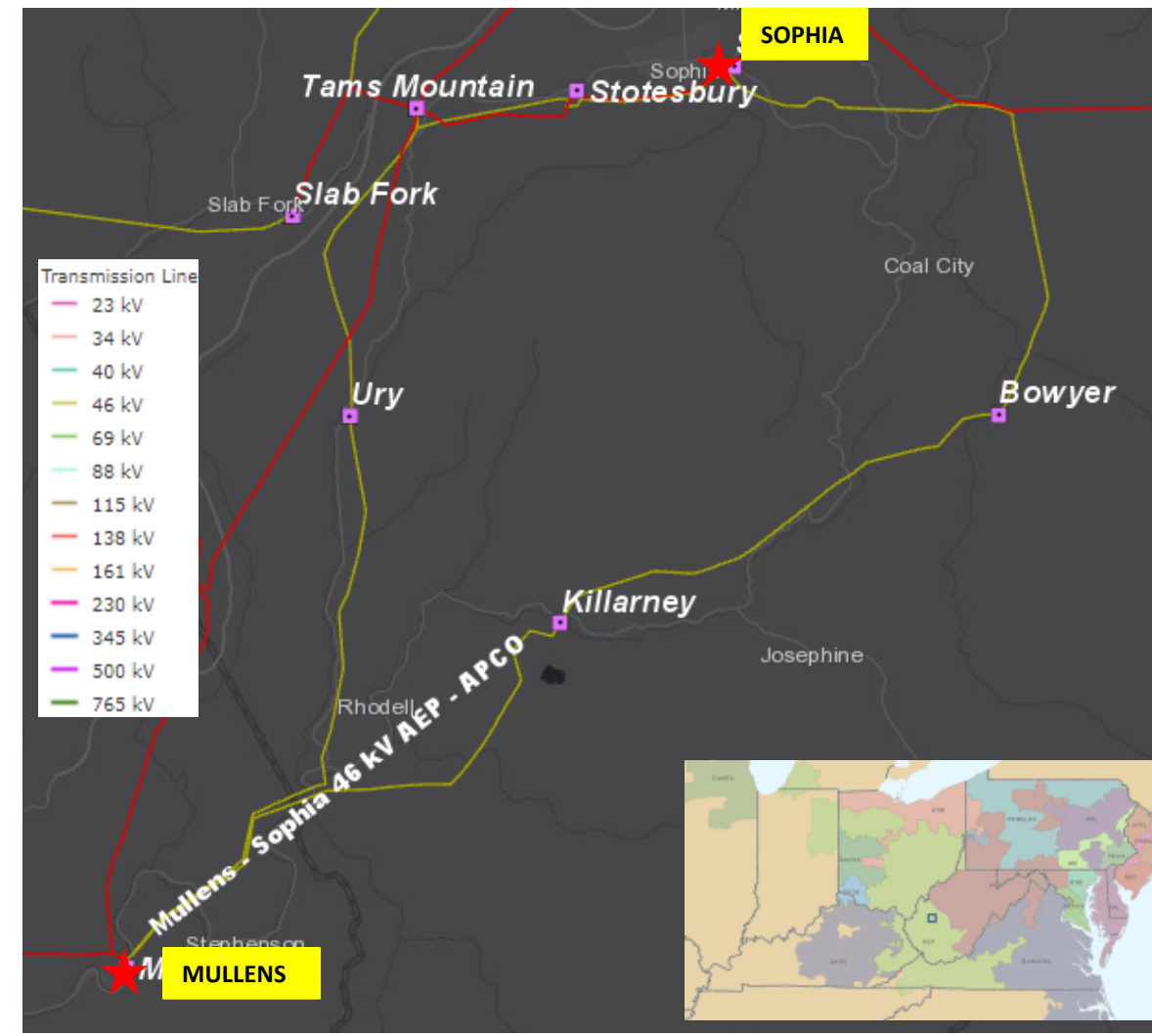

Need Number: AEP-2022-AP018

Process Stage: Submission of Supplemental Project for inclusion in the Local Plan 2/20/2024

Previously Presented:

Solutions Meeting 11/17/2023

Needs Meeting 2/18/2022

Supplemental Project Driver: Equipment Material/Condition/Performance/Risk

Specific Assumption References: AEP Guidelines for Transmission Owner Identified Needs (AEP Assumptions Slide 13)

Problem Statement:

Bradley – Tams Mountain 46 kV (~15 miles)

- Originally constructed in 1920
- Consists primarily of wood pole structures of 1920 (42%), 1950s (13%) and 2002 (20%) vintages
- Conductor consists primarily of 1920 #2 Copper, 336 ACSR, 4/0 ACSR, and 3/0 ACSR
- Since 2015, there have been 13 momentary and 13 permanent outages on the Bradley – Tams Mountain 46 kV circuit.
 - Momentary outages due to lightning, wind, ice/snow, distribution and wind
 - Permanent outages due to vegetation fall-in outside AEP ROW, lightning, ice/snow, non-AEP tree removal, splice failure and vandalism
 - Outages resulted in a total of 980k CMI
- Currently there are 30 structures (19% of the line) with at least one open condition
 - 64 Open conditions affecting poles, crossarms, knee braces, woodpecker holes, insect damage, rot
 - 4 hardware conditions related to broken insulators

AEP Transmission Zone: Supplemental Beckley, WV

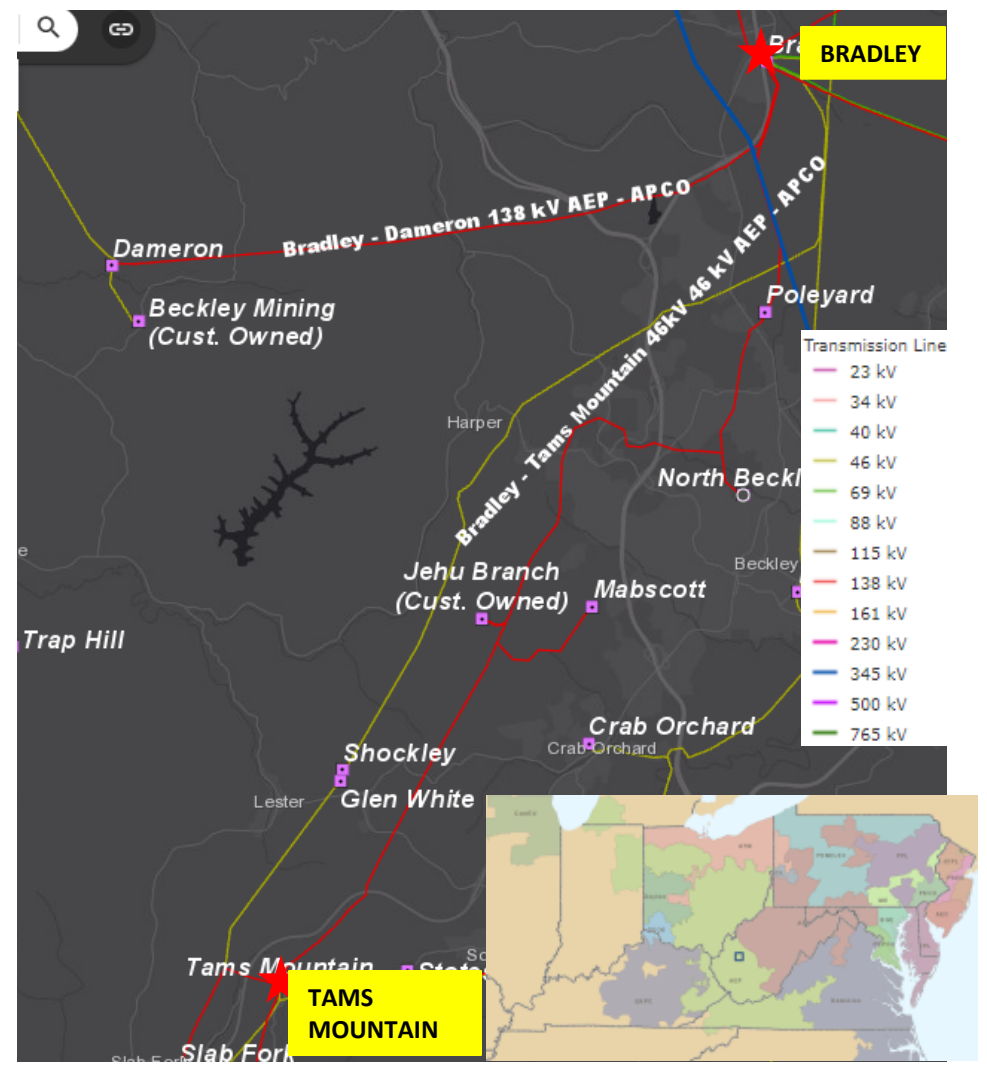

AEP Transmission Zone: Supplemental Beckley, WV

Need Number: AEP-2022-AP019

Process Stage: Submission of Supplemental Project for inclusion in the Local Plan 2/20/2024

Previously Presented: Solutions Meeting 11/17/2023

Needs Meeting 2/18/2022

Supplemental Project Driver: Equipment Material/Condition/Performance/Risk

Specific Assumption References: AEP Guidelines for Transmission Owner Identified Needs (AEP Assumptions Slide 13), AEP Presentation on 1930s Lines

Problem Statement:

Beckley – Pemberton 46 kV (~6 miles)

- Originally constructed in 1913
- Consists of 1913 vintage steel lattice towers (74%) and 1913 wood poles (23%)
- Conductor consists of 1913 vintage 2/0 Copper, 3/0 Copper, 3/0 ACSR and 556 ACSR

Condition & Impacts of the Degraded pre-1930s Era System

- These transmission line assets are clearly in the accelerated deterioration phase of their life.
- Significant deterioration results in loss of strength and performance posing a significant risk of failure under conditions the assets should be able to withstand.
 - May cause frequent and extended outages
 - May create significant economic losses
 - May endanger public safety

Conditions of System for the Pre 1930s Lattice Line

- Towers: Typical life of galvanizing is 70 years. The towers are all supported by steel grillage foundations buried in the ground. The tower leg is subject to significant risk of corrosion where it enters the ground. Lattice tower structures have little structural redundancy. A failure of one member of the structure will impact the integrity of the structure and may cause the entire tower to collapse.
- Insulator & Hardware Corrosion: The connecting elements including the tower attachment hole and the insulator hook have experienced serious section loss due to corrosion and wear. This loss of metal cross-section significantly reduces the capacity of the connection. The insulator caps and connecting hardware have experienced heavy to complete loss of galvanizing. When the protective galvanized coating is gone or is significantly compromised, the bare steel corrodes at an accelerated rate.
- Broken Insulators: Broken, cracked and otherwise damaged insulators lead to premature flashover causing permanent outages. When the insulator assembly breaks, the wire falls to the ground potentially damaging other conductors, and presents an increased public safety concern.
- Conductor: Aluminum Conductor Steel Reinforced (ACSR) conductor consists of aluminum strands wrapped around a core of galvanized steel strands. The steel provides the structural strength. Like other steel elements, the strands of the core have also lost the galvanized coating and steel section. The degraded state results in significant loss of tensile strength and potential risk to the public if the conductor was to fail and fall to the ground. Conductor damage is usually not visible in a field inspection. Specific conductor samples, from the belly of the sag (lowest point) and/or inside the clamps at the insulators, have confirmed significant corrosion. During the restoration or construction activities, conductors often break at adjacent locations due to handling, introducing a potential safety risk and increase public safety concern.

Crab Orchard 46 kV Tap (~1 mile)

- Originally constructed in 1946
- Consists primarily of wood pole structures of 1946 vintage (94%)
- Conductor consists of 1946 3/0 ACSR

Since 2014, there have been 6 momentary and 3 permanent outages on the Beckley – Pemberton 46 kV circuit (includes Crab Orchard Tap).

- Momentary outages due to lightning, wind, ice/snow, distribution,
- Permanent outage due to vegetation fall-in outside AEP ROW and lightning.
- Outages resulted in a total of 248k CMI

Currently there are 7 structures (10% of the line) with at least one open condition
 2 conditions related to rust on lacing and leg, 1 condition affecting broken strand on conductor, 5 conditions related broken insulators and 2 forestry related conditions

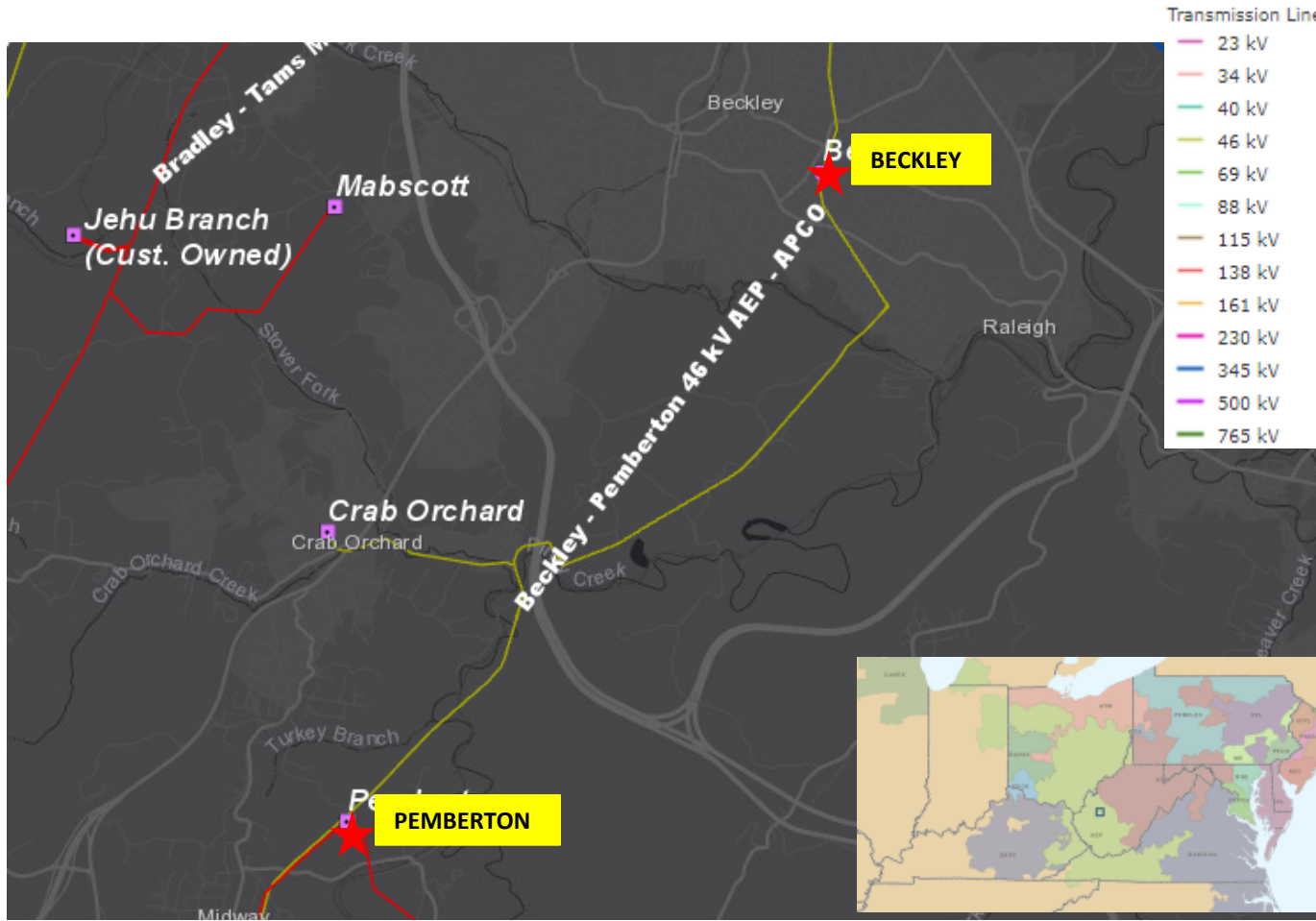

Need Number: AEP-2022-AP020

Process Stage: Submission of Supplemental Project for inclusion in the Local Plan 2/20/2024

Previously Presented:

Solutions Meeting 11/17/2023

Needs Meeting 2/18/2022

Supplemental Project Driver: Equipment Material/Condition/Performance/Risk

Specific Assumption References: AEP Guidelines for Transmission Owner Identified Needs (AEP Assumptions Slide 13), AEP Presentation on 1930s Lines

Problem Statement:

Sophia – Tams Mountain 46 kV (~4 miles)

- Originally constructed in 1915
- Consists of 1915 vintage wood (65%) and steel lattice structures (33%)
- Conductor consists of 1915 vintage copper conductor and 556 ACSR
- Since 2014, there have been 2 momentary and 1 permanent outages on the Sophia – Tams Mountain 46 kV circuit.
 - Momentary outages due to ice/snow
 - Permanent outage due to lightning
- Currently there are 6 structures (15% of the line) with at least one open structural condition
 - 6 structural open conditions affecting pole, knee/vee brace and crossarms including corroded, broke, split and rot top

Condition & Impacts of the Degraded pre-1930s Era System

- These transmission line assets are clearly in the accelerated deterioration phase of their life.
- Significant deterioration results in loss of strength and performance posing a significant risk of failure under conditions the assets should be able to withstand.
 - May cause frequent and extended outages
 - May create significant economic losses
 - May endanger public safety

Conditions of System for the Pre 1930s Lattice Line

- **Towers:** Typical life of galvanizing is 70 years. The towers are all supported by steel grillage foundations buried in the ground. The tower leg is subject to significant risk of corrosion where it enters the ground. Lattice tower structures have little structural redundancy. A failure of one member of the structure will impact the integrity of the structure and may cause the entire tower to collapse.
- **Insulator & Hardware Corrosion:** The connecting elements including the tower attachment hole and the insulator hook have experienced serious section loss due to corrosion and wear. This loss of metal cross-section significantly reduces the capacity of the connection. The insulator caps and connecting hardware have experienced heavy to complete loss of galvanizing. When the protective galvanized coating is gone or is significantly compromised, the bare steel corrodes at an accelerated rate.
- **Broken Insulators:** Broken, cracked and otherwise damaged insulators lead to premature flashover causing permanent outages. When the insulator assembly breaks, the wire falls to the ground potentially damaging other conductors, and presents an increased public safety concern.
- **Conductor:** Aluminum Conductor Steel Reinforced (ACSR) conductor consists of aluminum strands wrapped around a core of galvanized steel strands. The steel provides the structural strength. Like other steel elements, the strands of the core have also lost the galvanized coating and steel section. The degraded state results in significant loss of tensile strength and potential risk to the public if the conductor was to fail and fall to the ground. Conductor damage is usually not visible in a field inspection. Specific conductor samples, from the belly of the sag (lowest point) and/or inside the clamps at the insulators, have confirmed significant corrosion. During the restoration or construction activities, conductors often break at adjacent locations due to handling, introducing a potential safety risk and increase public safety concern.

AEP Transmission Zone: Supplemental Beckley, WV

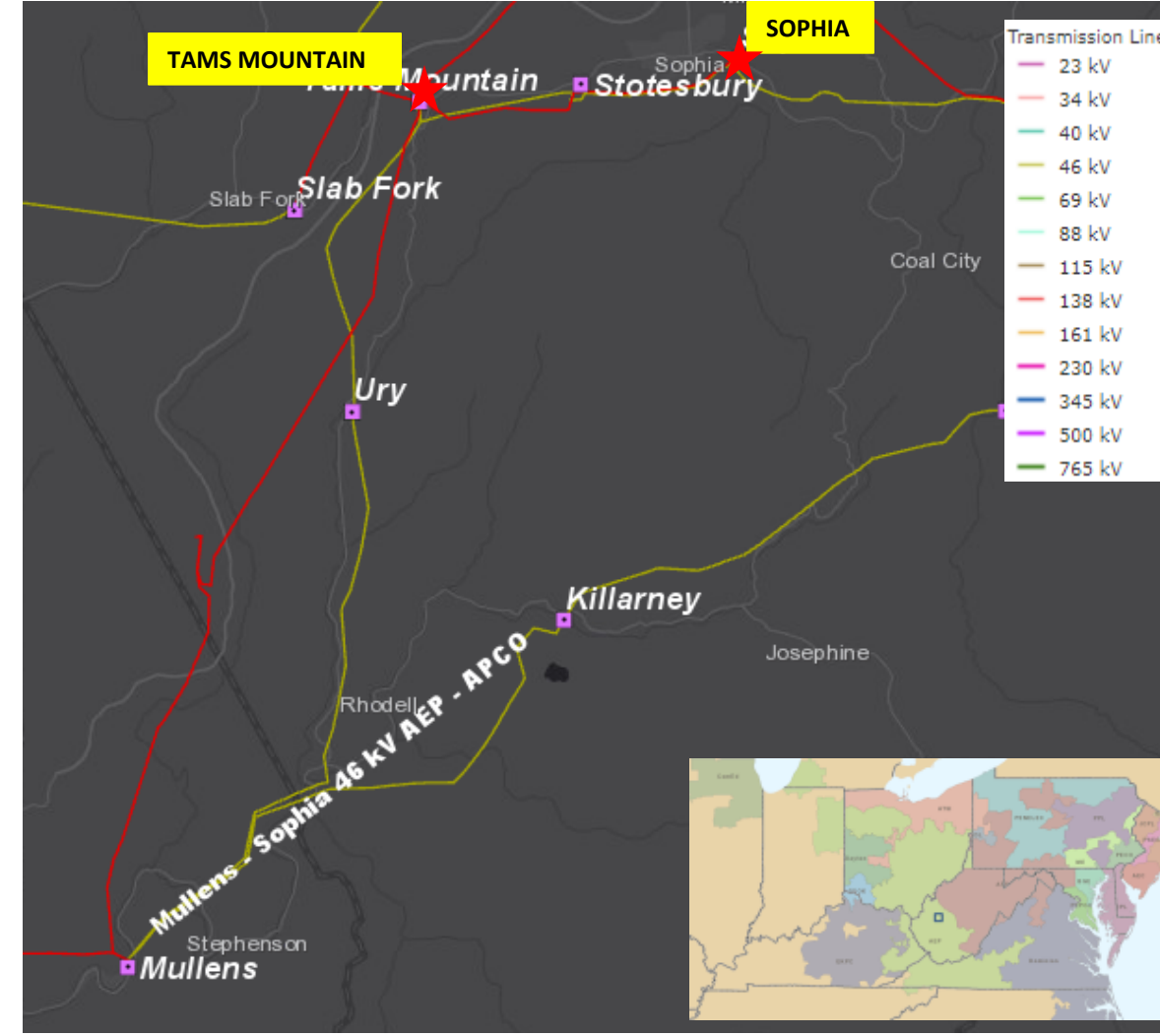

Need Number: AEP-2022-AP021

Process Stage: Submission of Supplemental Project for inclusion in the Local Plan 2/20/2024

Previously Presented:

Solutions Meeting 11/17/2023

Needs Meeting 2/18/2022

Supplemental Project Driver: Equipment Material/Condition/Performance/Risk

Specific Assumption References: AEP Guidelines for Transmission Owner Identified Needs (AEP Assumptions Slide 13), AEP Presentation on 1930s Lines

Problem Statement:

Beckley – Bradley 46 kV (~7 miles)

- Originally constructed in 1913
- Consists of 1913 vintage steel lattice towers and wood poles (40%) and 2002 wood poles (56%)
- Conductor consists of 1913 vintage 3/0 Copper (92%) and some 2005 vintage 556 ACSR
- Since 2015, there have been 43 momentary and 1 permanent outages on the Beckley – Bradley 46 kV circuit.
 - Momentary outages due to lightning, wind, ice/snow, distribution, relay misoperation, vegetation fall-in outside AEP ROW.
 - Permanent outage due to Distribution
 - Peak Load Impact: 21.68 MVA

Condition & Impacts of the Degraded pre-1930s Era System

- These transmission line assets are clearly in the accelerated deterioration phase of their life.
- Significant deterioration results in loss of strength and performance posing a significant risk of failure under conditions the assets should be able to withstand.
 - May cause frequent and extended outages
 - May create significant economic losses
 - May endanger public safety

Conditions of System for the Pre 1930s Lattice Line

- Towers:** Typical life of galvanizing is 70 years. The towers are all supported by steel grillage foundations buried in the ground. The tower leg is subject to significant risk of corrosion where it enters the ground. Lattice tower structures have little structural redundancy. A failure of one member of the structure will impact the integrity of the structure and may cause the entire tower to collapse.
- Insulator & Hardware Corrosion:** The connecting elements including the tower attachment hole and the insulator hook have experienced serious section loss due to corrosion and wear. This loss of metal cross-section significantly reduces the capacity of the connection. The insulator caps and connecting hardware have experienced heavy to complete loss of galvanizing. When the protective galvanized coating is gone or is significantly compromised, the bare steel corrodes at an accelerated rate.
- Broken Insulators:** Broken, cracked and otherwise damaged insulators lead to premature flashover causing permanent outages. When the insulator assembly breaks, the wire falls to the ground potentially damaging other conductors, and presents an increased public safety concern.
- Conductor:** Aluminum Conductor Steel Reinforced (ACSR) conductor consists of aluminum strands wrapped around a core of galvanized steel strands. The steel provides the structural strength. Like other steel elements, the strands of the core have also lost the galvanized coating and steel section. The degraded state results in significant loss of tensile strength and potential risk to the public if the conductor was to fail and fall to the ground. Conductor damage is usually not visible in a field inspection. Specific conductor samples, from the belly of the sag (lowest point) and/or inside the clamps at the insulators, have confirmed significant corrosion. During the restoration or construction activities, conductors often break at adjacent locations due to handling, introducing a potential safety risk and increase public safety concern.

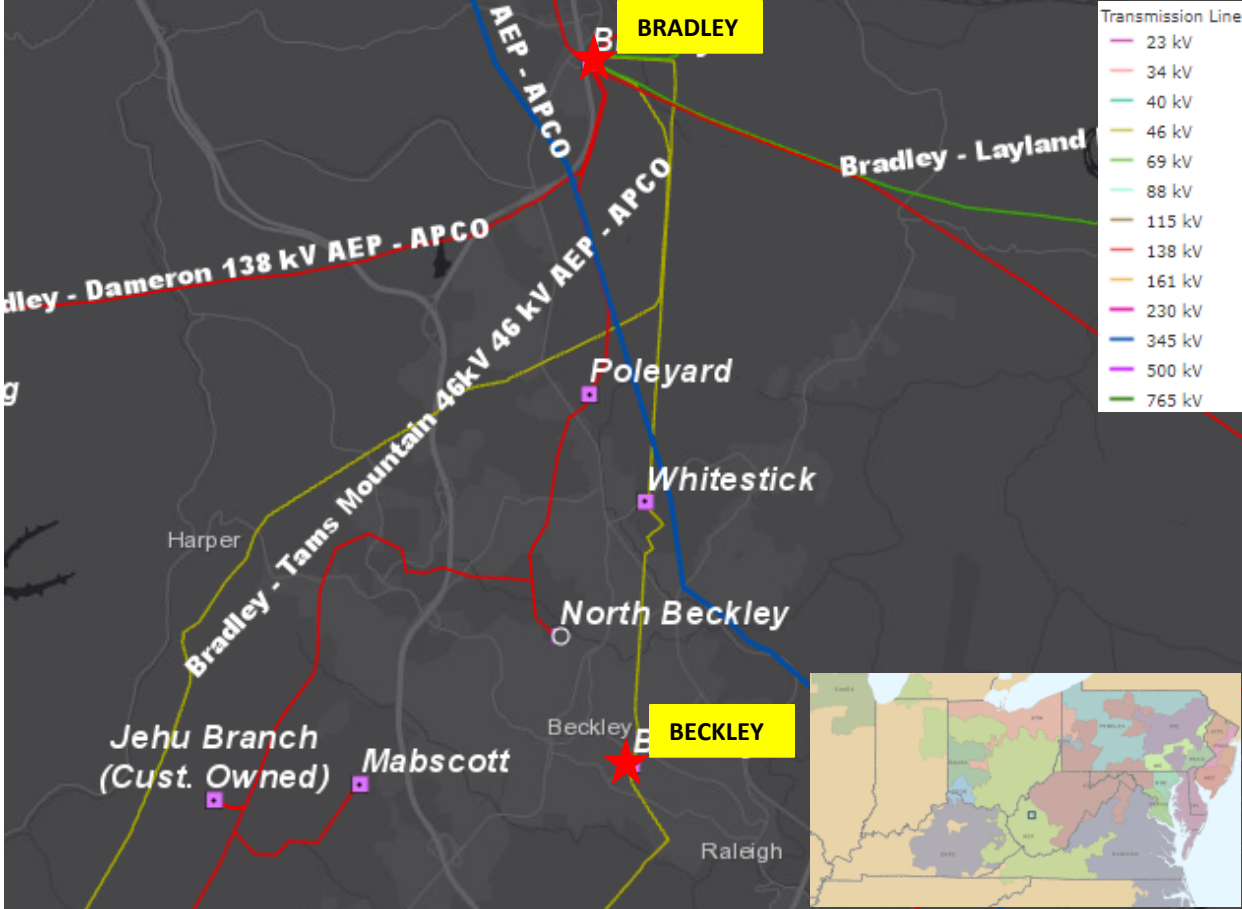

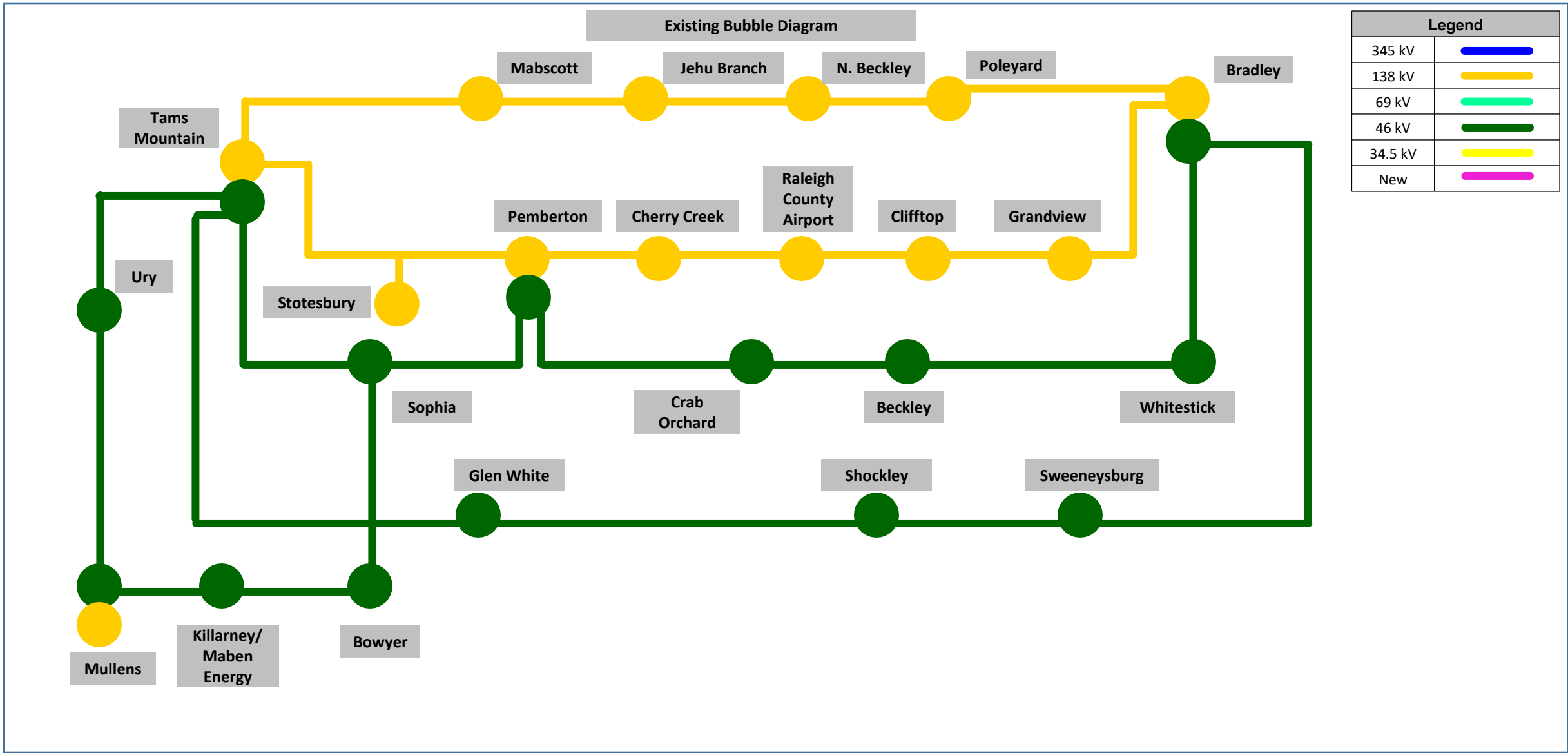

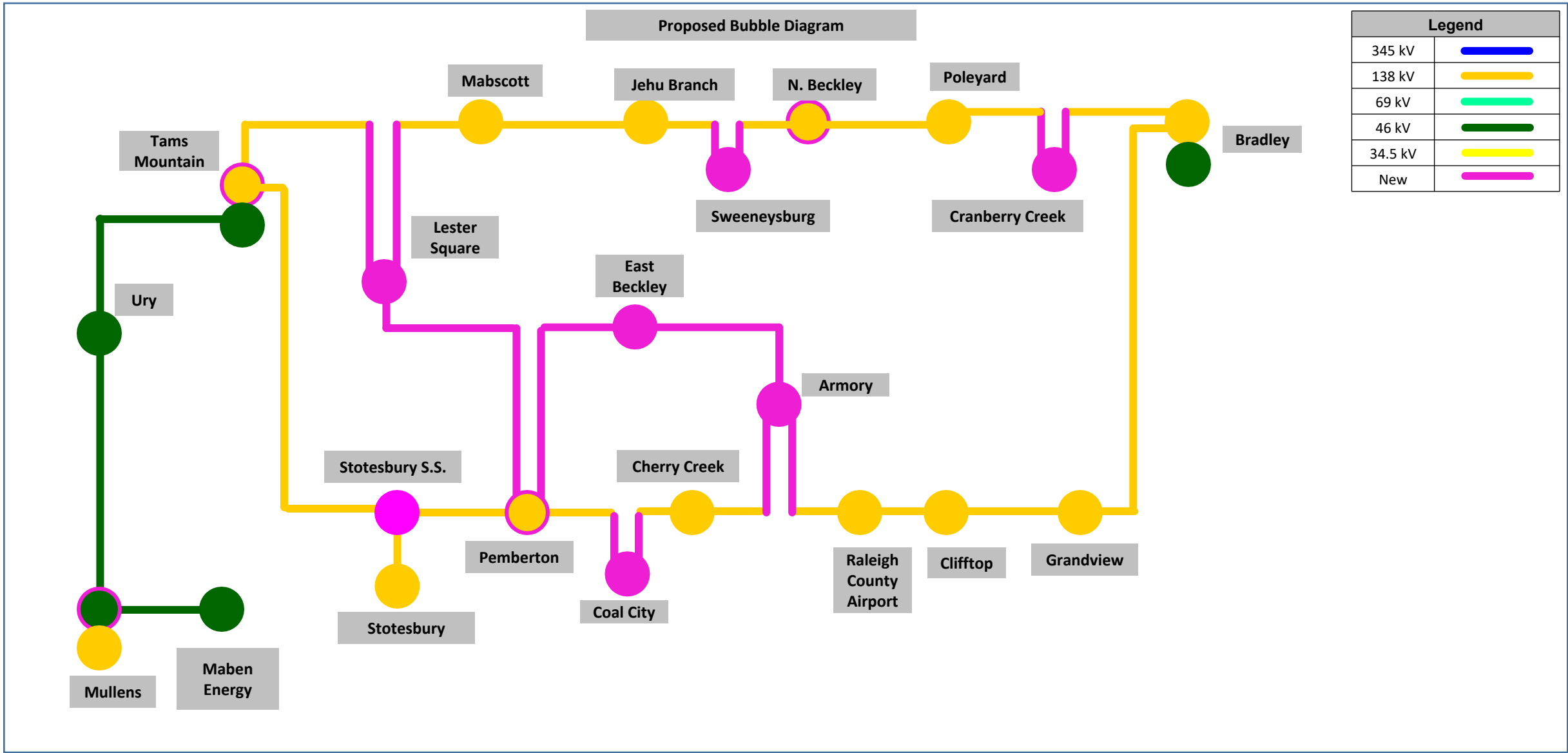

Need Number: AEP-2022-AP015, AEP-2022-AP016, AEP-2022-AP017, AEP-2022-AP018, AEP-2022-AP019, AEP-2022-AP020, AEP-2022-AP021

Process Stage: Submission of Supplemental Project for inclusion in the Local Plan 2/20/2024

Solution

- Construct a new double circuit 138 kV line (approx. 1 miles) by tapping the existing Cherry Creek – Pemberton 138 kV and building in/out to a new 138 kV station near Coal City. **Estimated Trans. Cost: \$5.4M (s3139.1)**
 - Retire existing 46 kV line from Sophia – Maben Energy. **Estimated Trans. Cost: \$11.5M (s3139.2)**
 - Retire existing Sophia – Tams Mountain 46 kV line **Estimated Trans. Cost: \$4.7M (s3139.3)**
 - Retire existing Pemberton – Sophia 46 kV line. **Estimated Trans. Cost: \$3.3M (s3139.4)**
- New Coal City Station: Install two 138 kV line MOABs, one 138/12 kV 20 MVA XFR with high side circuit switcher and two 12 kV feeders **Estimated Trans. Cost: \$1.0M (s3139.5)**
- Retire Sophia 46 kV Station **Estimated Trans. Cost: \$1.4M (s3139.6)**
- Pemberton Station: Install a new 138/46 kV XFR with a high side circuit switcher and new metering. This will feed the customer currently served out of Sophia Station. Construct a new 1 mile 46 kV line from Pemberton to the customer. Install two new 138 kV circuit breakers . Retire 138/46 kV XFR, 46 kV CB-A, 46 kV CB-C and 4 kV distribution equipment. Install one new 138 kV circuit breaker. Retire 46 kV CB-B **Estimated Trans. Cost: \$10.7M (s3139.7)**
- Stotesbury: Replace existing hard tap with a new 3-way phase over phase switch **Estimated Trans. Cost: \$1.8M (s3139.8)**
- Retire Killarney 46 kV Station **Estimated Trans. Cost: \$0.0M (s3139.9)**
- Retire Bowyer 46 kV Station **Estimated Trans. Cost: \$0.0M (s3139.10)**
- Tams Mountain: Remove 46 kV CB-N2 and 46 kV CB M **Estimated Trans. Cost: \$1.1M (s3139.11)**

Proposed Solution Bubble Diagram

Legend	
345 kV	
138 kV	
69 kV	
46 kV	
34.5 kV	
New	

SEE PREVIOUS SLIDES

Need Number: AEP-2022-AP015, AEP-2022-AP016, AEP-2022-AP017, AEP-2022-AP018, AEP-2022-AP019, AEP-2022-AP020, AEP-2022-AP021

Process Stage: Submission of Supplemental Project for inclusion in the Local Plan 2/20/2024

Solution

- Construct a new double circuit 138 kV line in/out (approx. 1 mile) to the existing Sweeneysburg Switch Station **Estimated Trans. Cost: \$3.8M (s3139.12)**
- Construct a new 138 kV double circuit line (approx. 2 miles) by tapping the existing North Beckley – Tams Mountain 138 kV line and building in/out to a new 138 kV station (Lester Square Station) **Estimated Trans. Cost: \$9.9M (s3139.13)**
- Construct a new 138 kV single circuit line (approx. 1.2 miles) from the new Lester Square Station to the existing Pemberton 138 kV station. **Estimated Trans. Cost: \$6.6M (s3139.14)**
- Retire Glen White Station **Estimated Trans. Cost: \$0.0M (s3139.15)**
- Retire Shockley Station **Estimated Trans. Cost: \$0.1M (s3139.16)**
- Retire Bradley – Tams Mountain 46 kV line: **Estimated Trans. Cost: \$20.3M (s3139.17)**
- Sweeneysburg Switch: Convert to 138 kV **Estimated Trans. Cost: \$0.1M (s3139.18)**
- Lester Square: Install five 138 kV CBs in a ring configuration, install one 23 MVAR capacitor bank with a circuit switcher, install a new 138/12 kV 20 MVA XFR with two 12 kV feeders. Install a new 138/46 kV XFR to feed the customer previously served from Shockley Station. Construct a new 46 kV line from Lester Square to the customer previously served at Shockley Station. **Estimated Trans. Cost: \$5.9M (s3139.19)**
- North Beckley Station: Remote End work required due to the new line cut in to Lester Square Station. **Estimated Trans. Cost: \$0.6M (s3139.20)**
- Bradley Station: Remove 46 kV CB-F, Retire 46 kV CB-J **Estimated Trans. Cost: \$0.8M (s3139.21)**
- Construct a new 138 kV double circuit line (approx. 1.5 miles) tapping the existing Bradley – North Beckley 138 kV line and building in/out to a new 138 kV station (Cranberry Creek) **Estimated Trans. Cost: \$7.9M (s3139.22)**

Proposed Solution Bubble Diagram

Legend	
345 kV	
138 kV	
69 kV	
46 kV	
34.5 kV	
New	

SEE PREVIOUS SLIDES

Need Number: AEP-2022-AP015, AEP-2022-AP016, AEP-2022-AP017, AEP-2022-AP018, AEP-2022-AP019, AEP-2022-AP020, AEP-2022-AP021

Process Stage: Submission of Supplemental Project for inclusion in the Local Plan 2/20/2024

Ancillary Benefits: Alternate consists of 51 total miles of line needing to be rebuilt. The proposed solution consists of a total of 14.5 miles of greenfield line. Additionally, as part of the proposed solution the following deteriorating Distribution station equipment will be retired: Beckley Station 3 – 12 kV CBs, 2 – 46/12 kV XFRs, 25 EM relays, 1 RTU. Whitestick Station 3 – 12 kV CBs, 1 – 46/12 kV XFR, 18 EM relays. Crab Orchard Station 1 – 46/12 kV XFR, 1 RTU. Pemberton Station 1 – 46/4 kV XFR. Killarney Station 1 – 46/7.2 kV XFR. Bowyer Station 1 – 46/12 kV XFR. Glen White Station 1 – 46/12 kV XFR, 4 EM Relays

Projected In-Service: 6/10/2031

Supplemental Project ID: s3139.1-.35

Project Status: Scoping

Model: 2028 RTEP

AEP Transmission Zone M-3 Process Buchanan County, Virginia

Need Number: AEP-2022-AP040

Process Stage: Submission of Supplemental Project for inclusion in the Local Plan 3/20/2024

Previously Presented:

Solution Meeting 01/19/2024

Need Meeting 11/18/2022

Supplemental Project Driver: Equipment Condition/Performance/Risk

Specific Assumption Reference:

AEP Guidelines for Transmission Owner Identified Needs (AEP Assumptions Slide 13)

Problem Statement:

Line Name: Big Rock - Grundy 34.5kV Circuit

Original Install Date (Age): 1932

Length of Line: ~6.4 mi

Total structure count: 70

Original Line Construction Type: Wood

Conductor Type: 1/0 Copper, 1/0 AAAC, 4/0 ACSR, 336,000 ACSR, 556,000 ACSR

Momentary/Permanent Outages: 2 Permanent causing 856k CMI since 2017

Line Conditions:

- The line structures fail to meet 2017 NESC Grade B loading criteria, current AEP structural strength requirements, and the current ASCE structural strength requirements.
- 67 of the 70 structures are 1930s vintage accounting for 96% of the structures.
- The line is insulated in some segments with Distribution class cap and pin insulators which do not meet current AEP standards for CIFO and minimum leakage distance requirements. Shield wire is not present on significant segments of this line.
- The line is radial and serves a peak nontransferable load of 2.63 MVA at Thomas and 1.8 MVA at Big Rock substations.

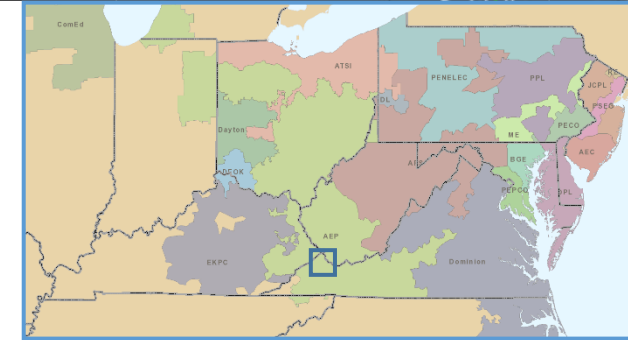
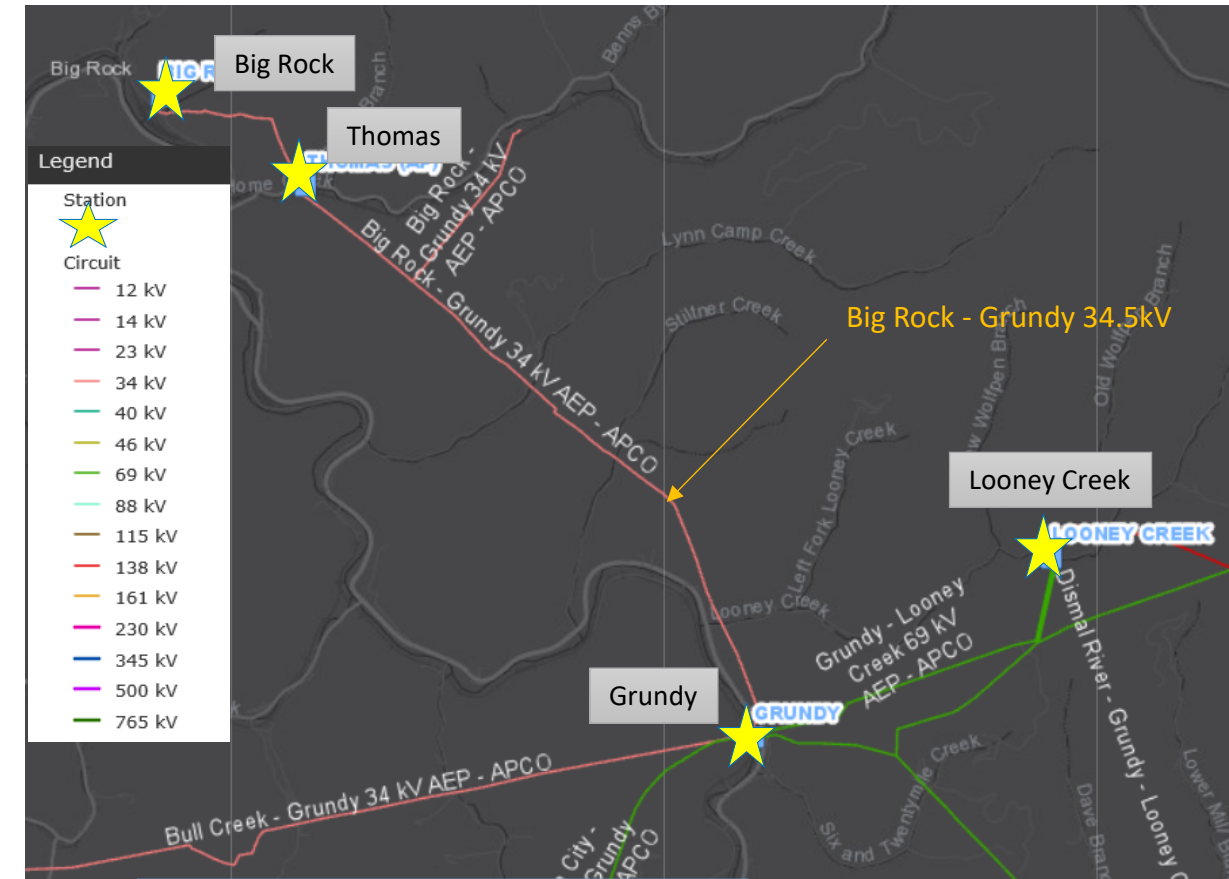



AEP Transmission Zone M-3 Process Buchanan County, Virginia

Need Number: AEP-2022-AP040

Process Stage: Submission of Supplemental Project for inclusion in the Local Plan 3/20/2024

Solution:

- Construct a new 69 kV line from the existing Looney Creek station to the greenfield Conaway station, approximately 6.1 miles long. New right of way is needed from Looney Creek to Conaway station. The line cost is driven by very steep terrain and the miles of access roads required and access road restoration cost, which is a requirement in Virginia. Estimated Cost: \$30.2M **(s3211.1)**
- Construct a greenfield station (Conaway) to replace Big Rock and Thomas stations. Conaway will contain a 69/12 kV 20 MVA transformer with high side circuit switcher. There will be two 12 kV feeders from the station. The 69 kV side will be a straight bus with 69 kV MOABs. Distribution work is required to reconnect the Distribution system to the new Conaway station. Estimated Cost: \$0.0 (Distribution cost) **(s3211.2)**
- At the existing Looney Creek station, a new 69 kV circuit breaker will be installed to connect the Conaway – Looney Creek 69 kV line. Replace the high side 138kV MOAB ground switch with a 138 kV circuit breaker due to protection and control at the station. Estimated Cost: \$2.44M **(s3211.3)**
- Remove the ~6.4 mile long Big Rock – Grundy 34.5 kV line. Estimated cost: \$5.08M **(s3211.4)**
- Remove 34.5 kV circuit breaker “D” and 34.5 KV circuit breaker “C” at Grundy station. Estimated cost: \$0.4M **(s3211.5)**
- Remove the Big Rock station and equipment. Estimated cost: \$0.0 (Distribution cost) **(s3211.6)**
- Remove the Thomas station and equipment. Estimated cost: \$0.0 (Distribution cost) **(s3211.7)**

Total Estimated Transmission Cost: \$38.12 M

Ancillary Benefits: Consolidation of two Distribution stations into one. The current Big Rock station is next to a coal mine that is expanding their land refugee towards Big Rock station which would require significant work in the future if Big Rock was not being retired.

Projected In-Service: 5/1/2028

Supplemental Project ID: s3211.1-.7

Project Status: Scoping

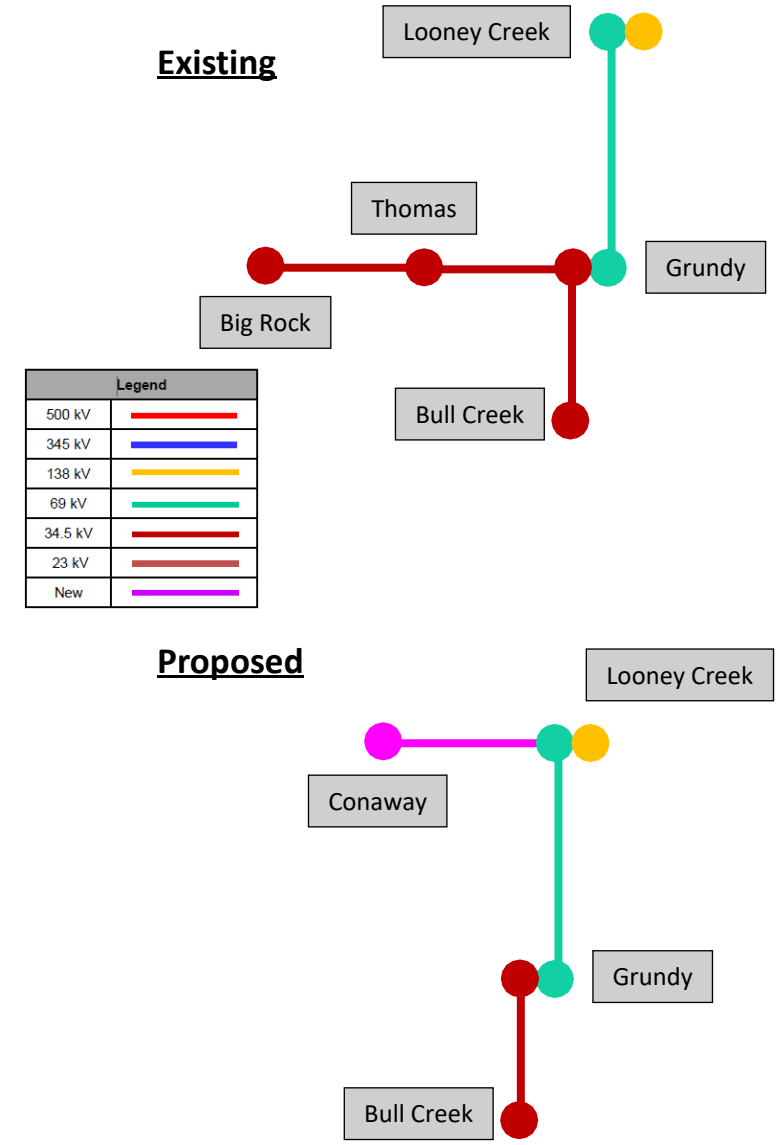

Need Number: AEP-2023-OH043

Process Stage: Submission of Supplemental Project for inclusion in the Local Plan 3/20/2024

Previously Presented:

Solutions Meeting 1/19/2024

Need Meeting 03/17/2023

Project Driver:

Customer Service

Specific Assumption Reference:

AEP Connection Requirements for the AEP Transmission System (AEP Assumptions Slide 12)

Problem Statement:

- AEP Ohio has requested a 69kV delivery near Northern Van Wert.
- The anticipated load is 15MVA
- AEP Ohio has requested an in-service date of 12/31/2024

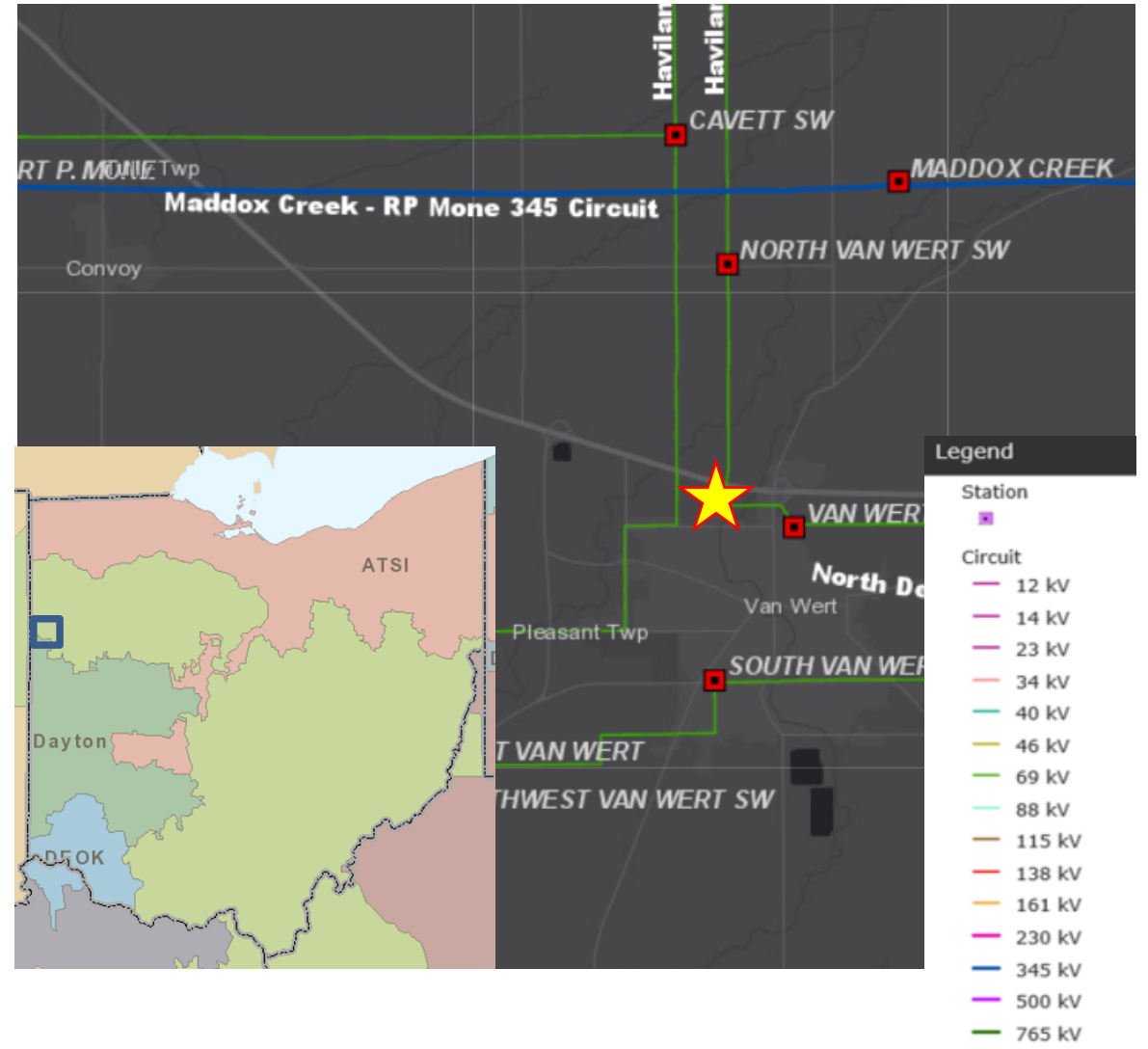



AEP Transmission Zone M-3 Process Van Wert, Ohio

Need Number: AEP-2023-OH043

Process Stage: Submission of Supplemental Project for inclusion in the Local Plan 3/20/2024

Solution:

Vision Station: A new 69/12 kV distribution station (Vision) will be constructed. The station will be an in and out design utilizing in line MOAB's. Estimated Cost: 1.12M **(s3212.1)**

West Van Wert – Cavett 69 kV: Work will be performed on the West Van Wert – Cavett 69 kV circuit to cut in the newly proposed Vision station . Estimated Cost: 2.99M **(s3212.2)**

Total Estimated Transmission Cost: 4.11M

Projected In-Service: 12/01/2024

Supplemental Project ID: s3212.1-.2

Project Status: Engineering

Model: 2028 RTEP

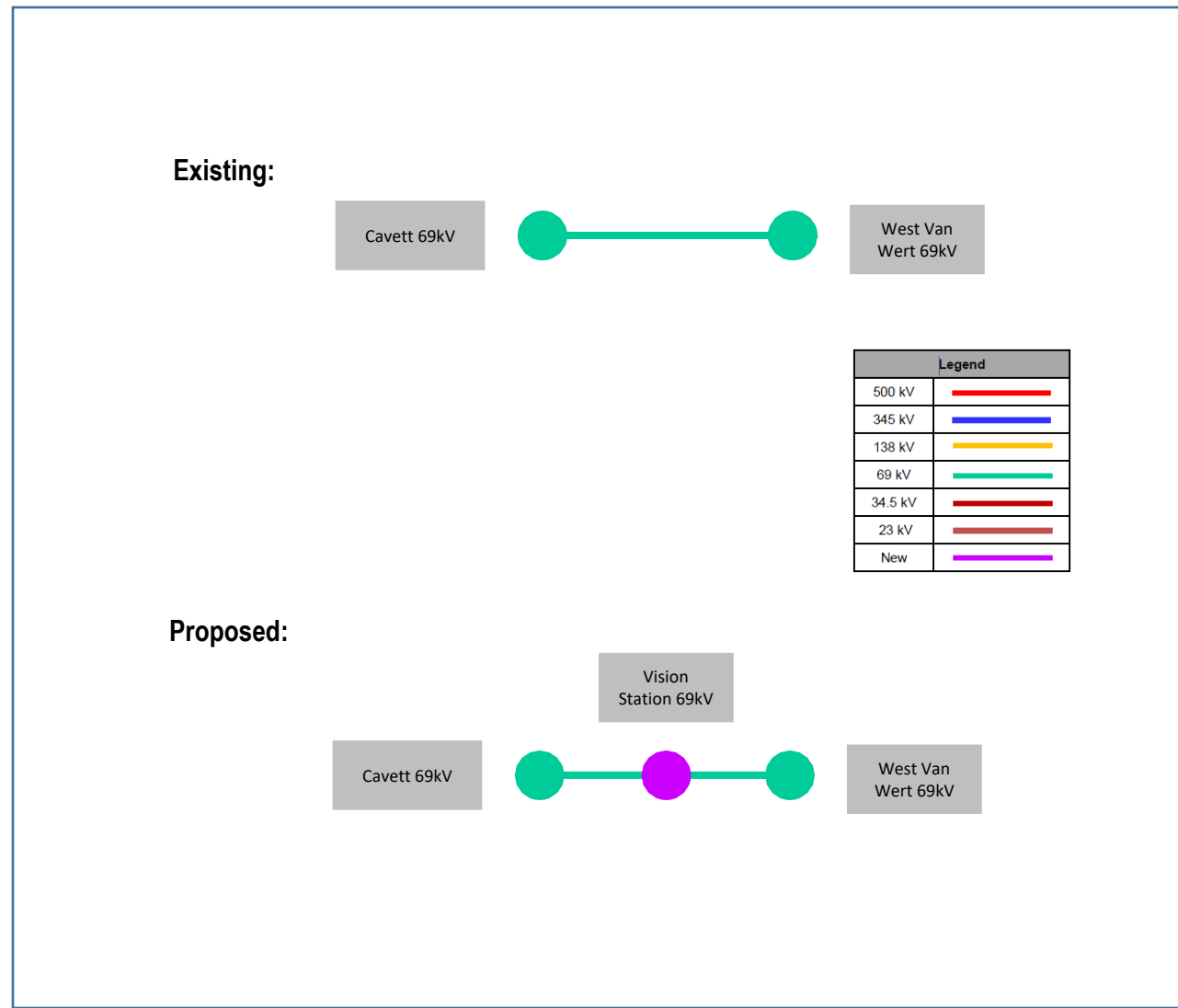

Need Number: AEP-2023-OH047

Process Stage: Submission of Supplemental Project for inclusion in the Local Plan 3/20/2024

Previously Presented:

- Solution Meeting 1/19/2024
- Needs Meeting 3/17/2023

Project Driver: Customer Service

Specific Assumption Reference:

AEP Guidelines for Transmission Owner Identified Needs (AEP Assumptions Slide 13)

Problem Statement:

Customer Service:

- Four customers have requested distribution service at a site South of AEP’s existing Trabue station in Columbus, OH.
- The customers have indicated a total peak demand of 33.5 MVA of new capacity and 5.5 MVA of alternate capacity at the site.
- The customer has a requested an in-service date of 2/29/2024.

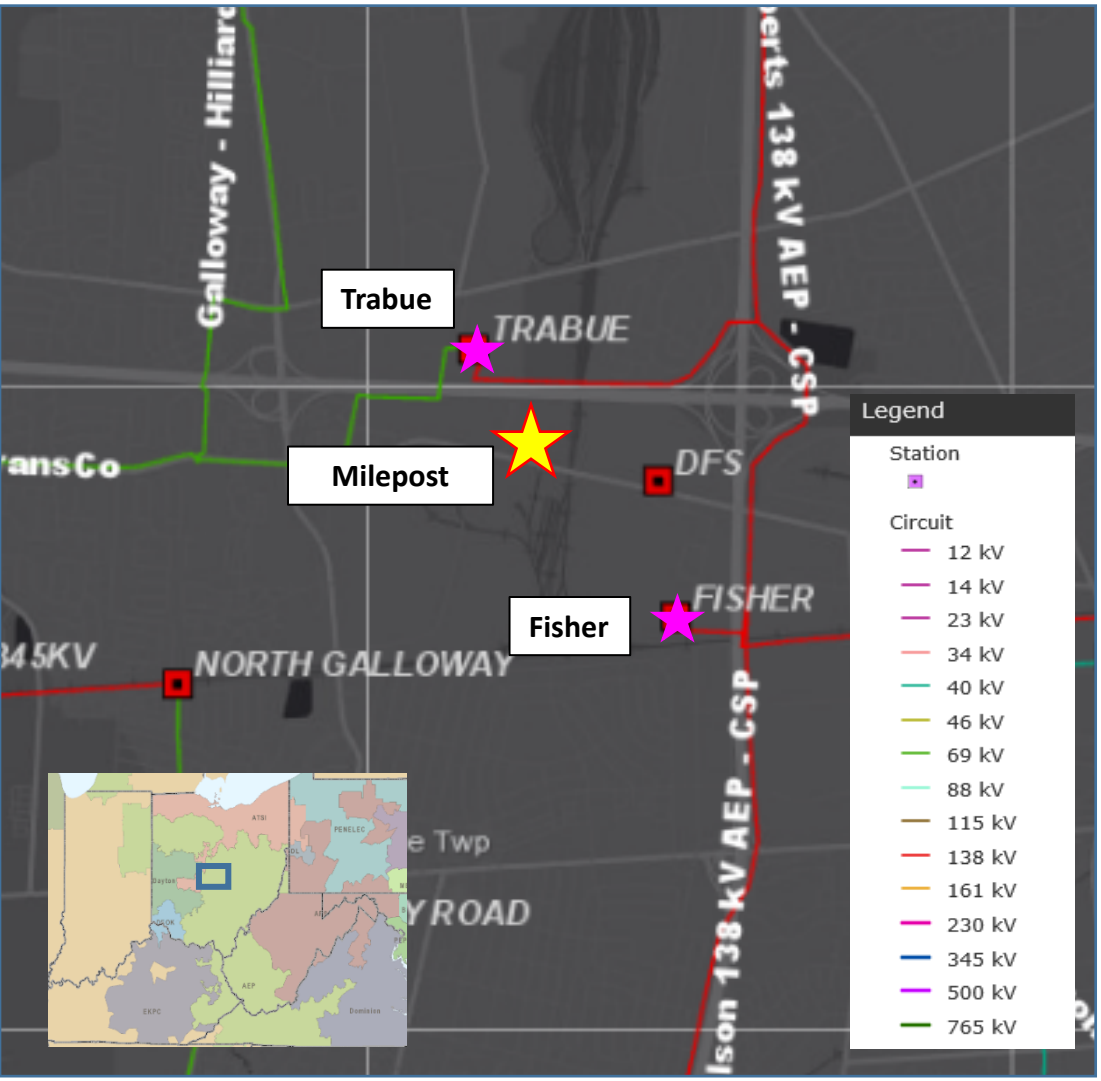

Need Number: AEP-2023-OH047

Process Stage: Submission of Supplemental Project for inclusion in the Local Plan 3/20/2024

Solution:

- Construct a greenfield station “Milepost”, utilizing three 138kV 63kA 3000A circuit breakers configured in a ring to serve new customer loads. Estimated Cost: \$4.54 M **(s3213.1)**
- Cut into the Roberts - Trabue 138 kV circuit and construct a new 0.14-mile double circuit 138kV in and out line to the new Milepost station utilizing 795 ACSR conductor SE: 360 MVA. Estimated Cost: \$2.79 M **(s3213.2)**
- Remote end work to accommodate the above work at Cole, Roberts, & Trabue. Estimated Cost: \$0.17 M **(s3213.3)**

To accommodate the 33.5 MVA customer at Milepost the following work will be completed to resolve overloads on the 138/69 kV transformer at Bethel and station equipment at Blaine due to the new bulk load addition:

- Retire 3.3 miles of the Bethel Rd – Hilliard 69 kV line from Bethel Rd to the structure adjacent to Davidson 69 kV. Build a 0.3-mile extension connecting the line from Hilliard to Davidson using 795 ACSR conductor creating the Hilliard – Davidson 69 kV circuit. Estimated Cost: \$2.92 M **(s3213.4)**
- Retire Bethel Road 138/69/13.8 kV Transformer #3 and associated breakers. Install a new 138/69 kV transformer at Davidson station with a high side MOAB and a single 69kV 3000A 40kA breaker on the low side connecting to the reconfigured Davidson - Hilliard 69 kV circuit. Estimated Cost: \$1.58 M **(s3213.5)**
- Upgrade Sub Cond 477 AAC 19 Str. at Blaire 69 kV. Estimated Cost: \$.05 M **(s3213.6)**

Total Estimated Cost: \$12.05 M

Ancillary Benefits:

- The proposed project will address needs on a 1963 vintage transformer and two oil breakers manufactured in 1967 at Bethel Road station identified as part of AEP need # AEP-2023-OH053.
- In addition, the project will allow for the retirement of ~3.3 miles of a 1960s vintage wood pole line located in a densely populated suburb of Dublin, OH with a river crossing.

Projected In-Service: 04/15/2024

Supplemental Project ID: s3213.1-.6





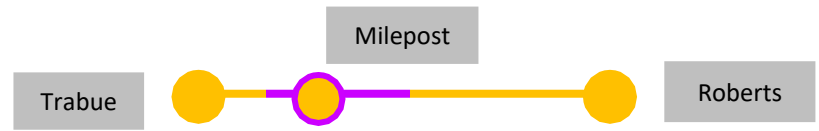

Project Status: Engineering

Existing:



Proposed:



Legend	
765 kV	
345 kV	
138 kV	
69 kV	
34.5 kV	
23 kV	
New	



BOUNDLESS ENERGY™

AEP Transmission Zone M-3 Process Jackson County, Ohio

Need Number: AEP-2023-OH057

Process Stage: Submission of Supplemental Project for inclusion in the Local Plan 3/20/2024

Previously Presented:

Solutions Meeting 1/19/2024

Need Meeting 07/21/2023

Project Driver: Customer Service

Specific Assumption Reference: AEP Guidelines for Transmission Owner Identified Needs (AEP Assumptions Slide 12)

Problem Statement:

The City of Jackson has requested a new transmission feed for their Veterans station separate from their existing 138 kV feed from AEP's Lick station. The city of Jackson currently serves approximately 25 MW of load via Lick station.

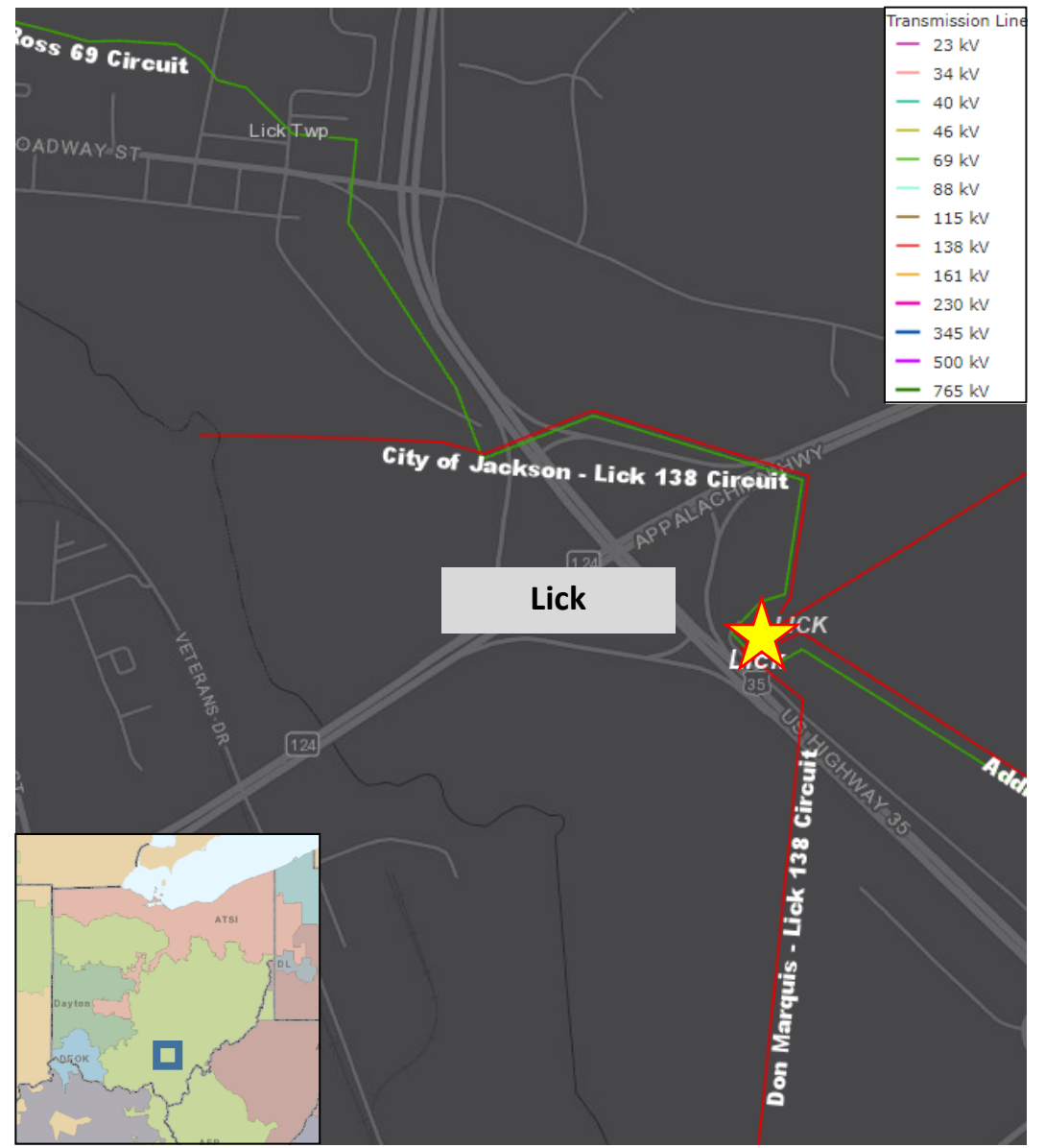

AEP Transmission Zone M-3 Process Jackson County, Ohio

Need Number: AEP-2023-OH057

Process Stage: Submission of Supplemental Project for inclusion in the Local Plan 3/20/2024

Solution:

- Pattonsville Switch: Install new 138kV phase-over-phase switch on the Corwin-Lick 138kV circuit. Install metering towards Veterans. **Estimated Cost: \$0.67 M (s3214.1)**
- Pattonsville Switch Extension: Install ~0.3 miles of line from Pattonsville Switch to Veterans. **Estimated Cost: \$0.45 M (s3214.2)**
- Poston-Lick 138 kV: Modify existing line to accommodate switch installation. **Estimated cost: \$0.32 M (s3214.3)**
- Heppner-Lick 138 kV: Remove span of line from City of Jackson’s Lick station toward Veterans. **Estimated cost: \$0.1M (s3214.4)**

Estimated Total Transmission Cost: \$1.53 M

Projected In-Service: 12/31/2024

Supplemental Project ID: s3214.1-.4

Project Status: Scoping

Existing:



Proposed:

Legend	
765 kV	
345 kV	
138 kV	
69 kV	
34.5 kV	
23 kV	
New	

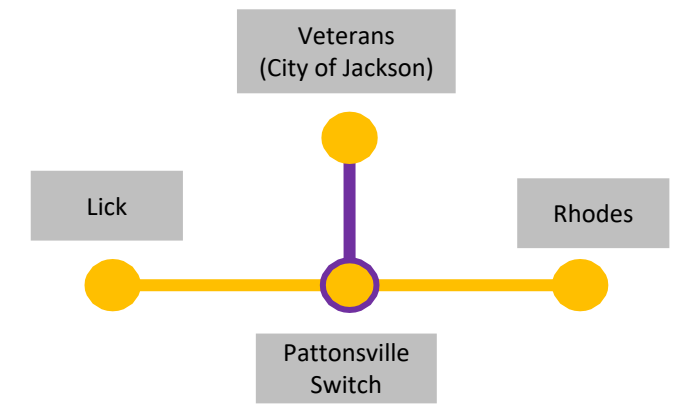

Need Number: AEP-2022-AP022

Process Stage: Submission of Supplemental Project for inclusion in the Local Plan 3/20/2024

Previously Presented:

Solution Meeting 1/19/2024

Need Meeting 4/22/2022

Supplemental Project Driver: Equipment Condition/Performance/Risk

Specific Assumption Reference:

AEP Guidelines for Transmission Owner Identified Needs (AEP Assumptions Slide 13)

Problem Statement Carswell Station:

- The 138/88-8kV transmission transformers Phase A, B, C and Spare are of 1949 vintage. The insulating paper material has become brittle and this puts the unit's ability to withstand future short circuit or through fault events at greater risk. There have been multiple malfunction reports regarding active oil leaks on bank Phase C. The presence of Ethane, along with the indication of overheating faults, indicates that decomposition of the non-thermally upgraded and increasingly brittle paper insulation is impairing the units' ability to withstand future short circuit or through fault events.
- The 88kV circuit breaker C is an FK-439-1500 type, oil filled breaker. This breaker is of 1949 vintage and is without oil containment. This circuit breaker has exceeded the manufacturer's designed number of full fault operations and General Electric does not provide support for this breaker.
- Currently, 21 of the 23 relays (91% of all station relays) are in need of replacement. There are 19 of the electromechanical type which have no spare part availability and fault data collection and retention. In addition, these relays lack vendor support.
- The Northwest corner of the station has had significant washouts in the past and has damaged the perimeter fence. The washouts have exposed the control cables for the 88kV circuit breaker.
- Carswell is the one of the last two stations that have an operating voltage of 88kV.

AEP Transmission Zone M-3 Process McDowell County, West Virginia

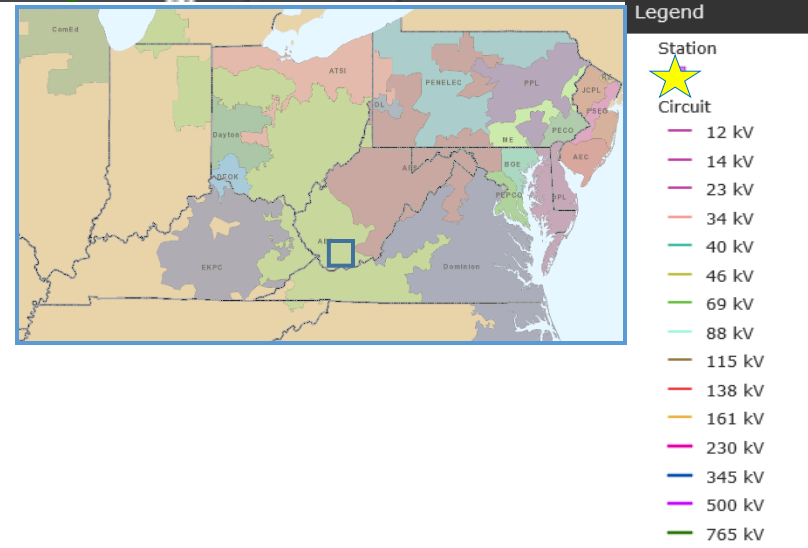
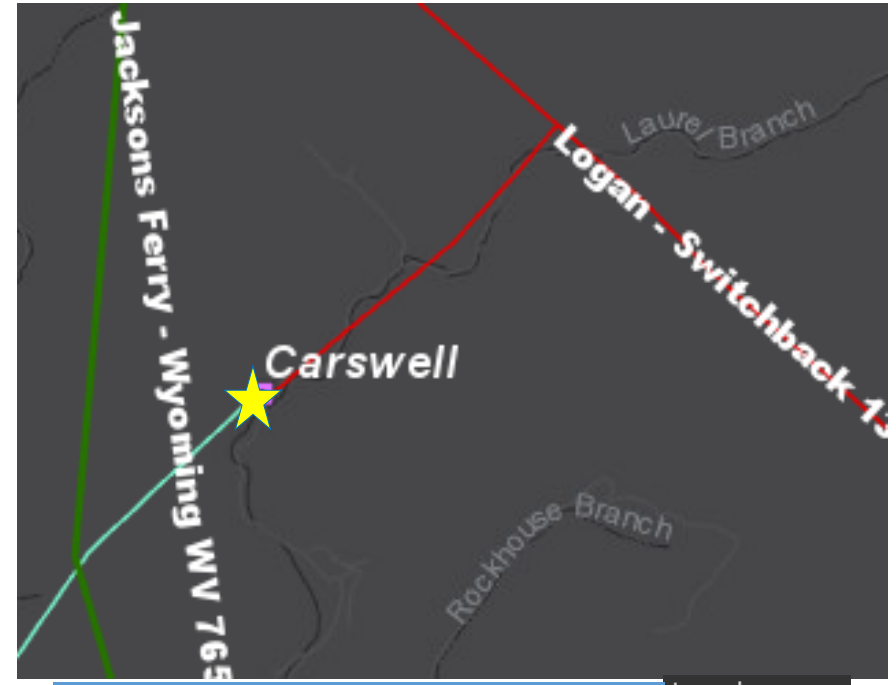

AEP Transmission Zone M-3 Process McDowell County, West Virginia

Need Number: AEP-2022-AP023

Process Stage: Submission of Supplemental Project for inclusion in the Local Plan 3/20/2024

Previously Presented:

Solution Meeting 1/19/2024
Need Meeting 4/22/2022

Supplemental Project Driver: Equipment Condition/Performance/Risk

Specific Assumption Reference:

AEP Guidelines for Transmission Owner Identified Needs (AEP Assumptions Slide 13), AEP’s Pre-1930s Era Lattice Tower and Transmission Line System Report

Problem Statement:

Line Name: Carswell Loop 138kV Line
Original Install Date (Age): All the structures and conductor are from 1927
Length of Line: ~1.4 mi
Total structure count: 5
Original Line Construction Type: Lattice Steel
Conductor Type: 397,500 ACSR
Momentary/Permanent Outages: 25 Momentary and 3 Permanent

Line Conditions:

- The Carswell Loop line asset is hard tapped to the adjacent Logan – Switchback 138kV Line. The associated Tazewell - Trail Fork 138kV Circuit serves 13 MVA of peak load at Belcher Mountain, Carswell, & Clark Branch. Though Belcher Mountain is served at 88kV, it has a radial service from Carswell Substation that is impacted by outages on the Tazewell - Trail Fork 138kV Circuit.
- Since 2017, there have been 25 momentary and 3 permanent outages on the Tazewell – Trail Fork 138kV Circuit. The momentary outages were due to lightning (18), unknown (3), ice/snow (1), wind (1), test shot (1), and other (1) causes. The permanent outages were due to vegetation grow-in (2) and vegetation fall-in from outside of the AEP ROW (1) causes. These permanent outages caused 293k minutes of customer interruption.
- The inadequate shielding angle on this line asset leads to potential poor lightning performance.
- The porcelain insulators on the line do not meet current AEP standards for CIFO and minimum leakage distance requirements.
- Access for this line is extremely difficult due to the steep, mountainous terrain.

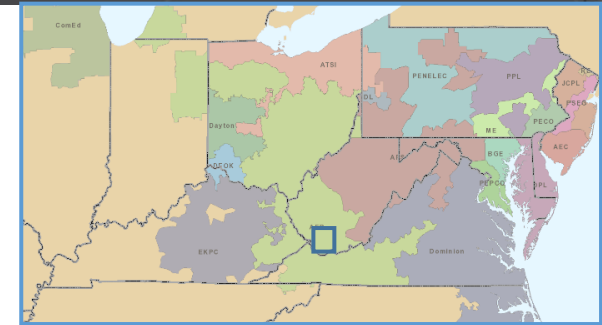



BOUNDLESS ENERGY™

Need Number: AEP-2022-AP024

Process Stage: Submission of Supplemental Project for inclusion in the Local Plan 3/20/2024

Previously Presented:

Solution Meeting 01/19/2024
Need Meeting 4/22/2022

Supplemental Project Driver: Equipment Condition/Performance/Risk

Specific Assumption Reference:

AEP Guidelines for Transmission Owner Identified Needs (AEP Assumptions Slide 13)

Problem Statement:

Line Name: Carswell - Gary 88kV Line
Original Install Date (Age): All the structures and conductor are from 1948
Length of Line: ~2 mi
Total structure count: 12
Original Line Construction Type: Wood
Conductor Type: 336,400 ACSR
Momentary/Permanent Outages: 8 Momentary and 5 Permanent

Line Conditions:

- The associated Carswell - Gary 88kV Circuit was retired when the segment from Belcher Mountain to Gary Substations was removed in 2018.
- From January 1, 2015, to November 11, 2018, there were 8 momentary and 4 permanent outages on the Carswell – Gary 88kV Circuit. The momentary outages were due to lightning (7) and station breaker (1) causes. The permanent outages were due to station breaker (2), lightning (1), and vegetation fall-in from outside of AEP ROW (1) causes. These outages caused 969k minutes of customer interruption.
- Since November 11, 2018, there has been 1 permanent outage on the Belcher Mountain – Carswell 88kV Circuit. This outage caused 105k minutes of customer interruption.
- Currently, there are 5 structures with at least one open structural condition, which relates to 42% of the structures on the line. There are currently 8 open structural conditions specifically affecting the crossarms and poles including rot top, insect damage, woodpecker damage, and broken conditions.
- The structures on the Carswell – Gary 88kV Line fail to meet 2017 NESC Grade B loading criteria, fail to meet current AEP structural strength requirements, and fail to meet the current ASCE structural strength requirements.
- The porcelain insulators on the line do not meet current AEP standards for CIFO and minimum leakage distance requirements.

AEP Transmission Zone M-3 Process McDowell County, West Virginia

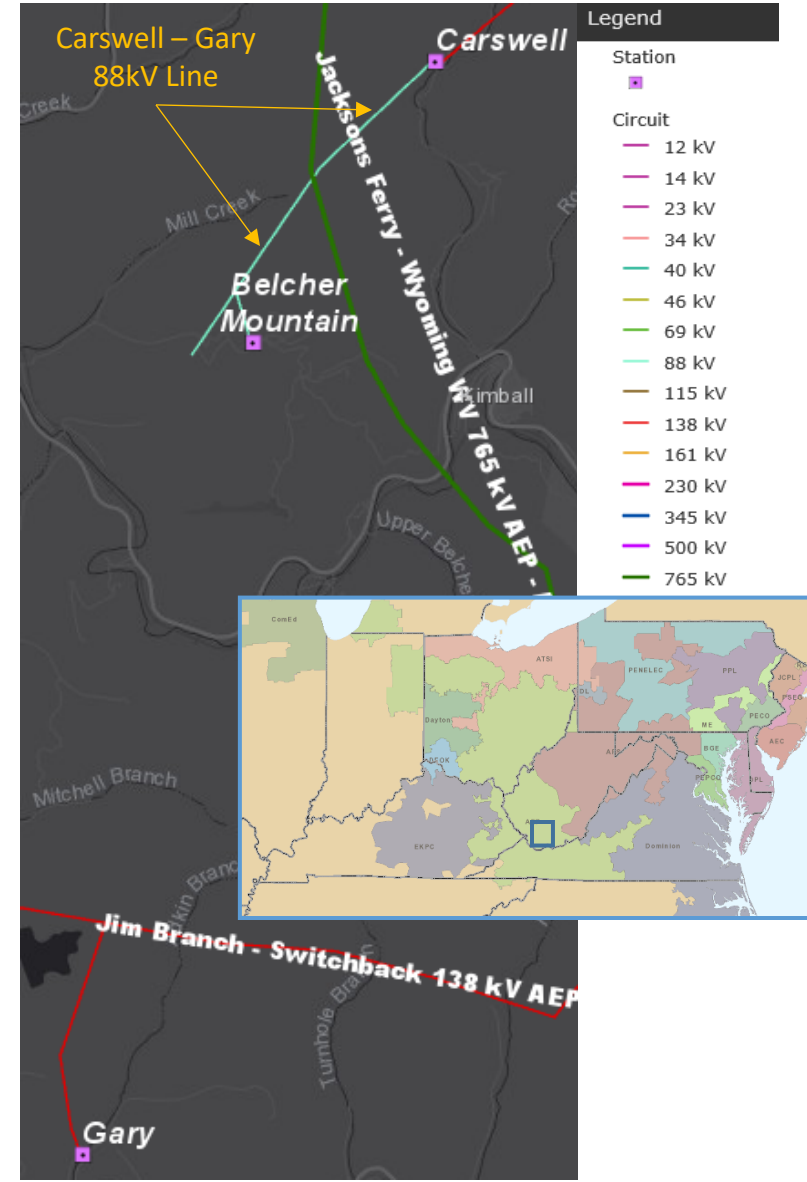

Need Number: AEP-2022-AP024

Process Stage: Submission of Supplemental Project for inclusion in the Local Plan 3/20/2024

Problem Statement Continued:

Line Conditions Con't:

- Customers are radially served at Belcher Mountain by this line from Carswell.
- The butt wrap grounding and typical shield angle is inadequate per current AEP Standards and can cause poor lightning performance. The current grounding system, poor shielding angle, and the electrical strength of the insulators do not meet current AEP and industry accepted criteria, making the line susceptible momentary and permanent outages, affecting customer reliability.
 - The inadequate grounding limits the available path to ground during any type of line fault, increasing the intensity the conductor and related hardware have to withstand during the fault. The reduced electrical strength of the insulators could lead to electrical damage to structures and hardware during a fault if the insulator were to fail from elevated electrical stresses.
 - The line serves a peak load of 4.5 MVA at Belcher Mt. station.

AEP Transmission Zone M-3 Process McDowell County, West Virginia

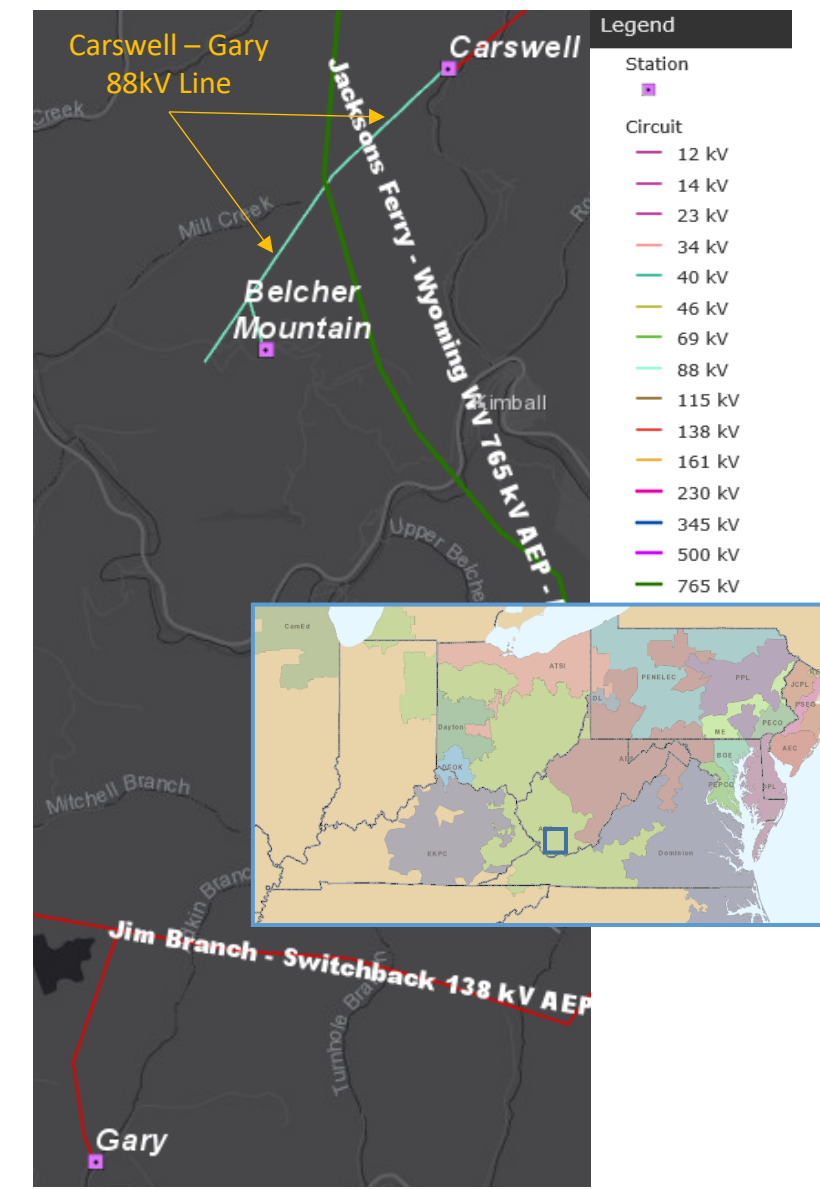

Need Number: AEP-2022-AP025

Process Stage: Submission of Supplemental Project for inclusion in the Local Plan 3/20/2024

Previously Presented:

Solution Meeting 01/19/2024

Need Meeting 4/22/2022

Supplemental Project Driver: Equipment Condition/Performance/Risk

Specific Assumption Reference:

AEP Guidelines for Transmission Owner Identified Needs (AEP Assumptions Slide 13)

Problem Statement:

Belcher Mountain Station:

- The 88/13kV Distribution transformers are 1949 vintage and have low dielectric strength which indicates an increase in particles within the oil, decreasing the ability of the oil to withstand fault events, which can damage the paper insulation. The transformers have poor values of moisture, dielectric strength, and IFT that indicate the dielectric strengths of the insulation systems (oil and paper) are in poor condition, which impairs the units' ability to withstand electrical faults. The transformers have presence of Ethane, Carbon Dioxide, and Carbon Monoxide, along with the indication of overheating faults indicate decomposition of the increasingly brittle and non-thermally upgraded paper insulation.
- The 13kV 1969 vintage circuit breaker A is a PR type, oil filled breaker. This breaker is of 1969 vintage and is without oil containment. This circuit breaker has exceeded the manufacturer's designed number of full fault operations.
- Currently, all 10 relays (100% of all station relays) are in need of replacement. All 10 of these are of the electromechanical type which have no spare part availability and fault data collection and retention. In addition, these relays lack vendor support.
- A small sink hole is developing near the 13kV Bay.
- No remote monitoring of assets is available due to the lack of an RTU.
- Belcher Mountain is the last of two stations that have an operating voltage of 88kV.

AEP Transmission Zone M-3 Process McDowell County, West Virginia

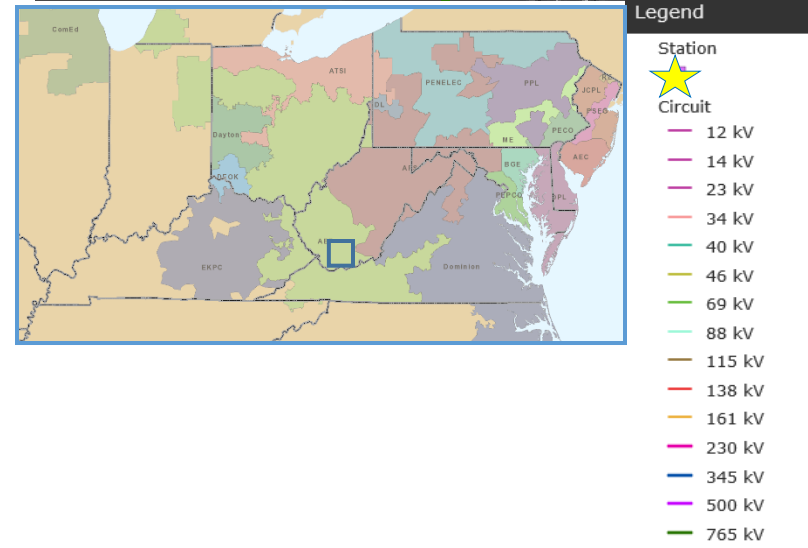
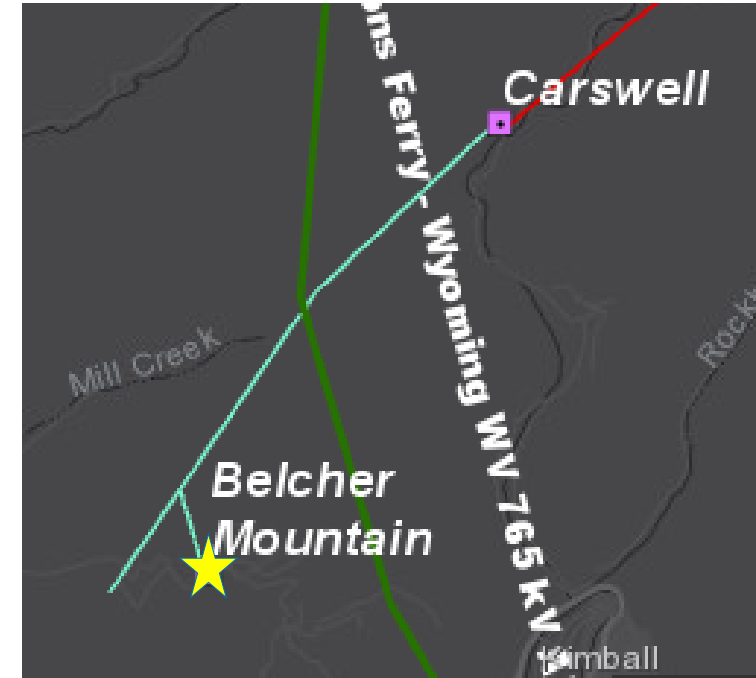

AEP Transmission Zone M-3 Process McDowell County, West Virginia

Need Number(s): AEP-2022-AP022, AEP-2022-AP023, AEP-2022-AP024, AEP-2022-AP025

Process Stage: Submission of Supplemental Project for inclusion in the Local Plan 3/20/2024

Solution:

- A new 138 kV double circuit line extension will be built from the existing Jim Branch – Switchback line between Gary and Thorpe stations to the greenfield Coalfields stations, approximately 2.0 miles, creating an in and out. New right of way is needed from the new tap structure to Coalfields station. The line cost is driven by very steep terrain and the miles of access roads required. The line will require marker balls and helicopter installation due to the valleys and terrain. Estimated Cost: \$13.0M **(s3215.1)**
- The 138kV high side of Coalfields station will be a 138kV straight bus with two automatic MOAB switches. The greenfield station will contain a 138/12 kV 20 MVA transformer with high side circuit switcher. There will be three 12 kV feeders from the station. Distribution work will be required to reconnect the Distribution system to the new Coalfields station. Estimated Cost: \$1.65M **(s3215.2)**
- Work required to tap the existing Jim Branch – Switchback 138kV line asset. Estimated Cost: \$1.8M **(s3215.3)**
- Remote end work required at Trail Fork, Tazewell, Clark Branch and Baileysville stations. Estimated Cost: \$0.38M **(s3215.4)**
- Remove the Transmission station and equipment at Carswell station. Estimated Cost: \$2.86M **(s3215.5)**
- Remove the Carswell 138kV Loop at ~1.4 miles and the Carswell – Gary 88kV Line at ~2.5 miles. Estimated Cost: \$5.15M **(s3215.6)**
- Remove the Distribution station and equipment at Belcher Mountain station. Estimated Cost: \$0.0 (Distribution cost)**(s3215.7)**

Total Estimated Transmission Cost: \$24.84 M

Ancillary Benefits: Consolidation of two Distribution stations into one. Retirement of some of the last 88kV on the AEP system. The Distribution customers will be served from a station that has looped Transmission service. This project also removes a hard tap on the 138 kV system which limits outage response options and presents outage and maintenance challenges.

Projected In-Service: 11/1/2028

Supplemental Project ID: s3215.1-.7

Project Status: Scoping

Existing

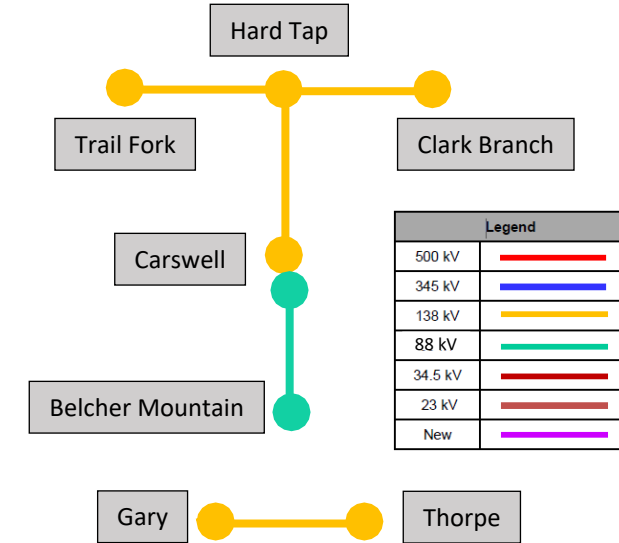

Proposed

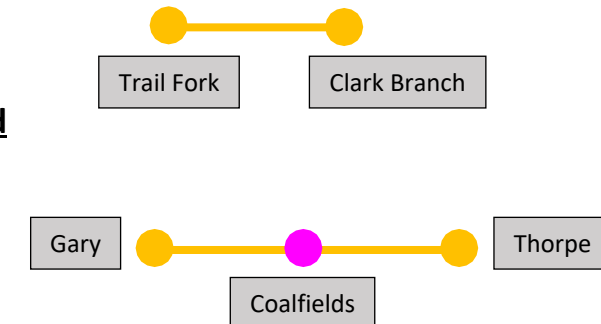

AEP Transmission Zone M-3 Process Licking County, Ohio

Need Number: AEP-2023-OH013

Process Stage: Submission of Supplemental Project for inclusion in the Local Plan 05/20/2024

Previously Presented:

Solutions Meeting 7/21/2023

Need Meeting 1/20/2023

Project Driver: Customer Service

Service Specific Assumption Reference: AEP Connection Requirements for the AEP Transmission System (AEP Assumptions Slide 12)

Problem Statement:

AEP Ohio has requested to add capacity at Mink station, due to continuous load growth in the area. The load requests have exhausted existing capacities at Mink station as well as Etna (OP) station. The anticipated peak load is approximately ~~30~~ 50 MVA. The requested in-service date is ~~November~~ March 2025.

Model: 2025 RTEP

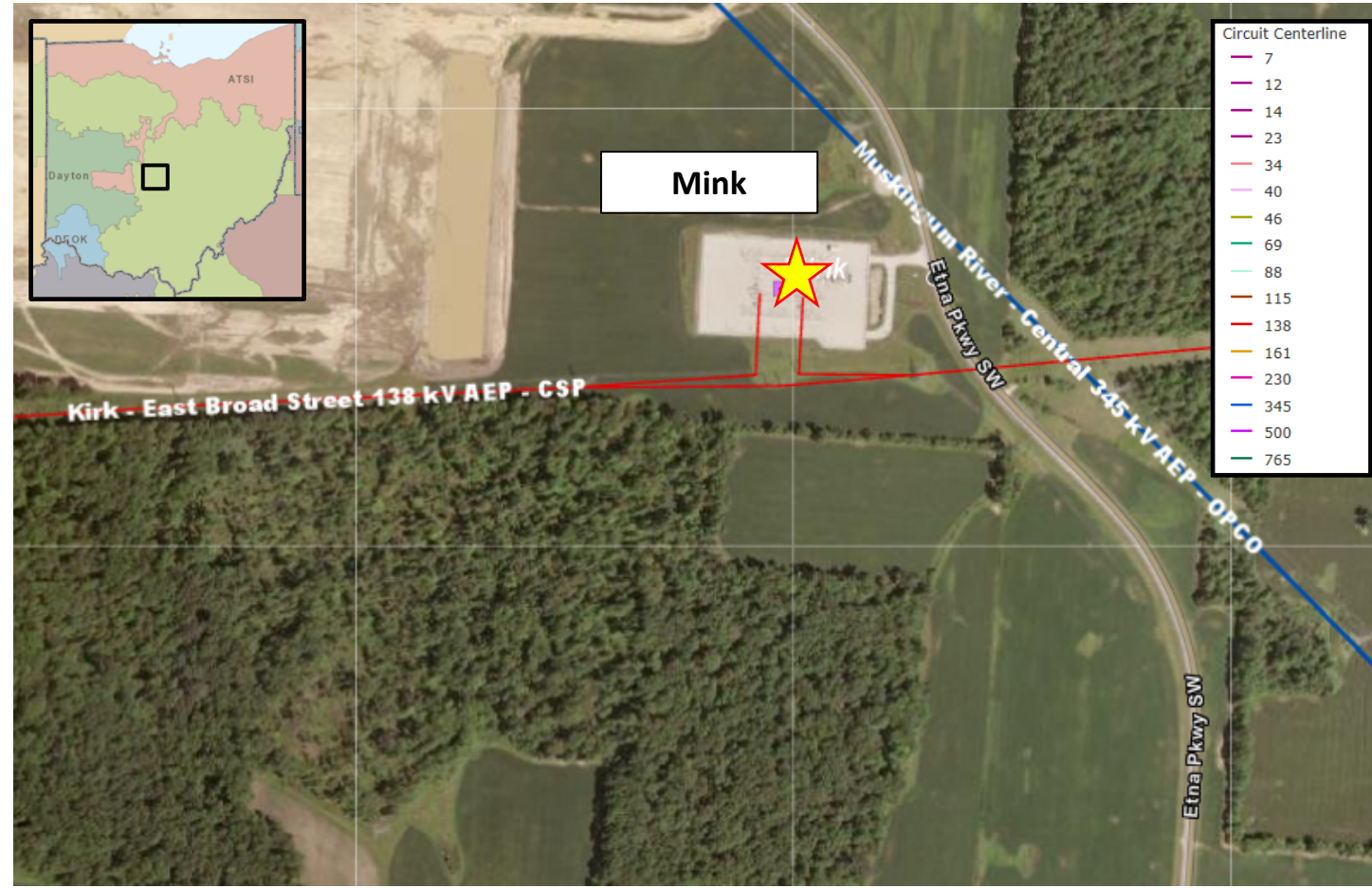

Need Number: AEP-2023-OH013

Process Stage: Submission of Supplemental Project for inclusion in the Local Plan 05/17/2024

Solution:

At Mink station, install 2 – 138kV, 3000 A, 63 kA breakers in the breaker and half configuration and associated work to terminate two new distribution transformers. Estimated Cost: **\$ 2.7M**

Total Estimated Transmission Cost: \$ 2.7M

Projected In-Service: 3/28/2025







Supplemental Project ID: s3301.1

Project Status: Engineering

Model: 2027 RTEP

Existing:



Legend	
500 kV	
345 kV	
138 kV	
69 kV	
34.5 kV	
23 kV	
New	

Proposed:



AEP Transmission Zone M-3 Process Price 69 kV Capacitor Bank Install

Need Number: AEP-2023-IM025

Process Stage: Submission of Supplemental Project for inclusion in the Local Plan May 20, 2024

Previously Presented:

Solution Meeting 2/16/2024

Needs Meeting 11/17/2023

Project Driver: Customer Need

Specific Assumption Reference:

AEP Interconnection Guidelines (AEP Assumptions slide 12)

Problem Statement:

Indiana Michigan Power has requested a load increase of 14 MW at Price station. Total anticipated load to be served at the site is 28MW.

With this load addition, the following transmission criteria violations are observed and will be verified by PJM:

- The N-1 69 kV bus outage at Randolph station causes low voltage violations at Price 69 kV of 0.915 pu.
- The N-1-1 outage of the Selma Parker 138/69 kV transformer and the Randolph 138/69 kV transformer in conjunction with the Price load increase prior to project s2273 (Winchester Area Improvements – Randolph upgrades) going in service, will create low voltage violations for the area. This will be a temporary violation until project s2273 implements Randolph station upgrades to include a 69 kV transformer low side circuit breaker for which the Randolph 138/69 kV transformer outage would not also remove the Randolph 69 kV capacitor bank providing voltage support for the area.

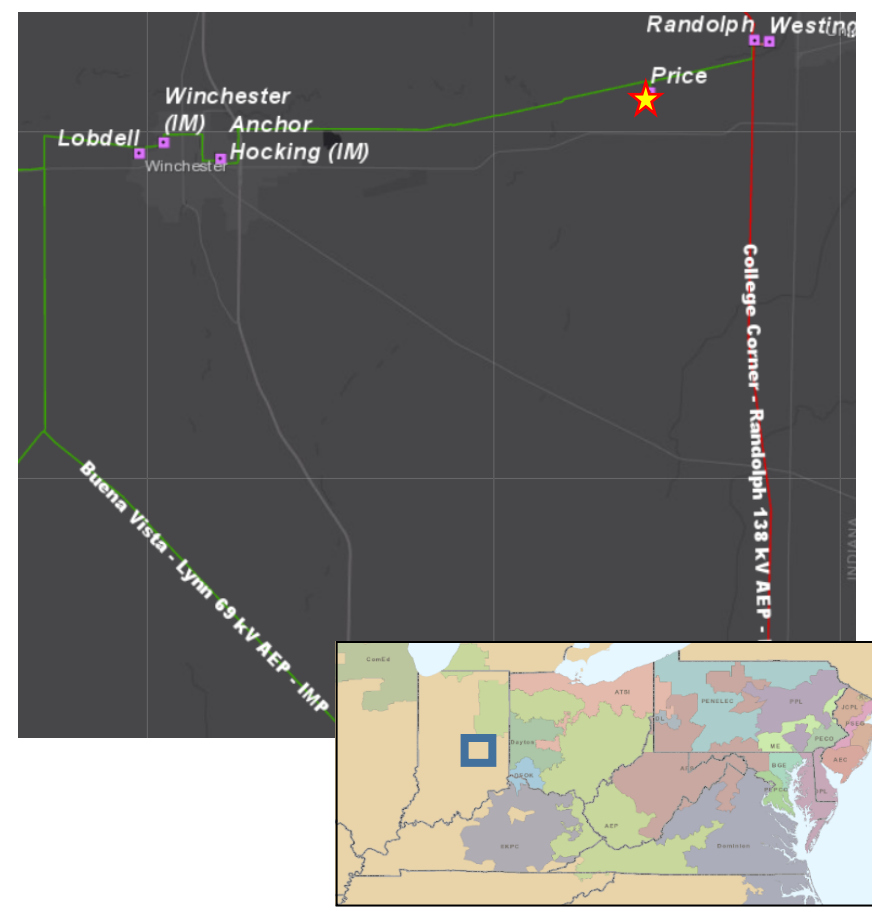
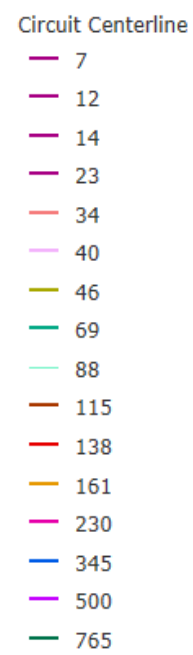

Need Number: AEP-2023-IM025

Process Stage: Submission of Supplemental Project for inclusion in the Local Plan TBD

Solution:

- Install a 69 kV 23 MVAR capacitor bank at Price station and a 69 kV circuit breaker.

Cost: \$ 1.5M (s3302.1)

- Install a temporary, mobile 69 kV 14.4 MVAR capacitor bank at Winchester station to mitigate low voltage violations in the Winchester area. The mobile capacitor bank at Winchester will be removed when project s2273 Randolph upgrades are completed.

Cost: \$ 0.02M (s3302.2)

- Install a 69/4 kV 12.5 MVA transformer and a 69 kV high side circuit switcher.

Cost: \$0 (Distribution cost) (s3302.3)

Total Estimated Transmisson Cost: \$ 1.52M

Projected In-Service: 11/25/2024

Supplemental Project ID: s3302.1-.2

Project Status: Scoping

AEP Transmission Zone M-3 Process Price 69 kV Capacitor Bank Install

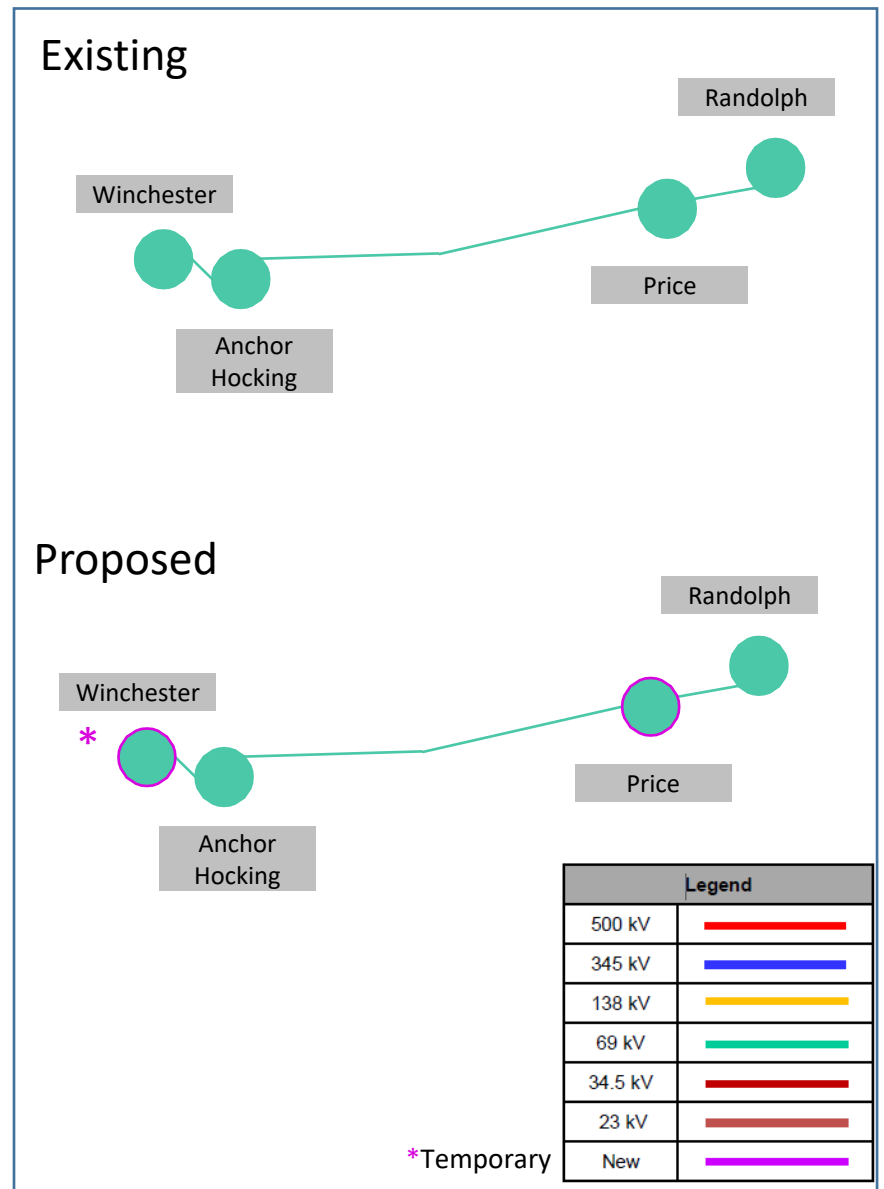

AEP Transmission Zone M-3 Process Pike County, KY

Need Number: AEP-2022-AP034

Process Stage: Submission of Supplemental Project for inclusion in the Local Plan May 20, 2024

Previously Presented:

Solution Meeting 3/15/2024

Need Meeting 06/15/2022

Project Driver:

Customer Service Criteria/ Operational Flexibility and Efficiency

Specific Assumption Reference:

AEP Guidelines for Transmission Owner Identified Needs (AEP Assumptions Slide 11,12 and 14)

Problem Statement:

- A customer has requested service for 20 MW peak load out of the Gund metering location in Pike County, KY.
- Gund metering is an existing delivery point served via a Hard tap from Hatfield - Johns Creek 69kV line. Hard Taps have no switching capability and result in longer restoration times for any outage along the line.

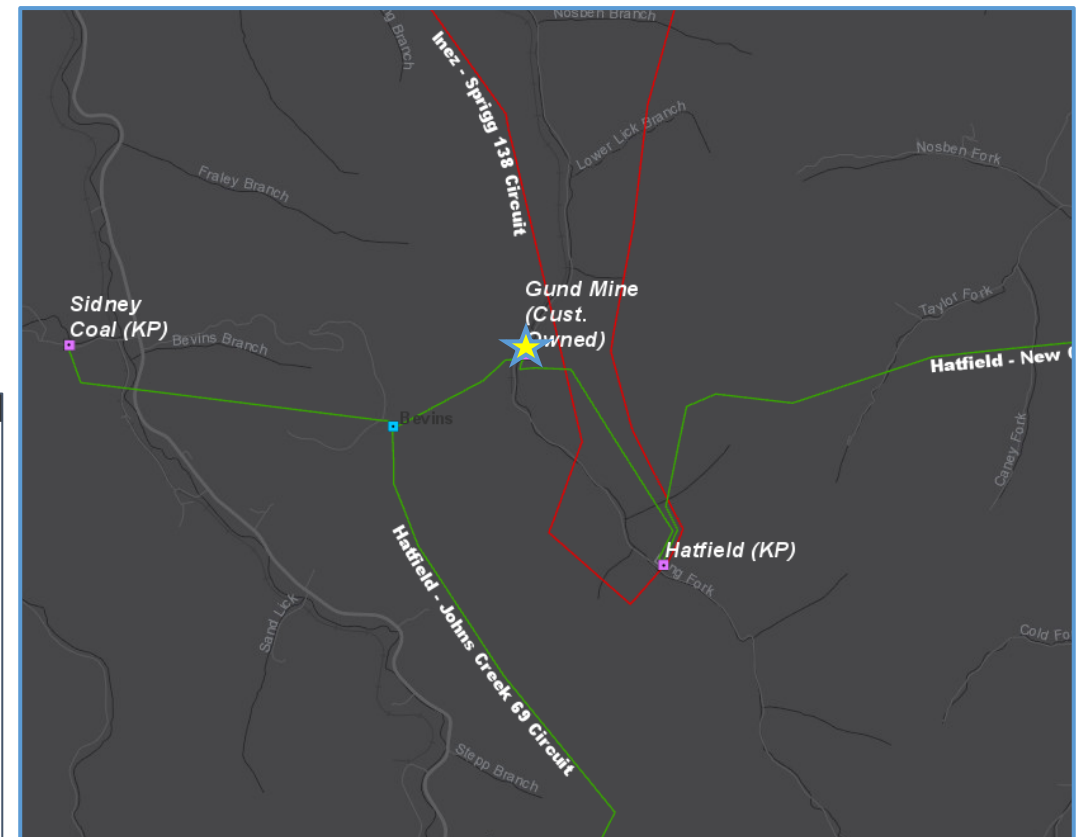
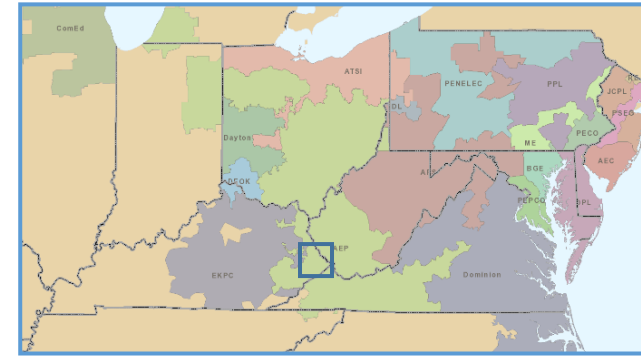

AEP Transmission Zone M-3 Process Pike County, KY

Need Number: AEP-2024-AP001

Process Stage: Submission of Supplemental Project for inclusion in the Local Plan May 20, 2024

Previously Presented:

Solution Meeting 3/15/2024

Need Meeting 02/16/2024

Project Driver:

Customer Service Criteria

Specific Assumption Reference:

AEP Guidelines for Transmission Owner Identified Needs (AEP Assumptions Slide 12)

Problem Statement:

- A customer has requested service for 7 MW peak load out of the Bevins switching station location in Pike County, KY, with proposed in service in 12/2024. The customer has plans to increase the load in the future at this delivery point.

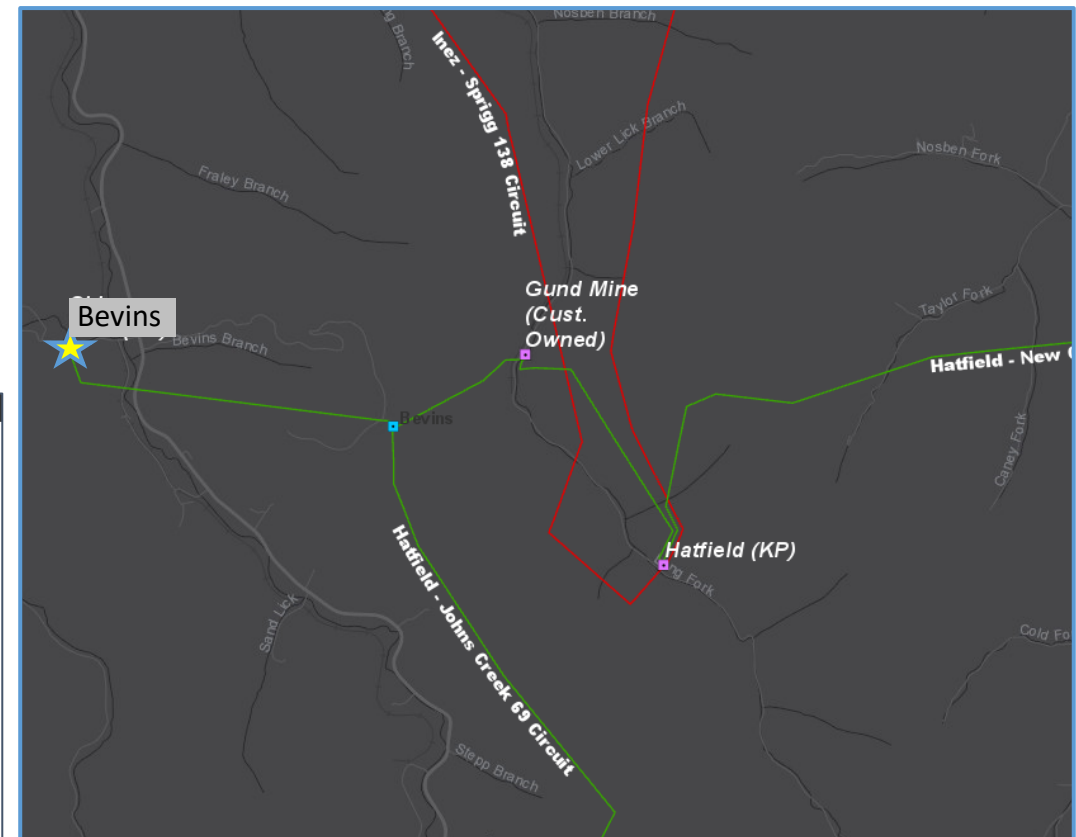
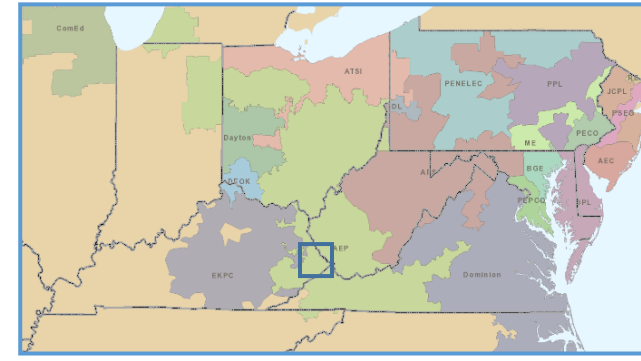

Legend	
Station	★
Circuit	—
	12 kV
	14 kV
	23 kV
	34 kV
	40 kV
	46 kV
	69 kV
	88 kV
	115 kV
	138 kV
	161 kV
	230 kV
	345 kV
	500 kV
	765 kV



Need Number(s): AEP-2022-AP034, AEP-2024-AP001

Process Stage: Submission of Supplemental Project for inclusion in the Local Plan May 20, 2024

Solution:

At Gund Metering Point, install new revenue metering for a 20 MW customer load connection. Install a new 69kV manual switch on the customer side of the hard tap. **Estimated Cost: \$1.15M (s3303.1)**

At Bevins Metering Point, motorize the existing switch at Bevins towards Gund to facilitate the connection of a 7 MW customer load to existing delivery point. **Estimated Cost: \$0.59M (s3303.2)**

Estimated Total Transmission Cost: \$1.74M

Ancillary Benefits: Installation of new SCADA functionality at Bevins adds more sectionalizing capability to the 69kV line.

Projected In-Service: 11/15/2024

Supplemental Project ID: s3303.1-.2

Project Status: Engineering

Model Year: 2025

AEP Transmission Zone M-3 Process Pike County, KY

Existing

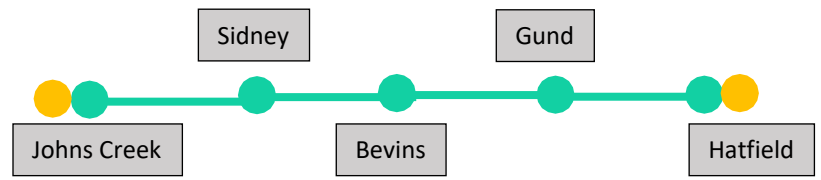

Legend	
500 kV	
345 kV	
138 kV	
69 kV	
34.5 kV	
23 kV	
New	

Proposed

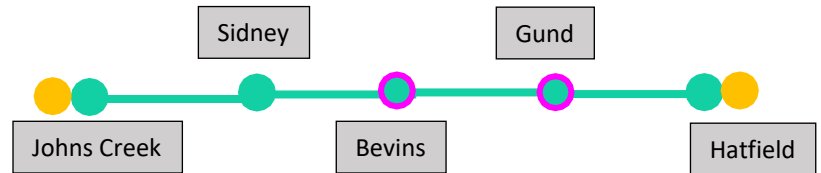

AEP Transmission Zone M-3 Process Markle, Indiana

Need Number: AEP-2023-IM021

Process Stage: Submission of Supplemental Project for inclusion in the Local Plan May 20, 2024

Previously Presented:

- Solutions Meeting 03/15/2024
- Needs Meeting 10/20/2023

Supplemental Project Driver: Customer Need

Specific Assumption Reference: AEP Guidelines for Transmission Owner Identified Needs (AEP Assumptions Slide 13)

Model: 2028 RTEP

Problem Statement:

WVPA has requested a new delivery point for a peak load of 12MW in Markle, Indiana.

Requested ISD: 06/01/2025

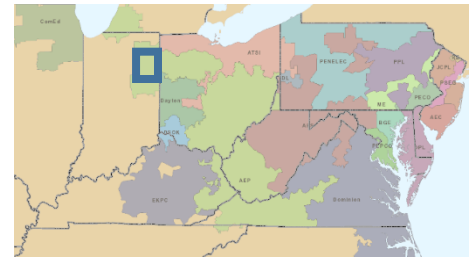
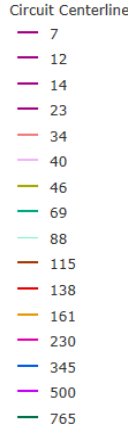

Need Number: AEP-2023-IM021

Process Stage: Submission of Supplemental Project for inclusion in the Local Plan May 20, 2024

Solution:
Install a 3-way phase over phase switch on the Sorenson-Van Buren 138kV circuit. From the new switch, install a ~2.5 mile 138kV line to the customer delivery point. Low-side metering will be installed in the customer owned station. **Estimated Cost: \$9.4 M (s3304.1)**

Total Estimated Transmission Cost: \$9.4 M (s3304.1)

Projected In-Service: 10/1/2026

Supplemental Project ID: s3304.1

Project Status: Scoping

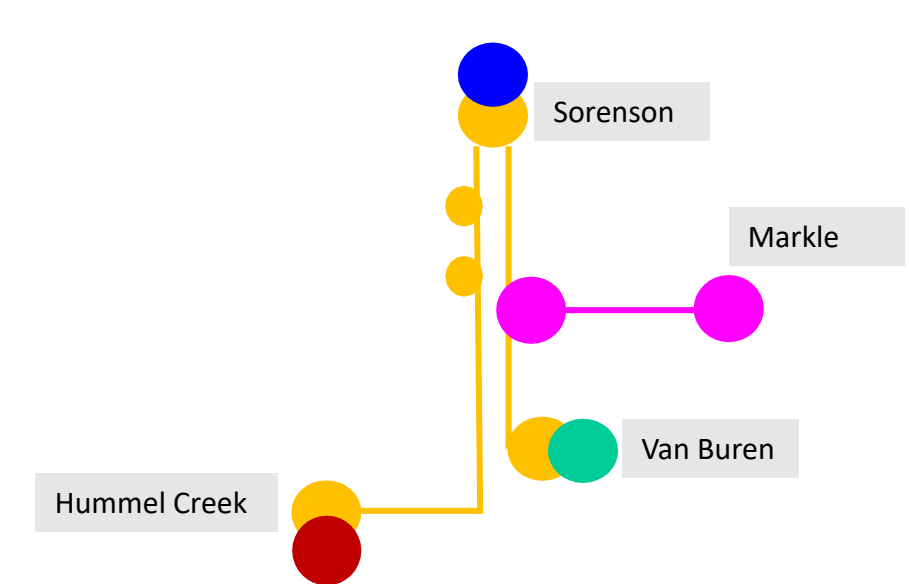
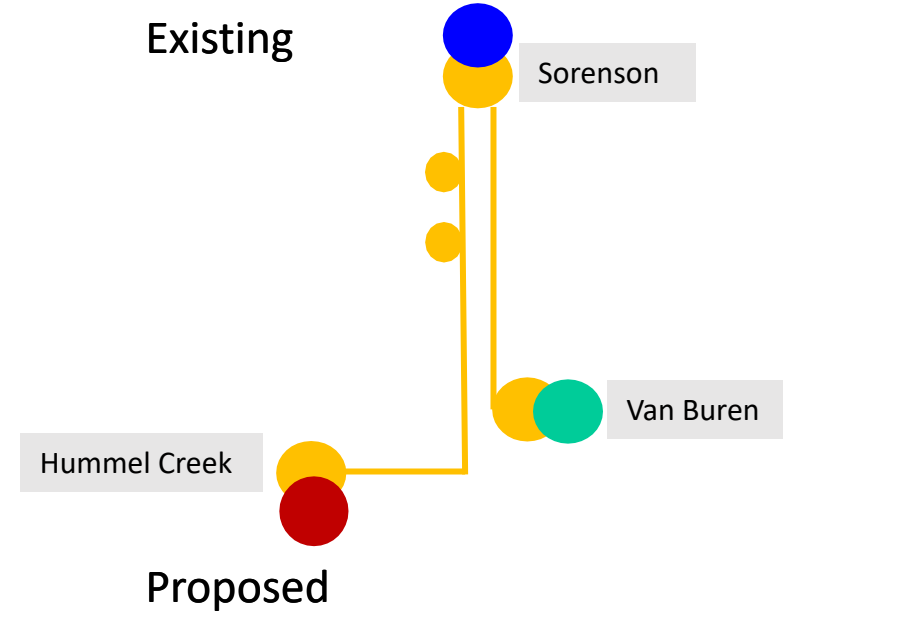

Legend	
500 kV	
345 kV	
138 kV	
69 kV	
34.5 kV	
23 kV	
New	

AEP Transmission Zone M-3 Process Lancaster, Ohio

Need Number: AEP-2023-OH078

Process Stage: Submission of Supplemental Project for inclusion in the Local Plan May 20, 2024

Previously Presented:

Solutions Meeting 03/15/2024

Needs Meeting 10/20/2023

Project Driver: Customer Service

Specific Assumption Reference:

AEP Connection Requirements for the AEP Transmission System (AEP Assumptions Slide 12)

Problem Statement:

- A customer has requested additional transmission service in Lancaster Ohio, near Sifford station.
- Initial project build out supplemental number is s2527.
- The incremental projected demand for the site is 96 MW, bringing the total load for the customer's site to 196 MW.
- Customer requested in-service date of 09/30/2024.

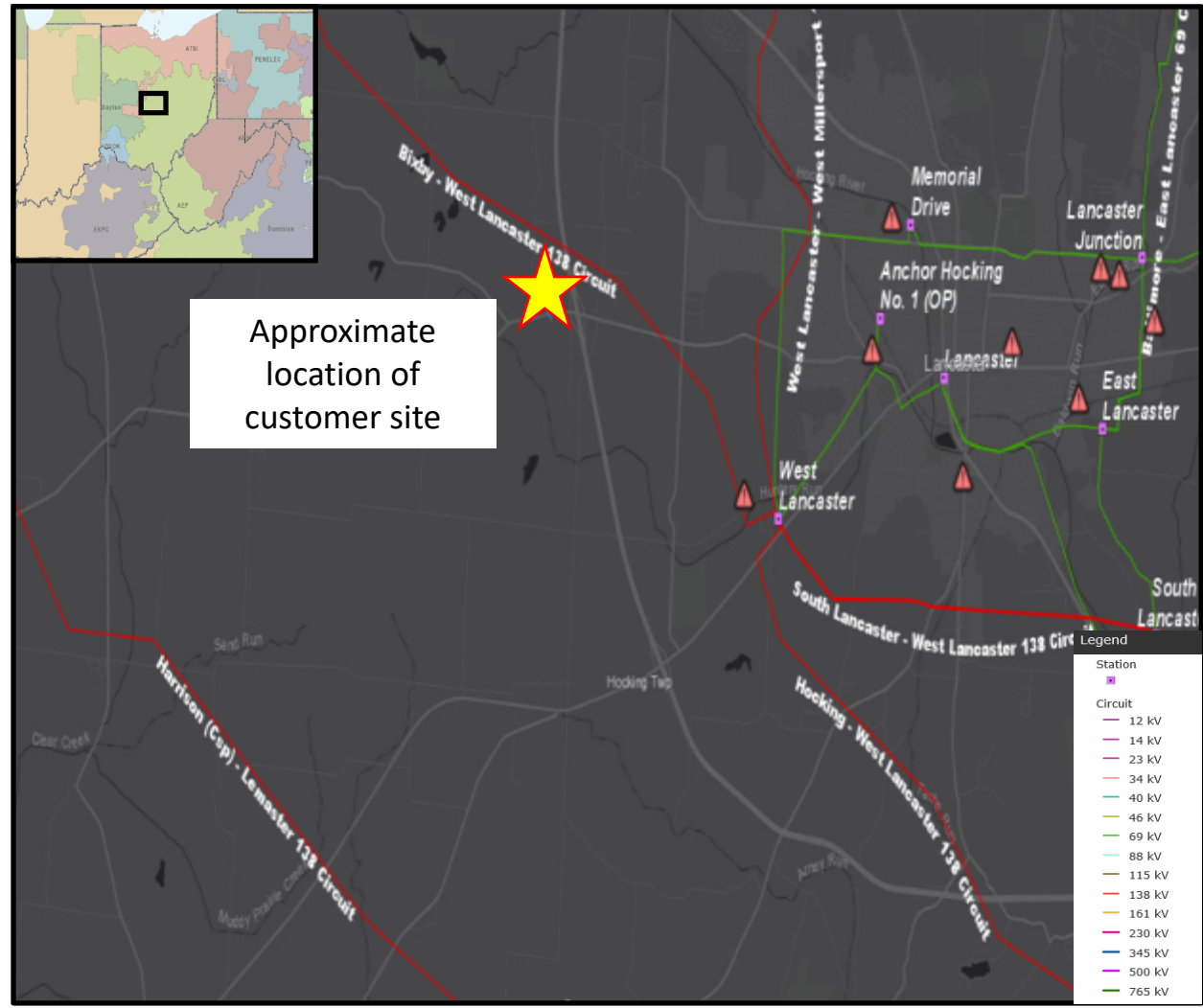

Need Number: AEP-2023-OH078

Process Stage: Submission of Supplemental Project for inclusion in the Local Plan May 20, 2024

Solution:

- **Sifford Station:** Sifford station will be built out to accommodate two new 138 kV feeds to the customer. This will include the installation of 4-3000A 40kA 138 kV circuit breakers and associated equipment. **Estimated Cost: \$6.373M (s3305.1)**
- **Sifford – Ruble #2 138 kV Feed A:** Install 138 kV line extension from AEP’s Sifford station to serve the customer’s station located just south of the Sifford station. **Estimated Cost: \$2.948M (s3305.2)**
- **Sifford – Ruble #2 138 kV Feed B:** Install a second 138 kV line from AEP’s Sifford station to serve the customer’s station located just south of the Sifford station to meet customer’s redundancy requirements at the site. **Estimated Cost: \$0M (fully reimbursable) (s3305.3)**

Total Estimated Cost: \$9.322M

Projected In-Service: 09/30/2024

Supplemental Project ID: s3305.1-.03

Projected Status: Engineering

Model: 2028 RTEP

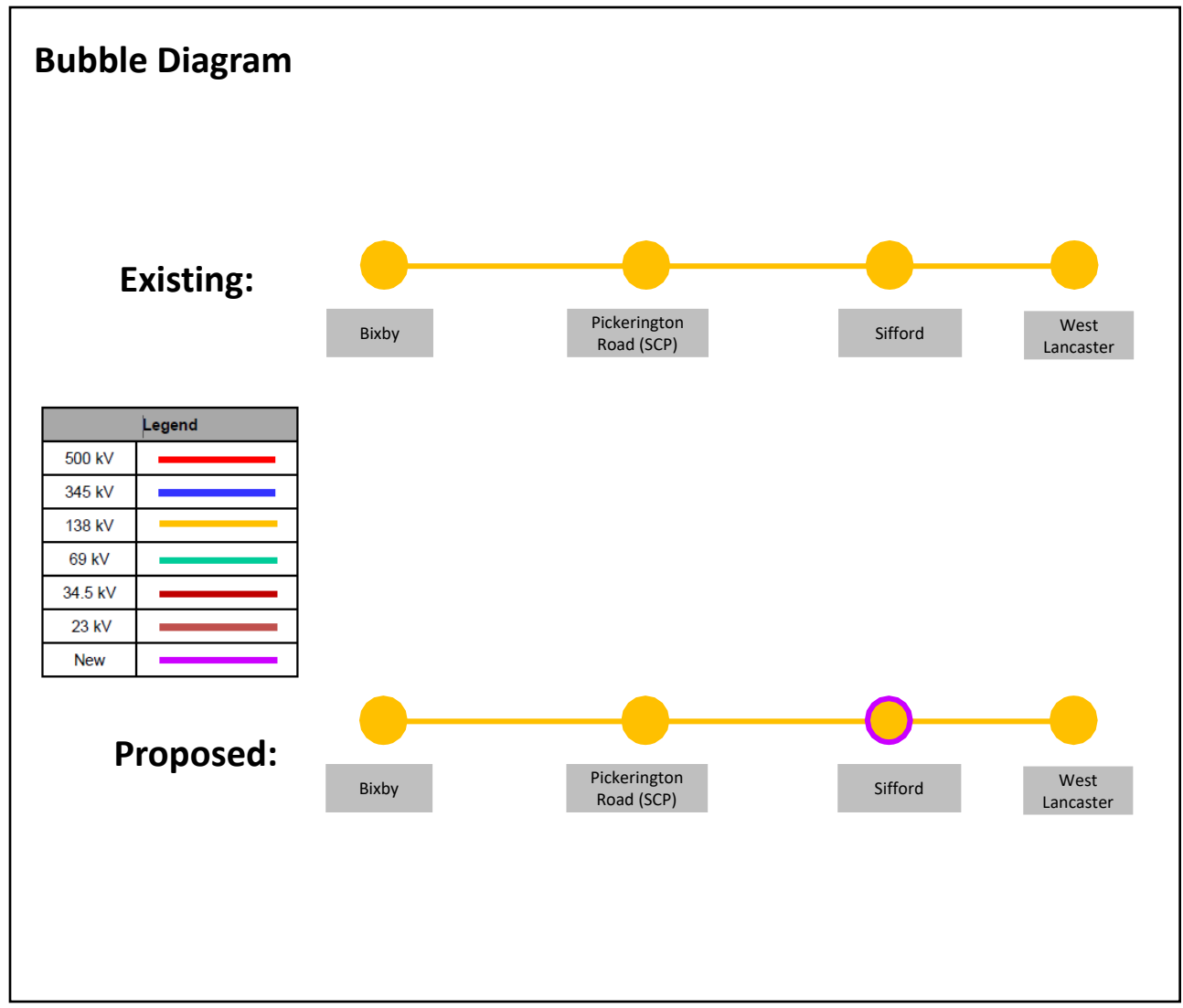

AEP Transmission Zone M-3 Process Roanoke, VA

Need Number: AEP-2024-AP002

Process Stage: Submission of Supplemental Project for inclusion in the Local Plan May 20, 2024

Previously Presented:

Solutions Meeting 3/15/2024

Need Meeting 2/16/2024

Project Driver:

Equipment Condition/Performance/Risk, Operational Flexibility

Specific Assumption Reference:

AEP Guidelines for Transmission Owner Identified Needs (AEP Assumptions Slide 13, 14)

Problem Statement:

Huntington Court Station:

- 69 kV Circuit Breakers
 - E, H and M are all 1994 vintage, 72PM31-20 type, SF6 circuit breakers. Circuit breakers of this type across the AEP system have had reports of moisture ingress into the breaker tank. This moisture ingress leads to increased maintenance and a higher risk of failure. These breakers have documented issues with failures to close due to burned up coils. There have been five catastrophic failures involving this model type across the AEP system. As the components of these units age and become brittle like the O-rings and gaskets, SF6 leaks become more prevalent.
 - Two of these circuit breakers, E and M, have exceeded the manufacturer’s designed number of full fault operations (13 and 9 respectively, with 6 being the manufacturer’s recommended maximum).
 - CB-M has a documented malfunction for an SF6 leak.
- Relaying
 - Huntington Court currently deploys 82 relays, implemented to ensure the adequate protection and operation of the substation. Currently, 45 of the 82 relays (55% of all station relays) are in need of replacement. Of these, 40 of these are of the electromechanical and static type which have significant limitations with regards to spare part availability and fault data collection and retention. These relays lack vendor support. In addition, there are 5 legacy microprocessor based relays that need replaced.
- Operational Flexibility and Efficiency
 - 69/12 kV Transformer #2 does not have a high side circuit switcher or high side breaker. Faults on this bank temporarily outage the 69 kV Bus #2 and there is no low-side load breaking device.
 - 69/34.5 kV Transformer #4 utilizes low-side hookstick vacuum bottle switches. Circuit breakers or vacuum bottle MOABs are recommended to allow for proper sectionalizing.

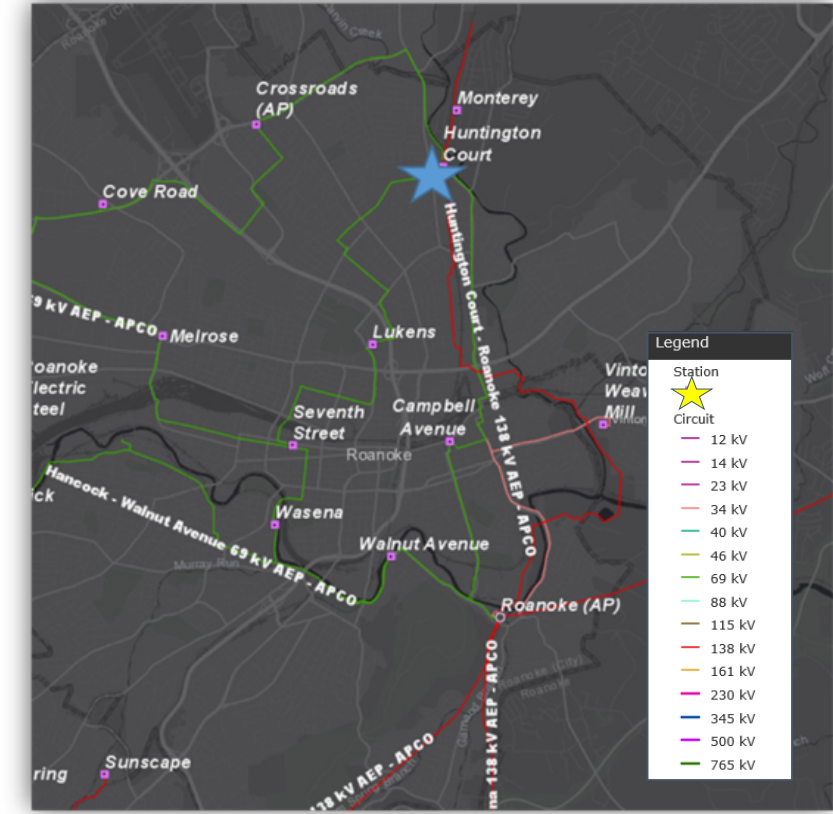
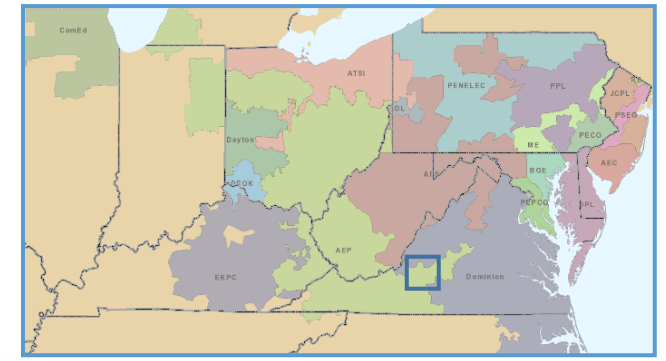

Need Number: AEP-2024-AP002

Process Stage: Submission of Supplemental Project for inclusion in the Local Plan May 20, 2024

Solution:

Huntington Court Station:

- Replace 69 kV circuit breakers “E”, “H”, and “M” and previously identified electromechanical and legacy microprocessor relaying. Install high-side circuit switcher on 138/12 kV T2 and low-side breaker on 138/34.5 kV T4. **Estimated Cost: \$0 (Distribution) (s3306.1)**

Total Estimated Transmission Cost: \$0

Ancillary Benefit:

- Will coordinate with work being performed under baseline project b3289.2 to install a circuit switcher on T1 to minimize outage impact.

Projected In-Service: 11/30/2025

Supplemental Project ID: s3306.1

Project Status: Scoping

AEP Transmission Zone M-3 Process
Roanoke, VA

Station Work Only

No Bubble Diagram Needed

Need Number: AEP-2024-AP003

Process Stage: Submission of Supplemental Project for inclusion in the Local Plan May 20, 2024

Previously Presented:

Solutions Meeting 3/15/2024

Need Meeting 2/16/2024

Project Driver:

Customer Service

Specific Assumption Reference:

AEP Guidelines for Transmission Owner Identified Needs (AEP Customer Service Slide 12)

Problem Statement:

Rich Acres Station:

There are 4 industrial/manufacturing customers, totaling approximately 12.9 MW of load, served out of Rich Acres Station. These customers have experienced 7 Transmission outages in 2023. The customers have asked AEP to investigate. Due to the nature of the load served at Rich Acres, any outage is costly and time consuming to recover from, resulting in lost product for these facilities. Today, there is no fault interrupting devices at the station to help protect customers from outages.

AEP Transmission Zone M-3 Process Ridgeway, VA

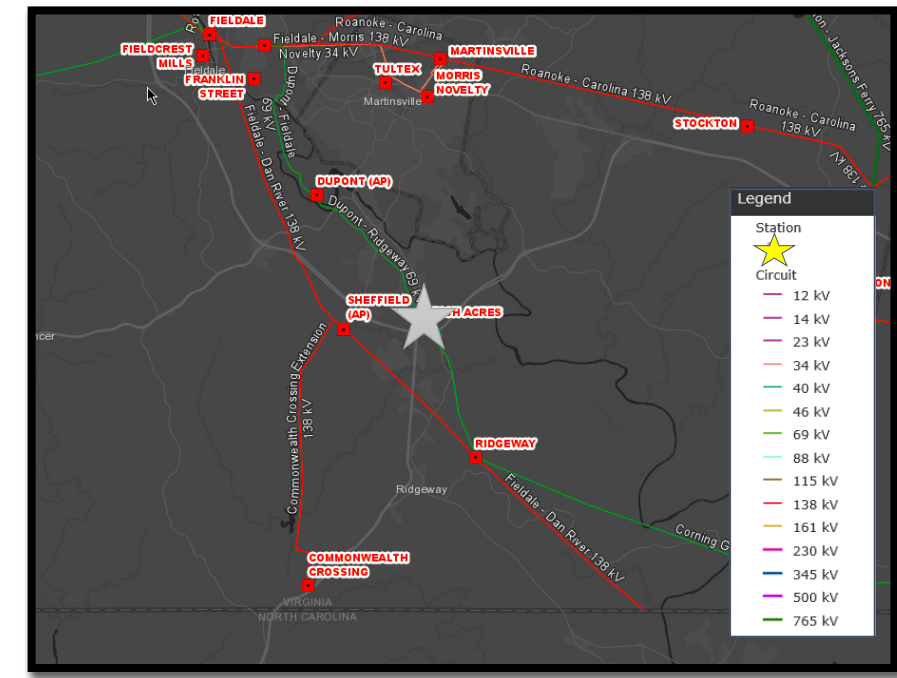
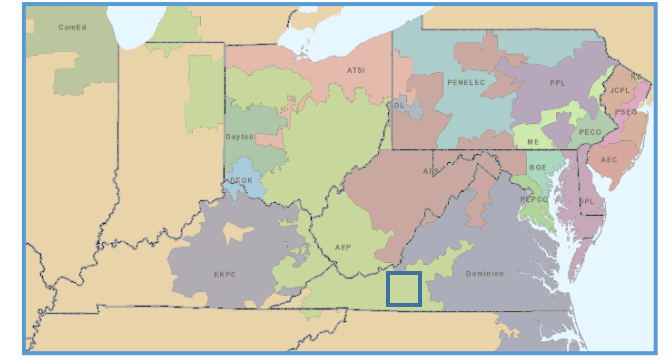

Need Number: AEP-2024-AP003

Process Stage: Submission of Supplemental Project for inclusion in the Local Plan May 20, 2024

Solution:

- Replace existing 69 kV MOABs “W” and “Y” with new 69 kV circuit breakers, new 69 kV box bay and transclosure to house the new relaying. **Estimated Cost: \$0 (Distribution) (s3307.1)**
- The existing 69 kV MOAB switch is located on the opposite side of the street from the station requiring a new 69 kV “in and out” line extension (two spans, separate structures) from the existing line to the new 69 kV box bay. **Estimated Cost: \$1.4 M (s3307.2)**

Total Estimated Transmission Cost: \$1.4 M

Projected In-Service: 06/17/2025

Supplemental Project ID: s3307.1-.2

Project Status: Scoping

Model: N/A

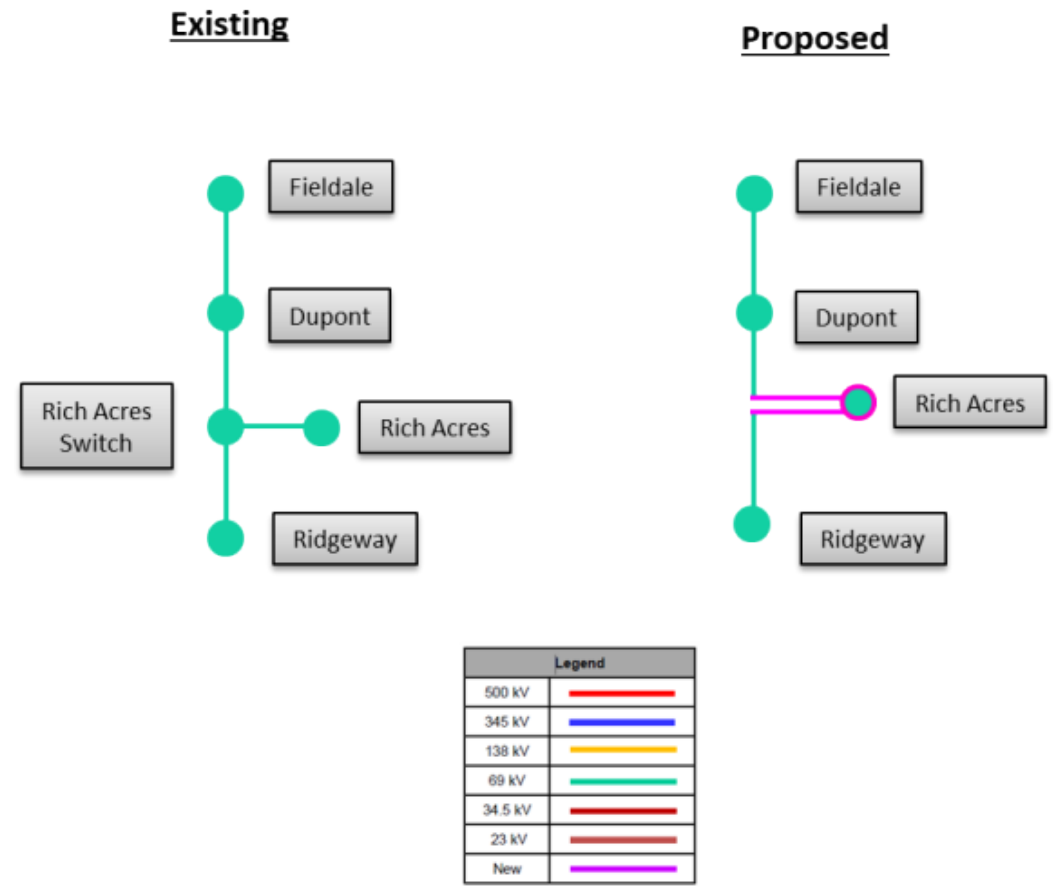

Need Number: AEP-2024-OH029

Process Stage: Submission of Supplemental Project for inclusion in the Local Plan May 20, 2024

Previously Presented:

Solutions Meeting 03/15/2024

Needs Meeting 02/16/2024

Project Driver: Equipment Material/Condition/Performance/Risk

Specific Assumption Reference:

AEP Connection Requirements for the AEP Transmission System (AEP Assumptions Slide 13)

Problem Statement:

Line Name: West Lancaster - South Baltimore - West Millersport 138 kV Line

- Original Install Date (Age): 1954
- Length of Line: 14.4 miles
- Total structure count: 104 of Pole Wood & Pole Steel
 - Wood: 50 from 1950s, 7 from 1960s, 5 from 1970s, 10 from 1980s, and 3 from 1990s.
 - Steel: 29 from 2010s
- Conductor Type: 14.4 miles of 397,500 CM ACSR 30/7 (Lark) from 1954.

Open Conditions:

Currently, there are ~~90~~ **58** unique structures with at least one open condition, which relates to ~~86.5%~~ **55.7%** of the structures on the line. There are currently ~~102~~ **112** structures related open conditions including rot, woodpecker, damaged, cracked, loose, vines, split, disconnected, and insect damaged conditions. There are ~~2~~ **3** conductor related open conditions related to broken strands. There are currently 8 open conditions related to broken ground lead wires. There are also 17 hardware related open conditions including broken and missing molding, damaged guy wires, missing guy guards, and burnt and broken insulators.

AEP Transmission Zone M-3 Process West Lancaster – West Millersport 138 kV

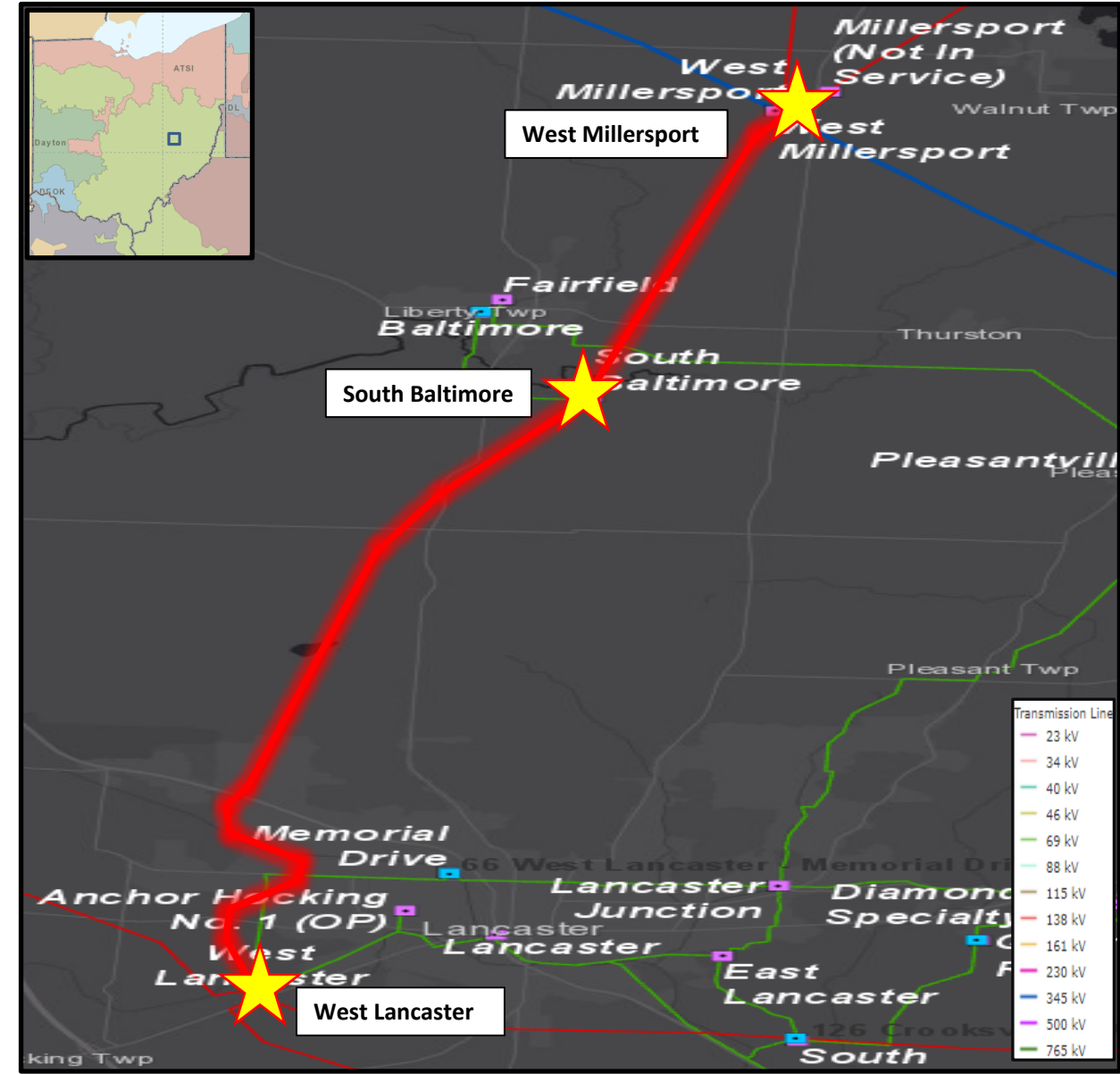

AEP Transmission Zone M-3 Process West Lancaster – West Millersport 138 kV

Need Number: AEP-2024-OH029

Process Stage: Submission of Supplemental Project for inclusion in the Local Plan May 20, 2024

Solution:

- **West Lancaster – South Baltimore – West Millersport 138 kV :** Rebuild ~14.4 miles of the line between West Lancaster and West Millersport stations using 1033 ACSS 54/7 conductor. **Estimated Cost: \$38.7M (s3308.1)**
- **West Lancaster Station:** Replace existing bus and line risers at the station, upgrade line relays. **Estimated Cost: \$1.0M (s3308.2)**
- **South Baltimore Station:** Replace existing bus and line risers at the station, upgrade line relays. While at the station some additional site concerns such as the existing fence will be addressed. **Estimated Cost: \$0.7M (s3308.3)**

Total Estimated Cost: \$40.4M

Projected In-Service: 10/31/2026

Supplemental Project ID: s3308.1-.3

Projected Status: Scoping

Model: 2028 RTEP

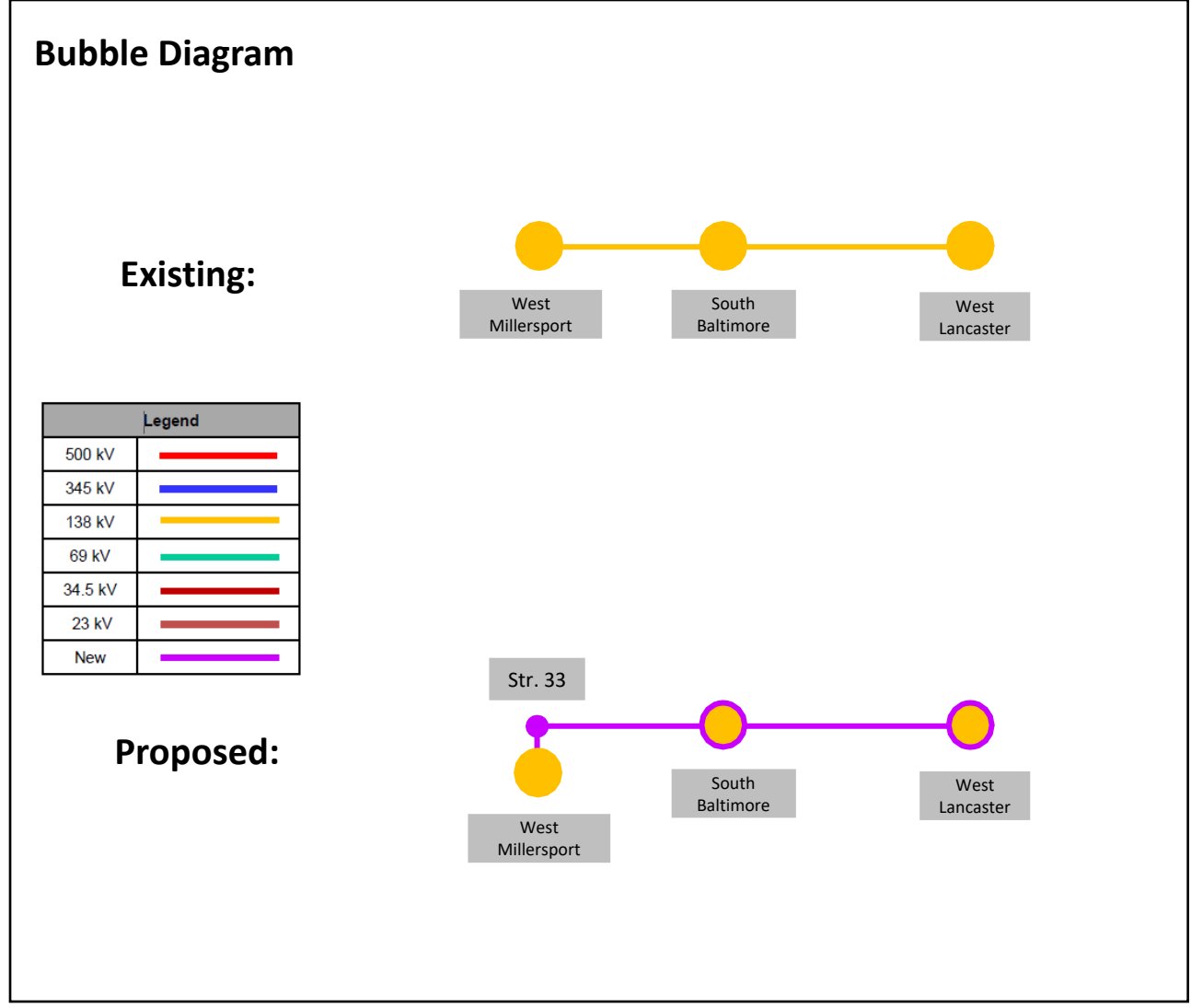

Need Number: AEP-2021-AP025

Process Stage: Submission of Supplemental Project for inclusion in the Local Plan September 4, 2024

Previously Presented: Solutions Meeting 5/17/2024
Need Meeting 6/15/2021

Project Driver: Equipment Condition/Performance/Risk

Specific Assumption References:
AEP Guidelines for Transmission Owner Identified Needs (AEP Assumptions Slide 13)

Problem Statement:

Station Name: Wolf Hills

Circuit Breakers A, B, C & D (138 KV) Concerns:

- All of these breakers are HVB145-40000 type, SF6 filled. These breakers are 2000 (CBs B, C, & D) and 2001 (CB A) vintage and manufactured by GE-Hitachi.
- This type of CB requires maintenance beyond the typical SF6 model type because of air trip mechanisms. The entire air system must be rebuilt whenever maintenance is performed resulting in significant costs.
- The HVB145 model family has the propensity to mechanically pump closed instead of locking open as it awaits an electrical close command from the relaying. This presents a high mis-operation risk on the system.
- All of these breakers have exceeded or met the manufacturer’s designed number of full fault operations of 10 - Breakers A, B, C, and D have experienced 43, 35, 12, and 10 fault operations, respectively. While each of these fault operations is likely not at the full fault current rating of the circuit breakers, fault operations of any magnitude come with accelerated aging.
- Environmental concerns: The HVB circuit breaker model used in this station has a high occurrence of SF6 gas leaks. There have been 215 malfunction records of “Low Gas” or “Adding SF6” across the AEP System. This is an environmental concern since SF6 is a potent greenhouse gas with a high climate change potential, and its concentration in the earth’s atmosphere is rapidly increasing.

Relay concerns:

- Currently, 25 of the 33 relays (76% of all station relays) are in need of replacement.
- There are 12 electromechanical and 3 static type relays which have significant limitations with regards to fault data collection and retention, lack sufficient spare part availability, and lack vendor support. There are 10 microprocessor relays that utilize obsolete firmware.

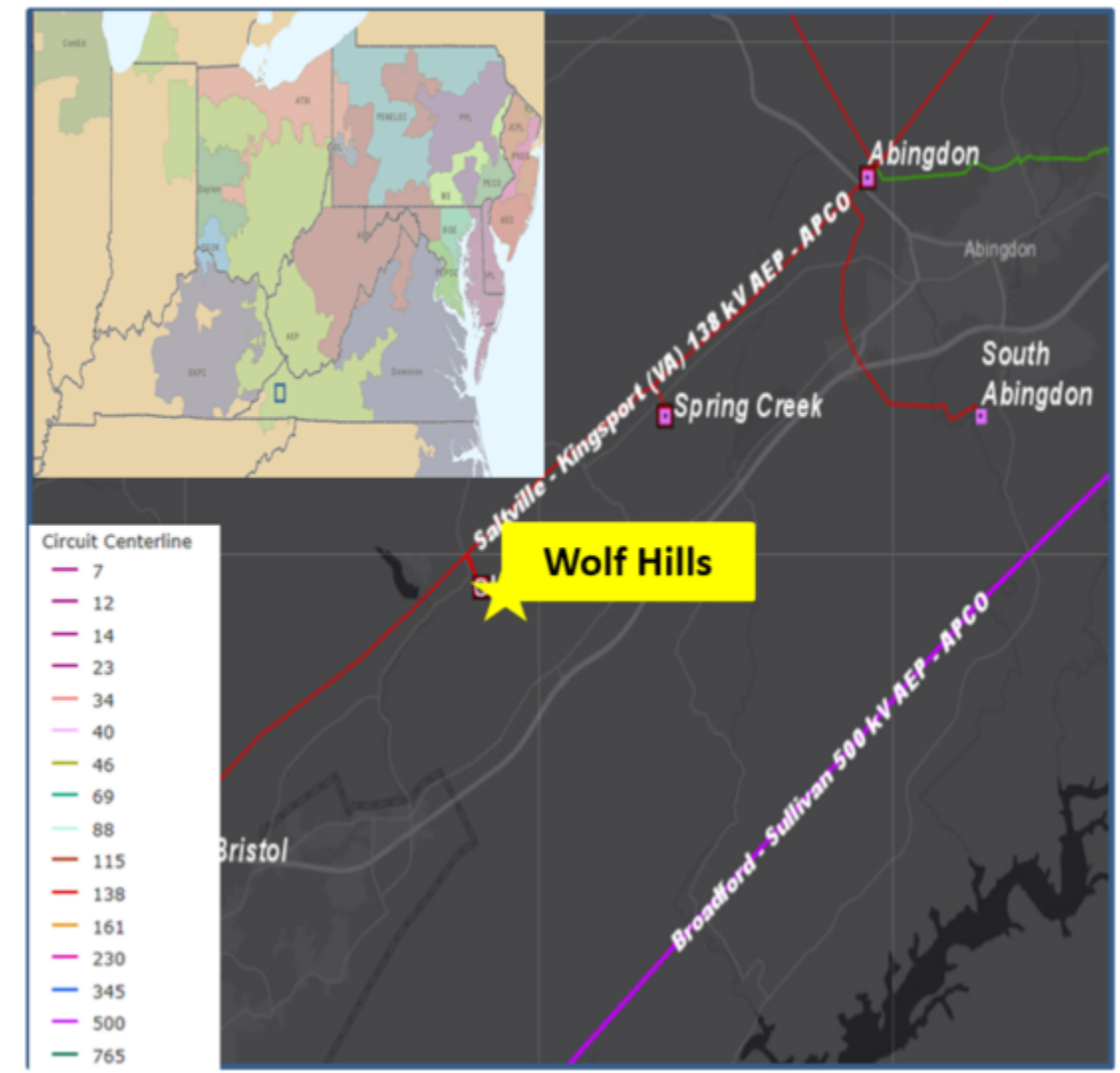

Need Number: AEP-2021-AP025

Process Stage: Submission of Supplemental Project for inclusion in the Local Plan September 4, 2024

Proposed Solution:

Wolf Hills Breaker Replacements: Replace existing 138 kV circuit breakers A, B, C, and D with four new 138 kV 3000 A 40 kA circuit breakers and install a new 138 kV 3000 A 40 kA circuit breaker between Wolf Hills 138 kV Bus #1 and Wolf Hills 138 kV Bus #2. Upgrade control house and install primary and backup station service. **(S3387.1)**

Transmission Cost Estimate: \$5.3 M

Alternatives Considered: Rebuild Wolf Hills Station and reconfigure the 138 kV yard into an 8 breaker ring bus configuration. This would require station expansion which is not feasible in the current location and rebuilding completely in the clear would be cost prohibitive.

Projected In-Service: 9/10/2027

Project Status: Scoping

Supplemental Project ID: s3387.1

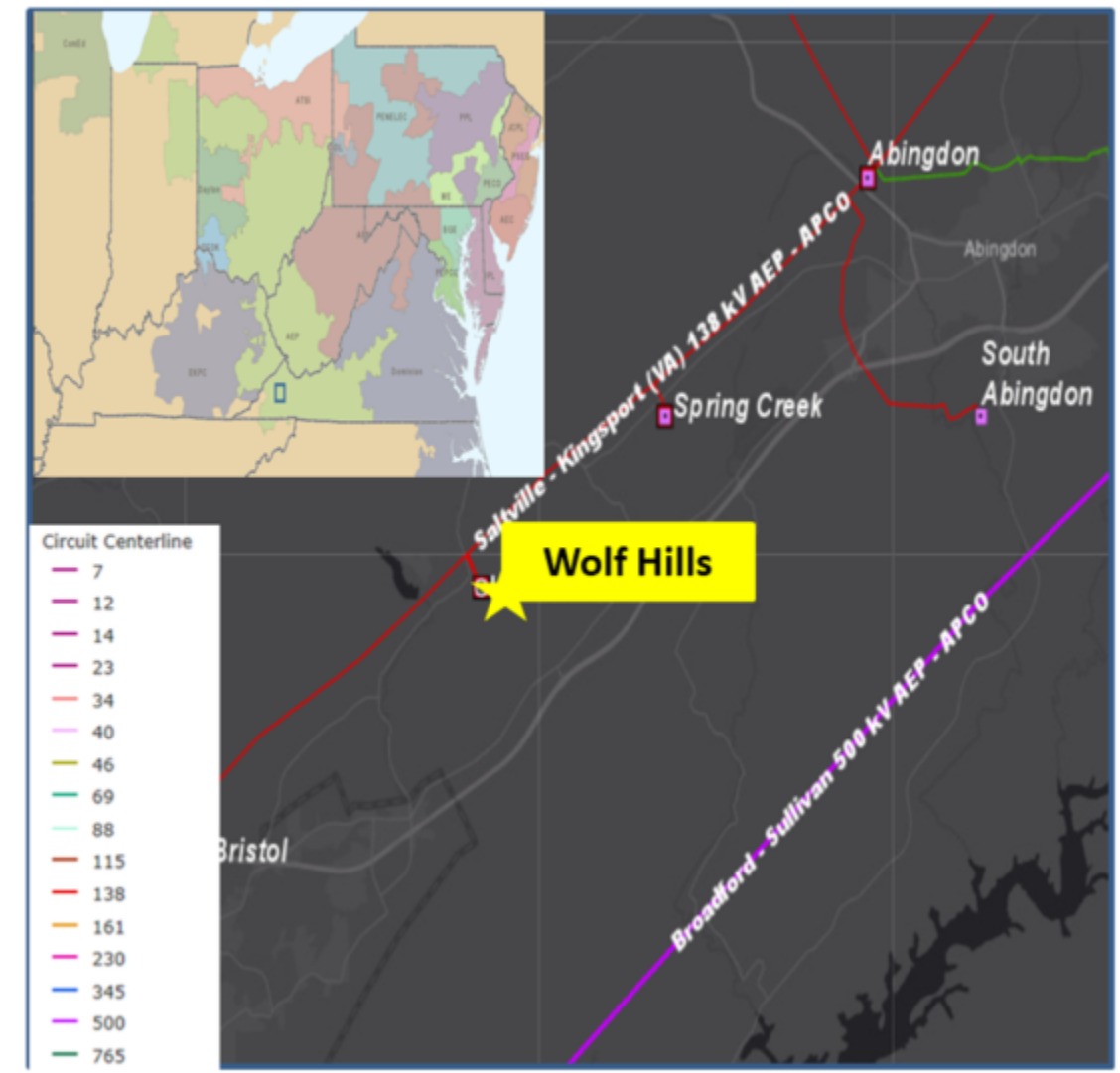

Need Number: AEP-2023-AP024

Process Stage: Submission of Supplemental Project for inclusion in the Local Plan September 4, 2024

Previously Presented: Solutions Meeting 5/17/2024

Need Meeting 10/20/2023

Project Driver: Customer Service

Specific Assumption References:

AEP Connection Requirements for the AEP Transmission System (AEP Assumptions Slide 12)

Problem Statement:

Customer Service:

- Coronado Global Resources Inc. has requested new delivery point for their facility at Jones Fork Rd, Buchanan County, VA.
- The anticipated Peak load for this facility is 2 MW (future possible load ramp of up to 5MW).
- The customer has requested an ISD of 06/01/2024.



Need Number: AEP-2023-AP024

Process Stage: Solutions Meeting 5/17/2024

Proposed Solution:

Raikes Branch Metering Install: Remove an existing wood pole structure on the Raikes Branch customer delivery line and install a new pole that will have the new metering equipment. This cost is reimbursable from the customer; the previous delivery point switches are still in good condition and do not need replaced. **(s3388.1)**

Estimated Cost: \$0 M

Ancillary Benefit: This solution is able to reuse an existing phase over phase switch to connect the 2 MW load request. The Raikes Branch delivery point is currently unused after a previous customer discontinued operation.

Alternatives Considered:

Install a new 69kV phase over phase switch for the customer delivery point on a different location on the line. Considering the existing switch that's available for use and the location of the customer request, this option was not pursued. Further, a new switch installation would be more costly.

Projected In-Service: 10/3/2024

Project Status: Engineering

Supplemental Project ID: s3388.1

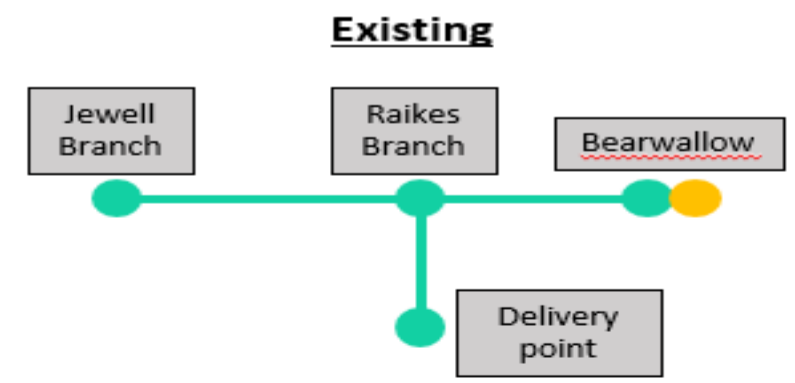

Legend	
500 kV	Red line
345 kV	Blue line
138 kV	Yellow line
69 kV	Green line
34.5 kV	Red line
23 kV	Red line
New	Purple line

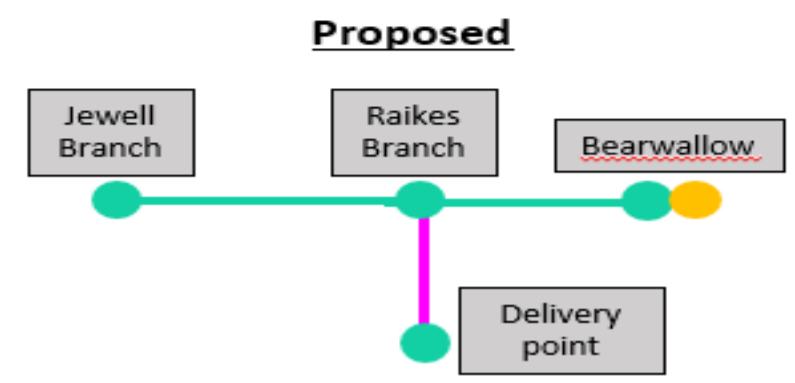

Need Number: AEP-2023-IM022
Process Stage: Submission of Supplemental Project for inclusion in the Local Plan September 4, 2024

Previously Presented:
 Solution Meeting SRRTEP-W - 07/19/2024
 Needs Meeting: 11/17/2023

Supplemental Project Driver: Customer Need

Specific Assumption Reference: AEP Interconnection Guidelines (AEP Assumptions Slide 12)

Model: 2027 RTEP

Problem Statement:
 NEREMC has requested a new delivery point for a peak load of 6MW in Huntertown, Indiana.

Requested ISD: 03/31/2025

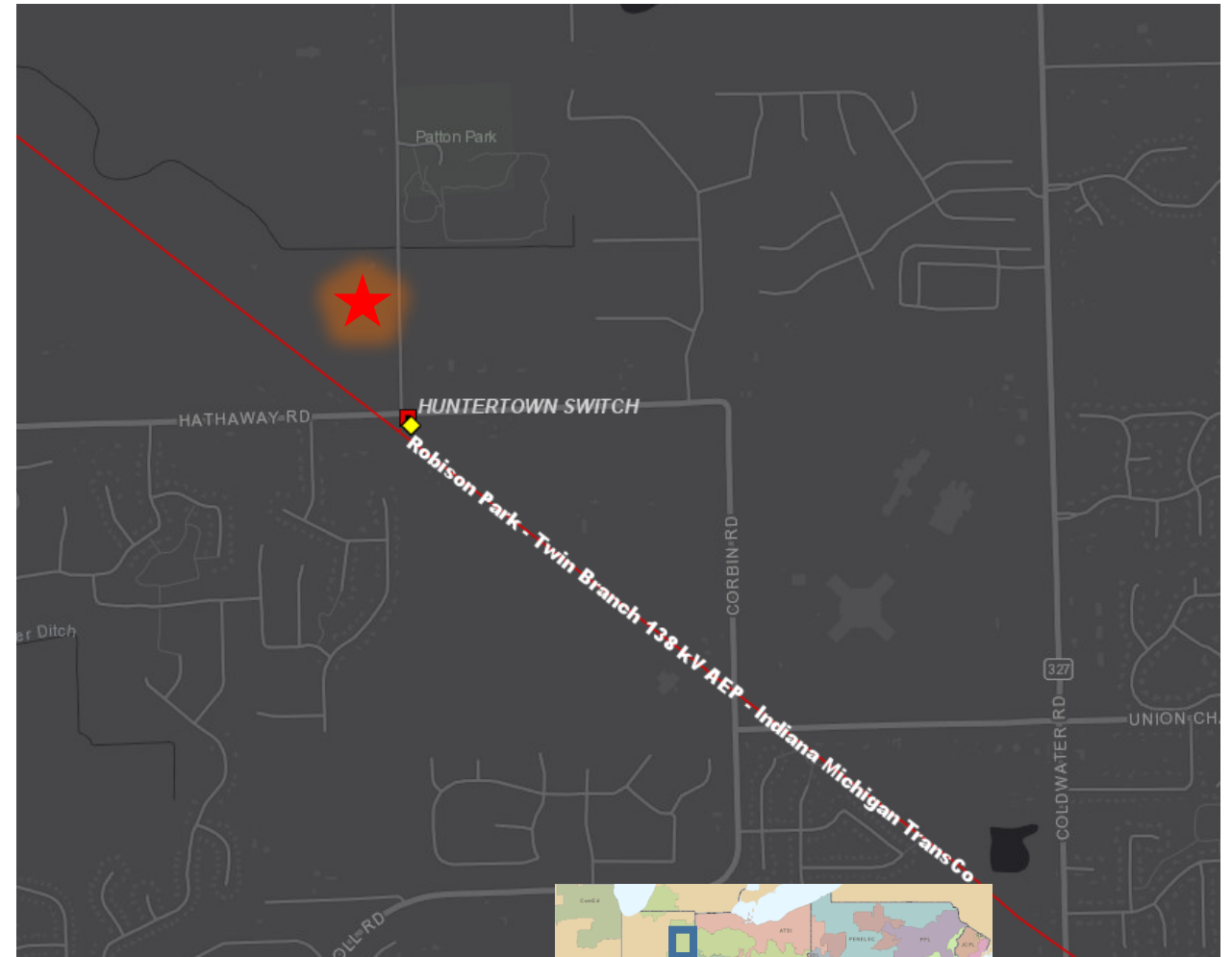

AEP Transmission Zone M-3 Process Hathaway Switch, IN

Need Number: AEP-2023-IM022

Process Stage: Submission of Supplemental Project for inclusion in the Local Plan September 4, 2024

Proposed Solution:

Hathaway Switch Install: Install a 3-way switch, with SCADA, on Albion-Robison Park 138kV circuit. From the new switch, install a ~0.01 mile 138kV line radial to customer station at 138kV. Low-side metering will be installed in the customer owned station. (**\$3389.1**)
Estimated Cost: \$3.2 M

Transmission Cost Estimate: \$3.2 M

Alternatives Considered: There are several interconnections on this 138kV double circuit. An alternate to this project, and related Hatch Project (AEP-2023-IM024), would be to combine these requests and install a station with breakers, or automatic sectionalizing switches, to serve both delivery points. For this alternate, the outage history, total load lost for an outage, and miles of line exposure were considered. Due to the smaller load sizes, and the outage performance of the line, it was determined that the push button switches would be sufficient for both customer requests. Both customer requests are ~3 miles of 138kV apart. It is more cost effective to handle these requests separately, than to install greenfield lines to combine them together. Estimated cost: \$15M

Projected In-Service: 06/19/2025

Project Status: Scoping

Supplemental Project ID: s3389.1

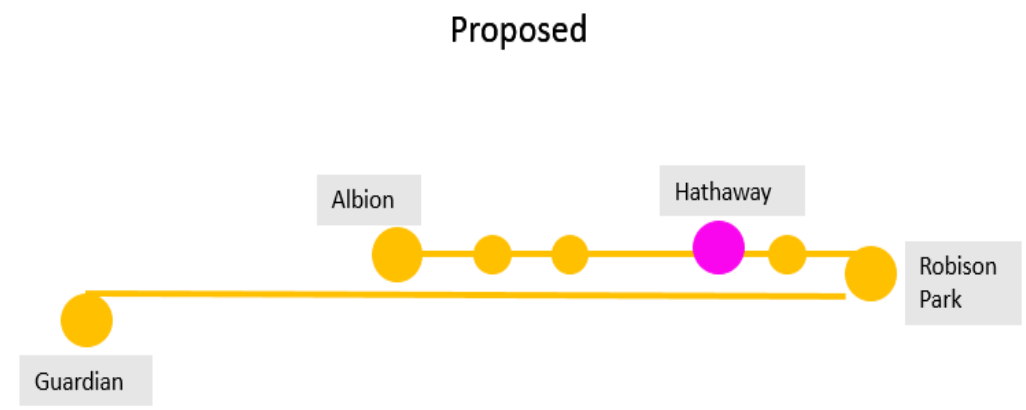

Legend	
500 kV	
345 kV	
138 kV	
69 kV	
34.5 kV	
23 kV	
New	

Need Number: AEP-2023-IM024
Process Stage: Submission of Supplemental Project for inclusion in the Local Plan September 4, 2024

Previously Presented:
 Solution Meeting SRRTEP-W - 07/19/2024
 Needs Meeting: 11/17/2023

Supplemental Project Driver: Customer Need
Specific Assumption Reference: AEP Interconnection Guidelines (AEP Assumptions Slide 12)
Model: 2027 RTEP

Problem Statement:
 NEREMC has requested a new delivery point for a peak load of 6MW in Huntertown, Indiana.

Requested ISD: 03/31/2027

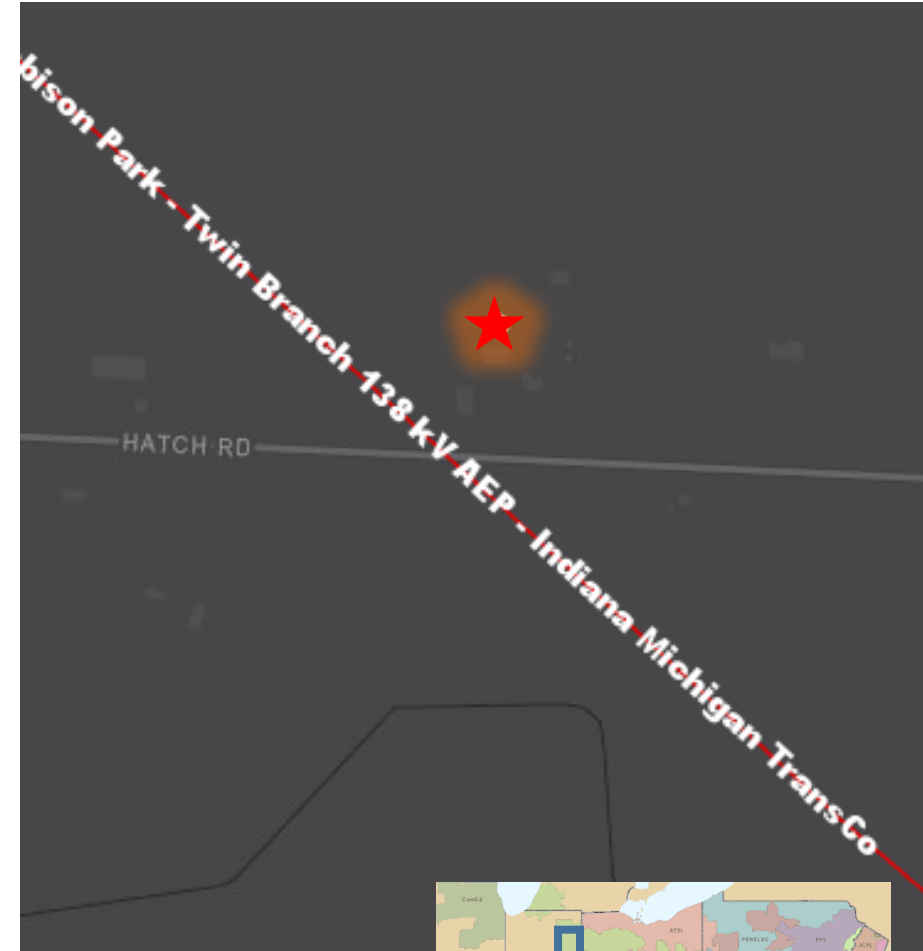

- Circuit Centerline
- 7
 - 12
 - 14
 - 23
 - 34
 - 40
 - 46
 - 69
 - 88
 - 115
 - 138
 - 161
 - 230
 - 345
 - 500
 - 765

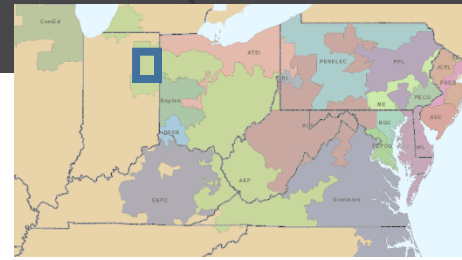

Need Number: AEP-2023-IM024
Process Stage: Submission of Supplemental Project for inclusion in the Local Plan September 4, 2024

Proposed Solution:

Hatch 138 kV Switch Install: Install a 3-way switch, with SCADA, on Albion- Robison Park 138kV circuit. From the new switch install a ~0.2 mile 138kV line radial to customer delivery 138kV. Low-side metering will be installed in the customer owned station. (S3390.1) Estimated Cost: \$4.5 M

Transmission Cost Estimate: \$4.5 M

Alternatives Considered: There are several interconnections on this 138kV double circuit. An alternate to this project, and related Hathaway Project (AEP-2024-IM022), would be to combine these requests and install a station with breakers, or automatic sectionalizing switches, to serve both delivery points. For this alternate, the outage history, total load lost for an outage, and miles of line exposure were considered. Due to the smaller load sizes, and the outage performance of the line, it was determined that the push button switches would be sufficient for both customer requests. Both customer requests are ~3 miles apart. It is more cost effective to handle these requests separately, than to install greenfield lines to combine them together. Estimated Cost: \$15M

Projected In-Service: 03/31/2027

Project Status: Scoping

Supplemental Project ID: s3390.1

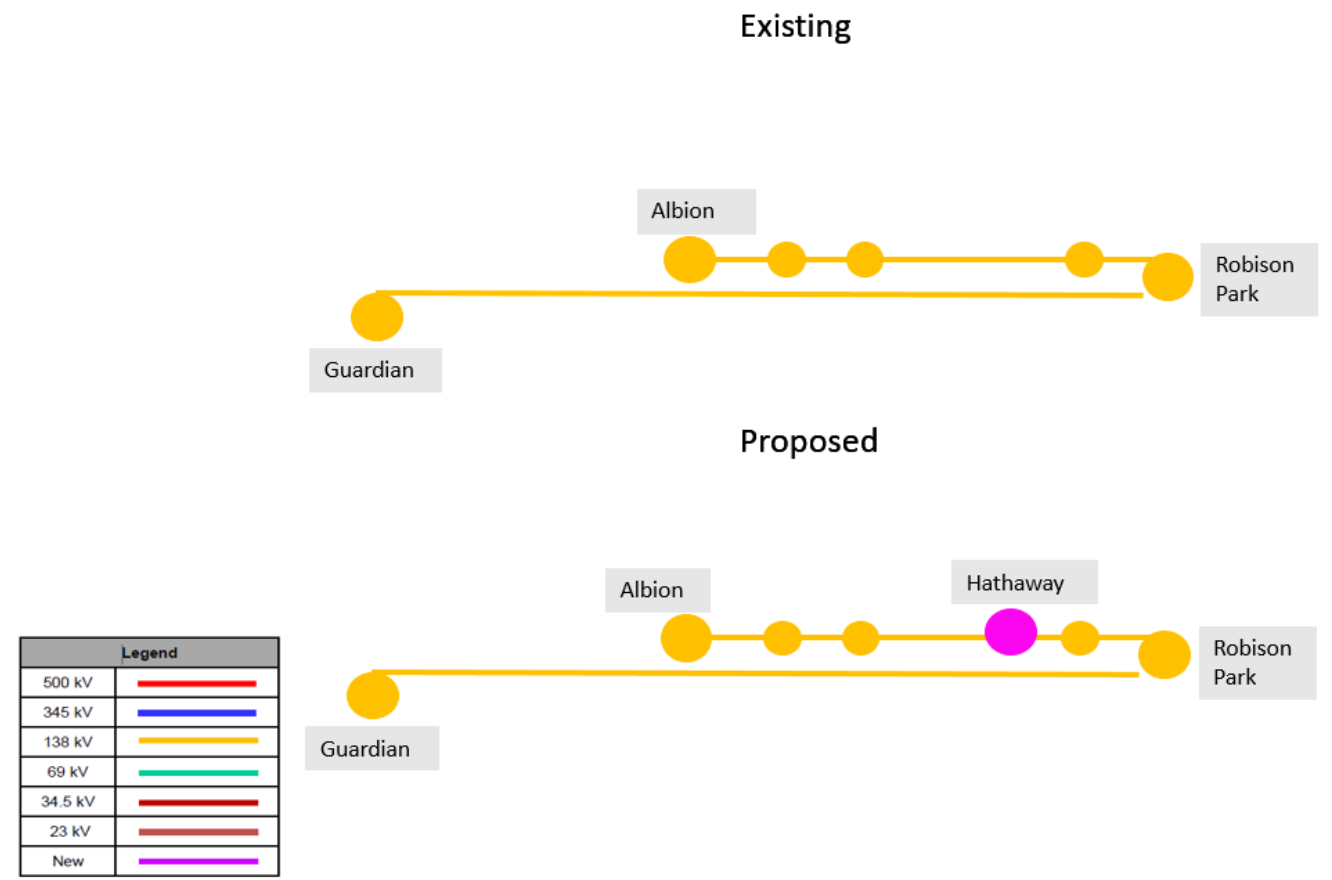

Need Number: AEP-2022-OH071

Process Stage: Submission of Supplemental Project for inclusion in the Local Plan TBD

Previously Presented:

Solution Meeting 5/9/2023, 12/5/2023

Need Meeting 10/14/2022

Project Driver: Customer Service

Specific Assumption Reference:

AEP Guidelines for Transmission Owner Identified Needs (AEP Assumptions Slide 13)

Problem Statement:

- A customer has requested additional 138 kV deliveries to their site in Columbus, Ohio near AEP's proposed Cyprus station (s2526).
- The initial peak demand at these new delivery points will be approximately 200 MW and the ultimate capacity of the customer will be up to 675 MW at the site.



Need Number: AEP-2022-OH071

Process Stage: Submission of Supplemental Project for inclusion in the Local Plan TBD

Solution:

The following work is all direct connect facilities to physically connect demand to the grid.

- **Cyprus 345/138 kV:** Cyprus is the station that was originally developed (s2526) to serve 675 MW of demand with room for 345 kV expansion based on LOA with the customer. Cut into the Beatty – Bixby 345 kV circuit and construct ~1.6 miles of double circuit line, utilizing 2-bundled ACSR Bittern 1272 conductor, SE rating 2278 MVA, to a new 345 kV ring bus at Cyprus station with (4) 5000 A, 63kA circuit breakers, (2) 345/138/34.5 kV, 675 MVA transformers, (12) 4000 A, 63kA, 138 kV circuit breakers, (1) 69.1 MVAR 138 kV Cap bank. Construct (2) 138 kV single circuit, ~0.4 miles, & (2) double circuit, ~0.9 miles, tie lines to the customers dead end structures utilizing ACSR Drake 795 (26/7) conductor SE 360 MVA. Modify the existing Cyprus 138kV Extension & Parsons 138kV circuits #1 & 2 structures to accommodate a fence relocation. Remote end relay upgrades are required at Beatty & Bixby 345 kV stations. Cost: **\$46.9 M (s3440.1)**
- **Parsons 138 kV:** Install (1) 69.1 MVAR cap bank to resolve N-1-1 voltage issues. Cost: **\$2.0 M (s3440.2)**



Existing:

Legend	
765 kV	
345 kV	
138 kV	
69 kV	
34.5 kV	
23 kV	
New	

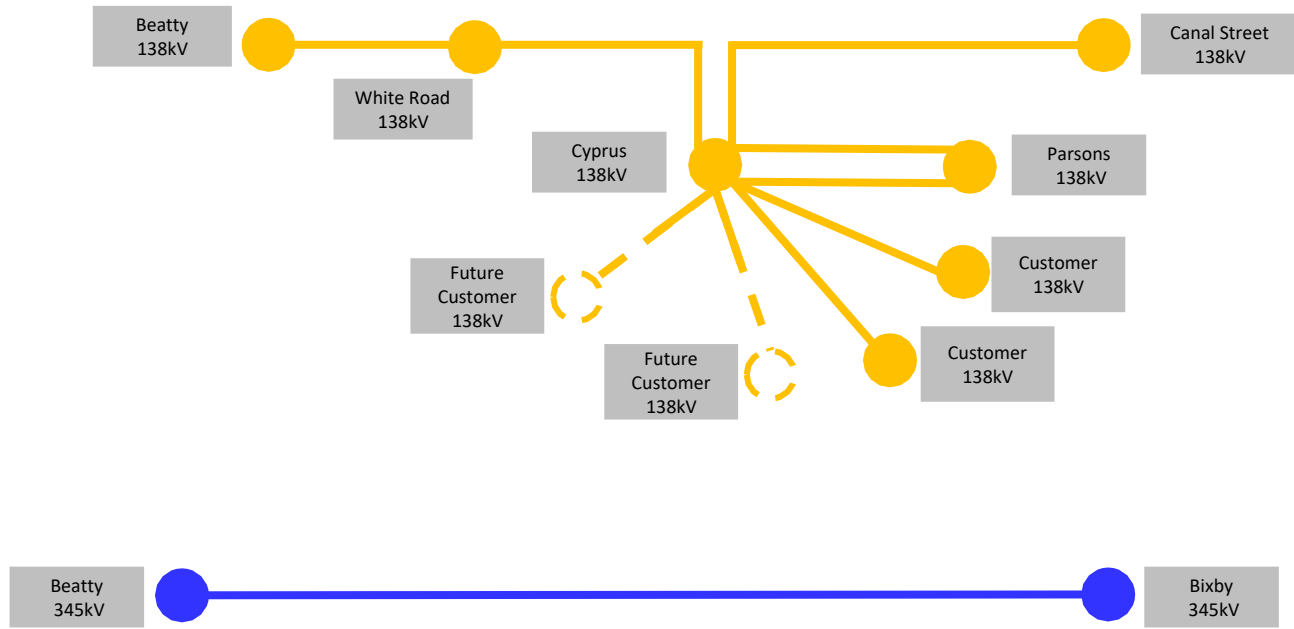

Proposed:

Legend	
765 kV	
345 kV	
138 kV	
69 kV	
34.5 kV	
23 kV	
New	

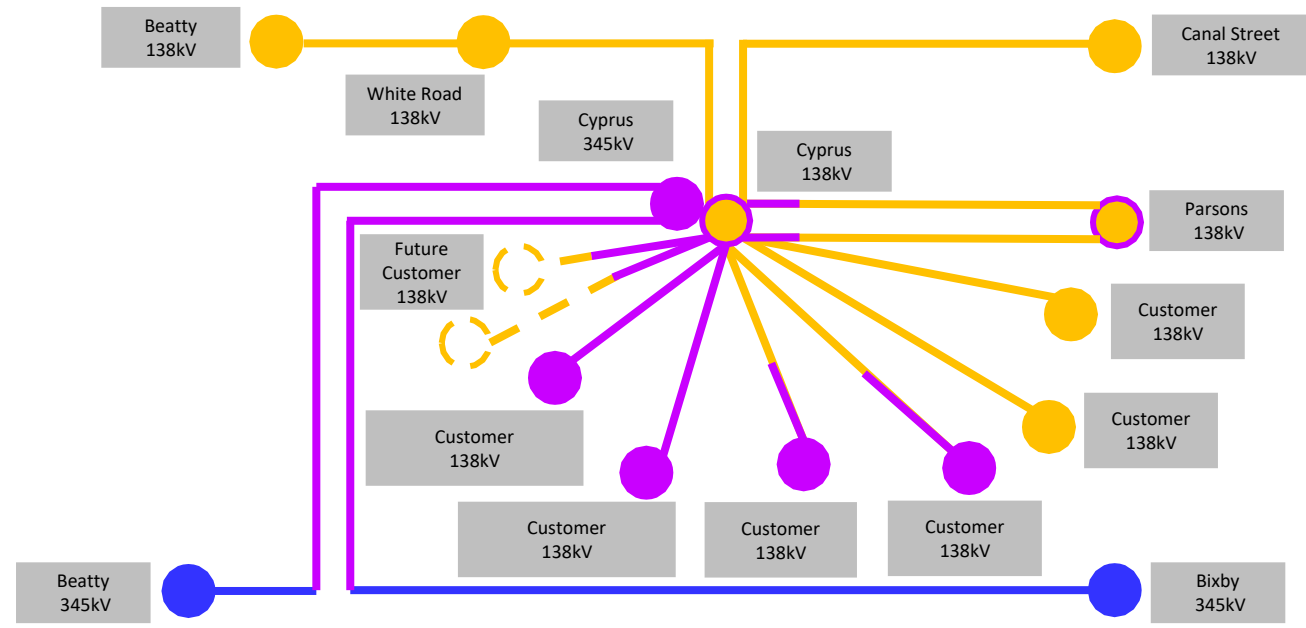



BOUNDLESS ENERGY™

AEP Transmission Zone M-3 Process South Columbus, OH

Need Number: AEP-2022-OH071

Process Stage: Submission of Supplemental Project for inclusion in the Local Plan TBD

Solution:

The following components are system reinforcements required to serve the load and meet applicable TPL-001, PJM, and AEP planning criteria:

- **Beatty – Canal 138 kV line Sag Re-rate:** The Beatty – Canal 138 kV line flagged as overloading under N-1-1 scenarios after the addition of the new load at Cyprus. The line will be flown to address sag issues that are limiting its current rating. It is anticipated that several structures will need to be replaced in order to raise the rating of the line. Cost: **\$5.5 M (s3440.3)**
- **Waverly Reactor 138 kV:** Install a 4% series reactor towards Rozelle at Waverly station to address a N-1-0 scenario related to the loss of a nearby 345 kV line. Cost: **\$3.0 M (s3440.4)**
- **Saint Clair Avenue Reactor 138 kV:** Adjust tap settings on reactors towards Mound and Clinton stations to 3%. Cost: **\$0.0 M (s3440.5)**
- **Marion Station:** Replace switch and line riser at Marion station towards Obetz to address loading concern under certain N-1-1 scenario related to customer interconnections in the area. **\$0.1M (s3440.6)**

System Upgrades: \$8.6M

Direct Connect Facilities: \$48.9M

Total Estimated Transmission Cost: \$57.5M

Projected In-Service: 06/05/2027

Supplemental Project ID: s3440.1-.6

Project Status: Scoping

Need Number: AEP-2021-OH049

Process Stage: Submission of Supplemental Project for inclusion in the Local Plan TBD

Previously Presented:

Solution Meeting 5/9/2023, 12/5/2023

Needs Meeting 7/16/2021, 9/17/2021 & 2/17/2023

Project Driver: Customer Service

Specific Assumption Reference: AEP Connection Requirements for the AEP Transmission System (AEP Assumptions Slide 12)

Problem Statement:

Jerome Delivery Point (AEP) 138 kV:

- A customer has requested new transmission service in Plain City, Ohio.
- The delivery point will be used to serve a customer with high potential for rapid load growth. The initial load will be 106 MW with a potential future peak load demand of 203 MW.
- Service is requested by June 2024.
- The customer communicated a much more aggressive load ramp/build out schedule that would put their peak load at approximately 160 MW by early 2025 at the site.
- This Need was originally presented as a Buckeye Power request; The customer has since requested service from AEP Ohio at the site. As part of this request, the customer has indicated the need for additional feeds at the delivery which will bring the load amount up to 203 MW.

AEP Transmission Zone M-3 Process Jerome

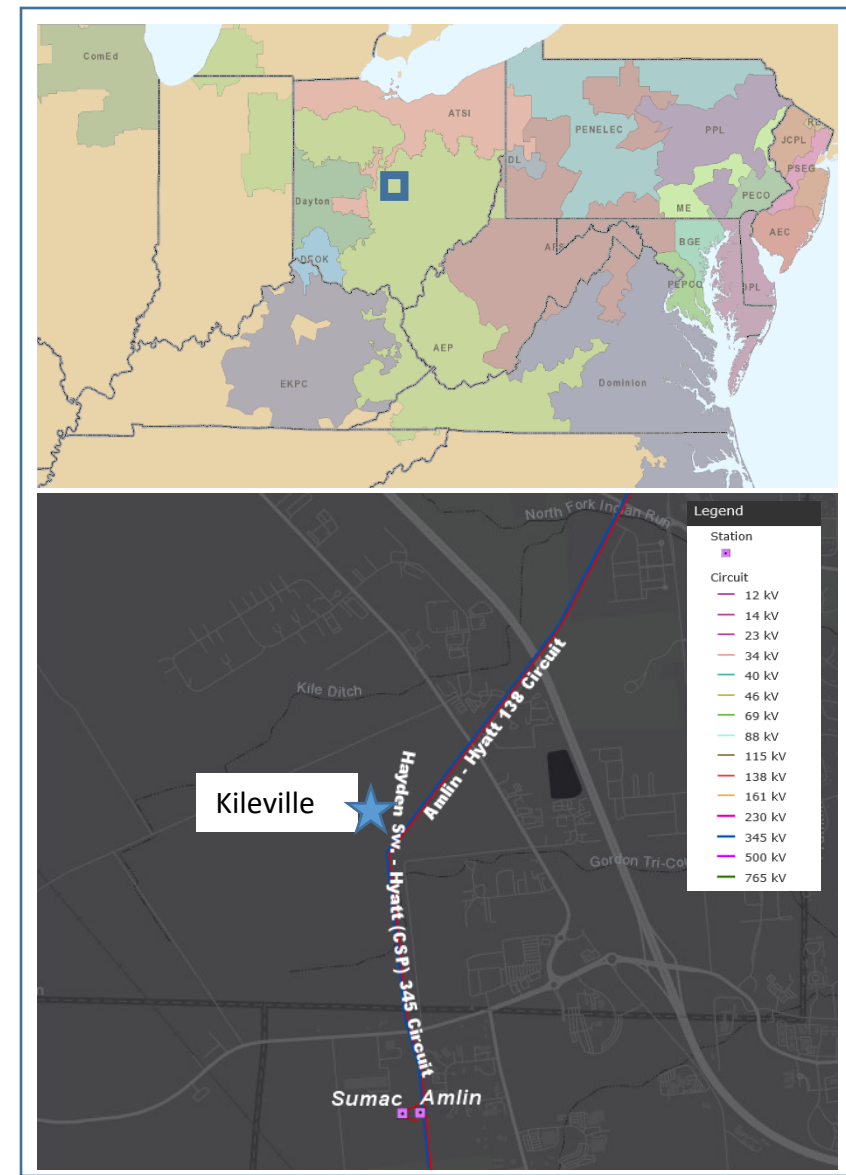

Need Number: AEP-2021-OH049

Process Stage: Submission of Supplemental Project for inclusion in the Local Plan TBD

Solution:

The following scope of work is all direct connect facilities to physically connect demand to the grid.

- **Jerome 138 kV:** Construct a greenfield Jerome station with (11) 138kV 63kA 4000A circuit breakers in breaker and half bus configuration. Construct ~ 2.5 miles of double circuit 138kV transmission line extending from Celtic & Kileville stations utilizing 2-bundled ACSS Cardinal 954 (45/7) conductor, SE rating 1061 MVA. Construct ~1.6 miles of double circuit 138kV transmission line extending from Jerome to cut-in back to Hyatt – Amlin line utilizing 2-bundled ACSS Cardinal 954 (45/7) conductor, SE rating 1061 MVA. Construct (4) 138 kV tie lines to the customers dead end structures ~0.05 miles utilizing ACSR Dove 556.5 (26/7) conductor SE 284 MVA. Customers will be directly connected at this station. Cost: **\$30 M (s3441.1)**

Need Number: AEP-2022-OH024

Process Stage: Submission of Supplemental Project for inclusion in the Local Plan TBD

Previously Presented:

Solutions Meeting 5/9/2023, 12/5/2023

Need Meeting 2/18/2022

Project Driver: Customer Service

Specific Assumption Reference:

AEP Connection Requirements for the AEP Transmission System (AEP Assumptions Slide 12)

Problem Statement:

Customer Service:

- A customer has requested transmission service at a site North of AEP's existing Roberts station in Columbus, OH.
- The customer has indicated an initial peak demand of 125 MW with an ultimate capacity of up to 328 MW at the site.
- Initial customer requested in-service date of June 1, 2024.

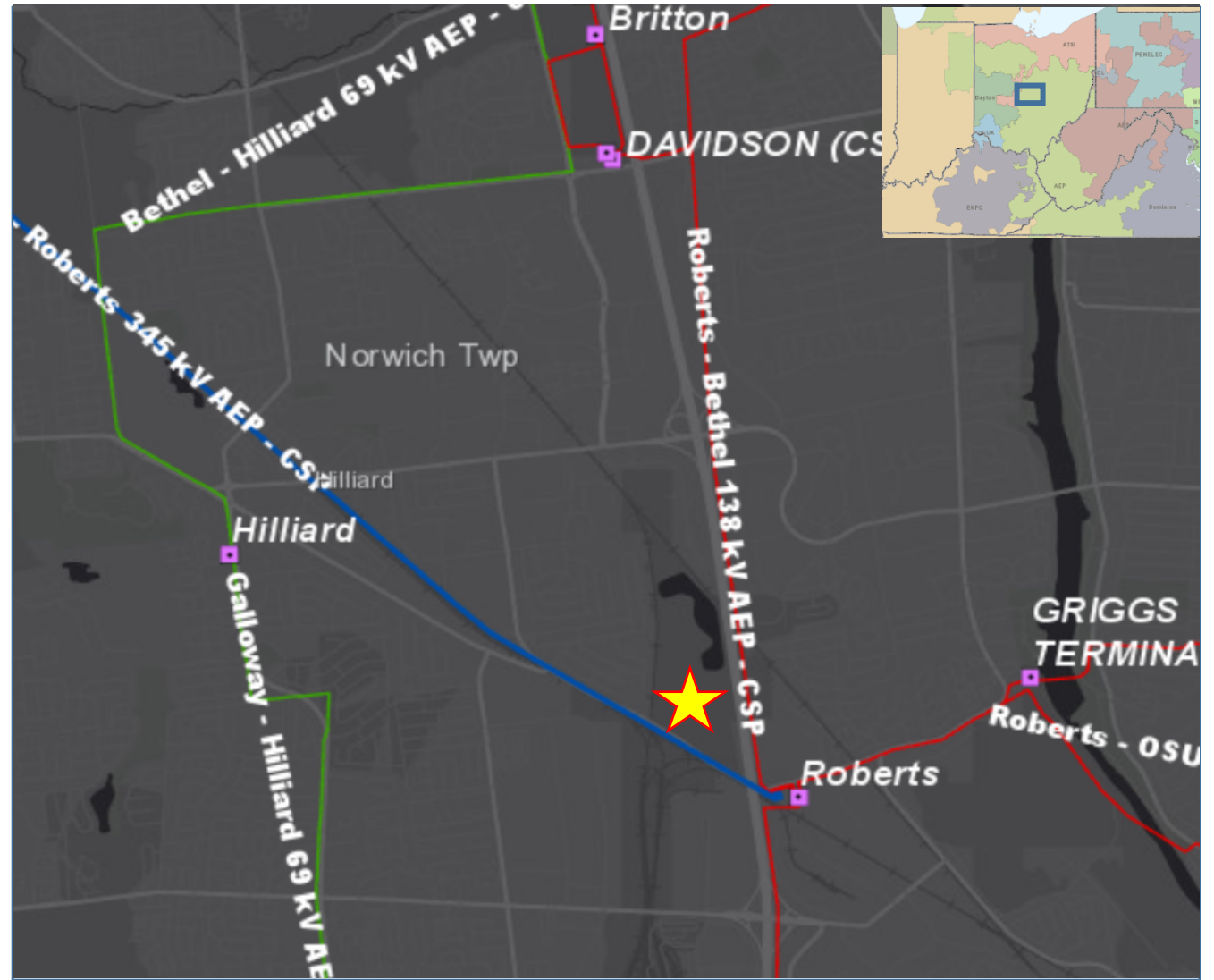

Need Number: AEP-2022-OH024

Process Stage: Submission of Supplemental Project for inclusion in the Local Plan TBD

Solution:

The following scope of work is all direct connect facilities to physically connect demand to the grid.

- **Beacon 345 kV:** Construct a greenfield station with (8) 5000 A, 345 kV, 63 kA circuit breakers & (1) 158.4 MVAR 345 kV Cap bank in a breaker and a half configuration. Cut into the 345 kV Hayden – Roberts No. 2 circuit with two single circuit 345 kV lines ~0.2 miles terminating into Beacon station; utilizing 2-bundle ACSR Rail 954 (45/7) conductor SE 1887 MVA. A structure will need be installed to raise the Hayden – Roberts No 1 circuit. Construct three single circuit lines ~0.1 miles, between Beacon and the customer; utilizing 2-bundle ACSR Drake 795 (26/7) conductor SE 1800 MVA. Cost: **\$40.0M (s3441.2)**

Need Number: AEP-2022-OH035

Process Stage: Previously Presented: Submission of Supplemental Project for inclusion in the Local Plan TBD

Solutions Meeting 5/9/2023, 12/5/2023

Need Meeting 4/22/2022

Project Driver: Customer Service

Specific Assumption Reference:

AEP Connection Requirements for the AEP Transmission System (AEP Assumptions Slide 12)

Problem Statement:

Customer Service:

- The customer Served out of Cosgray station (S2653) has requested additional transmission service to their existing site southeast of AEP's existing Hayden station in Hilliard, OH.
- The customer has indicated a peak demand of 218 MW at the site.
- The customer has requested an ISD of 4/1/2024

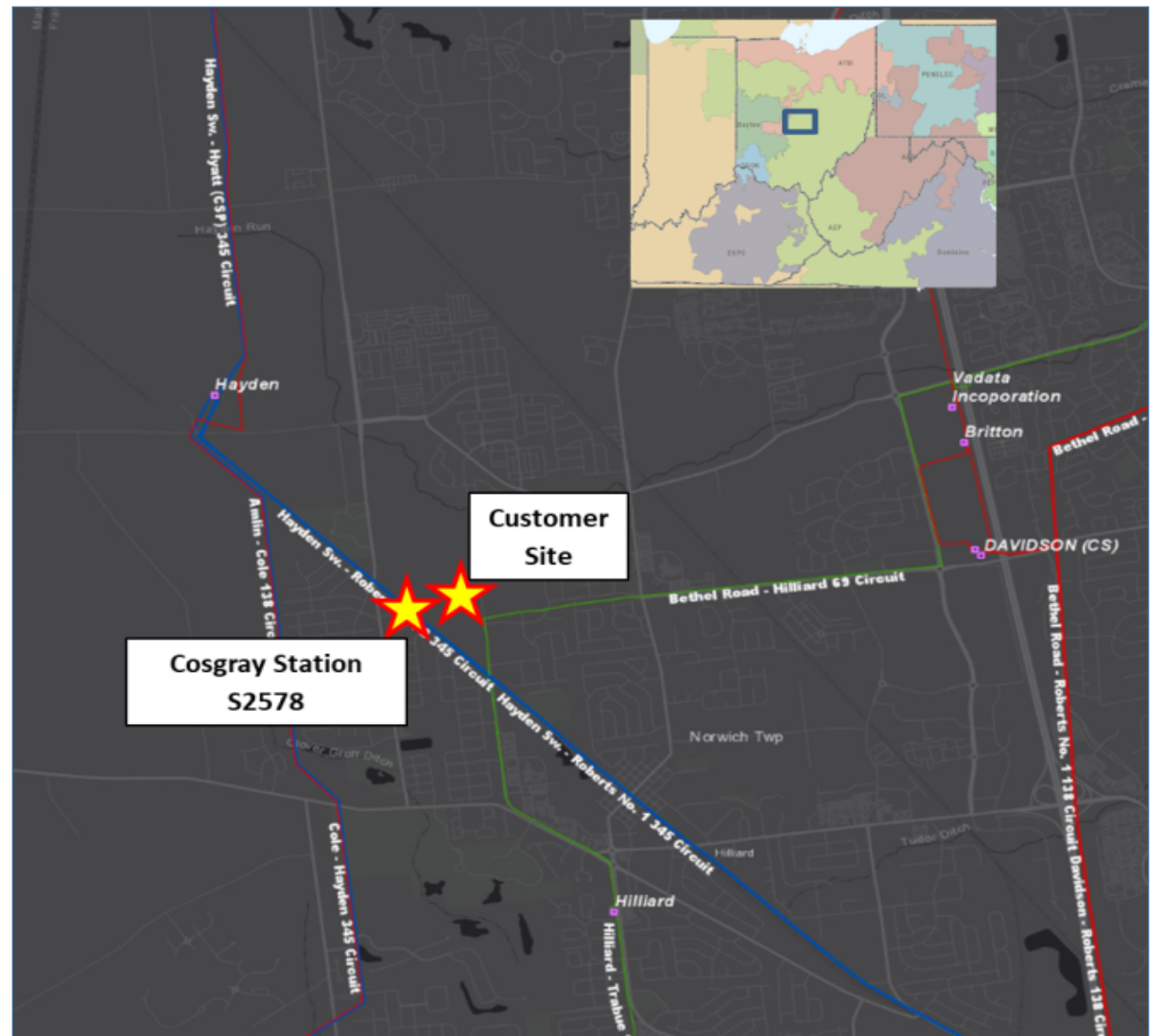

Need Number: AEP-2022-OH035

Process Stage: Submission of Supplemental Project for inclusion in the Local Plan TBD

Solution:

The following scope of work is all direct connect facilities to physically connect demand to the grid.

- **Cosgray 345 kV:** Expand the existing Cosgray ring bus (originally proposed under s2653) station by installing (2) 5000 A, 63 kA, 345 kV circuit breakers. Construct two ~0.06 miles single circuit lines to connect the new customer deliveries to Cosgray. Cost: **\$5.1 M (s3441.3)**

Need Number: AEP-2023-OH041

Process Stage: Previously Presented: Submission of Supplemental Project for inclusion in the Local Plan TBD

Solutions Meeting 5/9/2023, 12/5/2023

Needs Meeting 2/17/2023

Project Driver: Customer Service

Specific Assumption Reference:

AEP Connection Requirements for the AEP Transmission System (AEP Assumptions Slide 12)

Problem Statement:

Customer Service:

- An existing customer planned to be served out of AEP’s proposed Kileville Station in Union Count, OH, has requested service for an incremental bulk load addition of 96 MW. This will bring the total & ultimate load for the customers site to 258 MW.
- Customer requested in-service date of 4/1/2024.

AEP Transmission Zone M-3 Process Kileville

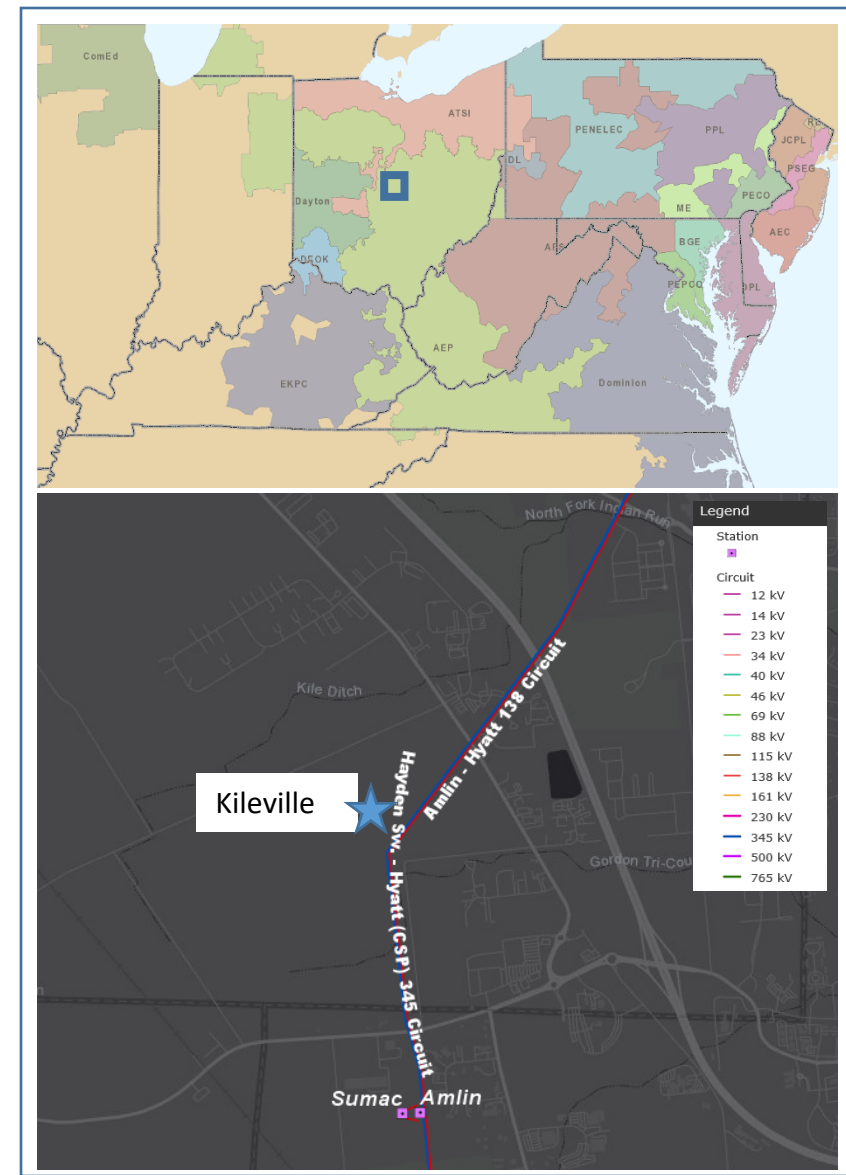

Need Number: AEP-2023-OH041

Process Stage: Submission of Supplemental Project for inclusion in the Local Plan TBD

Solution:

The following scope of work is all direct connect facilities to physically connect demand to the grid.

- **Celtic 345/138 kV:** Originally, Kileville is the station that was envisioned (s2855) to serve 461 MW of demand with room for 345 kV expansion based on LOAs with the customer. However, land in the area of the proposed Kileville station was not available for expansion to install 345/138 kV transformation. Therefore, a new station site called Celtic is being proposed to serve as the 345 kV source for the 461 MW of load to be served in this area. Cut into the Hayden – Hyatt 345 kV circuit, reroute ~0.8 miles of the circuit and extend ~1.1 miles of new double circuit line, utilizing 2-bundled ACSR Pheasant 1272 (54/19) conductor, SE rating 2413 MVA, to the greenfield Celtic 345/138 kV station with (4) 345 kV, 63 kA, 5000 A breakers laid out as ring bus configuration on high side. Install two 675MVA-345/138 kV power transformers. Install (6) 138kV, 63 kA, 4000 A breakers & (2) 69.1 MVAR 138 kV Cap bank on low side configured as ring bus with provisions for future breaker and half configuration. The proposed Kileville – Jerome 138 kV circuit will be brought in and out of the station. Cost: **\$60 M (s3441.4)**
- **Kileville 138 kV:** Expand Kileville station (originally proposed under s2855) with (4) additional 63 kA, 4000A circuit breakers in breaker and half bus configuration. Construct (2) 138 kV tie lines to the customers dead end structures ~0.05 miles utilizing ACSR Dove 556.5 (26/7) conductor SE 284 MVA. Customers will be directly connected at this station. Cost: **\$4.1 M (s3441.5)**

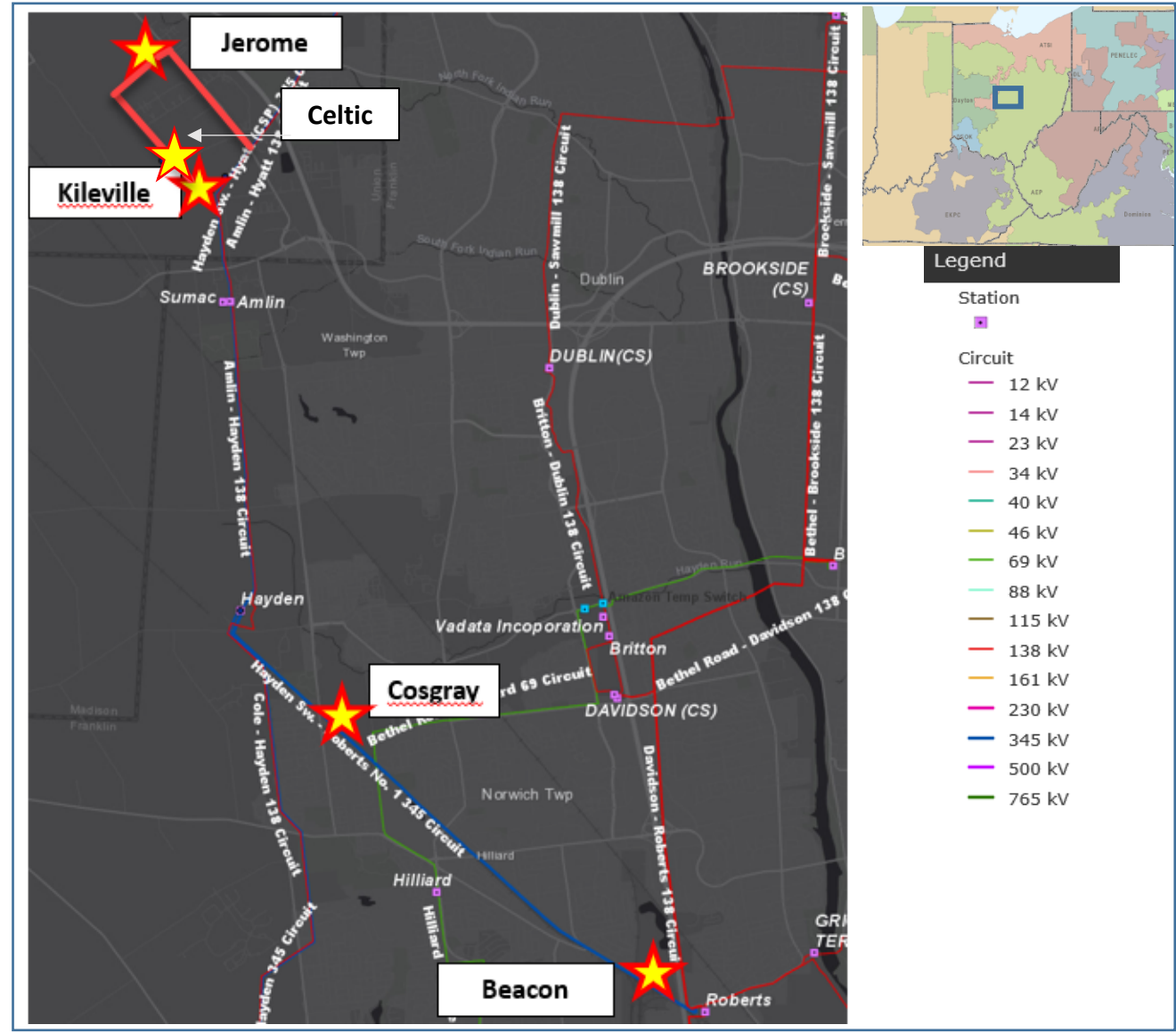

Existing:

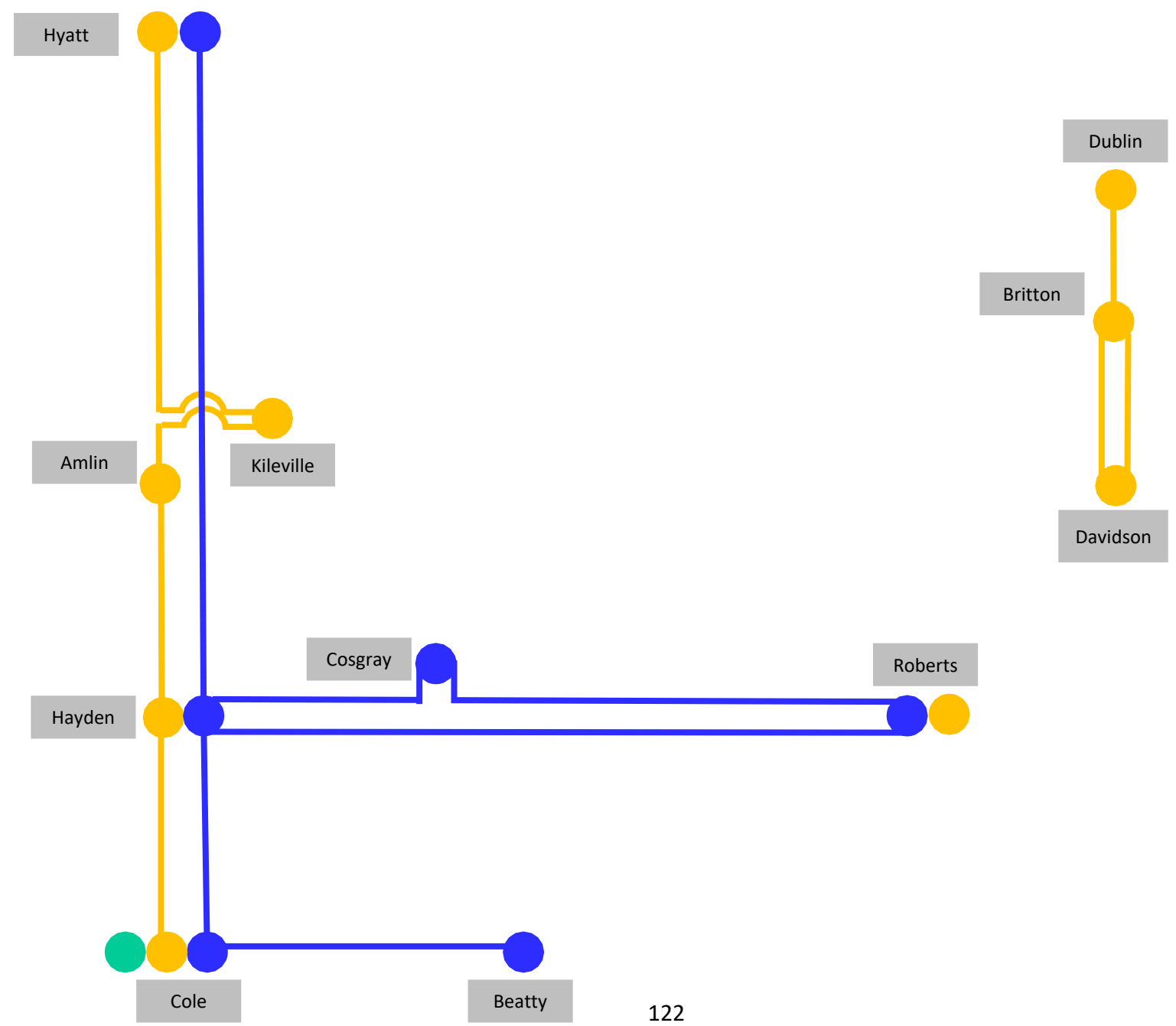

Legend	
765 kV	
345 kV	
138 kV	
69 kV	
34.5 kV	
23 kV	
New	

Existing:

Proposed:

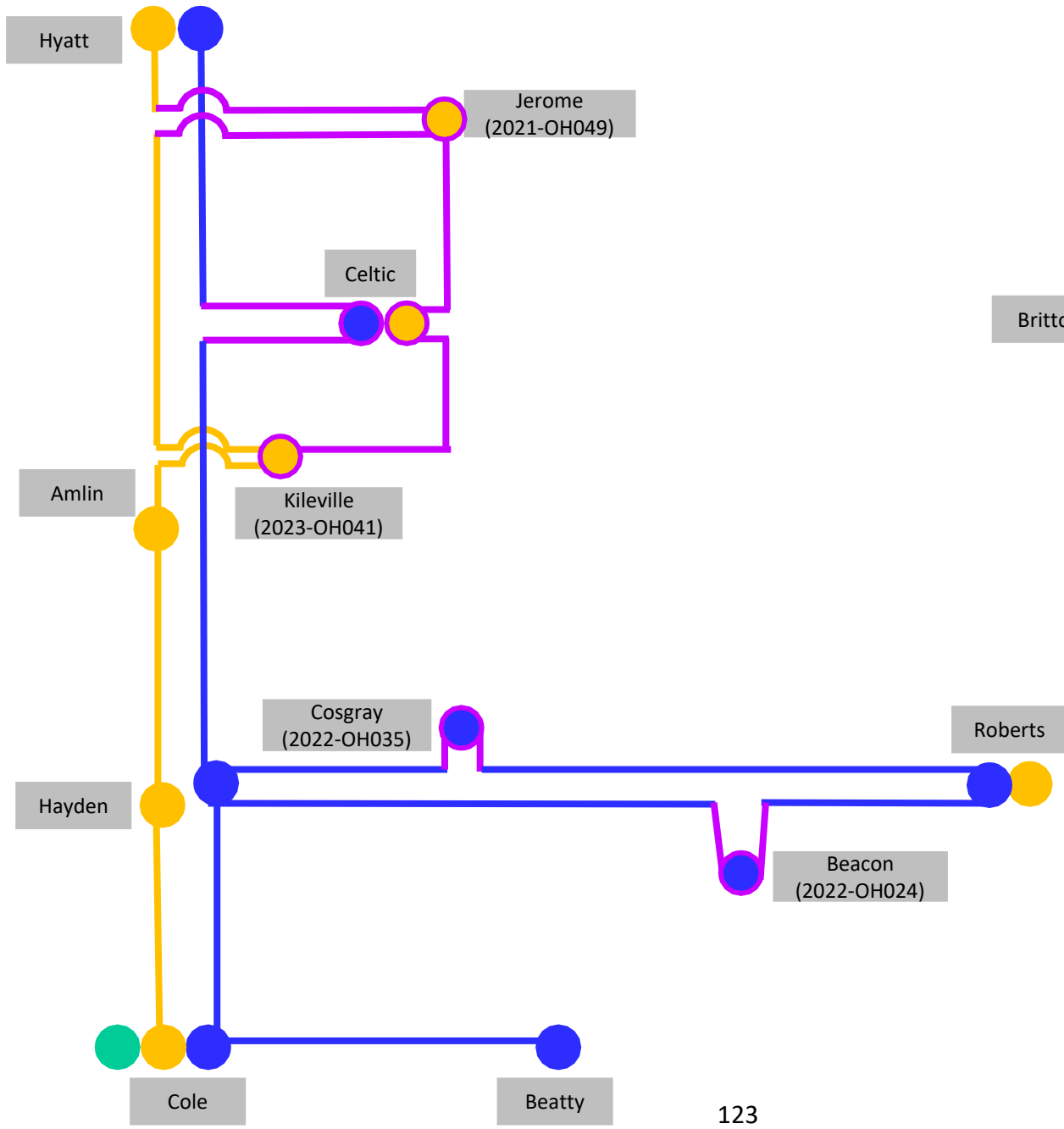

Legend	
765 kV	—
345 kV	—
138 kV	—
69 kV	—
34.5 kV	—
23 kV	—
New	—

Proposed:

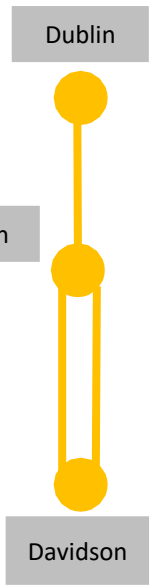



AEP Transmission Zone M-3 Process Dublin & Hilliard, OH

Need Number: AEP-2021-OH049, AEP-2022-OH024, AEP-2022-OH035, AEP-2023-OH041

Process Stage: Submission of Supplemental Project for inclusion in the Local Plan TBD

Solution:

The following components are system reinforcements required to serve the load and meet applicable TPL-001, PJM, and AEP planning criteria:

- **Beatty – Wilson 138 kV line Sag Re-rate:** Due to new customer interconnections in the area the Beatty – Wilson, Beatty – Bolton, Bolton – Hall and Hall - Wilson 138 kV circuits will overload for certain N-1-1 scenarios. Structures will be replaced on the line to address distribution clearance issue in order to allow the lines to operate to their conductor’s designed maximum operating temperature. Cost: **\$1.5 M (s3441.6)**
- **Dublin Reactor 138 kV:** Install a 4% series reactor towards Sawmill at Dublin station to address a N-1-1 scenario as a result of the new load interconnections in the area. Cost: **\$3.0 M (s3441.7)**

System Upgrades: \$4.5M

Direct Connect Facilities: \$139.2M

Total Estimated Transmission Cost: \$143.7M

Projected In-Service: 12/01/2026

Supplemental Project ID: s3441.1-.7

Project Status: Scoping

Need Number: AEP-2022-OH023

Process Stage: Submission of Supplemental Project for inclusion in the Local Plan TBD

Previously Presented:

Solutions Meeting 5/9/2023, 12/5/2023

Need Meeting 2/18/2022

Project Driver: Customer Service

Specific Assumption Reference:

AEP Connection Requirements for the AEP Transmission System (AEP Assumptions Slide 12)

Problem Statement:

Customer Service:

- A customer has requested transmission service at a site North of AEP's existing Jugg Street station in Columbus, OH.
- The customer has indicated an initial peak demand of 125 MW with an ultimate capacity of up to 290 MW at the site.
- Initial customer requested in-service date of June 1, 2024.

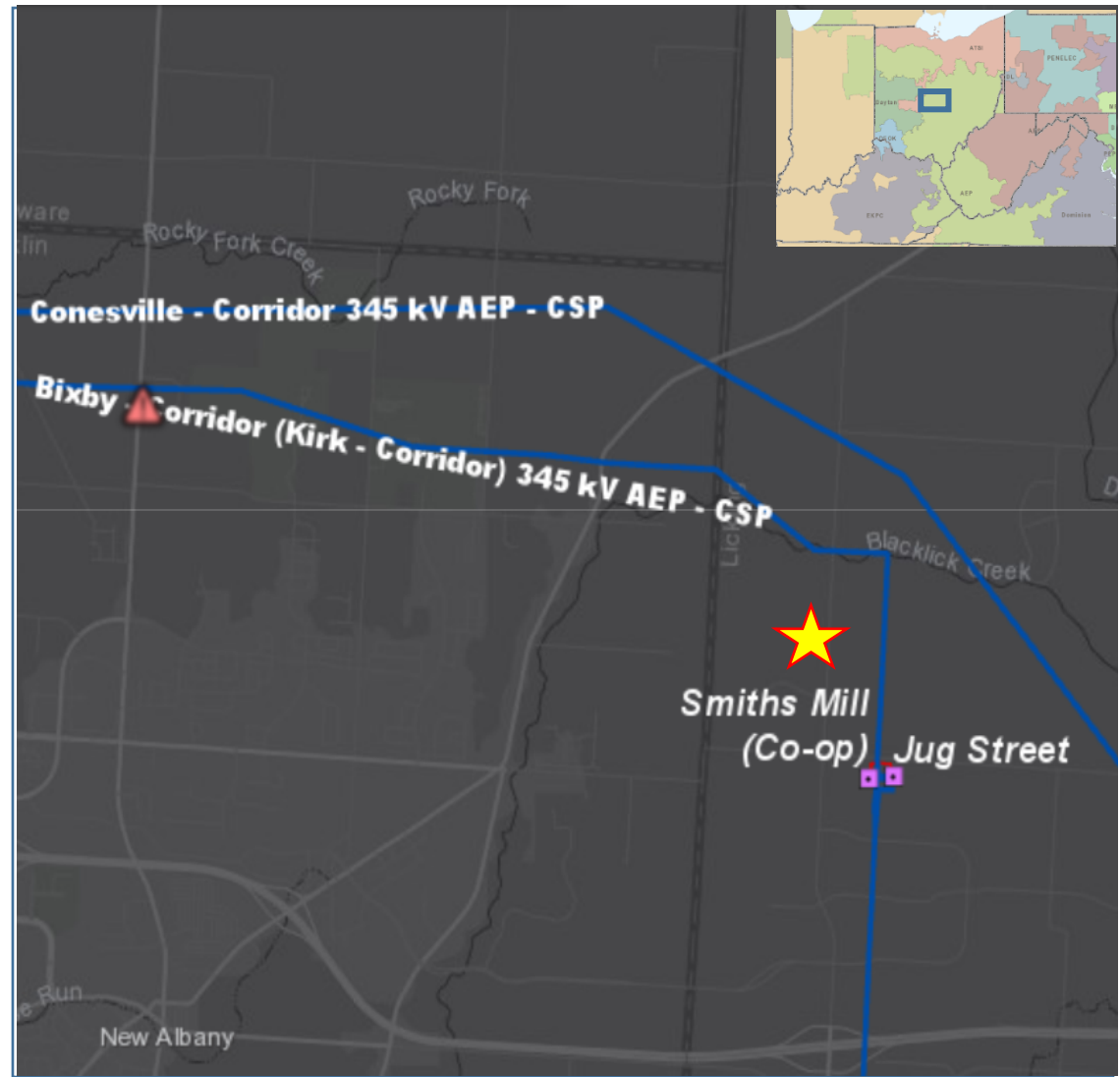

Need Number: AEP-2022-OH023

Process Stage: Submission of Supplemental Project for inclusion in the Local Plan TBD

Solution:

The following work is all direct connect substation to physically connect demand to the grid.

- **Badger 138 kV:** Cut into the Green Chapel – Jug 138 kV circuit and extend ~ 0.1 miles of new double circuit line, utilizing 2-bundled ACSR Falcon 1590 (54/19) conductor, SE rating 1118 MVA, to the greenfield Badger station with (10) 80 kA, 4000 A breakers & (1) 69.1 MVAR 138 kV Cap bank, laid out as breaker and a half for future expansion to 6 strings. Construct 4 - 138 kV tie lines to the customers dead end structures ~.05 miles utilizing ACSR Dove 556.5 (26/7) conductor SE 284 MVA. Cost: **\$18.43 M (s3442.1)**

Need Number: AEP-2022-OH034

Process Stage: Submission of Supplemental Project for inclusion in the Local Plan TBD

Previously Presented:

Solutions Meeting 5/9/2023, 12/5/2023

Need Meeting 4/22/2022

Project Driver: Customer Service

Specific Assumption Reference:

AEP Connection Requirements for the AEP Transmission System (AEP Assumptions Slide 12)

Problem Statement:

Customer Service:

- A customer has requested transmission service at a site East of AEP's existing Anguin station in New Albany, OH.
- The customer has indicated a peak demand of 216 MW at the site.
- The customer has requested an ISD of 5/31/2023

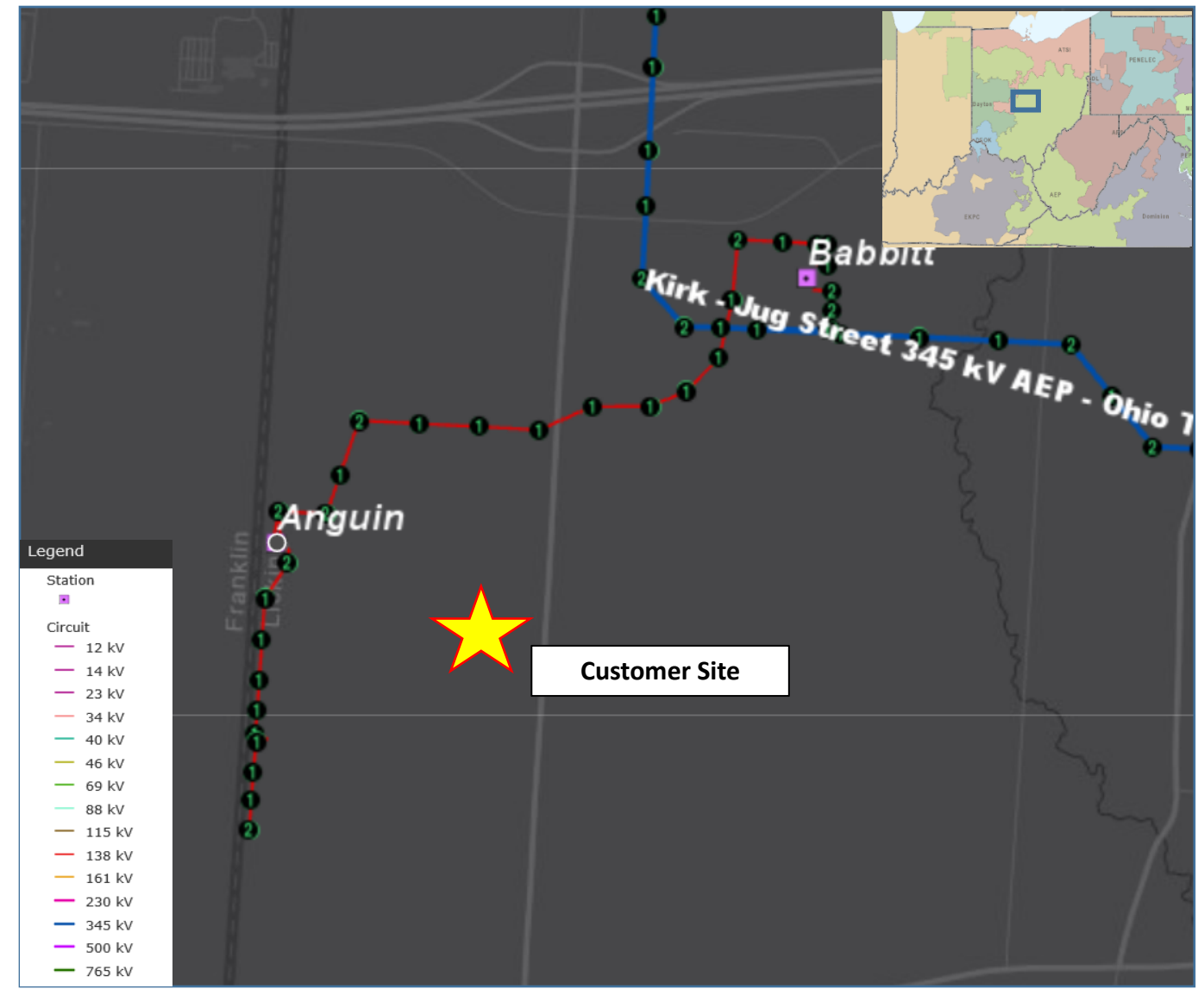

Need Number: AEP-2022-OH034

Process Stage: Submission of Supplemental Project for inclusion in the Local Plan TBD

Solution:

The following work is all direct connect substations to physically connect demand to the grid.

- **QTS North 138 kV:** Construct ~0.3 miles of double circuit & a single circuit radial 138 kV tie lines from Anguin station to QTS Customer's site dead-end structures serving transformers #1, #2 # 3, each utilizing ACSR Dove 556.5 (26/7) conductor SE 284 MVA. Cost: **\$1.8 M (s3442.2)**

Need Number: AEP-2022-OH036

Process Stage: Submission of Supplemental Project for inclusion in the Local Plan TBD

Previously Presented:

Solutions Meeting 5/9/2023, 12/5/2023

Need Meeting 04/22/2022

Project Driver: Customer Service

Specific Assumption Reference:

AEP Connection Requirements for the AEP Transmission System (AEP Assumptions Slide 12)

Problem Statement:

Customer Service:

- The customer served out of Innovation station (S2578) has requested additional transmission service at their existing site just south of the existing Conesville – Corridor 345 kV circuit in New Albany, OH.
- The customer has indicated a peak demand of 247 MW at the site.
- The customer has requested an ISD of 4/1/2024



Need Number: AEP-2022-OH036

Process Stage: Submission of Supplemental Project for inclusion in the Local Plan TBD

Solution:

The following work is all direct connect substations to physically connect demand to the grid.

- **Innovation 345/138 kV:** Cut into the Corridor - Conesville 345 kV circuit and construct ~0.1 miles of double circuit line, utilizing 2-bundled ACSR Bittern 1272 conductor, SE rating 2278 MVA, to a new 345 kV ring bus at Innovation station (s2578) with (4) 5000 A, 63kA circuit breakers, (2) 345/138/34.5 kV, 675 MVA transformers, (15) 4000 A, 80, kA, 138 kV circuit breakers, (2) 69.1 MVAR, 138 kV Cap banks. Upgrade the line protection relays at Conesville & Corridor 345 kV. Construct (2) 138 kV tie lines to the customers dead end structures ~0.04 miles utilizing ACSR Dove 556.5 (26/7) conductor SE 284 MVA. Cost: **\$53.7 M (s3442.3)**

Need Number: AEP-2022-OH045

Process Stage: Submission of Supplemental Project for inclusion in the Local Plan TBD

Previously Presented:

Solutions Meeting 5/9/2023, 12/5/2023

Need Meeting 06/15/2022

Project Driver: Customer Service

Specific Assumption Reference:

AEP Connection Requirements for the AEP Transmission System (AEP Assumptions Slide 12)

Problem Statement:

Customer Service:

- A customer has requested distribution service at a site North of AEP's existing Jug Street station in New Albany, OH. In addition, AEP Ohio has requested an additional delivery point from this location.
- The customer has indicated their initial load demand of 50 MW with an ultimate peak demand of 200 MW at the site.
- The customer has requested an ISD of 4/30/2024



Need Number: AEP-2022-OH045

Process Stage: Submission of Supplemental Project for inclusion in the Local Plan TBD

Solution:

The following work is all direct connect substations to physically connect demand to the grid.

- **Horizon 138 kV:** Construct a greenfield station with (8) 80 kA, 4000 A circuit breakers in breaker and half bus configuration. Construct ~ 0.05 miles of double circuit 138kV transmission line extending from the Jug St.- Green Chapel 138 kV circuit to Horizon station utilizing 2-bundled ACSR Falcon 1590 (54/19) conductor, SE rating 1118 MVA. Cost: **\$10.81 M (s3442.4)**

Need Number: AEP-2022-OH046

Process Stage: Submission of Supplemental Project for inclusion in the Local Plan TBD

Previously Presented:

Solutions Meeting 5/9/2023, 12/5/2023

Need Meeting 6/15/2022

Project Driver: Customer Service

Specific Assumption Reference:

AEP Connection Requirements for the AEP Transmission System (AEP Assumptions Slide 12)

Problem Statement:

Customer Service:

- A customer has requested transmission service at a site East of AEP's existing Jug Street station in New Albany, OH.
- The customer has indicated their initial demand of 50 MW with an ultimate peak demand up to 270 MW in the future.
- The customer has requested an ISD of 6/28/2024



Need Number: AEP-2022-OH046

Process Stage: Submission of Supplemental Project for inclusion in the Local Plan TBD

Solution:

The following work is all direct connect substations to physically connect demand to the grid.

- **Jorden 138 kV:** Cut into the Innovation – Kirk 138 kV circuit with two single circuit 138 kV lines ~0.35 miles terminating into Jorden station, utilizing 2-bundled ACSS Curlew 1033.5 (54/7) conductor, SE rating 1123 MVA, to Construct a greenfield 138 kV 4-CB ring bus station, configurable to 4-strings breaker and half station in future, with (4) 4000 A, 80 kA circuit breakers. Construct two single circuit 138kV lines ~0.1 miles, between Jorden and the customer. Cost: **\$12.5 M (s3442.5)**

Need Number: AEP-2022-OH075

Process Stage: Submission of Supplemental Project for inclusion in the Local Plan TBD

Previously Presented:

Solutions Meeting 5/9/2023, 12/5/2023

Needs Meeting 12/6/2022

Project Driver: Customer Service

Specific Assumption Reference:

AEP Connection Requirements for the AEP Transmission System (AEP Assumptions Slide 12)

Problem Statement:

Customer Service:

- A customer has requested transmission service at a site Southeast of AEP's existing Anguin station in New Albany, OH.
- The customer has indicated a peak demand of 125 MW at the site.
- The customer has requested an ISD of 8/1/2024

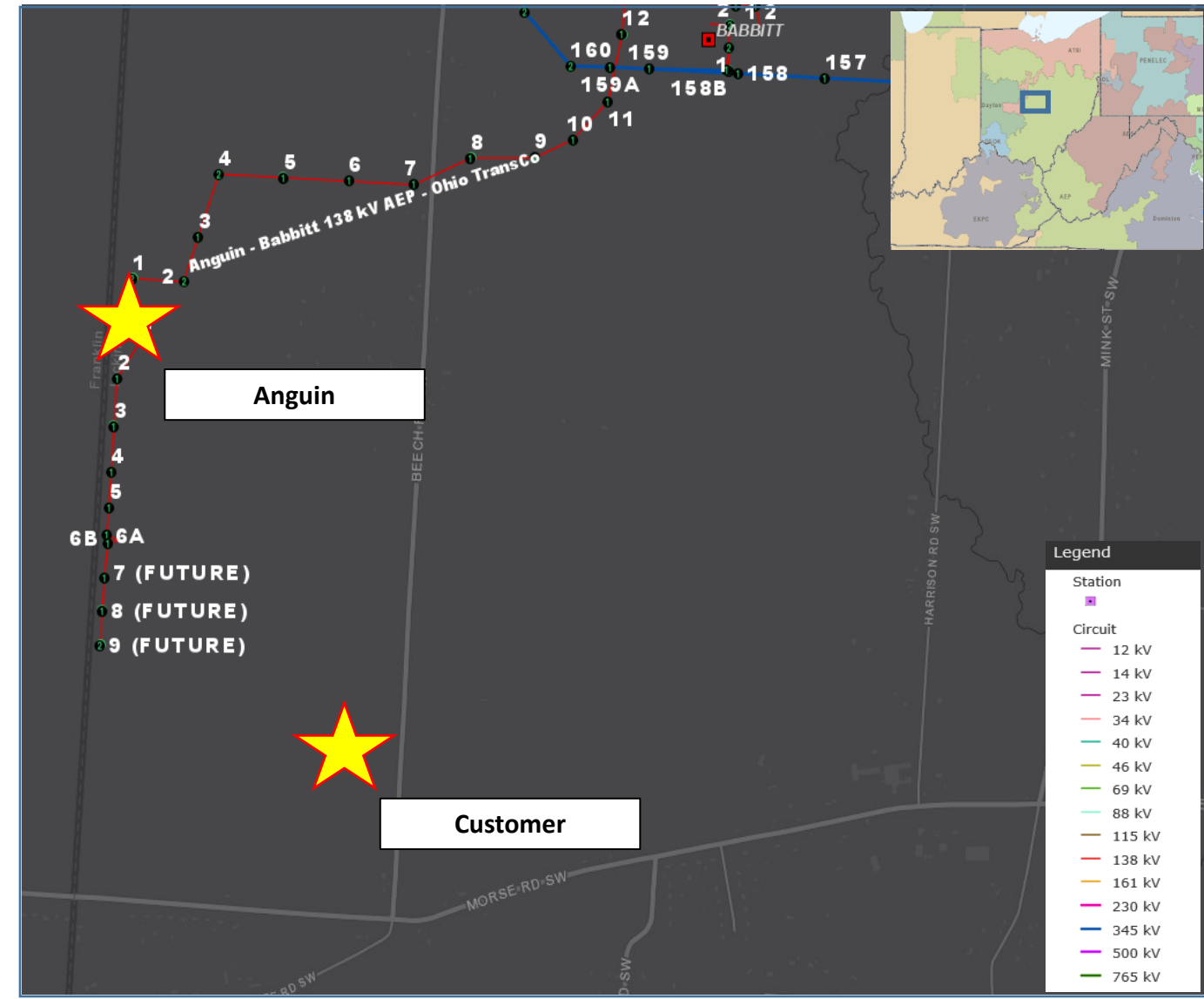

Need Number: AEP-2022-OH075

Process Stage: Submission of Supplemental Project for inclusion in the Local Plan TBD

Solution:

The following work is all direct connect substations to physically connect demand to the grid.

- **QTS South 138 kV:** Cut into one of the circuits of Anguin – Brie 138 kV line and extend ~0.1 miles of two single circuit lines, utilizing 2-bundled ACSS Curlew 1033.5 (54/7) conductor, SE rating 1123 MVA, to the greenfield Macy station with (4) 80 kA, 4000 A breakers laid out as 4-CB ring bus. Construct (2) 138 kV tie lines to the customers dead end structures ~0.04 miles utilizing ACSR Dove 556.5 (26/7) conductor SE 284 MVA. Cost: **\$9.54 M (s3442.6)**
- **Brie – Innovation 138 kV Tie:** Construct a greenfield ~1.75 mile of double circuit line, utilizing 2-bundled ACSS Curlew 1033.5 (54/7) conductor, connecting Brie and Innovation stations as well as re-establish the Babbitt - Kirk 138 kV circuit. At Brie 138 kV station will install four 138 kV circuit breakers in two partial strings breaker and half configuration along with a 69.1 MVAR capacitor. Perform remote end work at Innovation, Babbitt, and Kirk 138 kV stations. This project addresses a consequential (for a N-1-1 contingency) load drop event of more than 300 MW for the loads served out of AEP's Anguin and Brie stations while also addressing an overload on the Babbitt – Innovation 138 kV circuit in relation to new customer interconnections in the area. Cost: **\$10.8 M (s3442.7)**

Need Number: AEP-2022-OH077

Process Stage: Submission of Supplemental Project for inclusion in the Local Plan TBD

Previously Presented:

Solutions Meeting 5/9/2023, 12/5/2023

Needs Meeting 12/6/2022

Project Driver: Customer Service

Specific Assumption Reference:

AEP Connection Requirements for the AEP Transmission System (AEP Assumptions Slide 12)

Problem Statement:

Customer Service:

- A customer has requested transmission service at a site north of AEP's existing Jug Street station in New Albany, OH.
- The customer has indicated an initial peak demand of 226 MW with an ultimate capacity of up to 968 MW at the site.
- The customer has requested an ISD of 5/1/2026

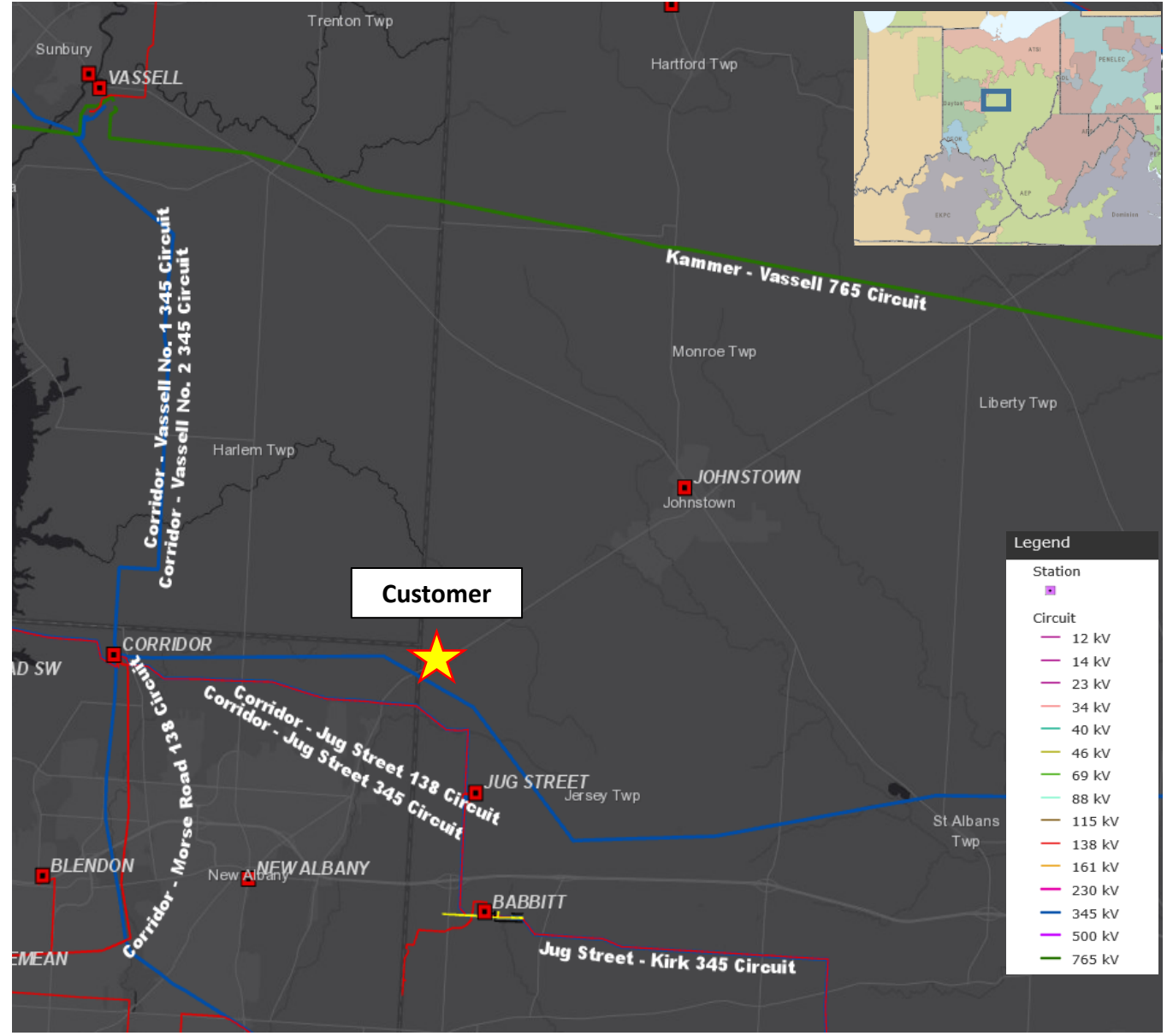

Need Number: AEP-2022-OH077

Process Stage: Submission of Supplemental Project for inclusion in the Local Plan TBD

Solution (continued):

The following work is all direct connect facilities to physically connect demand to the grid.

- **Curleys 345 kV:** Cut into the rerouted Corridor – Innovation 345 kV circuit, utilizing 2-bundled ACSR Falcon 1590 (54/19) conductor, SE rating 2278 MVA, to a new 345 kV Curleys station with (14) 5000 A, 63kA circuit breakers & (2 ±) 158.4 MVAR 345 kV Cap bank, laid out as breaker and a half for future expansion to 3 strings with future configurations to build up to total (10) breaker and half strings. Construct four single circuit lines ~0.1 miles, between Curleys station and the customer; utilizing 2-bundle ACSR Drake 795 (26/7) conductor SE 1800 MVA. The rerouted line, built as double circuit, will establish two 345 kV ties between Bermuda and Curleys stations. Cost: ~~\$55.2 M~~ **\$57.2 M (\$3442.8)**

Reason For Update: As part of further engineering reviews it was determined that the previously proposed capacitor bank at Bermuda would be more efficiently accommodated at Curleys station. The scope update adds the 2nd capacitor at Curleys and removes it from the scope at Bermuda.

Need Number: AEP-2023-OH016

Process Stage: Submission of Supplemental Project for inclusion in the Local Plan TBD

Previously Presented:

Solutions Meeting 5/9/2023, 12/5/2023

Need Meeting 2/17/2023

Supplemental Project Driver: Customer Service

Specific Assumption Reference: AEP Guidelines for Transmission Owner Identified Needs (AEP Assumptions Slide 8)

Problem Statement:

AEP Ohio is requesting a new 138kV delivery point near the Corridor - Jug 138kV circuit by June 2025 to support continued growth in and around the New Albany, Ohio area. Initial load is anticipated to be approximately 24.0 MVA with a future projected load of approximately 100 MVA.

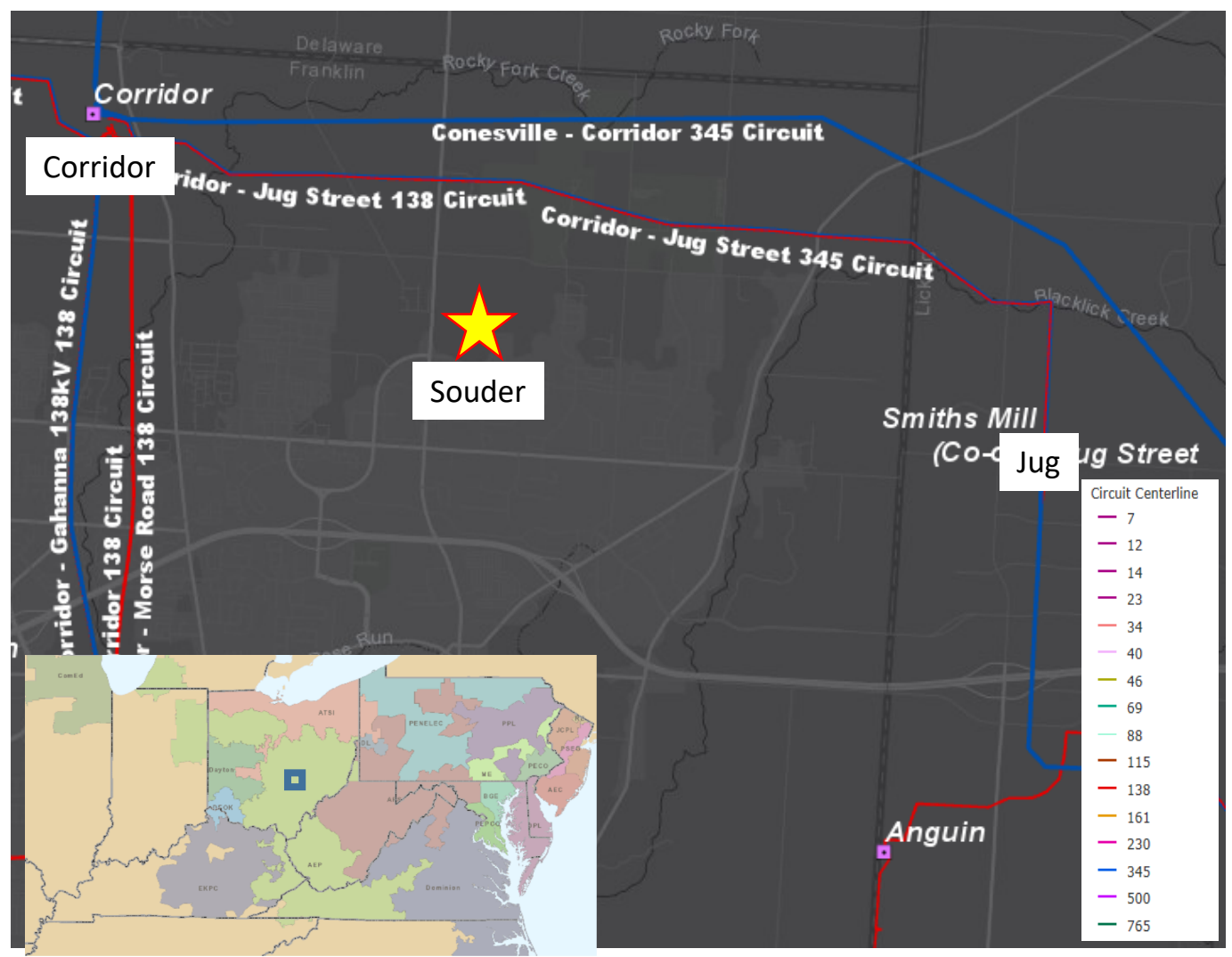

Need Number: AEP-2023-OH016

Process Stage: Submission of Supplemental Project for inclusion in the Local Plan TBD

Solution:

The following work is all direct connect substations to physically connect demand to the grid.

- **Souder 138 kV:** Cut into the Corridor – Green Chapel 138 kV circuit and extend ~1.0 mile of new double circuit line, utilizing 2-bundled ACSR Falcon 1590 (54/19) conductor, SE rating 1118 MVA , to the greenfield Souder station with (5) 80 kA, 4000 A breakers laid out as 5-CB ring bus for future expansion to 6-CB ring. Cost: **\$14.31 M (s3442.9)**

Need Number: AEP-2023-OH019

Process Stage: Submission of Supplemental Project for inclusion in the Local Plan TBD

Previously Presented:

Solutions Meeting 5/9/2023, 12/5/2023

Needs Meeting 2/7/2023

Project Driver: Customer Service

Specific Assumption Reference:

AEP Connection Requirements for the AEP Transmission System (AEP Assumptions Slide 12)

Problem Statement:

Customer Service:

- A customer has requested transmission service at a site north of AEP’s existing Jug Street station in New Albany, OH.
- The customer has indicated that their initial and ultimate peak demand will be 337 MW at the site.
- The customer has requested an ISD of 12/15/2025

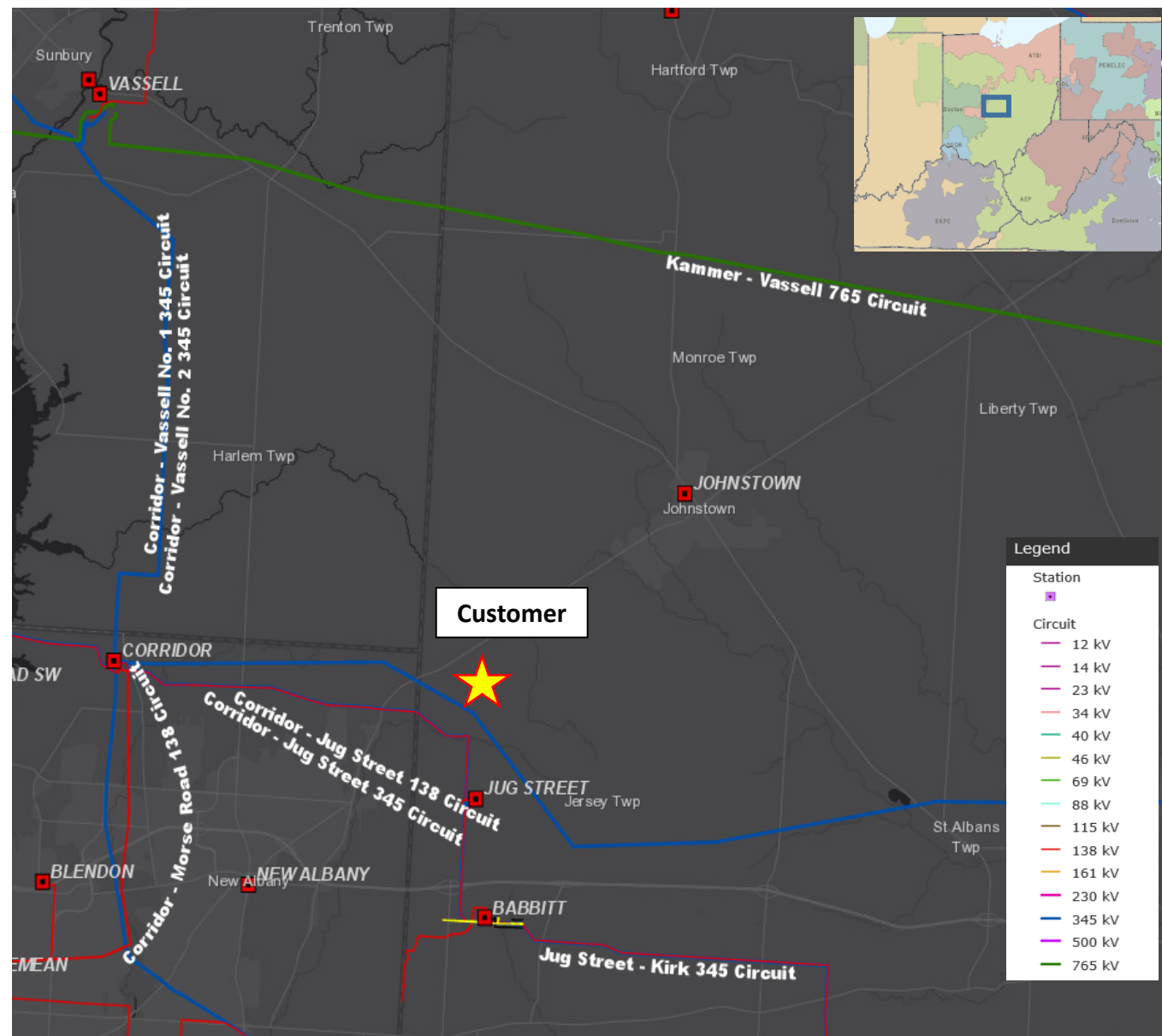

Need Number: AEP-2023-OH019

Process Stage: Submission of Supplemental Project for inclusion in the Local Plan TBD

Solution (continued):

The following work is all direct connect facilities to physically connect demand to the grid.

- **Bermuda 345 kV:** Reroute the Corridor – Innovation 345 kV circuit across the customer’s site utilizing 2-bundled ACSR Falcon 1590 (54/19) conductor, built with double circuit structures, SE rating 2278 MVA, to a new 345 kV Bermuda station with (11) 5000 A, 63kA circuit breakers & ~~(1) 158.4 MVAR 345 kV Cap bank~~, laid out as breaker and a half configuration. Construct four single circuit lines ~0.1 miles, between Bermuda station and the customer; utilizing 2-bundle ACSR Drake 795 (26/7) conductor SE 1800 MVA. Cost: ~~\$60.3 M~~ **\$58.3 M (s3442.10)**

Reason For Update: As part of further engineering reviews it was determined that the previously proposed capacitor bank at Bermuda would be more efficiently accommodated at Curleys station. The scope update adds the 2nd capacitor at Curleys and removes it from the scope at Bermuda.

Need Number: AEP-2023-OH032

Process Stage: Submission of Supplemental Project for inclusion in the Local Plan TBD

Previously Presented:

Solutions Meeting 5/9/2023, 12/5/2023

Needs Meeting 2/17/2023

Project Driver: Customer Service

Specific Assumption Reference:

AEP Connection Requirements for the AEP Transmission System (AEP Assumptions Slide 12)

Problem Statement:

Customer Service:

- A customer has requested transmission service at a site North of AEP's existing Jug Street station in Columbus, OH.
- The customer has indicated an initial peak demand of 50 MW with an ultimate capacity of up to 300 MW at the site.
- Initial customer requested in-service date of January 1, 2026

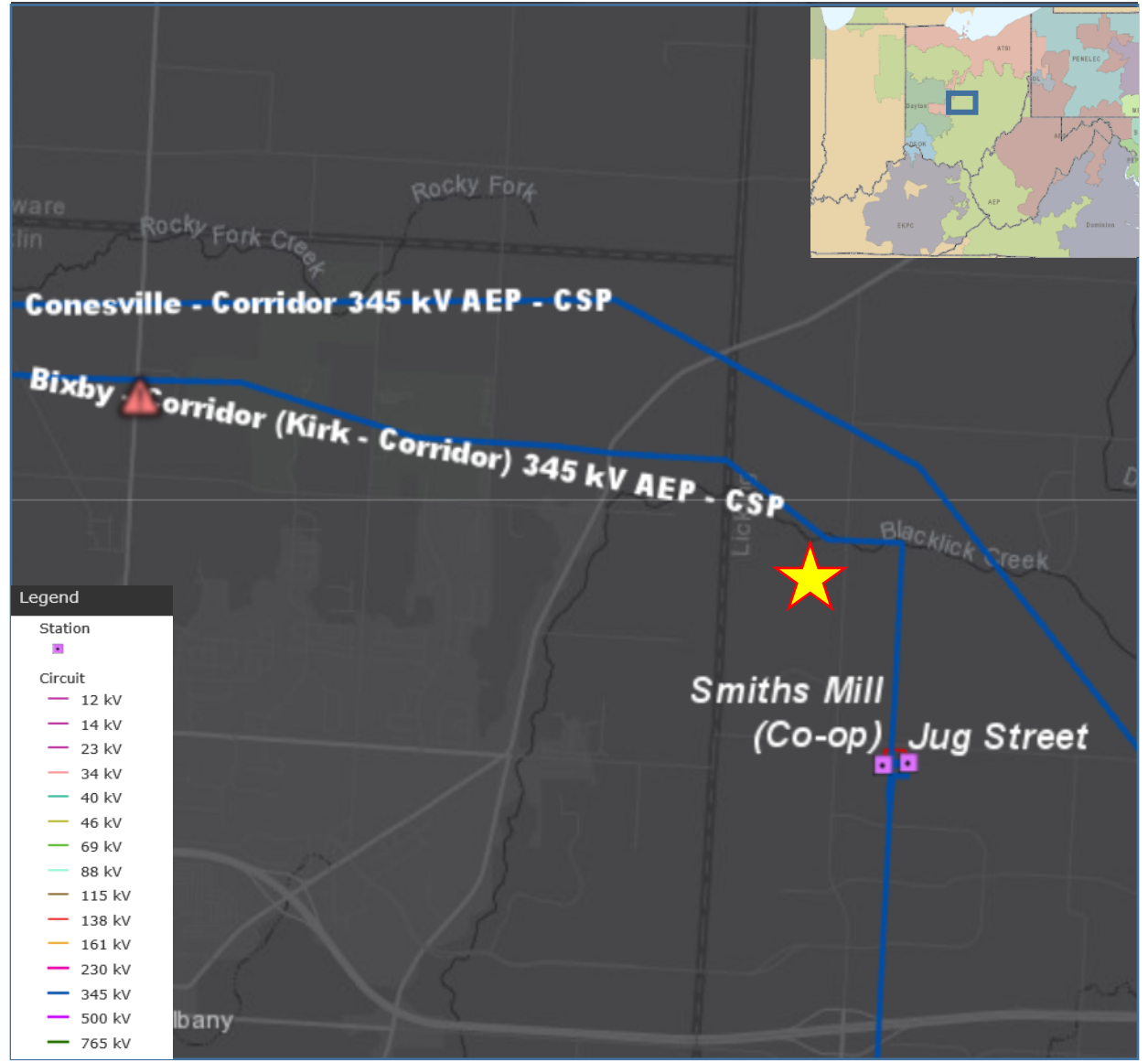

Need Number: AEP-2023-OH032

Process Stage: Submission of Supplemental Project for inclusion in the Local Plan TBD

Solution (continued):

The following work is all direct connect facilities to physically connect demand to the grid.

- **Fiesta 138 kV:** Cut into the Corridor – Green Chapel 138 kV circuit and extend ~ 0.75 miles of new double circuit line, utilizing 2-bundled ACSR Falcon 1590 (54/19) conductor, SE rating 1118 MVA , to the greenfield Fiesta station with (10) 80 kA, 4000 A breakers laid out as breaker and a half for future expansion to 6 strings. Construct 4 - 138 kV tie lines to the customers dead end structures ~0.05 miles utilizing ACSR Drake 795 (26/7) conductor SE 360 MVA. Cost: **\$22.3 M (s3442.11)**

Need Number: AEP-2023-OH040

Process Stage: Submission of Supplemental Project for inclusion in the Local Plan TBD

Previously Presented:

Solutions Meeting 5/9/2023, 12/5/2023

Need Meeting 2/17/2023

Project Driver: Customer Service

Specific Assumption Reference:

AEP Connection Requirements for the AEP Transmission System (AEP Assumptions Slide 12)

Problem Statement:

Customer Service:

- An existing customer served out of AEP's Anguin Station in New Albany, OH, has requested an additional service for a new bulk load addition of 100 MW. This will bring the total load for the customer's site to 350 MW with an ultimate capacity of up to 720 MW.
- Customer requested in-service date of 5/31/2023.

AEP Transmission Zone M-3 Process Rockhopper

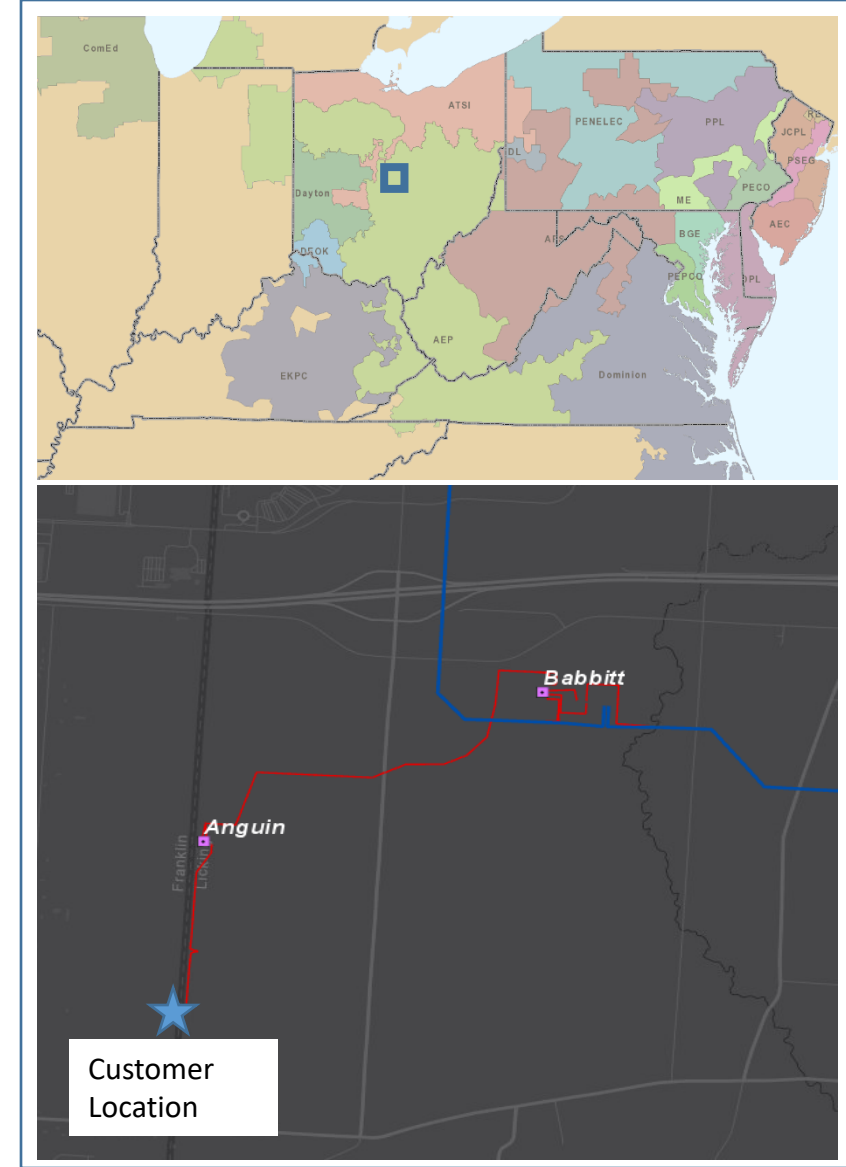

Need Number: AEP-2023-OH040

Process Stage: Submission of Supplemental Project for inclusion in the Local Plan TBD

Solution (continued):

The following work is all direct connect facilities to physically connect demand to the grid.

- **Anguin – Rockhopper 138 kV:** Reconfigure existing Anguin station and install (10) 138 kV, 4000A, 80 kA circuit breakers to feed customer stations at Penguin and QTS North. Build out strings G & H and construct a new greenfield ~0.6 miles double circuit line to customer’s Rockhopper station. Install (2) 69.1 MVAR cap banks at Anguin station Cost: **\$13.2 M (s3442.12)**

Need Number: AEP-2023-OH044

Process Stage: Submission of Supplemental Project for inclusion in the Local Plan TBD

Previously Presented:

Solutions Meeting 5/9/2023, 12/5/2023

Needs Meeting 3/17/2023

Project Driver: Customer Service

Specific Assumption Reference:

AEP Connection Requirements for the AEP Transmission System (AEP Assumptions Slide 12)

Problem Statement:

- A customer has requested service to a new delivery point in New Albany Ohio, just east of Jug Street Station.
- The projected demand for the site is 54 MW with an ultimate capacity of up to 150 MW.
- Customer requested in-service date of 12/19/2025.

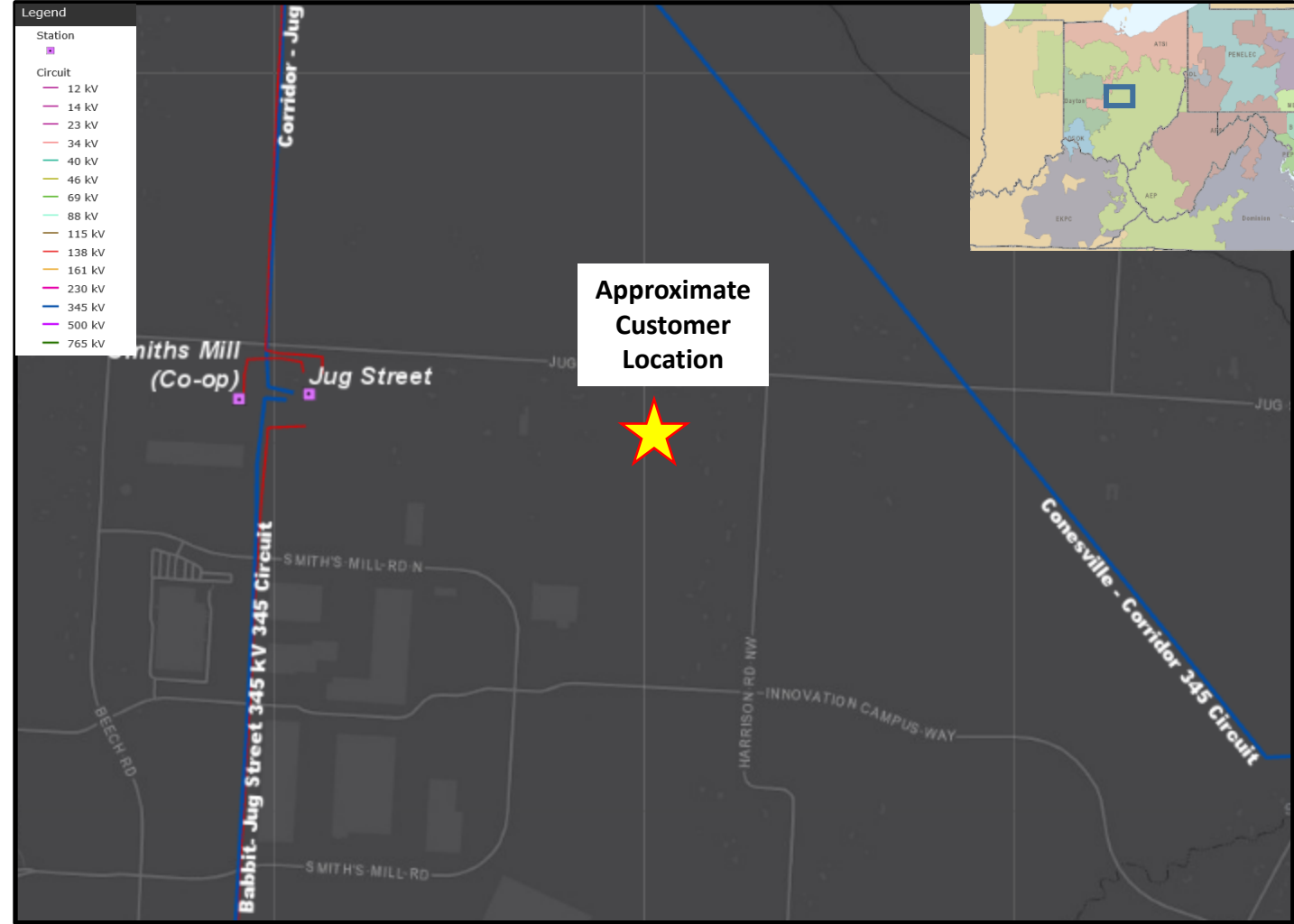

Need Number: AEP-2023-OH044

Process Stage: Submission of Supplemental Project for inclusion in the Local Plan TBD

Solution (continued):

The following work is all direct connect facilities to physically connect demand to the grid.

- **Tasjan 138 kV:** Cut into the Innovation – Green Chapel 138 kV circuit #1 and extend ~ 0.75 miles of new double circuit line, utilizing 2-bundled ACSS Curlew 1033.5 (54/7) conductor, SE rating 1123 MVA, to the greenfield Tasjan station with (4) 80 kA, 4000 A breakers laid out 4-CB ring bus. Construct (2) 138 kV tie lines to the customers dead end structures ~0.05 miles utilizing ACSR Drake 795 (26/7) conductor SE 360 MVA. Cost: **\$18.95 M (\$3442.13)**

Need Number: AEP-2023-OH052

Process Stage: Submission of Supplemental Project for inclusion in the Local Plan TBD

Previously Presented:

Solutions Meeting 5/9/2023, 12/5/2023

Needs Meeting 4/21/2023

Project Driver: Customer Service

Specific Assumption Reference:

AEP Connection Requirements for the AEP Transmission System (AEP Assumptions Slide 12)

Problem Statement:

- An existing customer served out of AEP's Anguin Station in New Albany, OH, has requested an additional service for a new bulk load addition of 100 MW. This will bring the total load for the customers site to 450 MW with an ultimate capacity of up to 720 MW.
- Customer requested in-service date of 3/31/2024.

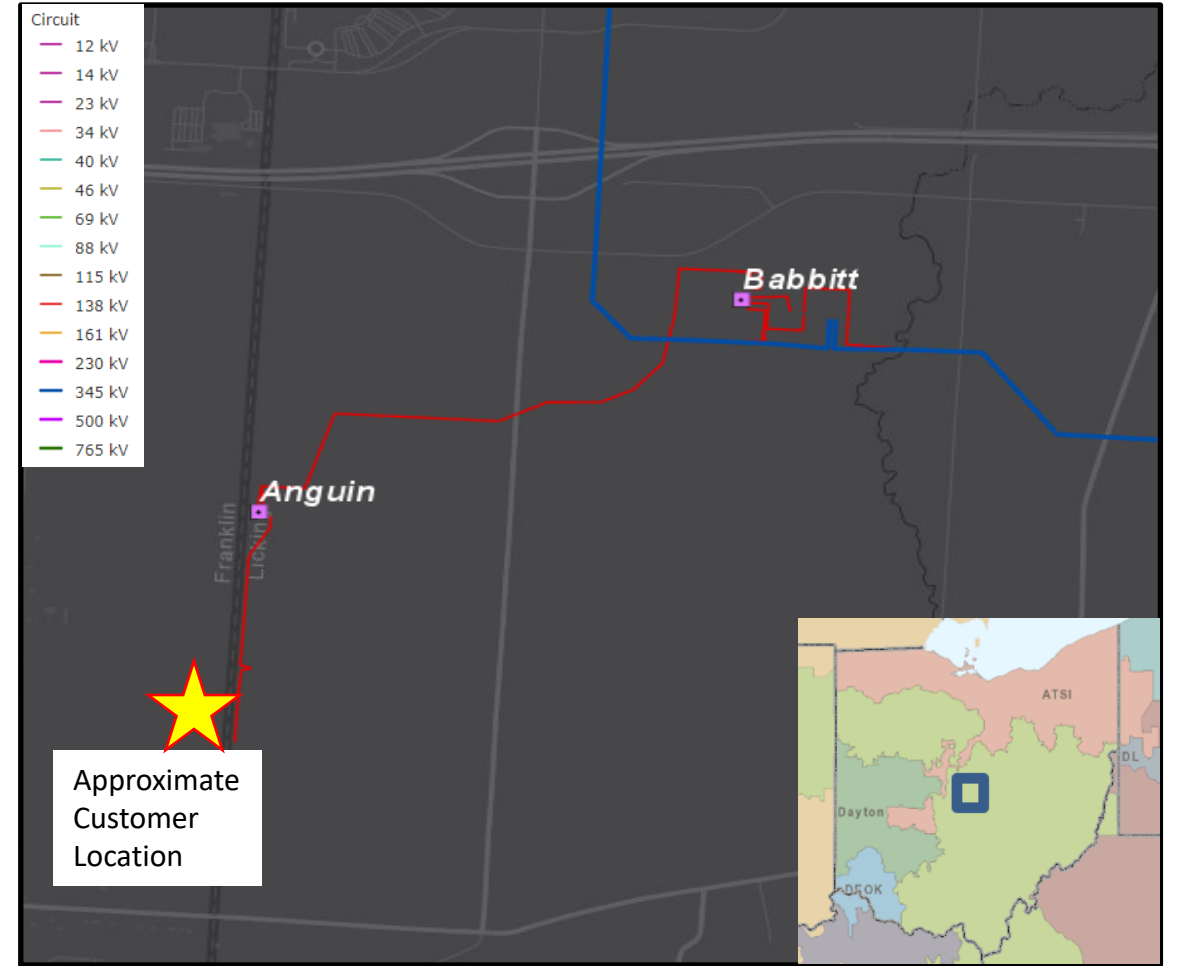



AEP Transmission Zone M-3 Process New Albany , OH

Need Number: AEP-2023-OH052

Process Stage: Submission of Supplemental Project for inclusion in the Local Plan TBD

Solution (continued):

The following work is all direct connect facilities to physically connect demand to the grid.

- **Anguin – Chinstrap 138 kV:** Extend the 138 kV double circuit line to Rockhopper by ~0.22 miles to the new Chinstrap (customer) station. Cost: **\$1.01 M (s3442.14)**

Need Number: AEP-2023-OH063

Process Stage: Submission of Supplemental Project for inclusion in the Local Plan TBD

Previously Presented:

Solutions Meeting 5/9/2023, 12/5/2023

Needs Meeting 4/21/2023

Project Driver: Customer Service

Specific Assumption Reference:

AEP Connection Requirements for the AEP Transmission System (AEP Assumptions Slide 12)

Problem Statement:

- An existing customer served out of AEP's Anguin Station in New Albany, OH, has requested an additional service for a new bulk load addition of 100 MW. This will bring the total load for the customers site to 550 MW with an ultimate capacity of up to 720 MW.
- Customer requested in-service date of 7/31/2024.

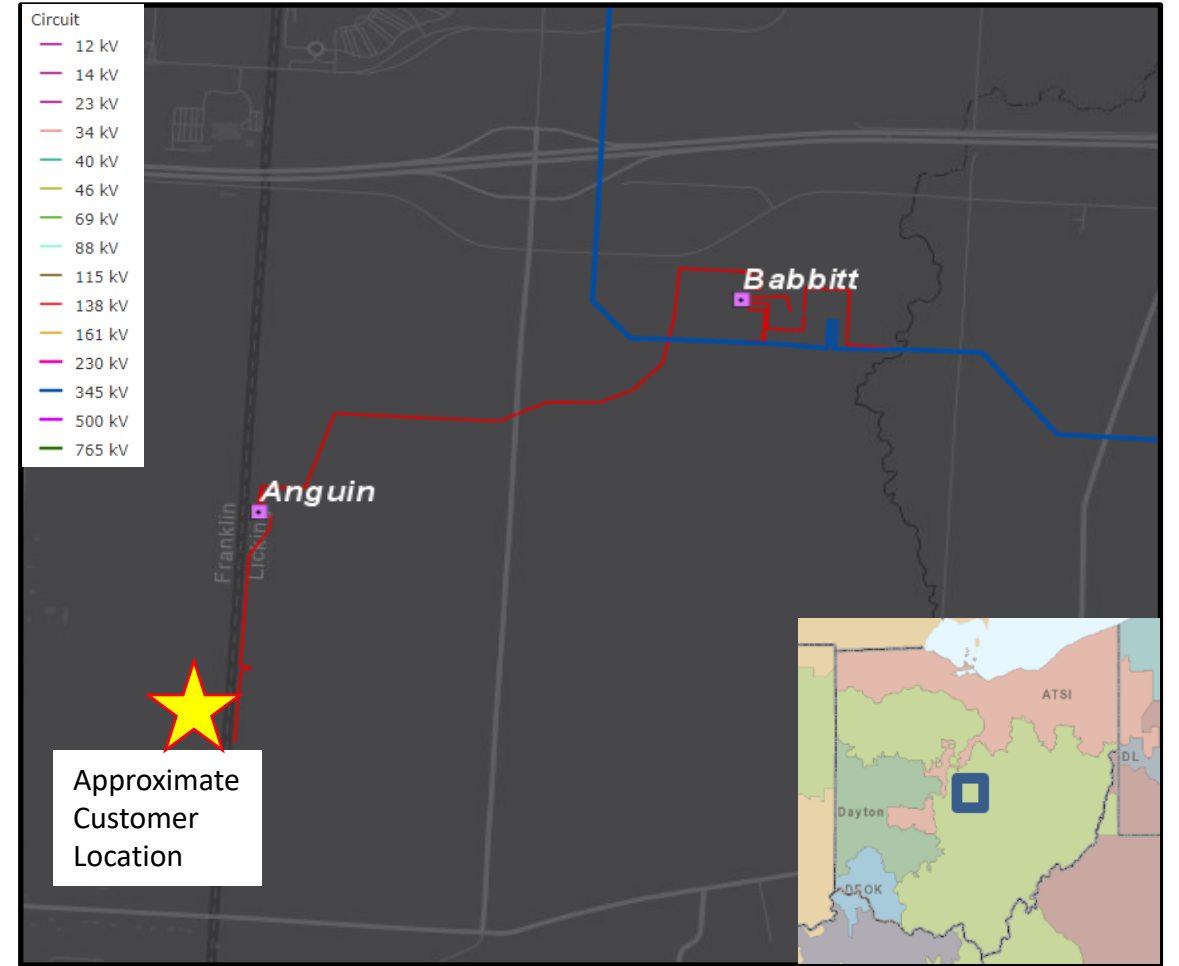

Need Number: AEP-2023-OH063

Process Stage: Submission of Supplemental Project for inclusion in the Local Plan TBD

Solution (continued):

The following work is all direct connect facilities to physically connect demand to the grid.

- **Anguin – NBY-6A 138 kV:** Install (3) 138 kV, 4000A, 80 kA circuit breakers and construct a new greenfield ~0.9 miles double circuit line to customer’s new NBY-6A station. Cost: **\$6.92 M (s3442.15)**

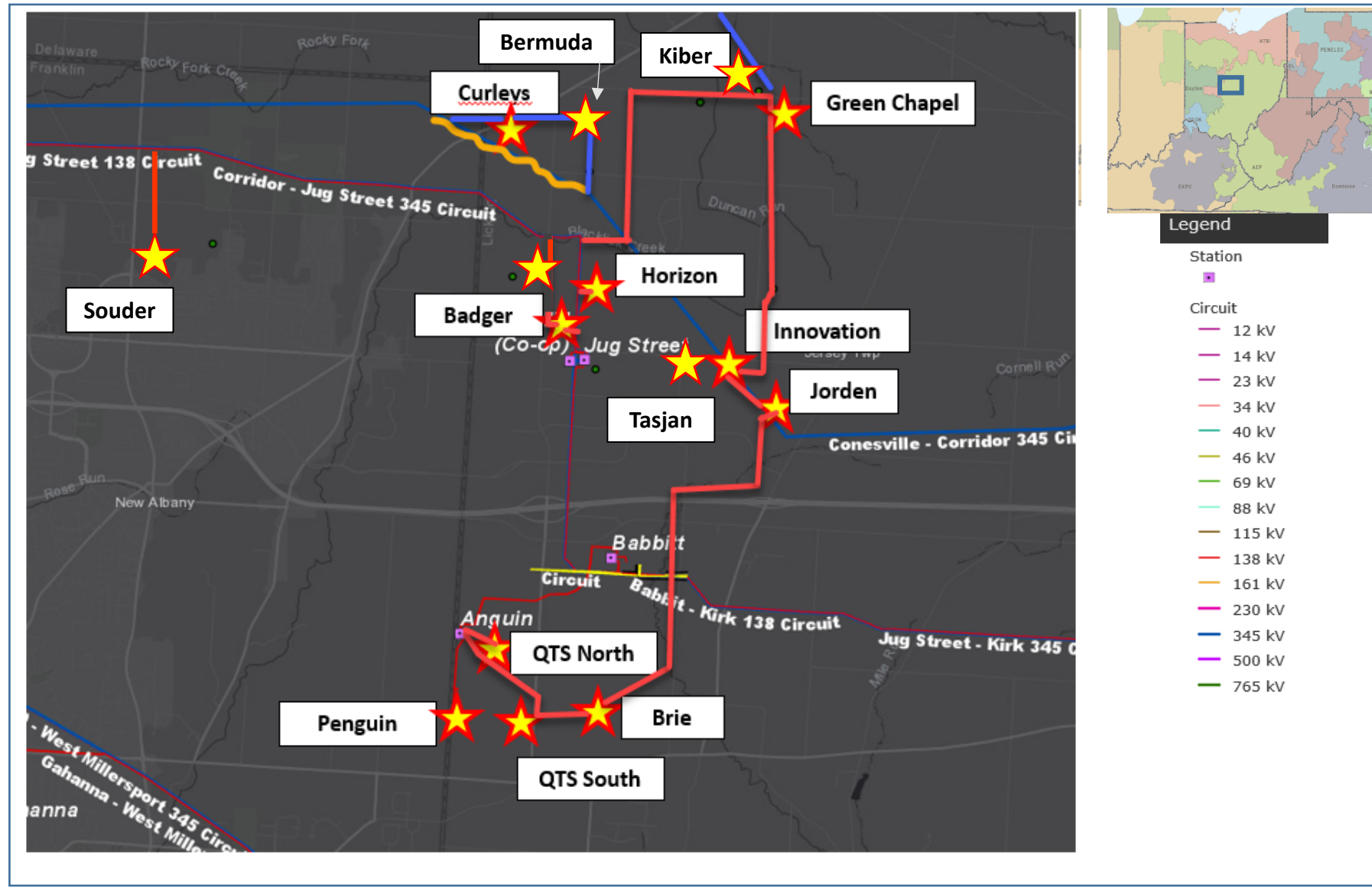

Need Number: AEP-2022-OH023, AEP-2022-OH034, AEP-2022-OH036, AEP-2022-OH045, AEP-2022-OH046, AEP-2022-OH075, AEP-2022-OH077, AEP-2023-OH016, AEP-2023-OH019, AEP-2023-OH032, AEP-2023-OH040, AEP-2023-OH044, AEP-2023-OH052, AEP-2023-OH063

Process Stage: Submission of Supplemental Project for inclusion in the Local Plan TBD

Solution (continued):

The following components are system reinforcements required to serve the load and meet applicable TPL-001, PJM, and AEP planning criteria:

- **Corridor – Vassell 345 kV #1 & #2 Circuits Sag Re-rate:** Replace two structures to mitigate sag issues on the line in order to allow the line to operate to its conductor’s designed maximum operating temperature. Cost: **\$1.88 M (s3442.16)**
- **Kiber Station 138 kV:** Cut-into Green Chapel – Corridor 138 kV circuit to a new Kiber station with (8 ~~3~~) 80 kA 138 kV circuit breakers laid out in a breaker and a half arrangement to install a ~~300~~ 2x150 MVAR STATCOM to support the significant amount of load added to the area. Cost: **\$35 M (s3442.17)**

Reason For Update: As part of further engineering analysis it was determined that in order to be able to physically accommodate the line exits along with two feeds to the STATCOM when taking into account future needs at the station that a total of 8 138 kV breakers would need to be installed initially

- **Green Chapel Cap Banks 138 kV:** Upgrade proposed cap banks at Green Chapel station from (2) 69.1 MVAR to (2) 115.2 MVAR. Cost: **\$3.6 M (s3442.18)**
- **Corridor 138 kV:** Replace (12) 63 kA circuit breakers & cap breakers with 80 kA circuit breakers to improve interrupting capabilities as a result of the new sources in the area. Cost: **\$12.6 M (s3442.19)**
- **Babbitt 138 kV:** Replace (2) 63 kA bus-tie circuit breakers with 80 kA circuit breakers to improve interrupting capabilities as a result of the new sources in the area. Cost: **\$2.15 M (s3442.20)**
- **Jug Street:** Replace CB-C which is an existing 40 kA breaker with a 4000A 80kA 138 kV breaker to address interrupting capability concerns related to the introduction of the new 345 kV source at Innovation. Cost: **\$0.8 M (s3442.21)**

Need Number: AEP-2022-OH023, AEP-2022-OH034, AEP-2022-OH036, AEP-2022-OH045, AEP-2022-OH046, AEP-2022-OH075, AEP-2022-OH077, AEP-2023-OH016, AEP-2023-OH019, AEP-2023-OH032, AEP-2023-OH040, AEP-2023-OH044, AEP-2023-OH052, AEP-2023-OH063

Process Stage: Submission of Supplemental Project for inclusion in the Local Plan TBD

Solution (continued):

The following components are system reinforcements required to serve the load and meet applicable TPL-001, PJM, and AEP planning criteria:

- **Anchor Hocking – Lancaster 69 kV line Rebuild:** Rebuild ~1.16 miles of 69 kV line utilizing ACSR Dove 556.5 (26/7) conductor, SE 142 MVA. As a result of the new customer interconnections in the area, this line will overload under certain N-1-1 scenarios. Cost: **\$2.5 M (s3442.22)**
- **Newark Center 138 kV:** Install high and low side sectionalizing on the 138/69 kV transformer to address overloading of 69 kV lines in the area related to the new customer interconnections under certain N-1-1 scenarios. Cost: **\$2.5 M (s3442.23)**
- **Fremont – West Fremont Sag re-rate 138 kV:** Sag re-rate the 138 kV circuit & upgrade 1200 A switches at Fremont to address a Generation deliverability violation related to the new customer interconnections in the area. Cost: **\$2.0 M (s3442.24)**
- **Fremont – Fremont Center Sag re-rate 138 kV:** Sag re-rate the 138 kV circuit to address a Generation deliverability violation related to the new customer interconnections in the area. Cost: **\$1.5 M (s3442.25)**
- **Dumont 765 kV:** Replace 3000 A circuit breaker at Dumont to address a generation deliverability violation on the Dumont – Sorenson 765 kV branch related to the new customer interconnections in the area. Cost: **\$4.0 M (s3442.26)**

System Upgrades: 68.53M

Direct Connection Cost: 309.77M

Total Estimated Transmission Cost: \$378.3M

Need Number: AEP-2022-OH023, AEP-2022-OH034, AEP-2022-OH036, AEP-2022-OH045, AEP-2022-OH046, AEP-2022-OH075, AEP-2022-OH077, AEP-2023-OH016, AEP-2023-OH019, AEP-2023-OH032, AEP-2023-OH040, AEP-2023-OH044, AEP-2023-OH052, AEP-2023-OH063

Process Stage: Submission of Supplemental Project for inclusion in the Local Plan TBD

Solution (continued):

The following components are system reinforcements that were initially identified by AEP and later confirmed by PJM through their DNH analysis:

- **Vassell – Green Chapel 345 kV line:** Install approximately 12.5-mile long 345 kV transmission between Vassell and Green Chapel stations to mitigate overloading on multiple transmission facilities including other 345 kV transmission lines and 345-138 kV transformers. Cost: **\$75.0 M (s3442.27)**
- **Vassell – Curleys 345 kV line:** Install approximately 12.5-mile long 345 kV transmission between Vassell and Curleys stations to mitigate overloading on multiple transmission facilities including other 345 kV transmission lines and 345-138 kV transformers. Cost: **\$75.0 M (s3442.28)**
- **Vassell 765 & 345 kV stations:** Add 3-345 kV breakers to connect new lines to Curleys and Green Chapel. Cost: **\$10 M (s3442.29)**
- **Green Chapel 345/138 kV station:** Install two 675 MVA, 345/138 kV transformers to connect the new Vassell – Green Chapel 345 kV line to 138 kV system and to mitigate overloading on the other 345/138 kV transformers in the system. Cost: **\$39.2 M (s3442.30)**

System Upgrades: \$199.2 M

Projected In-Service: 10/13/2027

Supplemental Project ID: s3442.1-.30

Project Status: Scoping

Existing:

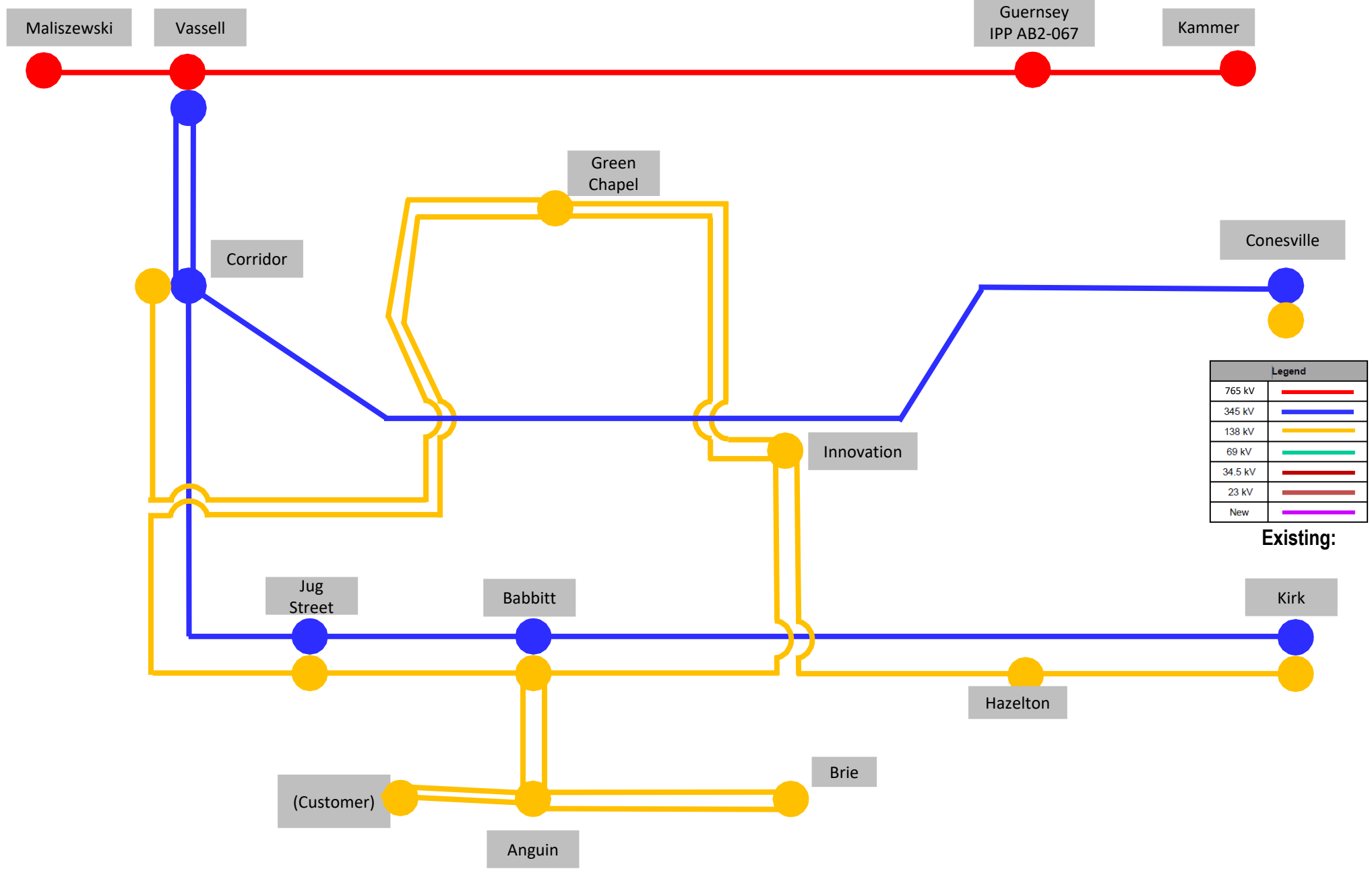

Legend	
765 kV	
345 kV	
138 kV	
69 kV	
34.5 kV	
23 kV	
New	

Existing:

Proposed:

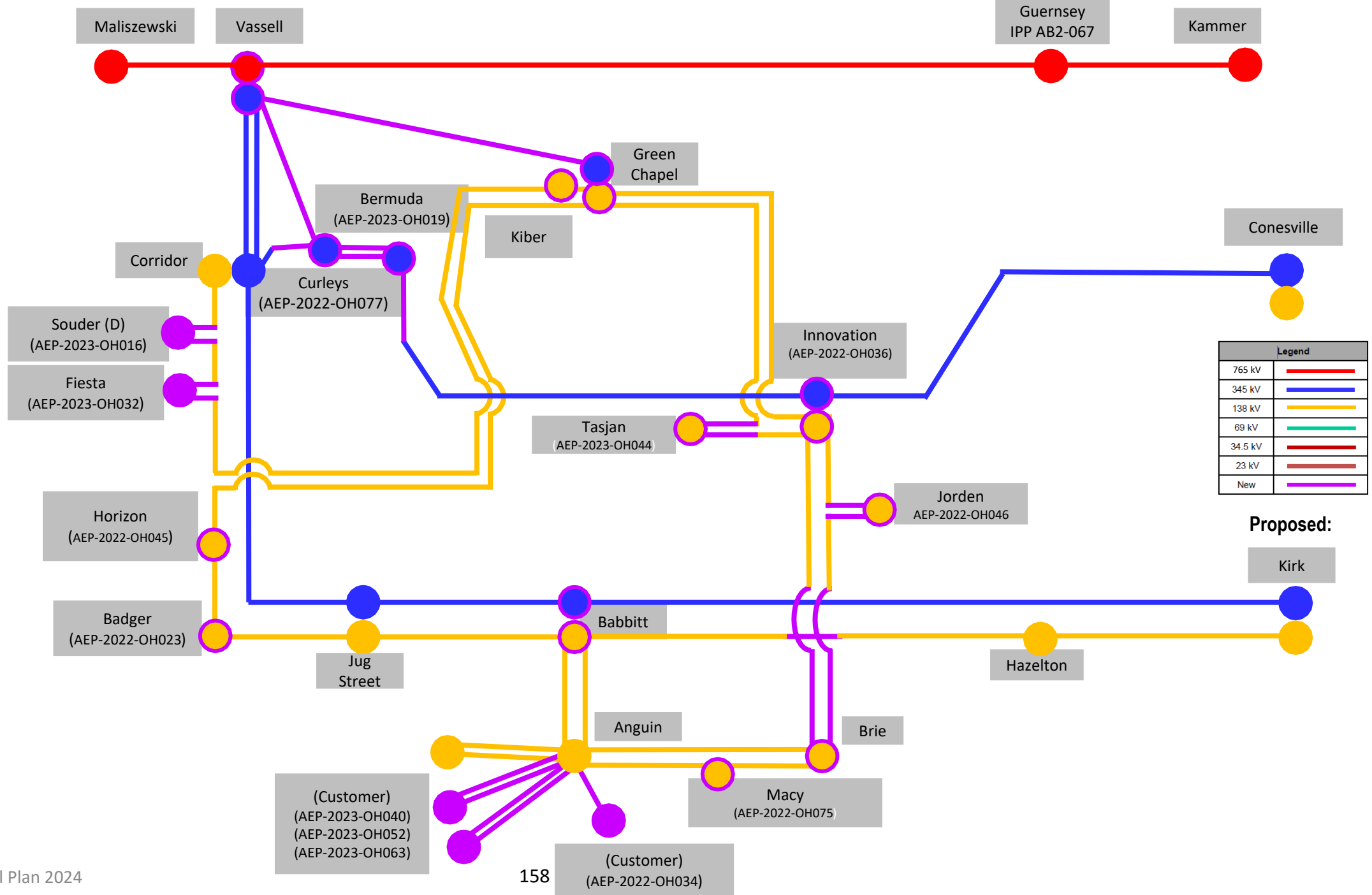

Legend	
765 kV	
345 kV	
138 kV	
69 kV	
34.5 kV	
23 kV	
New	

Proposed:

Need Number: AEP-2023-OH048

Process Stage: Submission of Supplemental Project for inclusion in the Local Plan TBD

Previously Presented:

Solutions Meeting 2/16/2024

Needs Meeting 3/17/2023

Supplemental Project Driver:

Customer Service

Specific Assumption Reference:

AEP Guidelines for Transmission Owner Identified Needs (AEP Assumptions slide 13)

Problem Statement:

- Due to increasing load demand in the Clintonville, Ohio area, AEP Ohio has exhausted capacity at Clinton and Karl stations. AEP Ohio has requested a new 138kV delivery point on the Clinton - Huntley - Karl 138kV Circuit by October 2025 in order to transfer approximately 25 MVA of load from Clinton and 15 MVA of load from Karl station and relieve expected transformer capacity issues at those stations.

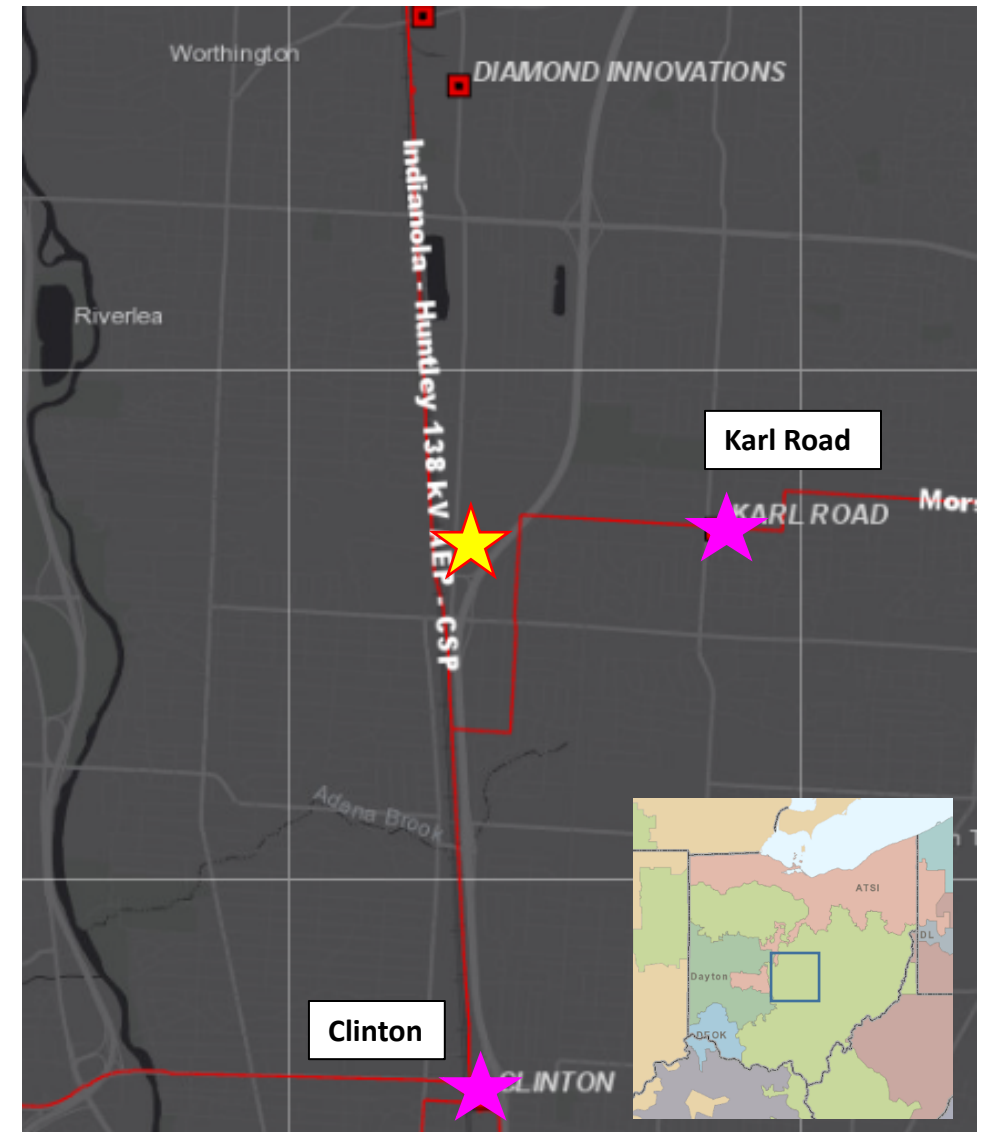

Need Number: AEP-2023-OH048

Process Stage: Submission of Supplemental Project for inclusion in the Local Plan TBD

Solution:

- Giles station 138kV:
 Establish a new three breaker ring bus station named Giles using 3000A 40kA circuit breakers. **Estimated Cost: \$3.88 M** (s3445.1)
- Clinton- Huntley- Karl 138kV Circuit:
 Cut into the existing Clinton - Huntley - Karl 138kV for the Giles Extension line to tap into. **Estimated Cost: \$0.79 M** (s3445.2)
- Giles 138kV Extension:
 Construct a new 0.1 mile double circuit in and out line from the Clinton- Huntley- Karl 138kV Circuit to the new Giles station. **Estimated Cost: \$0.56 M** (s3445.3)
- Remote end relay upgrades at Scherers Switch, Huntley and Blendon stations.
Estimated Cost: \$0.07M (s3445.4)

Total Estimated Transmission Cost: \$5.3 M

Projected In-Service: 10/01/2025

Supplemental Project ID: s3445.1-.4

Project Status: Scoping

Model: 2027 RTEP

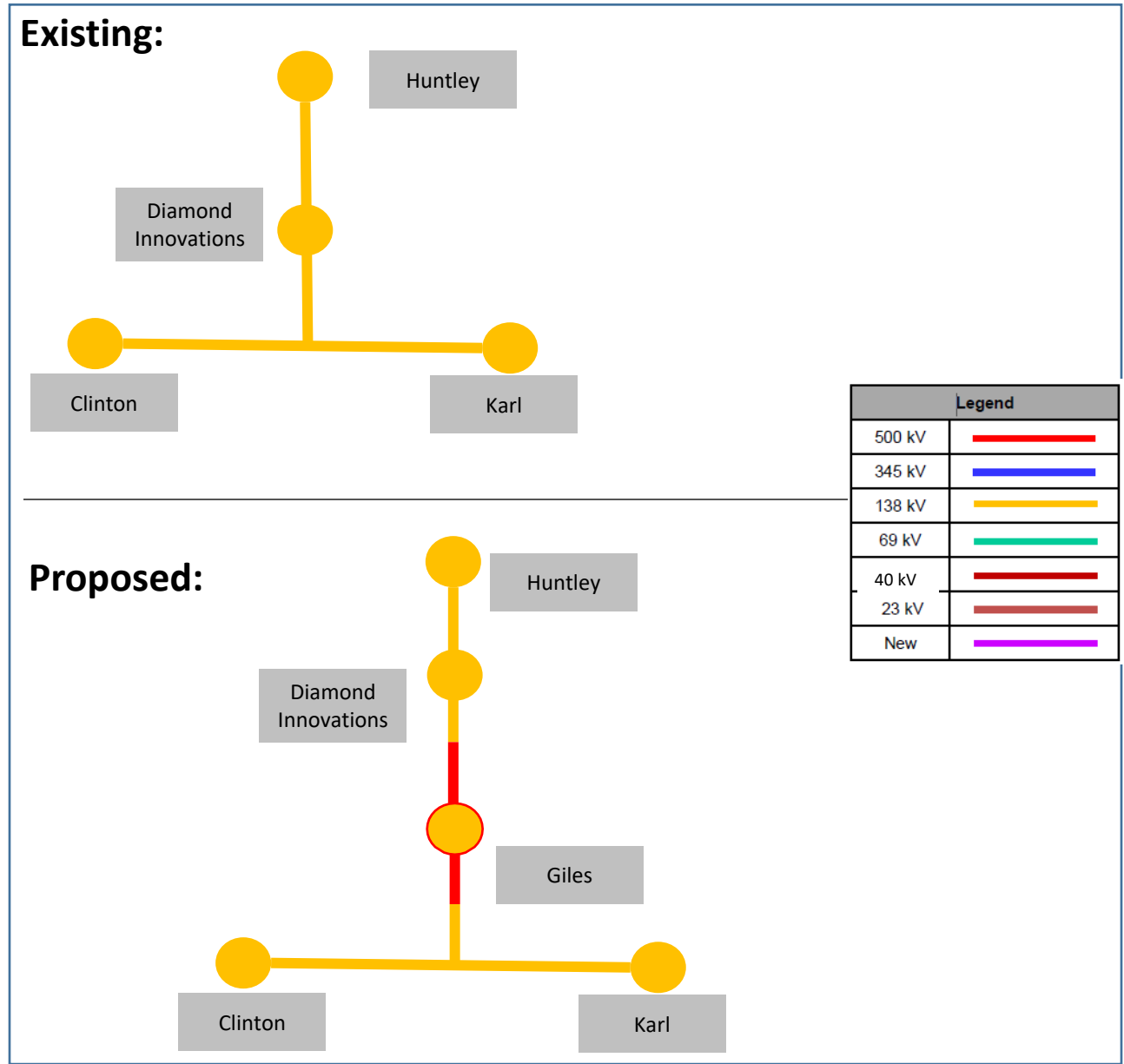

Need Number: AEP-2021-OH050

Process Stage: Submission of Supplemental Project for inclusion in the Local Plan TBD

Previously Presented:

- Solutions Meeting 01/19/2024
- Needs Meeting 09/17/2021

Project Driver:

Equipment Material/Condition/Performance/Risk

Specific Assumption Reference:

AEP Guidelines for Transmission Owner Identified Needs (AEP Assumptions Slide 13)

Problem Statement:

Marion Road 138 kV

138 kV CB-2, CB-3, CB-4, & CB-5

- Breaker Age: 1972
- Interrupting Medium: Oil
- Fault Operations: 10 (CB-2), 16 (CB-3), 4 (CB-4), 5 (CB-5)
- Additional: CB-2, 3, 4, 5, are 138 kV BZO oil filled type breakers. These breakers are oil filled without oil containment; oil filled breakers have much more maintenance required due to oil handling. CB-2 & CB-3 has exceeded the manufacturer's recommended (10) number of full fault operations.

138 kV CB-6 & CB-7 and 40 kV CB-17

- Breaker Age: 2006 CB 6 & 7 and 1996 CB 17
- Interrupting Medium: SF6
- Fault Operations: 11 (CB-6), 10 (CB-7), and 7 (CB-17)
- Additional: CB 6 & 7 have meet or exceeded the manufacturer's recommended (10) number of full fault operations. CB-17 has exceeded the manufacturer's recommended (6) number of full fault operations

40 kV CB-10

- Breaker Age: 1964
- Interrupting Medium: Oil
- Fault Operations: 0
- Additional: CB-10, is a 40kV FKA oil filled type breaker. This breaker is oil filled without oil containment; oil filled breakers have much more maintenance required due to oil handling. GE provides no support for this circuit breaker and spare parts are increasingly more difficult to obtain; components are often taken from out of service units with remaining usable parts.



Need Number: AEP-2021-OH050

Process Stage: Submission of Supplemental Project for inclusion in the Local Plan TBD

Previously Presented:

Solutions Meeting 01/19/2024

Needs Meeting 09/17/2021

Problem Statement (continued):

138 kV CS-AA

- Breaker Age: 1990
- Interrupting Medium: SF6
- Fault Operations: 0
- Additional: CS-AA, is a 138kV SF6 type switcher. This type of circuit switchers have no gas monitor and currently in-service units on the AEP system have experienced 110 malfunctions from May 2000 to August 2019. Failed operational components including high contact resistance, gas loss, and interrupter failure represent half of these malfunctions. Two malfunctions of note were catastrophic equipment failures involving failures to trip. Parts are expensive, especially because interrupters can only be replaced, not repaired, as they are hermetically sealed.

138/40/13 kV Transformers 4

- Transformer age: 1969
- Transmission owned
- Additional: Transformer 4, the asset health score is low driven primarily by short circuit causes. The Short Circuit portion of the score is driven by the age of this unit's insulating materials. As the insulating paper materials age, they become brittle.

138/40/13 kV Transformers 5 & 6

- Transformer age: 1961
- Transmission owned
- Additional: Transformers 5 & 6, the asset health scores are low driven primarily by short circuit and accessory causes. The Short Circuit portion of the score is driven by the elevated levels of Carbon Dioxide which is currently at IEEE Level 3. This level indicates high decomposition of the paper insulating materials. The Accessory portion of the score is driven by the LTC. The Ethylene levels currently exceed Acetylene within the LTC. This is an early indicator of deteriorated internal components

Relaying:

Currently, 277 of the 293 relays (95% of all station relays) are in need of replacement. All 277 of these are of the electromechanical and static type which have significant limitations with regards to spare part availability and fault data collection and retention. In addition, these relays lack of vendor support.



Need Number: AEP-2021-OH050

Process Stage: Submission of Supplemental Project for inclusion in the Local Plan TBD

Solution:

- **Marion Road station:** Rebuild on the existing site with 9- 138kV 63kA 3000A breakers and utilizing one of the original breakers that is in good health to create a ten-breaker ring bus. Add a 28.8 MVAR 138kV Cap Bank. Construct a greenfield 40kV yard with two new 50MVA 138/40kV transformers to support the three 40kV customers served from the station. Use existing breaker 16 and 22 on the low-side of the transformers. Replace breakers 17 and 10 with existing breakers 15 and 21 which are in good health. Install a new DICM and remove the existing control house. **Estimated Cost: \$35.38M (s3446.1)**
- **Bixby - Marion Rd 138kV:** As part of the station reconfiguration the double circuit 138 kV line from Marion to LSII and Harrison will be rerouted into the new 138kV yard with a new 0.15-mile extension using ACSR Drake 795 (26/7) conductor (SE 360 MVA). **Estimated Cost: \$1.14M. (s3446.2)**
- **Marion Road – Universal 40 kV:** reroute the existing 40 kV service (Royal Building Products) T-line into the new 40 kV yard with a new 0.24 miles extension using ACSR Dove 556.5 (26/7) conductor (SE 142 MVA). **Estimated Cost: \$0.90M (s3446.3)**
- **Marion Road – Champion Avenue 40 kV:** reroute the existing 40 kV service (ITC Manufacturing) T line into the new 40 kV yard with a new 0.19-mile extension using ACSR Dove 556.5 (26/7) conductor (SE 142 MVA). **Estimated Cost: \$0.93M (s3446.4)**
- **Marion Road – Columbus Auto Shredding 40 kV:** Construct a greenfield ~0.15-mile single circuit line to Columbus Auto Shredding POI using ACSR Dove 556.5 (26/7) conductor (SE 142 MVA). **Estimated Cost: \$0.92M (s3446.5)**
- **Mound Street, Harrison, LSII:** Remote end work will be performed at Mound, Harrison, and LSII stations to coordinate with the work at Marion Road. **Estimated Cost: \$0.89M (s3446.6)**

Total Estimated Transmission Cost: \$40.16 M

Supplemental Project ID: s3446.1-.6

Projected In-Service: 03/2027

Project Status: Scoping

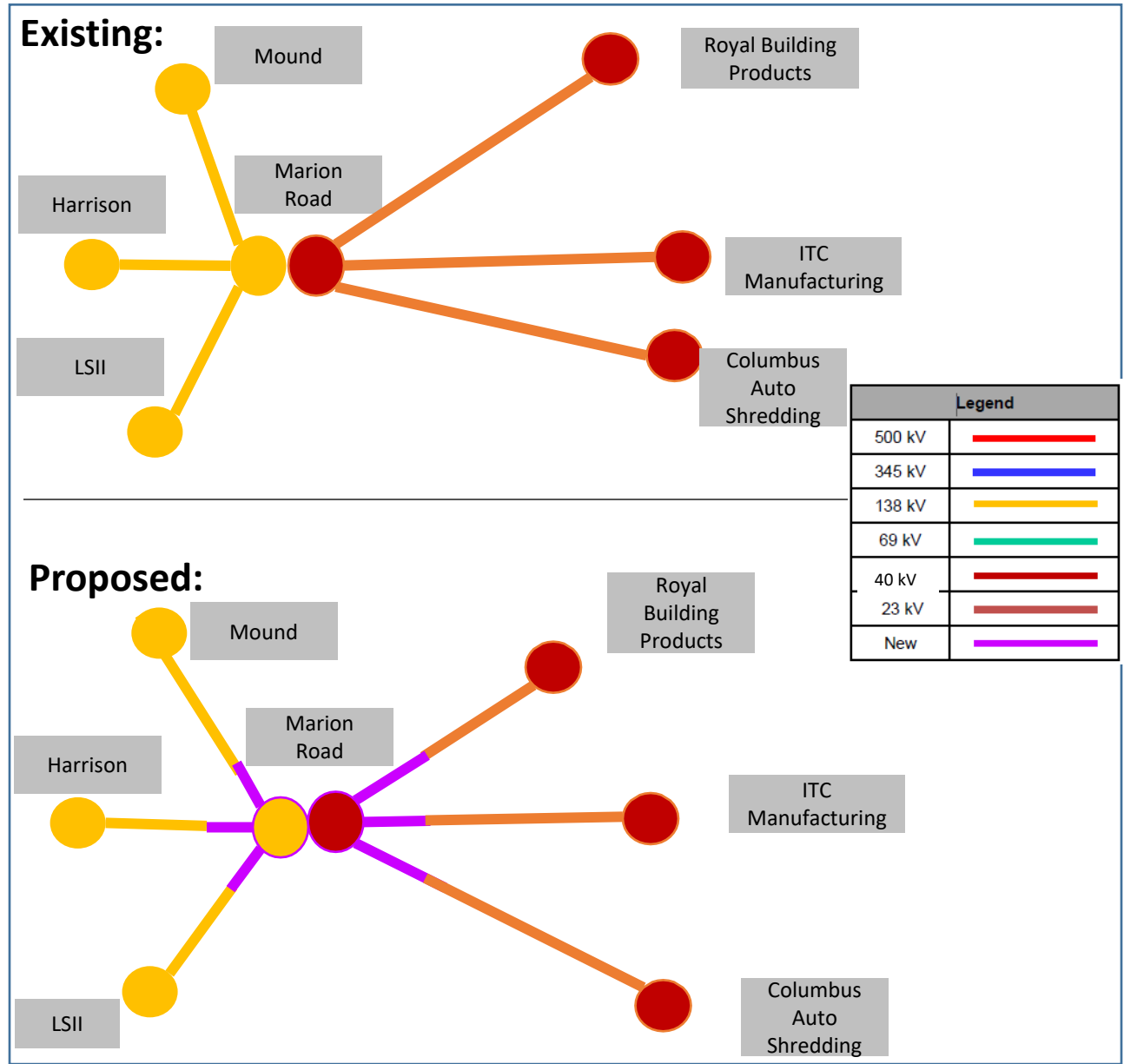

Revision History

2/21/2024 – V1 Added slides #1-67, s3133.1-.15 through s3148.1

3/20/2024 – V2 Added slides #68-81, s3211.1-.7 through s3215.1-.7

5/20/2024 – V3 Added slides #82-83, s3301.1

5/21/2024 – V4 Added slides #84-98, s3302.1-.2 through S3308.1-.3

9/16/2024 – V5 Added slides #99-163, s3387.1 through S3390.1, S3440.1-.6 through S3442.1-.30, S3445.1-.4 and S3446.1-.6