

Submission of Supplemental Projects for Inclusion in the Local Plan

AEP Transmission Zone M-3 Process Anguin Station

Need Number: AEP-2018-OH002

Process Stage: Submission of Supplemental Project for inclusion in the Local Plan 1/29/2020

Previously Presented:

Needs Meeting 10/25/2018

Solutions Meeting 11/22/2019

Project Driver:

Customer Service

Specific Assumption Reference:

AEP Guidelines for Transmission Owner Identified Needs (AEP Assumptions Slide 7)

Problem Statement:

A new customer delivery point has been requested.

- Initial load of 150MW with permanent service available by Q1-2020.
- Ultimate load for this customer is projected to reach 720MW as early as Q4 2026.
- 10 MW of distribution construction power for this customer is required in May 2019. 7 MW of distribution construction power for an existing customer planning to expand is also required in 2019. The existing customer has reserved distribution capacity for up to 10 years of expansion activity. As a result, AEP-Ohio has requested a 138kV delivery Point at Babbitt station to serve a “temporary” skid station for up to 10 years.
- Additional large customers are in discussions to take service in this area.
- Facilities will be designed to accommodate anticipated future load but only facilities required to serve committed load will be constructed.

As part of the DNH analysis, PJM has identified a violation of 300 MW of load drop for loss of Jug Street-Babbitt 138 kV line plus Kirk-Babbitt 138 kV line with the addition of this project.

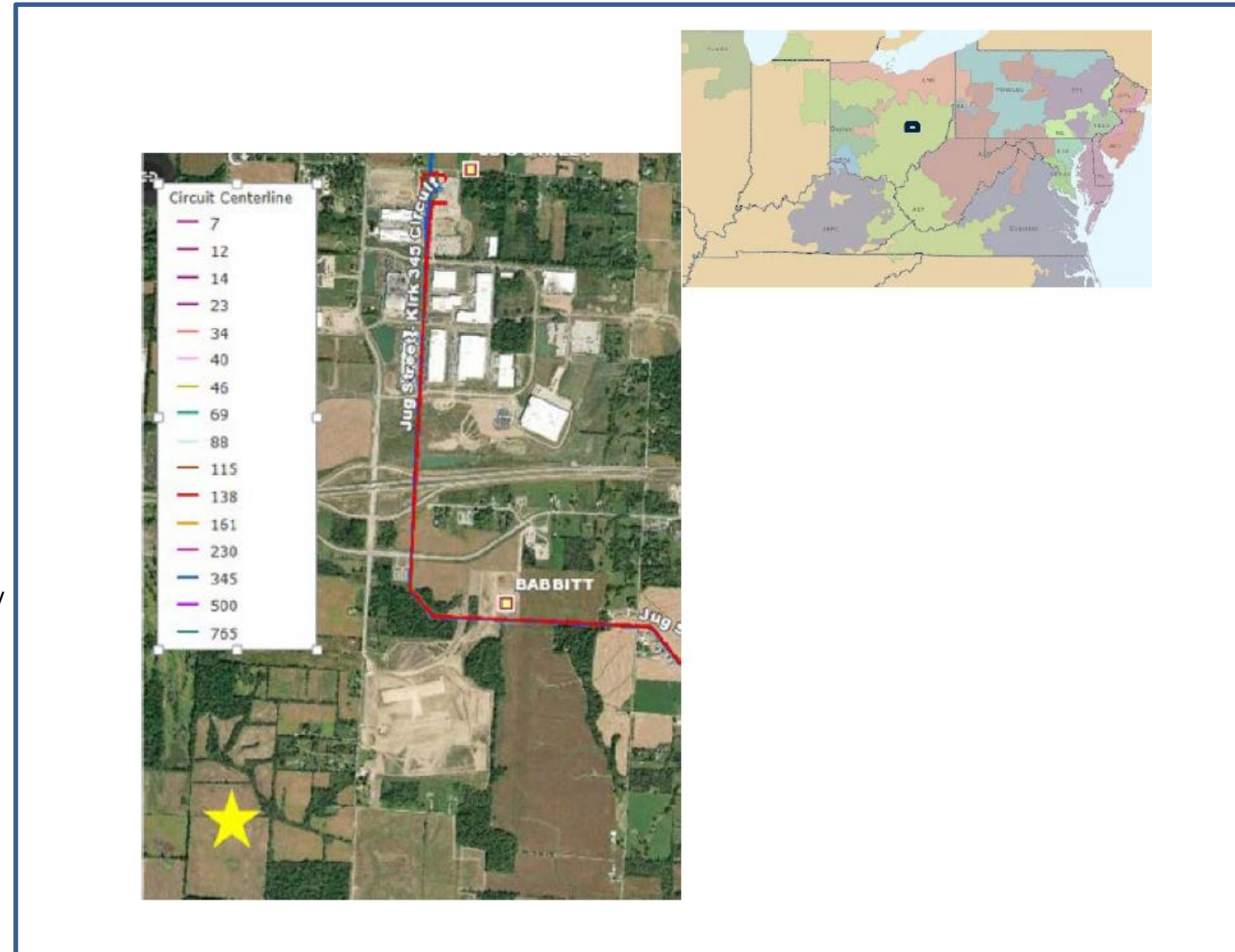

AEP Transmission Zone M-3 Process Anguin Station

Need Number: AEP-2018-OH002

Process Stage: Submission of Supplemental Project for inclusion in the Local Plan 1/29/2020

Selected Solution:

- Construct 2-138 kV circuits (~1.5 miles) from Babbitt Station to a new Anguin Station using 2 bundled 1033 ACSS conductor per circuit. **(S2139.1) Estimated Cost: \$15.2M**
- Construct 2-138 kV circuits (~.4 miles) from Anguin Station to a new customer station using 795 ACSS conductor. **(S2139.2) Estimated Cost: \$2.5M**
- At the existing 138 kV Babbitt Station, install 4-138 kV 4,000A 63kA breakers to accommodate the new 138 kV double circuit to Anguin Station, 2-138kV 4,000A 63kA bus tie breakers, a 57.6MVAR capacitor bank with protection, and a 138kV 4,000A 63kA CB to serve AEP-Ohio's requested delivery point. **(S2139.3) Estimated Cost: \$6.6M**
- Construct Anguin Station in a breaker and a half arrangement utilizing 8-138 kV 4,000A 63kA breakers and 2-57.6MVAR capacitor banks with protection. **(S2139.4) Estimated Cost: \$24.0M**
- **Cut into existing Jug Street-Kirk 345kV circuit into a new 345 kV yard at Babbitt Station. Relocate Babbitt-Kirk 138kV circuit exit at Babbitt Station. (S2139.5) Estimated Cost: \$3.3M**
- **At Babbitt Station, install 3-3,000A, 63kA CB's in ring bus configuration at the 345 kV yard, a new 345/138kV 675 MVA transformer, and a new control house. Install 1-138 kV capacitor bank (54.7 Mvar) with high side protection. Install 9-138 kV, 4,000A 63kA CB's including a new 138kV yard and two short lines to connect both yards. Cost includes purchase of land for the required expansion. (S2139.6) Estimated Cost: \$39.4M**
- **Kirk 138kV –Update line relaying. (S2139.7) Estimated Cost: \$0.3M**

Total Estimated Cost: \$91.3M

Projected In-Service: 6/1/2021

Supplemental Project ID: S2139.1-7

Project Status: Scoping

Model: 2024 RTEP

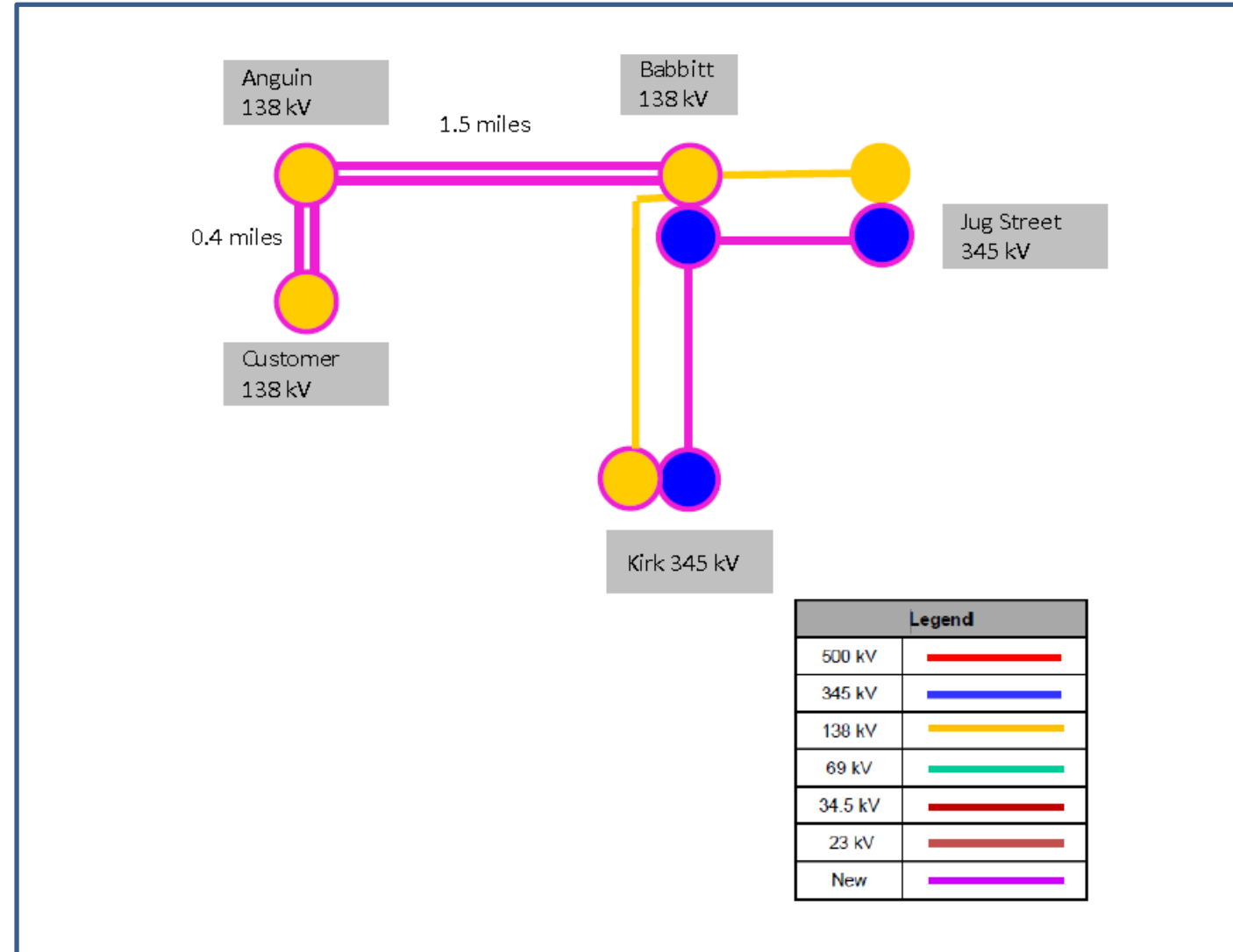

AEP Transmission Zone M-3 Process Coshocton Area Improvements

Need Number: AEP-2018-OH006

Process Stage: Submission of Supplemental Project for inclusion in the Local Plan 1/29/2020

Previously Presented:

Needs Meeting 10/28/2018

Solutions Meeting 11/22/2019

Project Driver:

Equipment Condition/Performance/Risk and Customer Service

Specific Assumption Reference:

AEP Connection Requirements for the AEP Transmission System (AEP Assumptions Slide 7)

Problem Statement:

Customer Service:

- Customer #2: Holmes-Wayne Co-op (at Stillwell) and AEP Ohio (at Glenmont) are currently served via a radial 34.5 kV (12.58 mi) line. This radial line has consistently been one of the worst performing line over the last 10 years. The Stillwell delivery point has accumulated 1.7 million CMI over the past five years. Over the last 10 years (2008-2017), Stillwell delivery point has averaged nearly 875,000 CMI/ year.
- Customer #3: L.R. and Holmes-Wayne members are currently served via a radial 69 kV (24.1 mi) line. The North Liberty to Jelloway radial line is 9.50 miles and the Ripley to Loudonville radial line is 14.16 miles. Their total load is 8.73 MVA and they have experienced 1.13 million CMI over the last three years.

Problem Statement Continued on Next Slide...

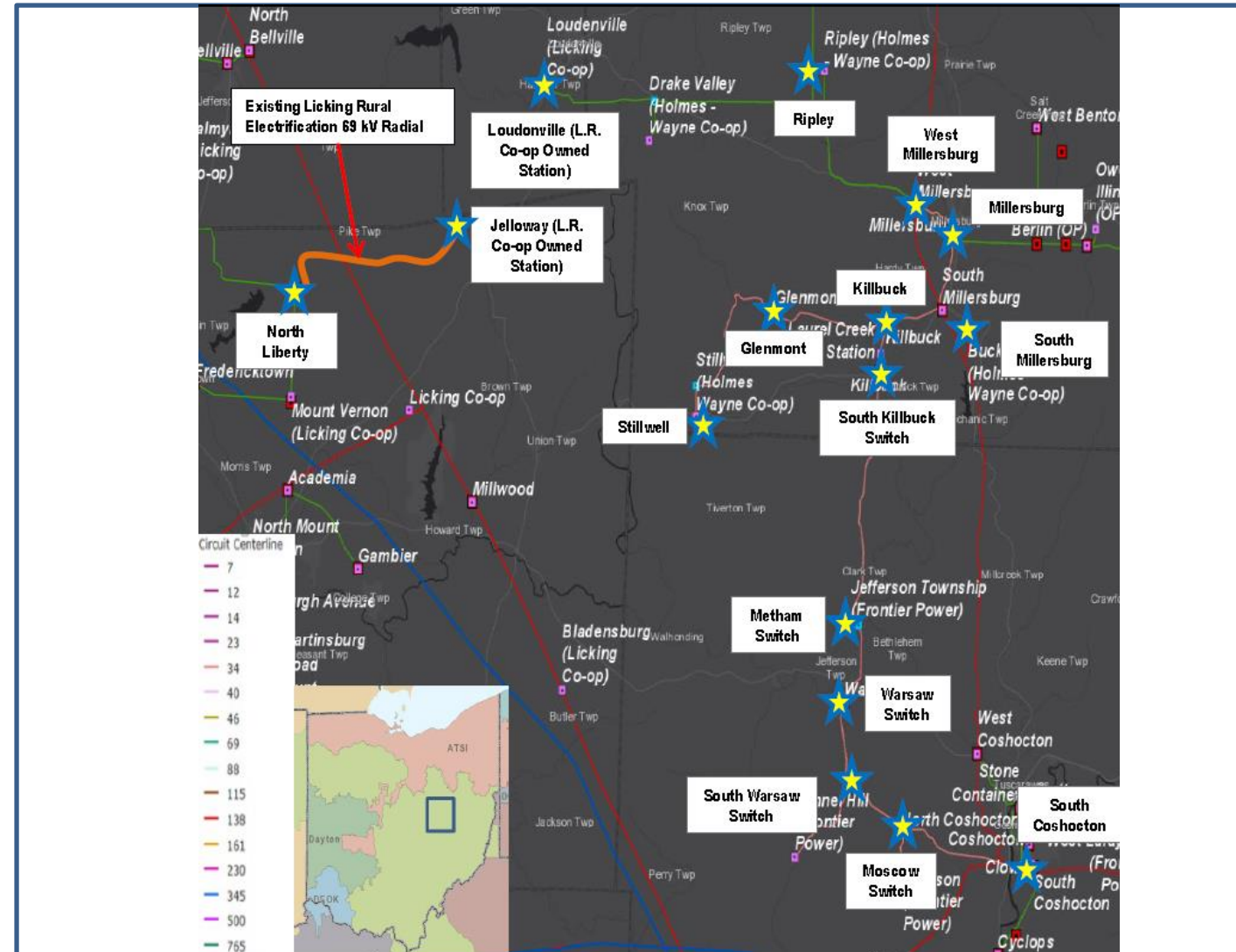

AEP Transmission Zone M-3 Process Coshocton Area Improvements

Problem Statement Continued:

Equipment Material/Condition/Performance/Risk:

- The Killbuck–South Coshocton 34 kV line (30.18 mi) was constructed in 1926 using wood pole structures and conductor ranging from 3/0 Copper (23 MVA rating) to 336.4 ACSR (37 MVA rating). There are 144 open A conditions on this line, including rotten cross-arms, burnt/broken insulators, and loose/broken conductor hardware. The Killbuck–South Coshocton 34 kV line has experienced over 1 million CMI over the past three years.
- The Killbuck–South Millersburg 34 kV (2.59 mi) line was constructed in the 1920's using wood pole structures with 336.4 ACSR (36 MVA rating). There are 53 open A conditions on this line, including rotten cross-arms, burnt/broken insulators, and loose/broken conductor hardware. The Killbuck–South Millersburg 34 kV line has experienced over 1 million CMI over the past three years.
- At South Coshocton 69 kV circuit breaker 'K' (fault ops 18), 34.5 kV circuit breakers 'A' (fault ops 3), 'B' (fault ops 7), 'C' (fault ops 72), 'D' (fault ops 0), 'E' (fault ops 0), and 'G' (fault ops 2) are 'FK' oil-filled breaker (vintage 1946 -1973). These oil type breakers have extensive maintenance and oil handling requirements. There is a potential for oil spills during fault operations and maintenance. The FK model is no longer supported by the manufacturer making spare part availability scarce.
- The South Coshocton 138 kV circuit breaker 'H' has had 11 malfunctions, 3 of which are confirmed to be related to low gas. This HS145-3000 model is prone to low gas malfunctions. The South Coshocton 138/34.5 kV transformer's dielectric strength has declined for the past seven years. Concentrations of CO₂ are elevated as well. These conditions indicate that the insulating paper is deteriorating.
- The South Millersburg 34.5 kV circuit breakers 'A' (fault ops 3) and 'B' (fault ops 21) are 'FK' oil-filled breakers (vintage 1951 and 1953 respectively). These oil type breakers extensive maintenance and oil handling requirements. The FK model is no longer supported by the manufacturer making spare part availability scarce.
- The South Millersburg 138/34.5 kV transformer has elevated moisture levels for at least seven years with a recent sharp increase. The dielectric strength has corresponding decreased since 2016. Concentrations of CO₂ are also elevated.

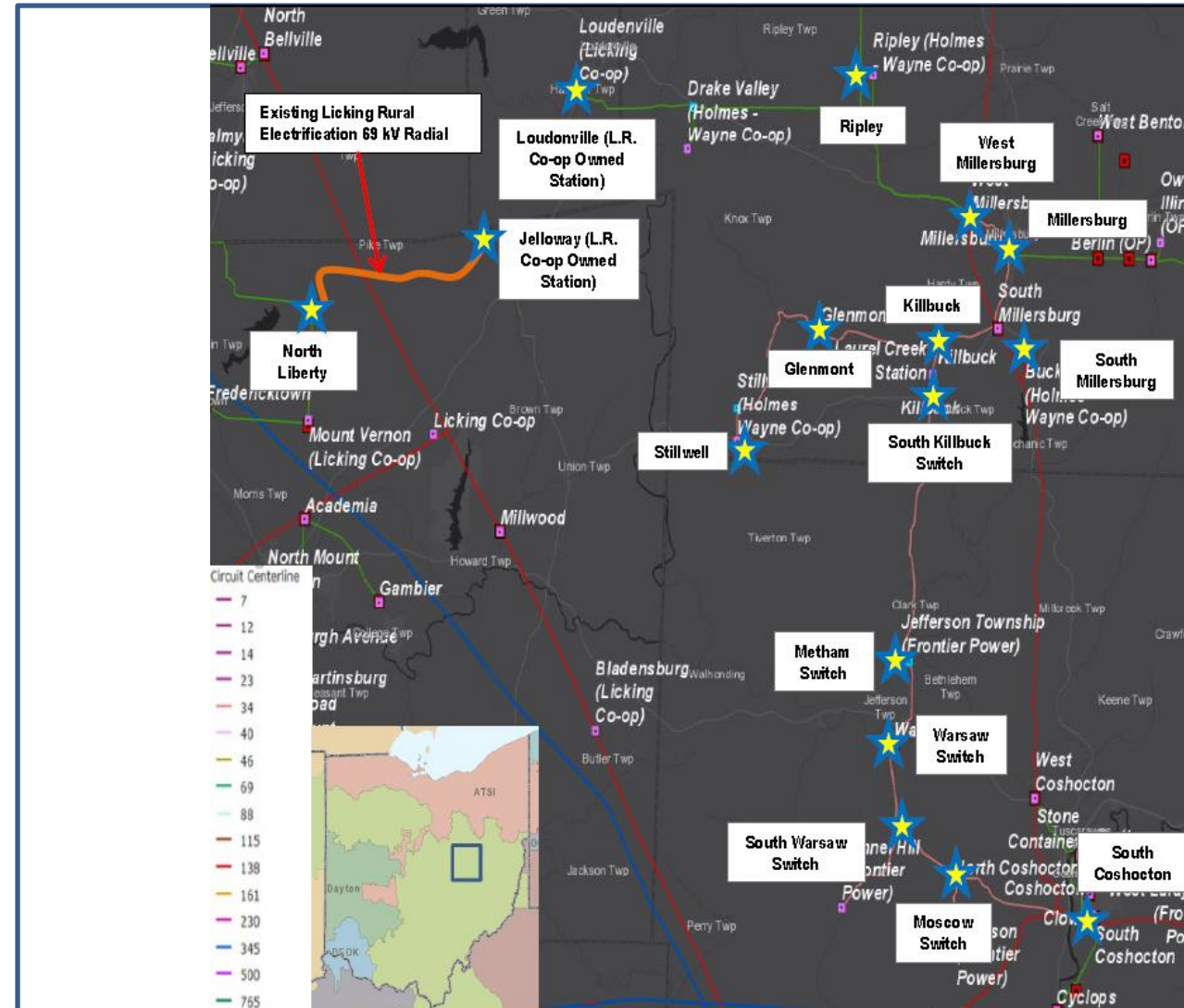

AEP Transmission Zone M-3 Process Coshocton Area Improvements

Need Number: AEP-2018-OH006

Process Stage: Submission of Supplemental Project for inclusion in the Local Plan 1/29/2020

Selected Solution:

All lines will be built 556.5 ACSR conductor unless stated otherwise.

Ravin: Cost \$8.6M

- Build a greenfield station at 69kV 2000A 40kA in a 3-breaker ring configuration next to Jelloway (L.R. Co-op). (S2149.1)

Jelloway Co-op –Ravin 69kV :Cost \$0.7M

- Build ~0.01 miles of greenfield 69kV line to connect Ravin to Jelloway Co-op. Under emergency conditions Jelloway can be fed radially from North Liberty Switch. North Liberty Switch will be normally open towards Jelloway Co-op. (S2149.2)

Stillwell Switch: Cost \$0.8M

- Install a greenfield 69kV 1200 A 3-way POP switch. (S2149.3)

Stillwell Switch –Ravin 69kV : Cost \$26.4M

- Build ~11.4 miles of greenfield 69 kV line. (S2149.4)

Hanover Switch: Cost: \$0.8M

- Install a greenfield 69kV 1200A 3-way POP switch (near existing Loudonville). (S2149.5)

Hanover Switch –Ravin 69kV : Cost \$12.9M

- Build ~5.17 miles of greenfield 69 kV line. (S2149.6)

Loudonville (L.R. Co-op) Station –Hanover Switch : Cost \$0.7M

- Reconnect the Loudonville (L.R. Co-op) Station to then new Hanover 69 kV Switch. (S2149.7)

Fort Fizzle (Replaces Glenmont Junction Sw): Cost \$1.1M

- Build a new greenfield 69 kV station in an in/out configuration with 1200A switches to replace Glenmont Junction Switch. Remove existing Glenmont station. (S2149.8)

Fort Fizzle –Stillwell 69kV : Cost \$16.7M

- Rebuild ~7.07 miles of the existing Glenmont Junction -Stillwell 34.5kV line at 69kV. (S2149.9)

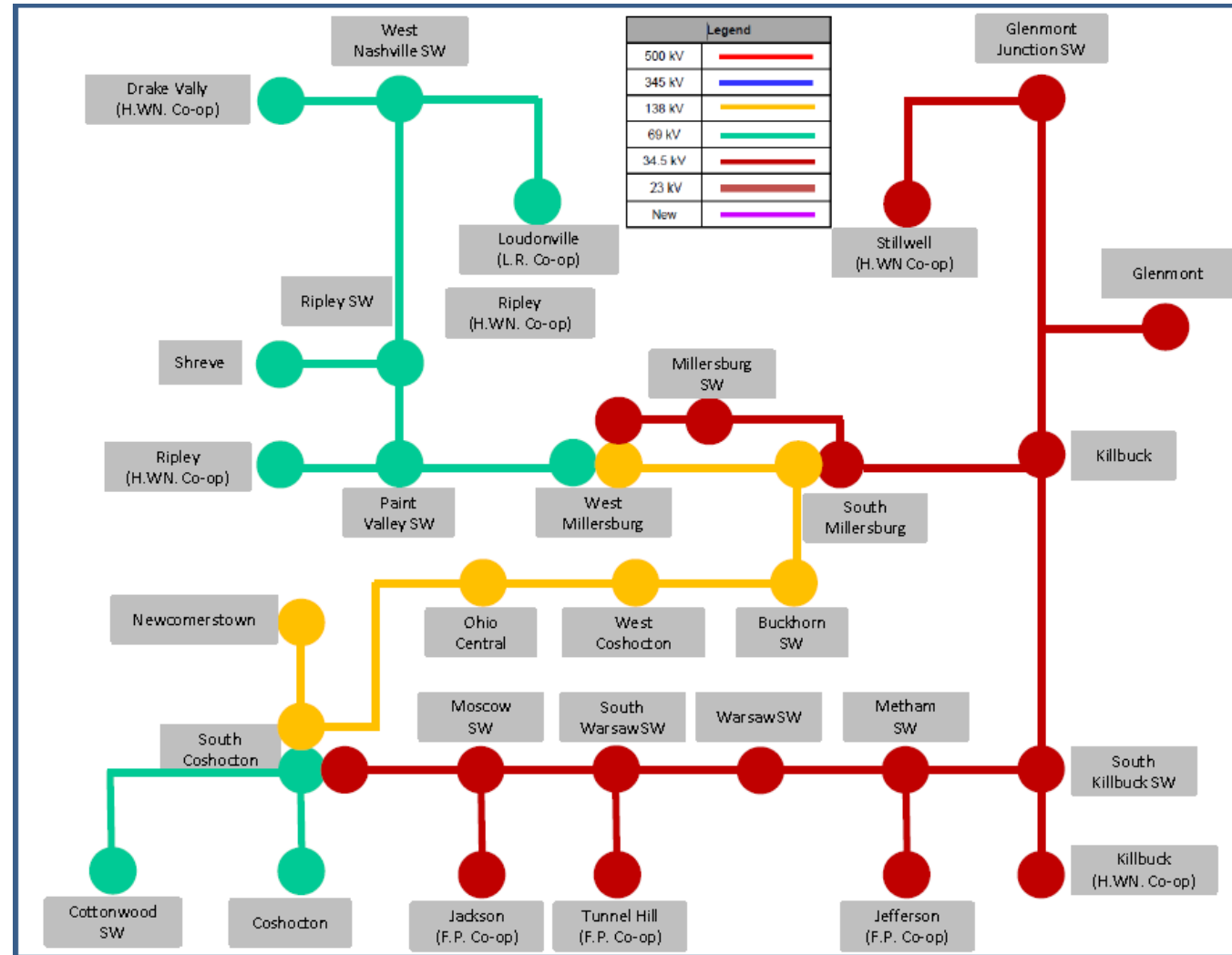

Existing

AEP Transmission Zone M-3 Process Coshocton Area Improvements

Potential Solution Continued:

Fort Fizzle –Killbuck 69kV: Cost \$12.9M

- Rebuild ~5.51 miles of the existing Killbuck to Glenmont (Fort Fizzle) 34.5kV line at 69kV. (S2149.10)

Black Diamond (Replaces South Millersburg): Cost \$10.2M

- Build a greenfield station at 138 kV 3000A 40kA in 4-breaker ring configuration. Replace the 138/34.5kV 25MVA transformer with a 138/69kV 90MVA transformer. Remove the 34.5kV circuit breaker “C” and install a new 69kV 2000A 40kA circuit breaker towards Killbuck. Remove the 34.5kV 3000A kVAR Cap bank “AA”. The Buckhorn (H.WN. Co-op) 138 kV delivery point will now connect to Black Diamond station. Remove South Millersburg station and Buckhorn switch. (S2149.11)

Black Diamond –Killbuck69kV: Cost: \$6.4M

- Rebuild ~4.12 miles of the existing South Millersburg (Black Diamond) to Killbuck69kV line. (S2149.12)

Black Diamond 138 kV Line Extension: Cost \$1.7M

- Build ~0.56 miles of greenfield 138kV line (556 ACSR) to connect Black Diamond 138 kV to the existing West Millersburg 138 kV line. (S2149.13)

Ohio Central –West Millersburg 138kV circuit: Cost \$0.7M

- Remove ~.9 miles of the Ohio Central –West Millersburg 138 kV circuit and reroute into Black Diamond station. (S2149.14)

Buckhorn (H.WN Co-op) –South Millersburg 138kV line: Cost \$2.0M

- Build a new 138 kV line (~.8 miles) to reconnect the existing Buckhorn (H.WN Coop) into Black Diamond 138 kV station. (S2149.15)

Millersburg: Cost \$2.8M

- Cut the Berlin –West Millersburg 69 kV line into Millersburg station with an in/out configuration with 1200 A line switches. (S2149.16)

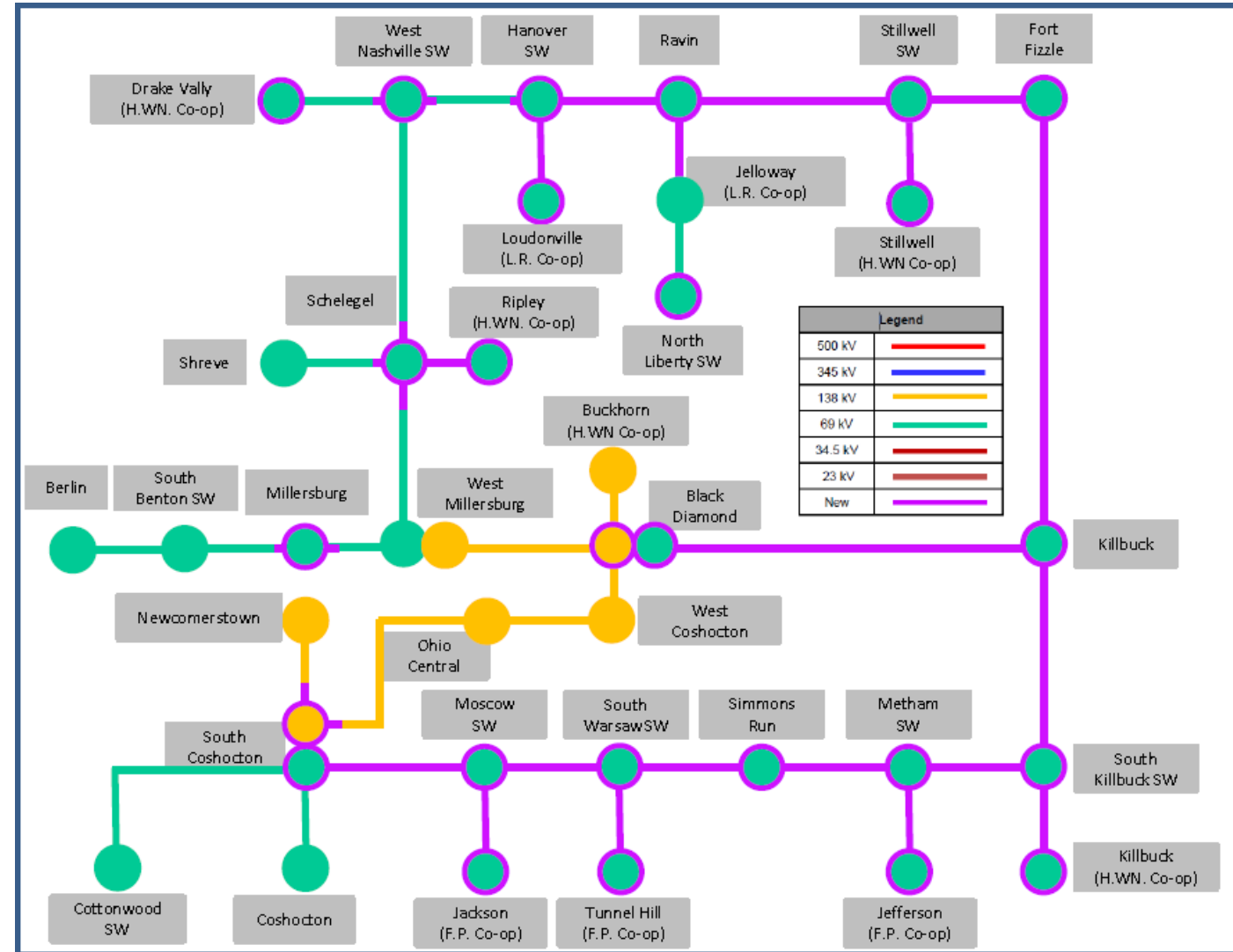

Proposed

AEP Transmission Zone M-3 Process Coshocton Area Improvements

Potential Solution Continued:

Schlegel (Replaces Ripley Switch): Cost \$9.5M

- Build a greenfield station at 69kV 40kA 2000A in a 4-breaker ring configuration next to Ripley (H.WN. Co-op)'s station. Remove the existing Ripley and Paint Valley switches and reconnect the lines into the new Schlegel station. (S2149.17)

Shreve –Schlegel 69kV: Cost \$0.6M

- Relocate the existing Shreve to Ripley 69kV line to Schlegel station. (S2149.18)

West Millersburg –Schlegel 69kV: Cost \$0.6M

- Relocate the existing West Millersburg to Paint Valley 69kV line to Schlegel station. (S2149.19)

West Nashville: Cost \$0.7M

- Install a 69kV 1200A 3-way POP switch (near existing Drake Valley (H.WN. Co-op)). (S2149.20)

Millersburg –West Millersburg 34kV: Cost \$0.1M

- Retire ~1.24 miles of the existing Millersburg to West Millersburg 34kV line. (S2149.21)

Millersburg -South Millersburg 34kV: Cost \$0.9M

- Retire ~2.93 miles of the existing Millersburg to South Millersburg 34kV line. (S2149.22)

South Killbuck Switch: Cost \$0.6M

- Replace 2-way POP with a 3-way 69kV 1200A POP switch. (S2149.23)

South Killbuck –Killbuck H.WN. Co-op 69kV: Cost \$0.7M

- Rebuild ~0.05 miles of the South Killbuck to Killbuck Holmes Wayne Co-op 34kV line to 69kV. (S2149.24)

Metham Switch: Cost \$0.6M

- Replace 2-way POP with a 3-way 69kV 1200A POP switch. (S2149.25)

Metham–Jefferson (F.P. Co-op) 69kV: Cost \$1.2M

- Rebuild ~0.38 miles of the Metham to Jefferson (F.P. Co-op) 34.5kV line to 69kV. (S2149.26)

Simmons Run –Killbuck 69kV: Cost \$31.1M

- Rebuild ~10.4 miles of the South Coshocton to Killbuck 34.5 kV line to 69kV. (S2149.27)

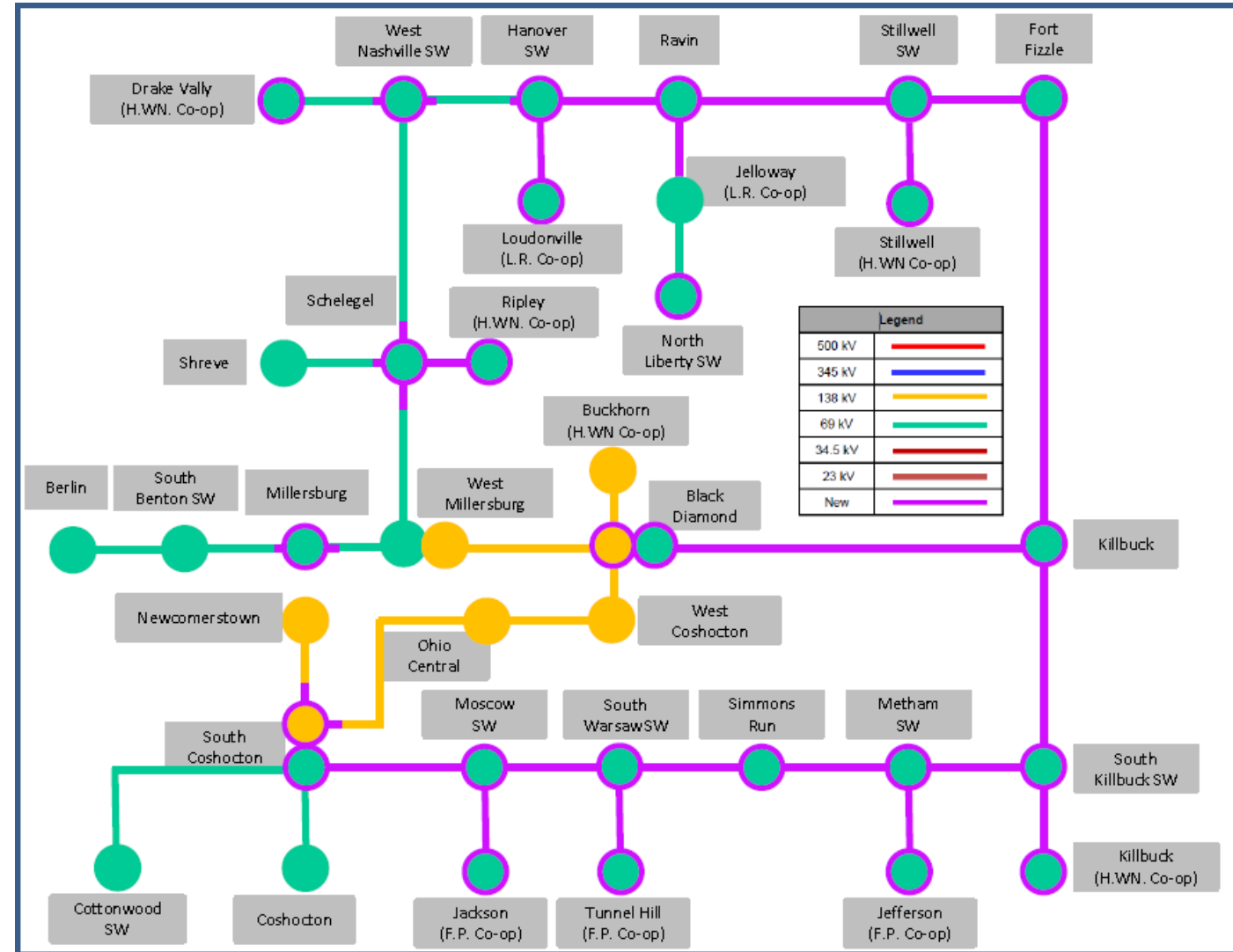

Proposed

AEP Transmission Zone M-3 Process Coshocton Area Improvements

Simmons Run (Replaces Warsaw Switch): Cost \$8.7M

- Build a greenfield station at 69 kV 2000A 40kA in 3-breaker ring configuration. Remove existing Warsaw switching. (\$2149.28)

South Warsaw –Tunnel Hill (F.P. Co-op) 69kV: Cost \$9.3M

- Rebuild ~3.73 miles of the existing South Warsaw to Tunnel Hill (F.P. Co-op) 34.5kV line to 69kV. (\$2149.29)

Moscow Switch: Cost \$0.6M

- Replace 2-way POP with a 3-way 69kV 1200A POP switch. (\$2149.30)

Moscow –Jackson (F.P Co-op) 69kV: Cost \$3.5M

- Rebuild ~1.24 miles of the existing Moscow to Jackson (F.P. Co-op) 34.5 kV line to 69kV. (\$2149.31)

South Coshocton -Simmons Run 69kV: Cost \$31.7M

- Rebuild ~14.4 miles of the existing South Coshocton to Killbuck 34kV line to 69 kV. (\$2149.32)

South Coshocton: Cost \$10.9M

- Build a 138 kV 3000 A 40 kA 5-breaker ring bus and install a 138/69 kV 130 MVA transformer. Install 3 new 69 kV 1200A 40 kA circuit breakers on the line towards Simmons Run, towards Coshocton, and on the low side of the transformer. Retire and remove the 138/69kV 75MVA transformer #2, as well as the 69/34.5kV 35MVA transformer #3. Leave the 138/34.5kV 30MVA transformer #1 to serve San Cast customer. (\$2149.33)

Ancillary Benefits: Holistic solution to a large area with multiple needs.

Estimated Cost: \$216.7M

Projected In-Service: August 2025

Supplemental Project ID: S2149.1-.33

Project Status: Scoping

Model: N/A

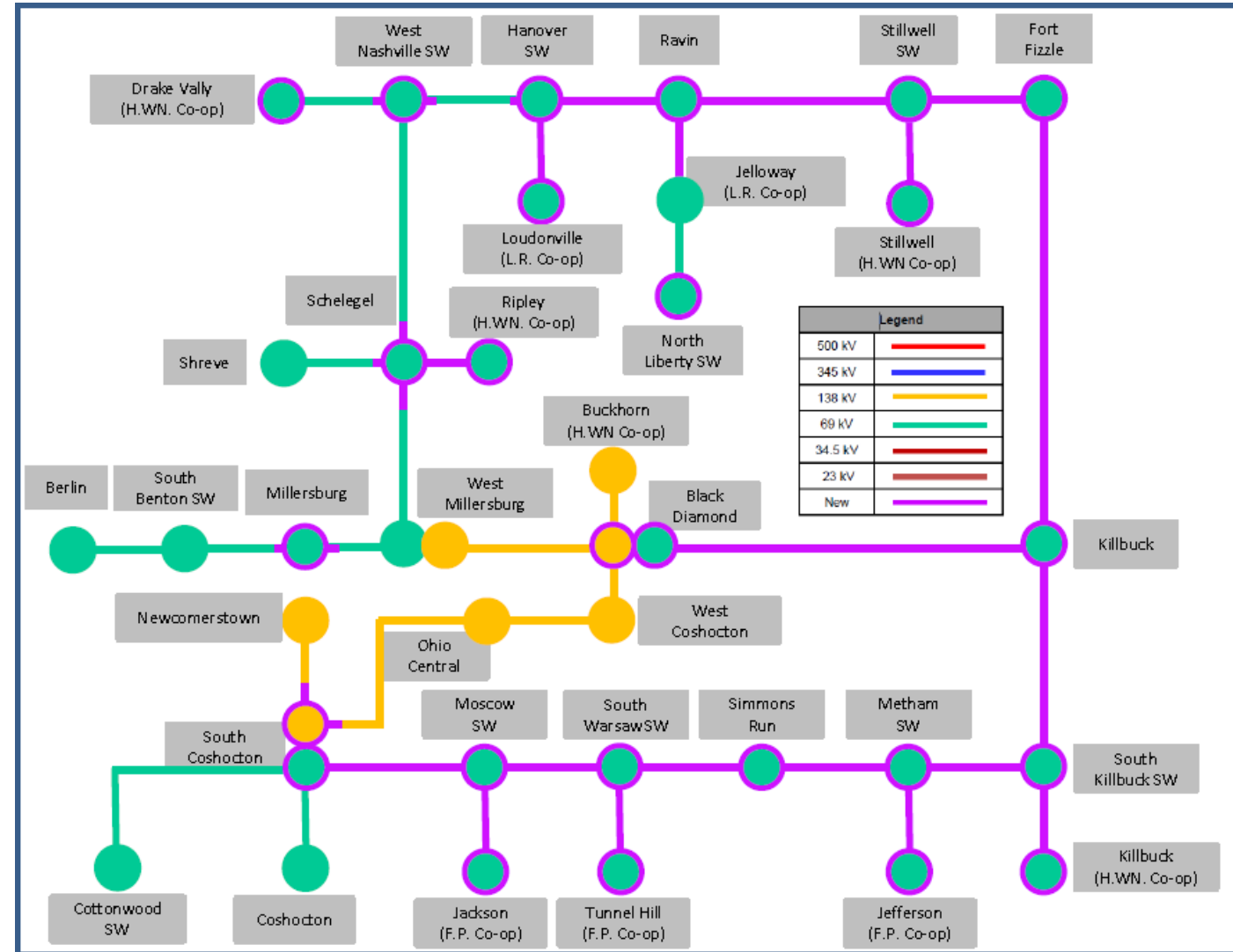

Proposed

AEP Transmission Zone M-3 Process Beartown – Moreland Line Rebuild

Need Number: AEP-2018-OH016

Process Stage: Submission of Supplemental Project for inclusion in the Local Plan 1/29/2020

Previously Presented:

Needs Meeting 10/25/2018

Solutions Meeting 11/22/2019

Project Driver:

Equipment Condition

Specific Assumption Reference:

AEP Guidelines for Owner Identified Needs (AEP Assumptions slide 8)

Problem Statement:

The Beartown-West Wilmont 69kV section is 10.5 miles long and serves 1 AEP Ohio distribution station and 1 Holmes-Wayne Co-op station in northeast Ohio. Over the past several years, the circuit has experienced below-average reliability. For the 2017-2018 YTD period, it has experienced 7 sustained outages, an additional 8 momentary interruptions, and 2 emergency repair incidents on the entire circuit. The majority of the outages were due to T-Line structural issues and forestry. The line section consists of primarily 336 ACSR (1962-64 vintage); it is entirely wood pole construction, with the majority being installed in the 1960's. The section has a reported CMI of 2.0M between 2014 – 2018 and currently has 52 open conditions (25 Category A, 25 Category B, 5 Forestry). Examples of the conditions include: rotted poles, missing ground-leads, and damaged conductor. During the 2010-2018 period, 112 prior conditions were repaired/addressed on the circuit as a whole.

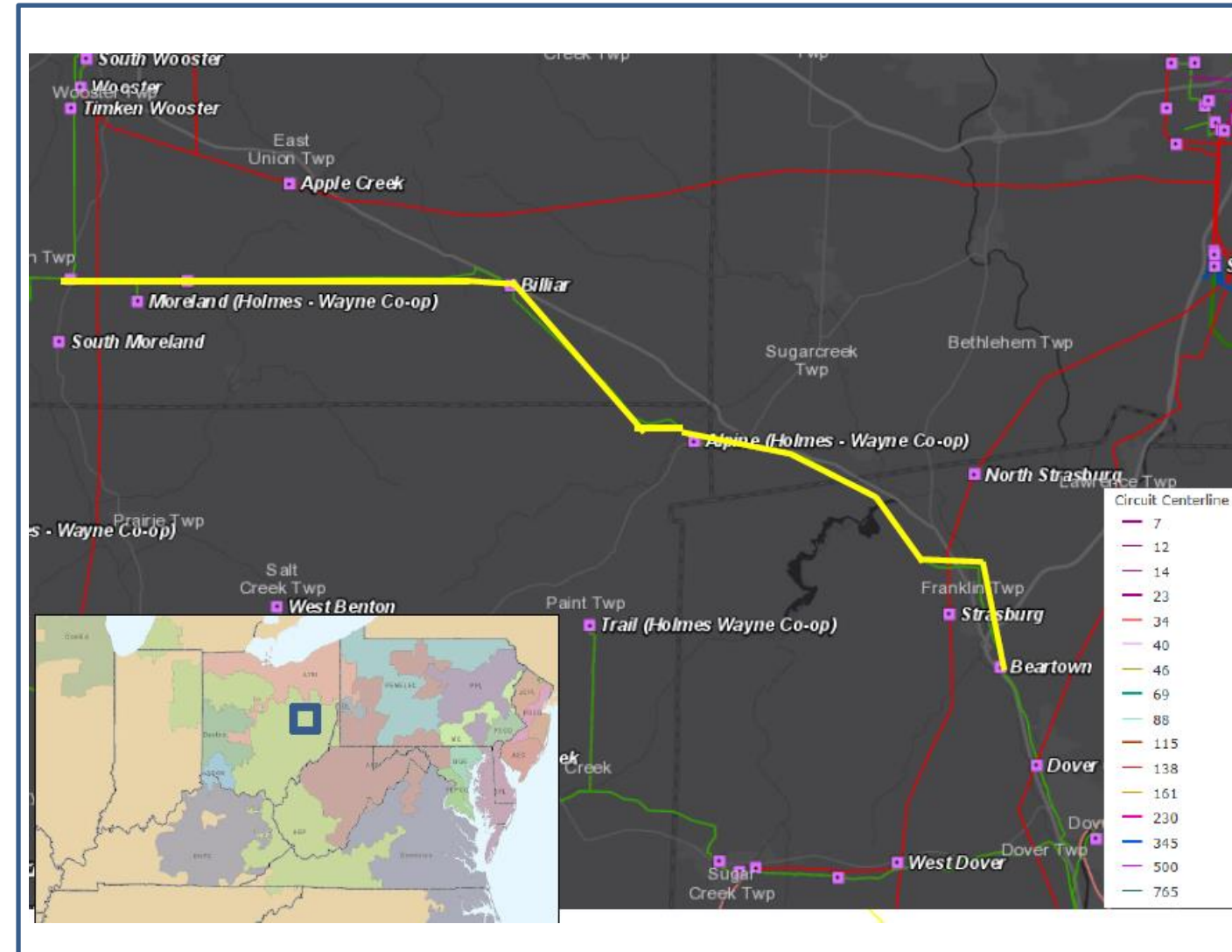

AEP Transmission Zone M-3 Process Beartown – Moreland Line Rebuild

Need Number: AEP-2018-OH016

Process Stage: Submission of Supplemental Project for inclusion in the Local Plan 1/29/2020

Selected Solution:

Rebuild the existing Beartown-Moreland 69kV Transmission line between Beartown and West Wilmot Junction Switch (approx. 10.6 miles) using 556 ACSR. **(S2140)**

Estimated Cost: \$22.6M

Projected In-Service: 12/1/2021

Supplemental Project ID: S2140

Project Status: Scoping

Model: Summer 2023 RTEP

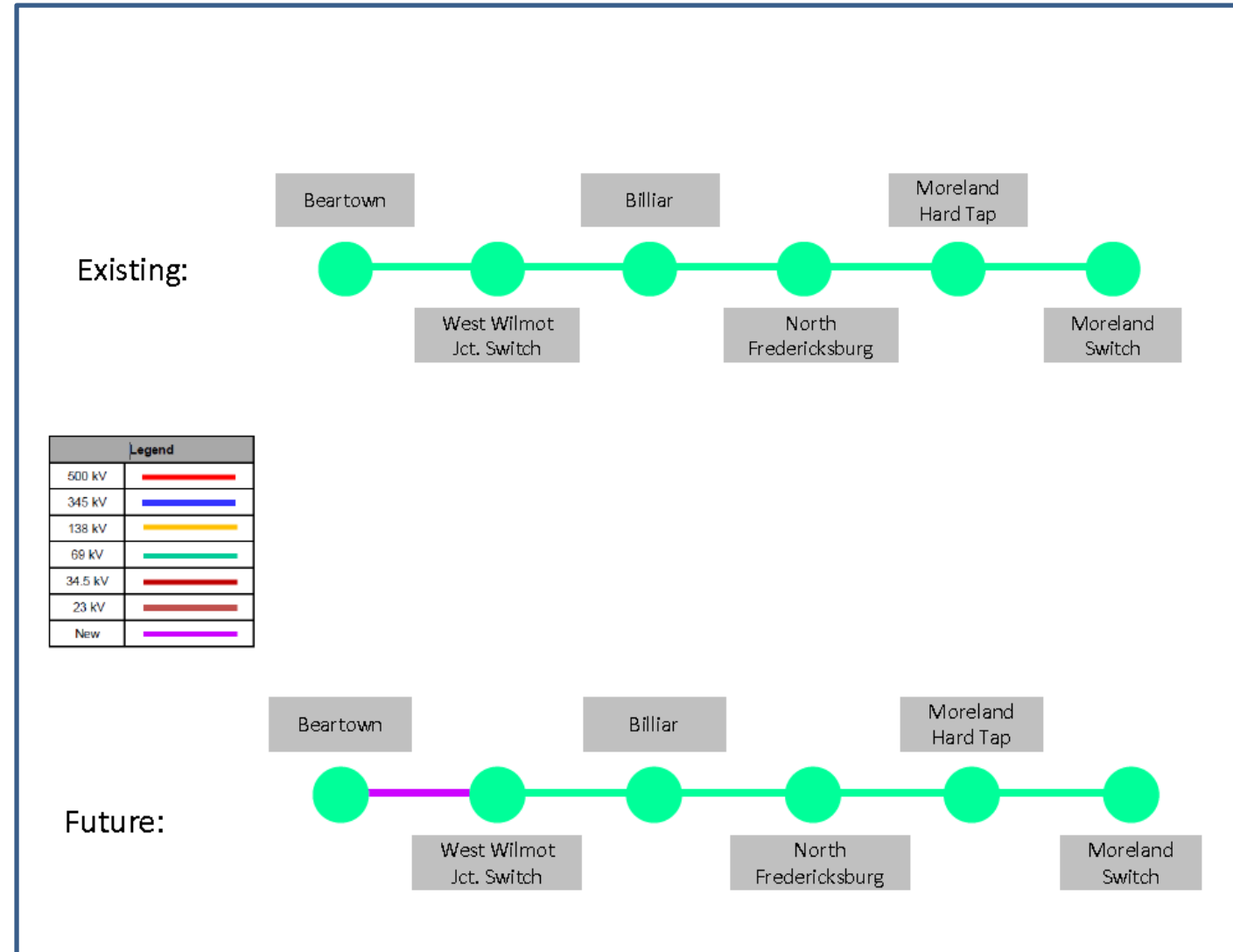

AEP Transmission Zone M-3 Process

Robyville – Glencoe 69kV

Need Number: AEP-2019-OH019

Process Stage: Submission of Supplemental Project for inclusion in the Local Plan 1/29/2020

Previously Presented:

Needs Meeting 4/23/2019

Solutions Meeting 11/22/2019

Project Driver:

Equipment Material/Condition/Performance/Risk

Specific Assumption Reference:

AEP Guidelines for Transmission Owner Identified Needs

Problem Statement:

- The Glencoe – Robyville 69kV circuit section of concern is 12.9 miles long and originally constructed in 1915-1925 using wood pole structures. This circuit currently has 556 ACSR 18/1 (Osprey) conductor.
 - The non-standard conductor is single-strand steel core which significantly diminishes conductor strength over time as there is only a single steel strand supporting the aluminum wire.
- The Glencoe – Robyville 69kV circuit has 136 open A conditions which include broken shield/ground wires, heavy structure rot, woodpecker damage, broken insulators, and split cross arms/knee braces.
- This circuit has experienced 789,612 customer-minutes-of-interruption (CMI) between 2013 – 2018.
- The existing switch at Highland Terrace is a two-way wood-pole switch installed in 1979 that restricts our ability to perform routine maintenance and restoration activities in this remote area of our system (compared to a standard three-way switch at a tap point).
- The Shepherdstown Co-op 69kV delivery point is connected via a hard tap (no line switches) which limits operational flexibility and restricts restoration activities, as the customer must take an outage when transmission line maintenance must be performed.

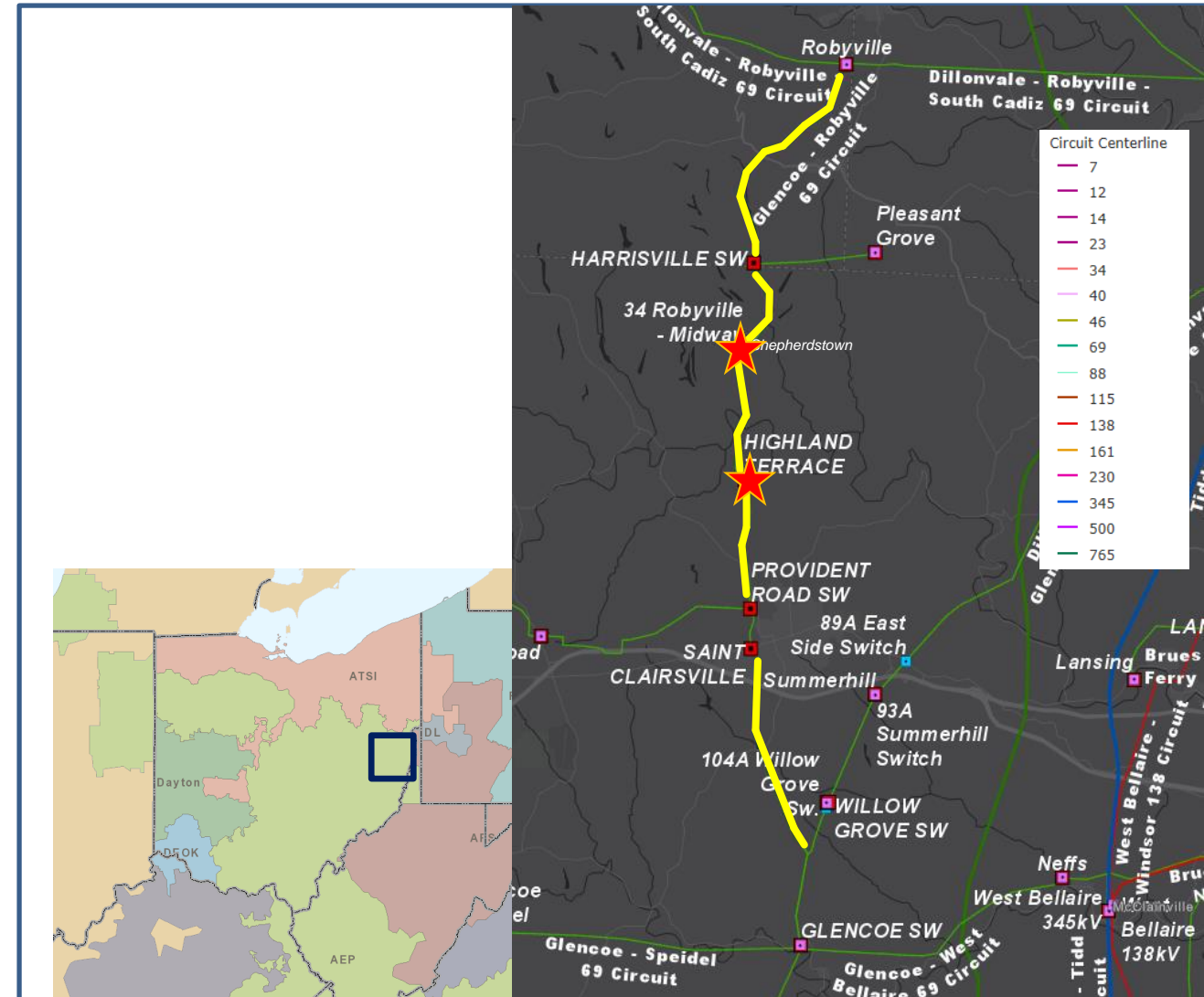

AEP Transmission Zone M-3 Process Robyville – Glencoe 69kV

Need Number: AEP-2019-OH019

Process Stage: Submission of Supplemental Project for inclusion in the Local Plan 1/29/2020

Selected Solution:

Rebuild the remainder of the Glencoe-Robyville 69kV circuit (12.9 miles) utilizing 795 kcmil ACSR conductor. **(S2147.1)**

Estimated Cost: \$27.5 M

At Shepherdstown, install a three-way 1200A, 69kV switch. **(S2147.2) Estimated Cost: \$0.8 M**

At Highland Terrace, install a three-way 1200A, 69kV switch. **(S2147.3) Estimated Cost: \$0.7 M**

Total Estimated Transmission Cost: \$29.0M

Projected In-Service: 12/31/2022

Supplemental Project ID: S2147.1-.3

Project Status: Scoping

Model: N/A

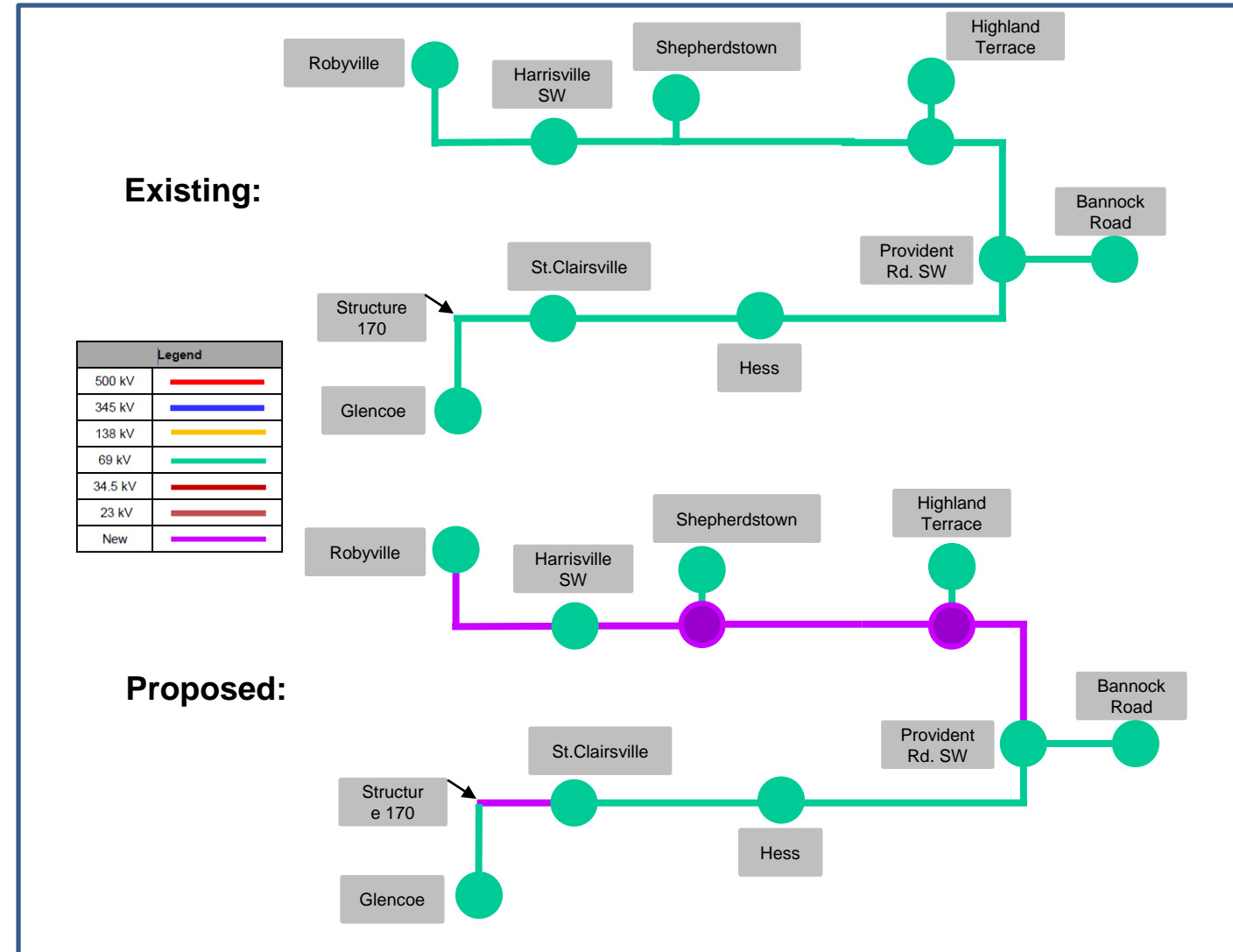

AEP Transmission Zone M-3 Process South Canton Breakers

Need Number: AEP-2019-OH055

Process Stage: Submission of Supplemental Project for inclusion in the Local Plan 1/29/2020

Previously Presented:

Needs Meeting 10/25/2019

Solutions Meeting 11/22/2019

Project Driver:

Equipment Material/Condition/ Performance/Risk

Specific Assumption Reference:

AEP Connection Requirements for the AEP Transmission System (AEP Assumptions Slide 7)

Problem Statement:

138kV Circuit Breakers: K1, L1, & M1

- Interrupting Medium: SF6
- Additional Info: In addition to the 12 - 138kV overdutied breakers at South Canton, these remaining 3 breakers have fault duty in the 95-99% range.

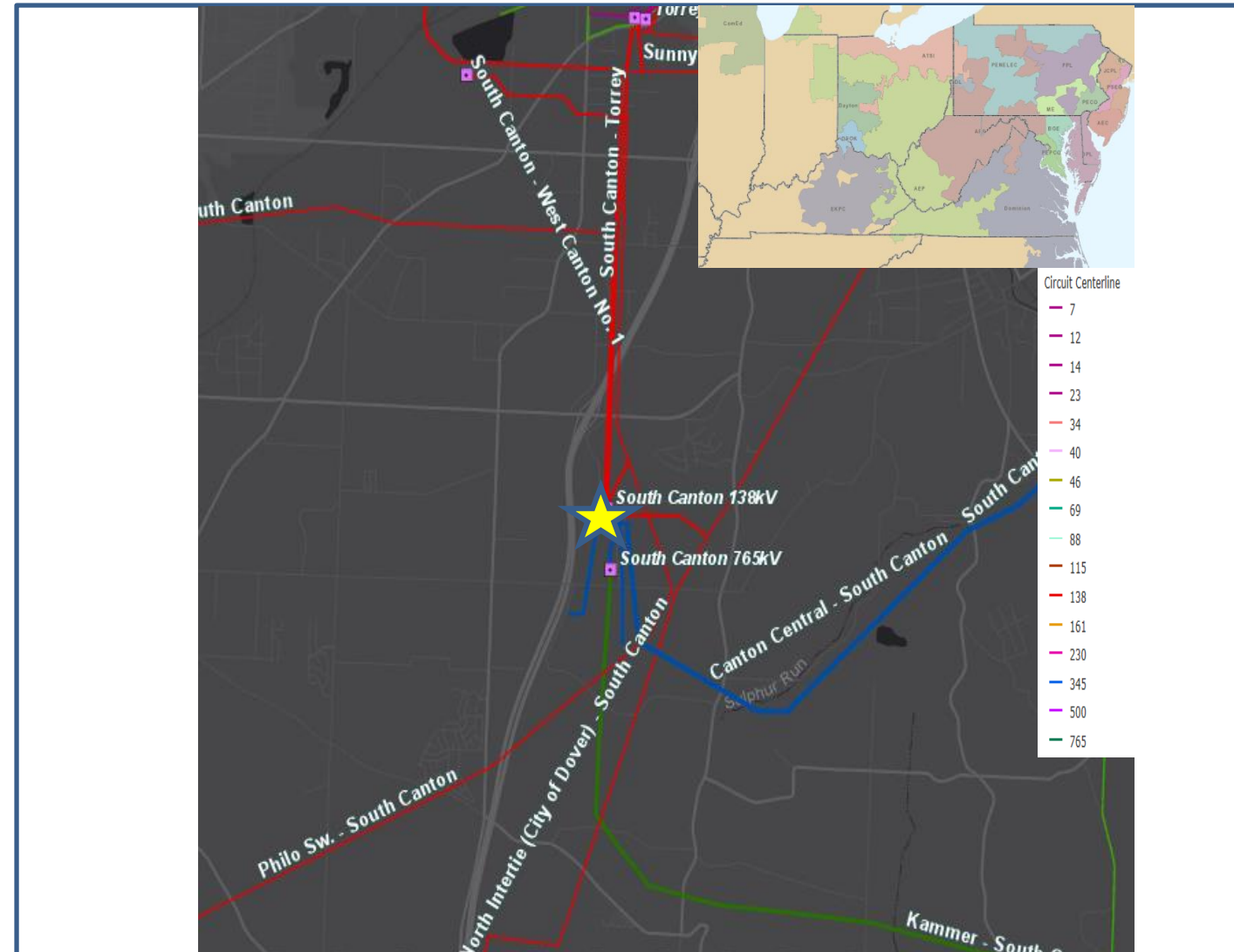

Need Number: AEP-2019-OH055

Process Stage: Submission of Supplemental Project for inclusion in the Local Plan 1/29/2020

Selected Solution:

Replace 138kV breakers K1, L1, & M1 (3000A, 63kA) with new units (3000A, 80kA). Note that the 3 existing breakers are in usable condition and will be stored as system spares and reused. **(S2148)**

Ancillary Benefits: Ensures safety to field personnel, should area transmission system fault levels rise.

Estimated Cost: \$2.5M

Projected In-Service: 12/1/2021

Supplemental Project ID: S2148

Project Status: Scoping

Model: Summer 2019 RTEP Short Circuit

Bubble Diagram Not Applicable

AEP Transmission Zone M-3 Process South Lynchburg

Need Number: AEP-2019-AP003

Process Stage: Submission of Supplemental Project for inclusion in the Local Plan 1/29/2020

Previously Presented:

Needs Meeting 2/20/2019

Solutions Meeting 11/22/2019

Project Driver:

Equipment Material/Condition/Performance/Risk

Specific Assumption Reference:

AEP Guidelines for Transmission Owner Identified Needs (AEP Assumptions Slide 8)

Problem Statement:

- The 1959 vintage 138/69/34.5 kV transformer #1 at South Lynchburg Substation has elevated levels of carbon dioxide which began increasing in 2004. Additionally, the interfacial tension is steadily decreasing and the oil power factor is steadily increasing indicating that the oil insulation is beginning to degrade as well. This data proves that the transformers insulation is aged and has degraded.
- The 34.5 kV Grounding Bank was manufactured in 1954 and has high concentrations of combustible gases, specifically CO and CH4, due to various thermal faults and electrical discharges. Short circuit breakdown caused by the amount of through fault events, some greater than 700 degrees Celcius has contributed to the deterioration of the bank.
- 12 kV CBs P, L, K, N, M, and R are oil breakers
- Number of fault operations: P (44), L (42), K (152), N (132), M (34), R (135)
- 34.5 kV CB F has 31 fault operations
- 34.5 kV CB G has 63 fault operations

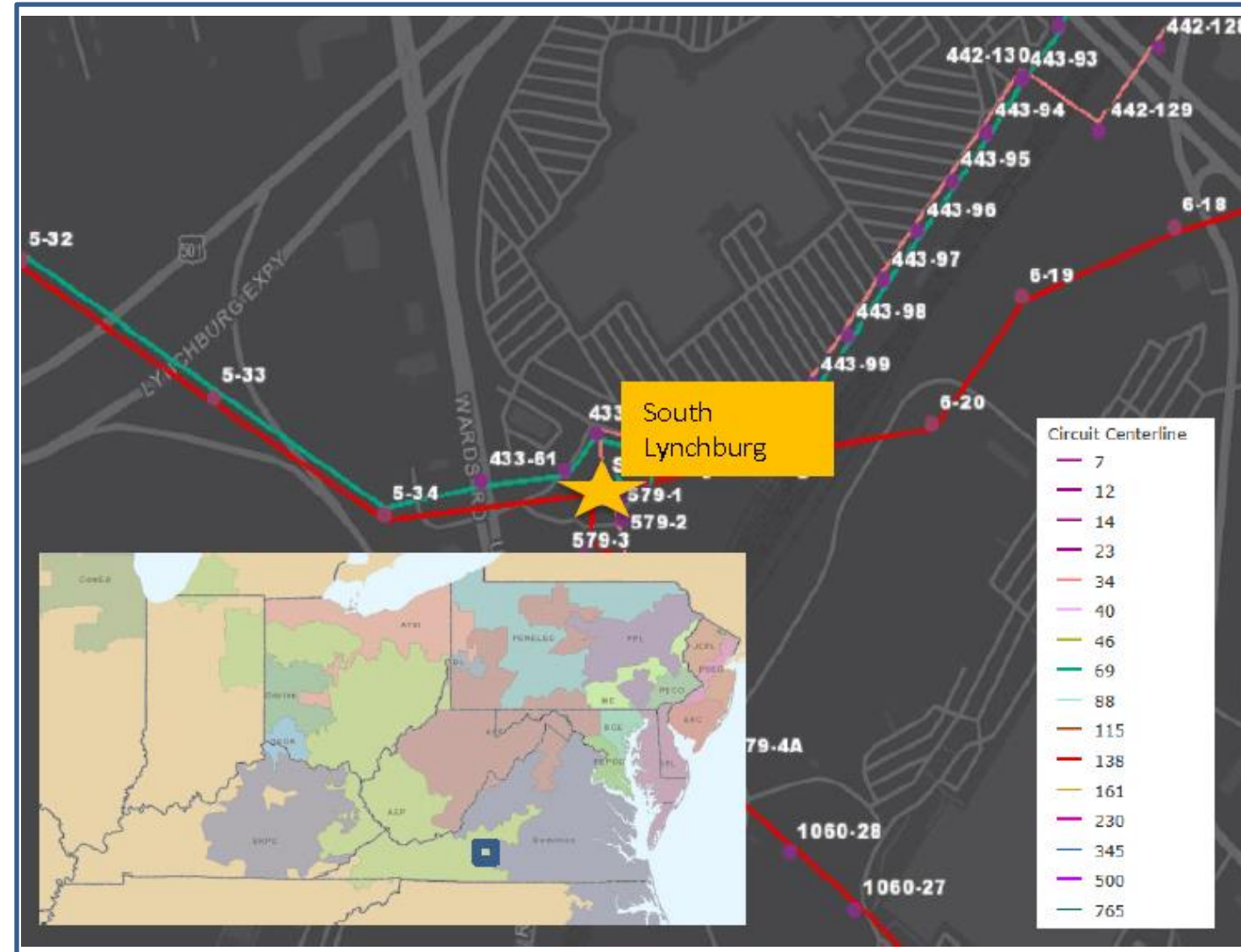

Need Number: AEP-2019-AP003

Process Stage: Submission of Supplemental Project for inclusion in the Local Plan 1/29/2020

Selected Solution:

At South Lynchburg station, replace existing 138/69/34.5 kV transformer #1 with a new 138/69/34.5 kV, 130 MVA bank and install associated protection. Replace the grounding bank. Replace 12kV CB's P, L, K, N, M and R with new 1200A 25KA CB's and install associated relays. Replace 34.5kV CB G and F with new 3000A 40kA CB. Install 69 kV CB between T1 secondary and 69 kV bus. **(S2141.1) Estimated Cost: \$5.7M**

Line work to relocate the 69 kV and 34.5 kV line entrances due to the larger physical size of the new transformer. **(S2141.2) Estimated Cost: \$1M**

Ancillary Benefits: Additional transformer capacity prevents future thermal overloads caused by the loss of Peakview and East Lynchburg 138/69 kV transformers. Future loadings exceed 85% for the existing transformer at South Lynchburg.

Estimated Cost: \$6.7M

Projected In-Service: 7/1/2021

Supplemental Project ID: S2141.1-2

Project Status: Engineering

Model: 2024 RTEP

No bubble diagram required.
Station work only.

AEP Transmission Zone M-3 Process Ironto Station (Service to CBEC)

Need Number: AEP-2019-AP006

Process Stage: Submission of Supplemental Project for inclusion in the Local Plan 1/29/2020

Previously Presented:

Needs Meeting 3/25/2019

Solutions Meeting 11/22/2019

Project Driver:

Customer Service

Specific Assumption Reference:

AEP Connection Requirements for the AEP Transmission System (AEP Assumptions Slide 7)

Problem Statement:

Craig-Botetourt Electric Cooperative (CBEC) requested a new delivery point from AEP to be located in Montgomery County, Virginia. The new station will serve approximately 10 MVA.

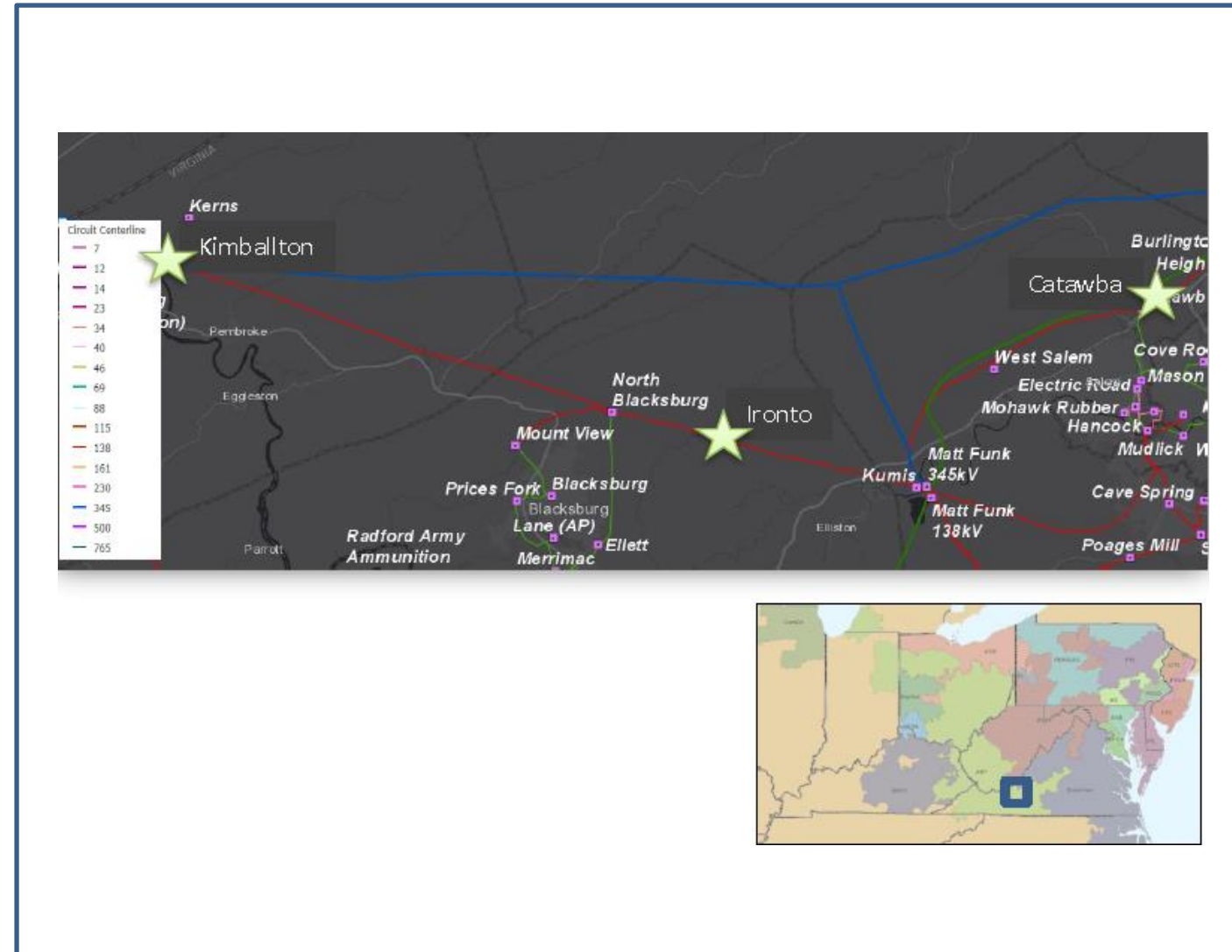

AEP Transmission Zone M-3 Process Ironto Station (Service to CBEC)

Need Number: AEP-2019-AP006

Process Stage: Submission of Supplemental Project for inclusion in the Local Plan 1/29/2020

Selected Solution:

Establish a new Ironto 138 kV delivery point by tapping the Catawba-Kimballton 138 kV circuit, installing 2-138 kV MOABs, associated controls, and 138 kV metering in customer's station. **(S2142)**

Estimated Cost: \$2.6M

Projected In-Service: 4/13/2020

Supplemental Project ID: S2142

Project Status: Engineering

Model: 2024 RTEP

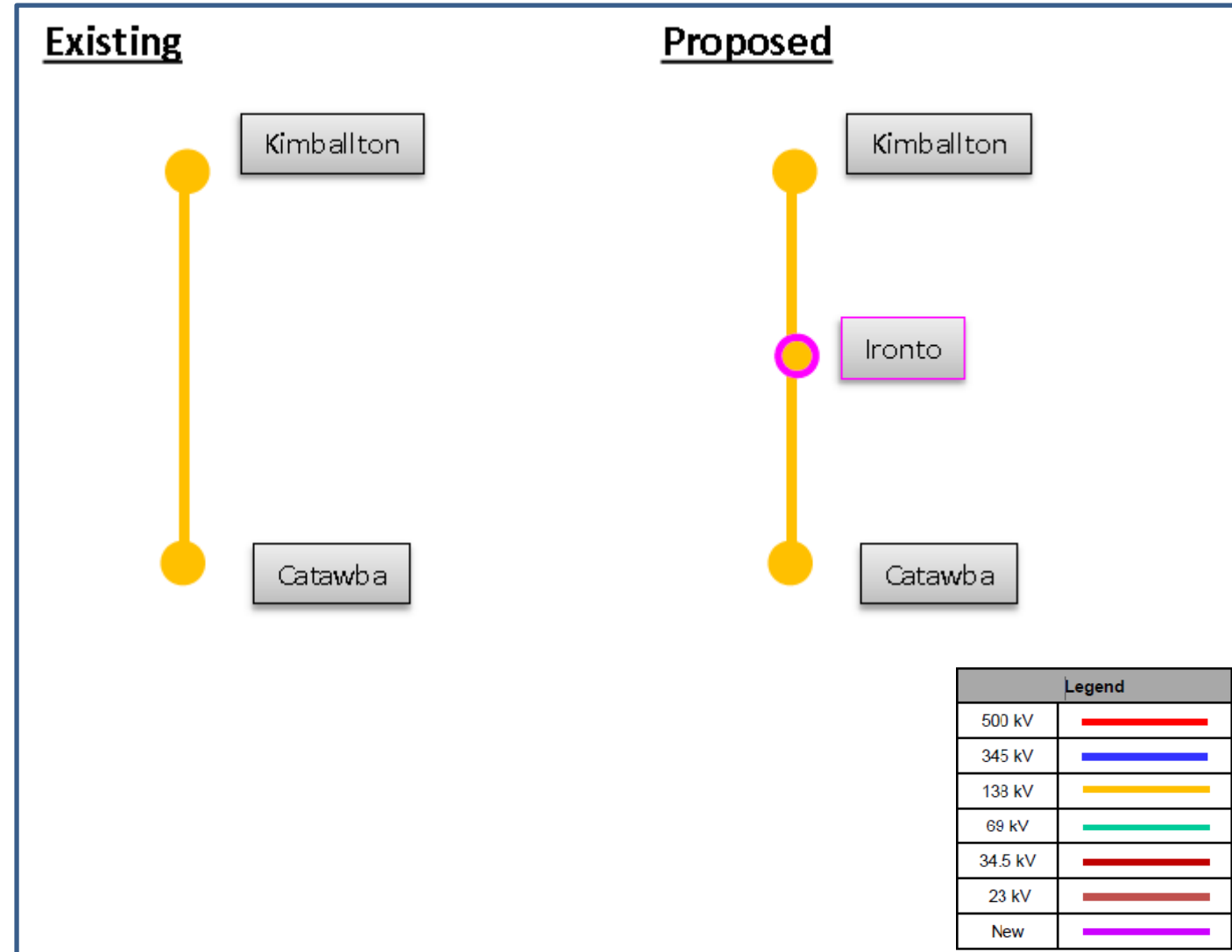

AEP Transmission Zone M-3 Process Danville Area

Need Number: AEP-2019-AP012

Process Stage: Submission of Supplemental Project for inclusion in the Local Plan 1/29/2020

Previously Presented:

Needs Meeting 5/20/2019

Solutions Meeting 11/22/2019

Project Driver:

Equipment Material/Condition/Performance/Risk

Specific Assumption Reference:

AEP Guidelines for Transmission Owner Identified Needs (AEP Assumptions Slide 8)

Problem Statement:

Several documented mis-operations have occurred related to defective and disabled pilot wire relaying between Danville, East Danville and the local 69 kV network. Pilot wire maintenance is a known safety concern especially during poor weather conditions throughout the Transmission organization. Elimination of pilot wire in the Danville area will address ground splice concerns reported by TFS management, pilot wire cabinet access issues and low hanging pilot wire on poles. Corrective maintenance continues to be a concern due to the lack of spare relay components and it being an obsolete technology. Due to the abnormal conditions and overall age of the pilot wire in the Danville area, mis-operations have continued to impact several large industrial customers exceeding a total of 15 MW.

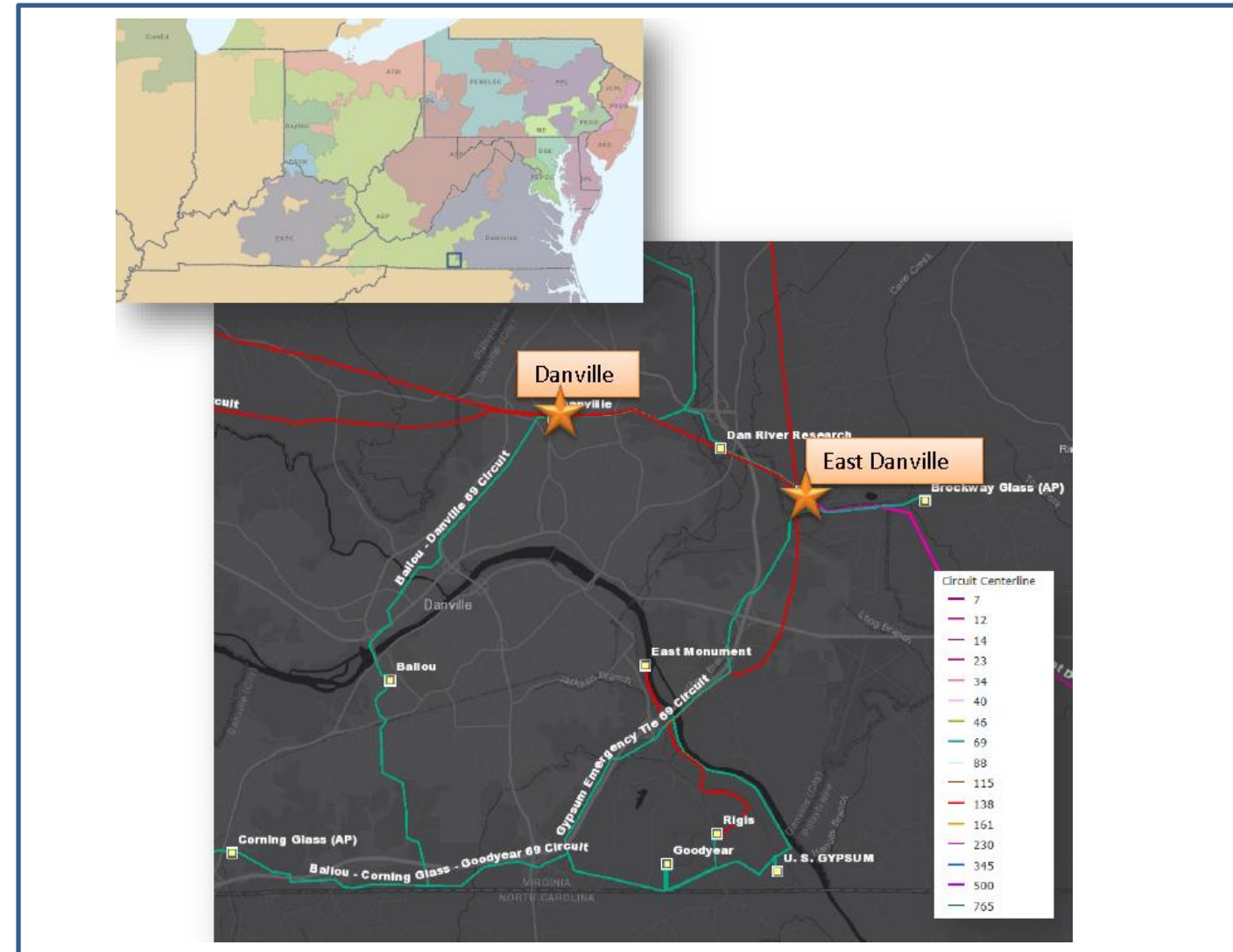

AEP Transmission Zone M-3 Process Danville Area

Continued from previous slide...

Problem Statement:

East Danville Station

- 138 kV Circuit Breakers L and M
 - 12 malfunction records indicating low SF6 gas during cold weather conditions with continued maintenance required
 - Have experienced 19 and 49 fault operations respectively. The manufacturer's recommendation for this type of breaker is 10.
- 138 kV Circuit Breaker P
 - CB P is FK type oil breaker (1955 vintage)
 - Oil breakers that are difficult to maintain due to the required oil handling. There is an increased potential for oil spills during routine maintenance and failures with these types of breakers.
- 69 kV Circuit Breakers F and H
 - FK type oil breakers (1965 vintage)
 - Malfunction on CB H for an air leak on the control valve
 - Have experienced 46 and 78 fault operations respectively. The manufacturer's recommendation for this type of breaker is 10.
- 69/12 kV T#3
 - High side MOAB Ground Switch
 - Tapped off of East Danville-US Gypsum 69 kV line, not currently tapped off bus

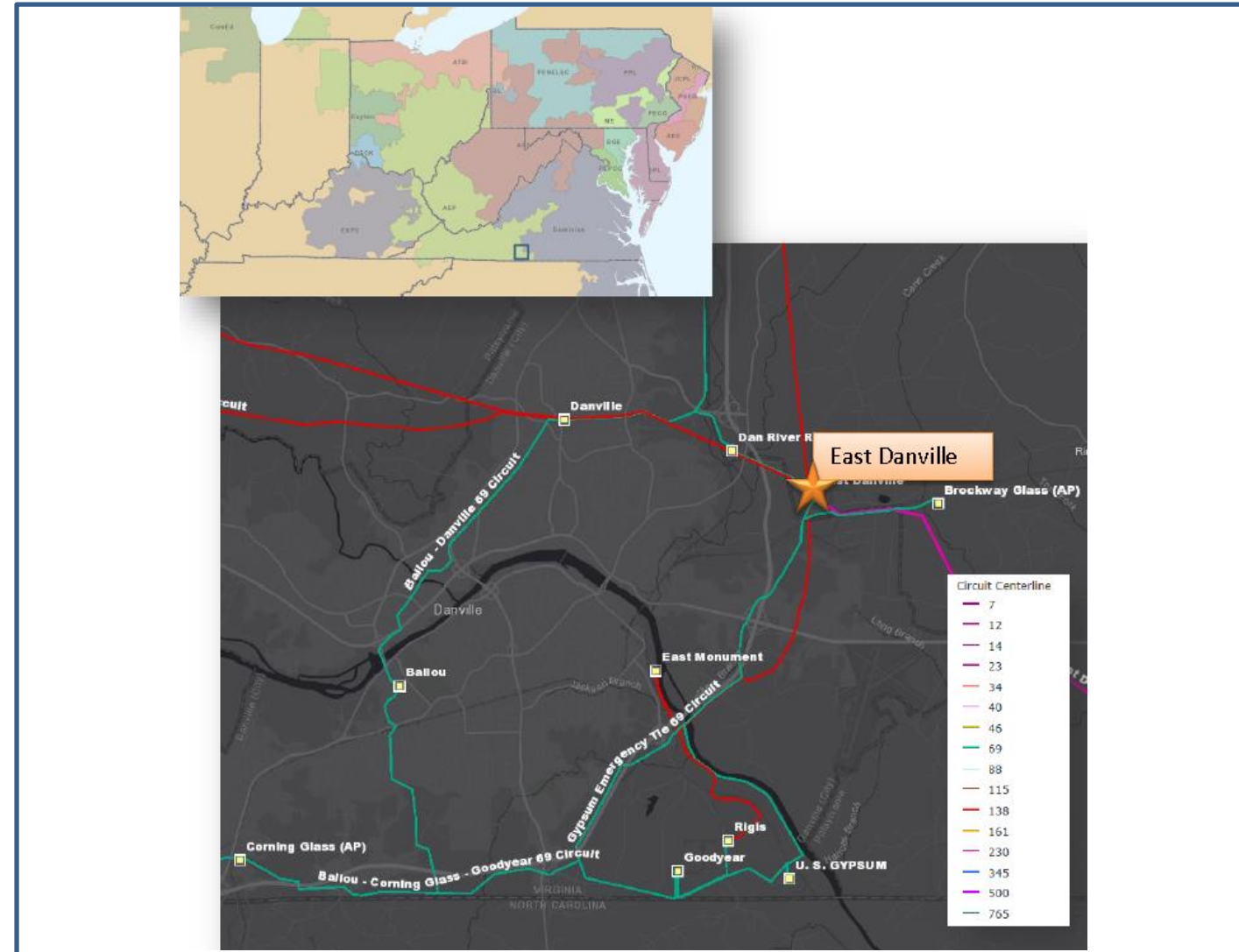

AEP Transmission Zone M-3 Process Danville Area

Continued from previous slide...

Problem Statement:

Goodyear Station

- 69 kV Circuit Breakers A, C and D
 - FK type oil breakers (1959, 1973 and 1972 vintage respectively)
 - Oil breakers that are difficult to maintain due to the required oil handling. There is an increased potential for oil spills during routine maintenance and failures with these types of breakers.
 - Have experienced 18, 9 and 7 fault operations respectively. The manufacturer's recommendation for this type of breaker is 10.
- Customer metering CTs and PTs are over 50 years old and accuracy class below recommended

US Gypsum Station

- Customer metering CTs and PTs are over 50 years old and accuracy class below recommended

Rigis Station

- 138/69 kV T#1
 - High side MOAB ground switch protection

Corning Glass Station

- 69 kV Circuit Breaker B
 - FK type oil breaker (1966 vintage); experienced 80 fault operations
- Circuit Switchers A and AA
 - S&C 2030-69, no gas monitor, model family has numerous documented malfunction records concerning gas loss and interrupter failures

US Gypsum Station

- 69 kV Circuit Breaker A
 - FK type oil breaker (1966 vintage); experienced 21 fault operations

Danville Station

- 69 kV Circuit Breaker J
 - FK type oil breaker (1966 vintage)

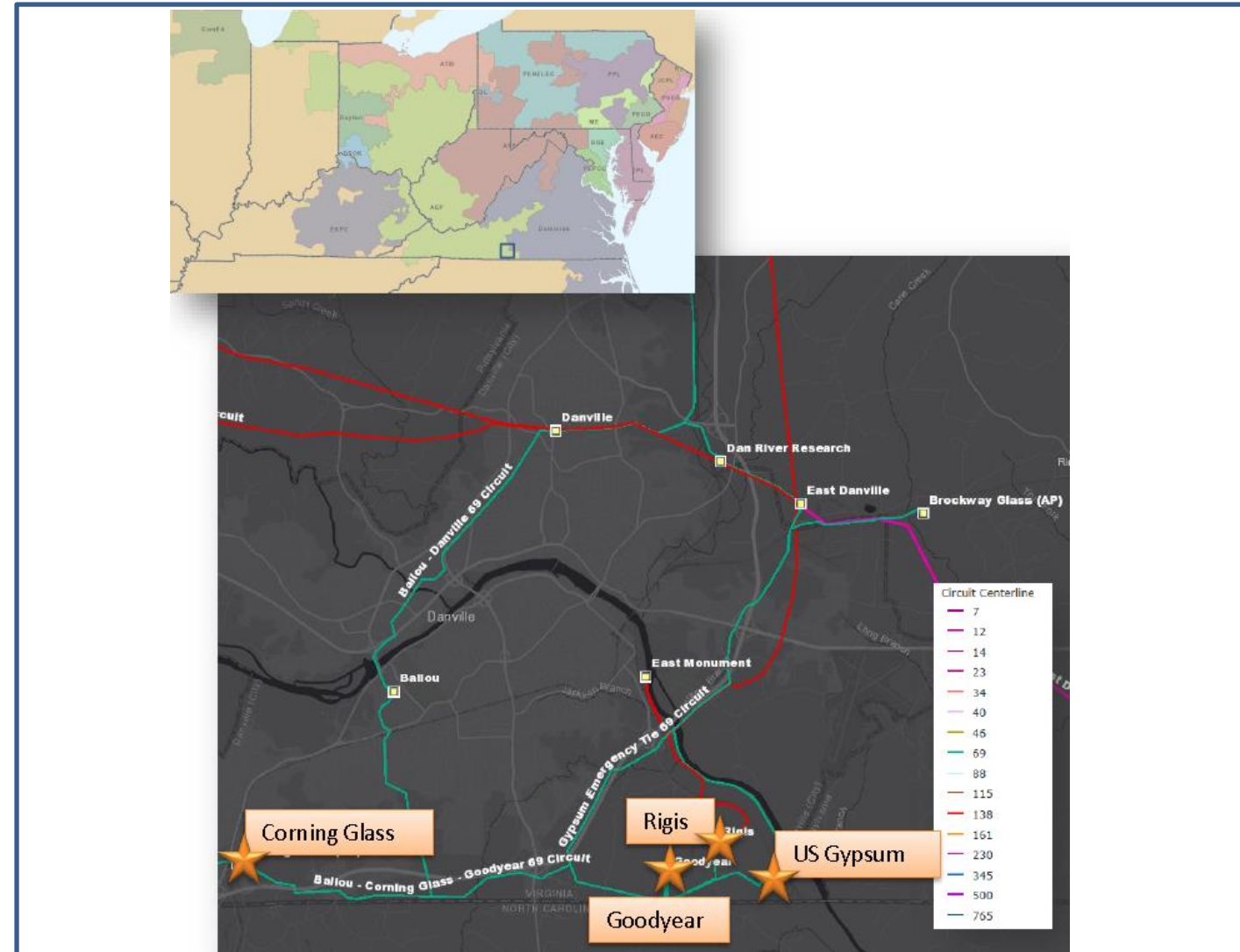

AEP Transmission Zone M-3 Process Danville Area

Need Number: AEP-2019-AP012

Process Stage: Submission of Supplemental Project for inclusion in the Local Plan 1/29/2020

Selected Solution:

At Danville station, install new 138 kV line relaying and CCVT's/foundations/stands on the East Danville line. Replace 69 kV Bus CCVT's and install required fiber and retire all pilot wire. Replace 69 kV breaker J with a 3000 A, 40 kA breaker. **(S2143.1) Estimated Cost: \$2.3M**

At East Danville station, replace 138 kV circuit breakers L, M, and P and associated disconnect switches with 3000 A, 40 kA breakers and 3000 A disconnect switches. Install 69 kV circuit breaker on low-side of T1. Replace 69 kV breakers F, H and associated disconnect switches with 3000 A, 40 kA breakers and 2000 A switches. Install new 138 kV line relaying and CCVT's/foundations/stands on the Danville line. Install new 69kV line relaying and CCVT's/foundations/stands on both the Danville line and U.S. Gypsum lines. Replace MOAB ground switch on T#3 with circuit switcher and relocate T#3 connection from US Gypsum line to 69 kV bus. Install required fiber and retire all pilot wire. **(S2143.2) Estimated Cost: \$7.2M**

At Rigis station, install new 69 kV line relaying and CCVT's/foundations/stands on the Goodyear line. Install required fiber and retire all pilot wire. Replace MOAB ground switch with circuit breaker on high-side of T#1. **(S2143.3) Estimated Cost: \$1.4M**

At Goodyear station, install new 69 kV line relaying and CCVT's on the Rigis line, U.S. Gypsum line and Corning Glass line. Install required fiber and retire all pilot wire associated with 69 kV US Gypsum, Rigis and Corning Glass circuits. Replace 69 kV breakers A, C and D and associated disconnect switches with 3000 A, 40 kA breakers and 2000 A disconnect switches. Upgrade existing 2-element customer metering at each of the feeds to the customer (3 total). **(S2143.4) Estimated Cost: \$4.4M**

At Ballou station, retire in-line equipment and retire transformer in-place. **(S2143.5) Estimated Cost: \$0M (Distribution)**

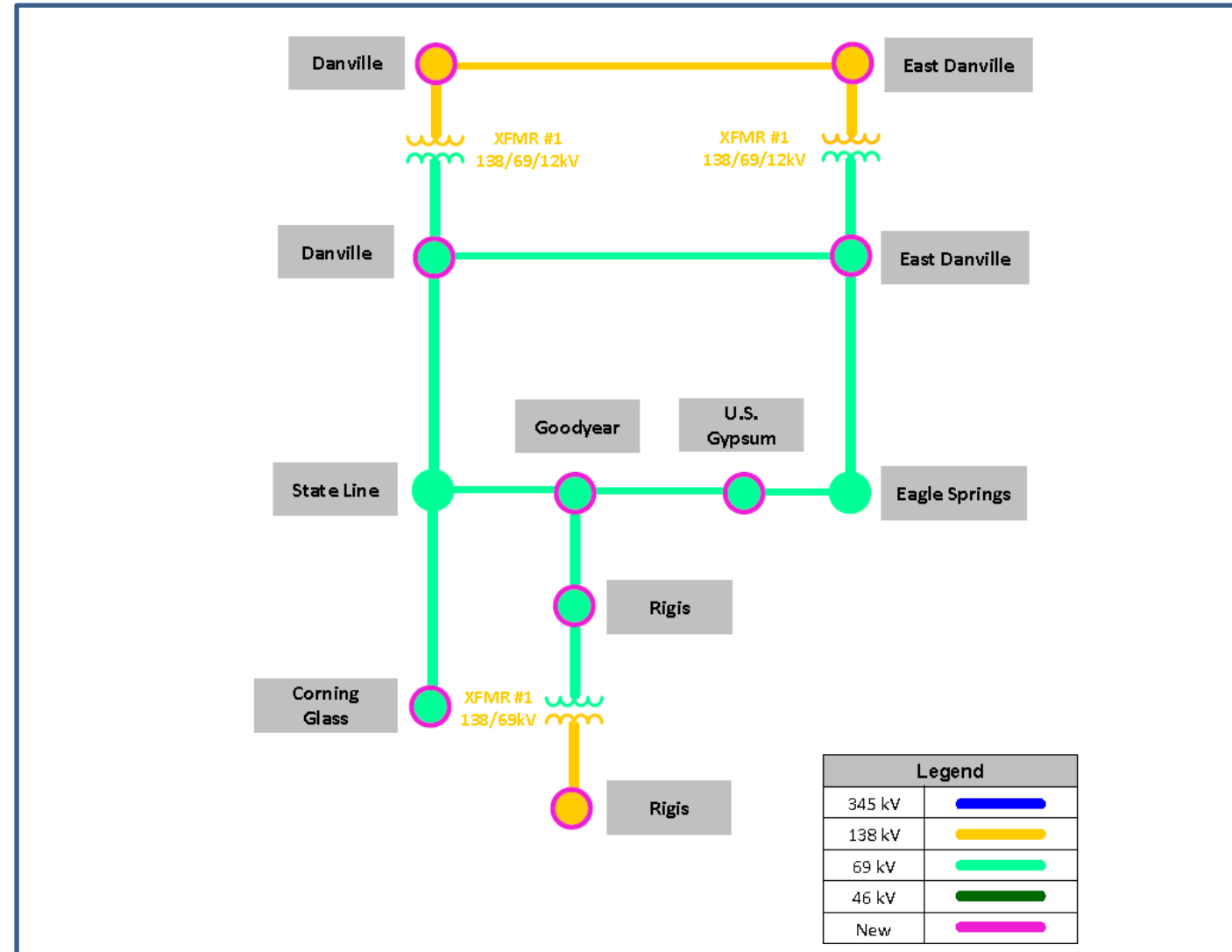

AEP Transmission Zone M-3 Process Danville Area

Continued from previous slide ...

At US Gypsum station, install 69 kV line relaying and CCVT's on both the East Danville line and Goodyear line. Install required fiber and retire all pilot wire associated with the Goodyear –U.S. Gypsum and East Danville circuits. Replace 69 kV breaker A with 3000 A, 40 kA breaker and 2000 A disconnect switches. Replace 69 kV customer metering with 3 element CT/PT combo. **(S2143.6) Estimated Cost: \$2.8M**

At Corning Glass station, install required fiber and retire all pilot wire. Replace 69 kV breaker B with 3000 A, 40 kA circuit breaker and 2000 A disconnect switches. Replace 69 kV circuit switcher A with 3000 A, 40 kA circuit breaker and 2000 A disconnect switches. Replace 69 kV circuit switcher AA with 600 A, 40 kA capacitor switcher. **(S2143.7) Estimated Cost: \$0 (Distribution)**

At Ridgeway station, upgrade remote end relaying. **(S2143.8) Estimated Cost: \$0.6M**

At Smith Mountain station, upgrade remote end relaying and replace breaker control cables. **(S2143.9) Estimated Cost: \$0.9M**

On the Danville-East Danville 69 kV line, replace 4 wood structures to accommodate additional loading of new ADSS and install ADSS under-build. **(S2143.10) Estimated Cost: \$1.1M**

On the Corning Glass-Goodyear 69 kV line, replace 13 wood structures to accommodate additional loading of new ADSS and install ADSS under-build. **(S2143.11) Estimated Cost: \$1.9M**

On the Goodyear-Rigis 69 kV line, replace 4 wood structures to accommodate additional loading of new ADSS and install ADSS under-build. **(S2143.12) Estimated Cost: \$0.9M**

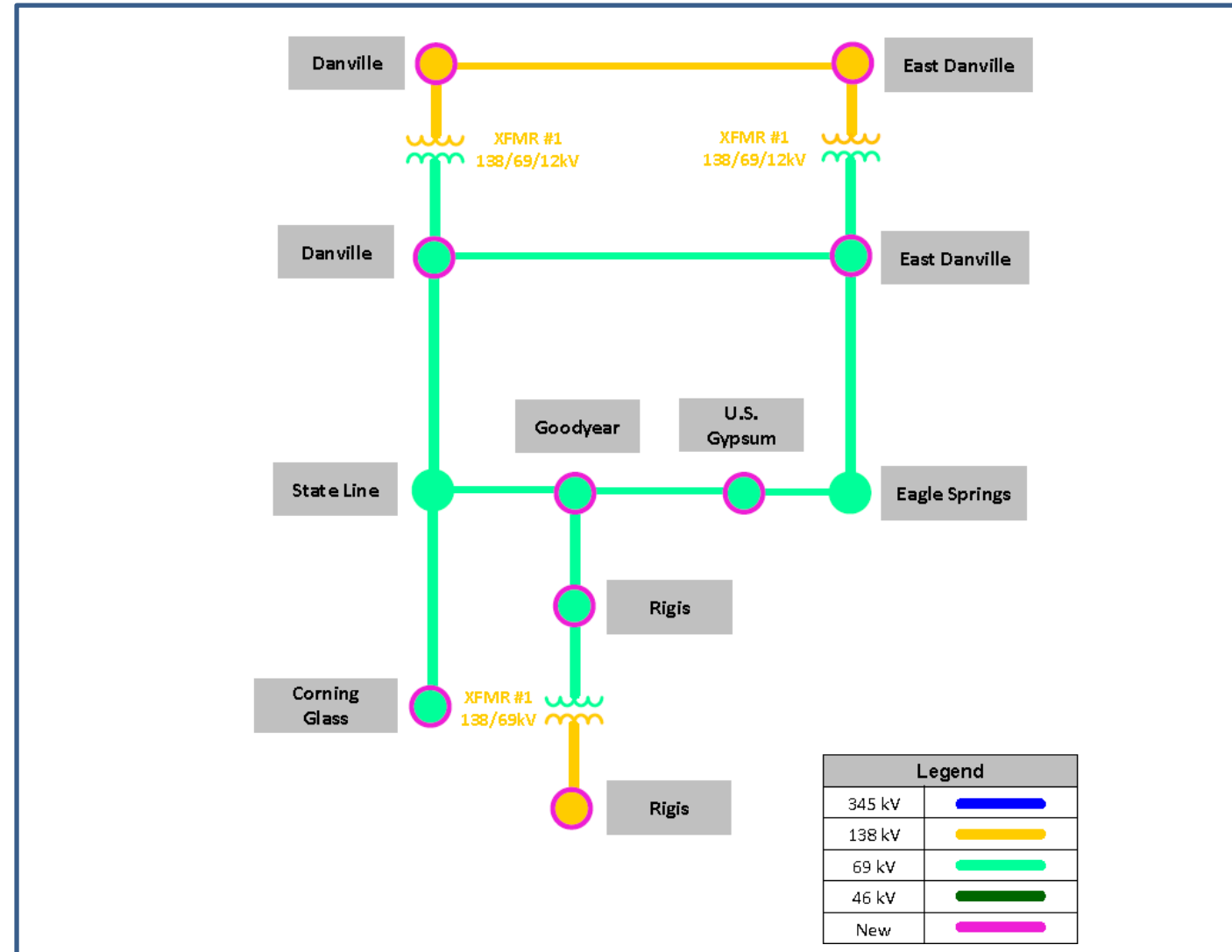

AEP Transmission Zone M-3 Process Danville Area

Continued from previous slide ...

On the Ballou-Danville 69 kV line, replace 14 wood structures to accommodate additional loading of new ADSS and install ADSS under-build. **(S2143.13) Estimated Cost: \$2.0M**

On the Ballou-State Line 69 kV line, replace 3 wood structures to accommodate additional loading of new ADSS and install ADSS under-build. **(S2143.14) Estimated Cost: \$0.8M**

On the Goodyear-US Gypsum 69 kV line, replace 2 wood structures to accommodate additional loading of new ADSS and install ADSS under-build. **(S2143.15) Estimated Cost: \$0.4M**

Estimated Cost: \$26.7M

Projected In-Service: 10/31/2022

Supplemental Project ID: (S2143.1-.15)

Project Status: Scoping

Model: 2024 RTEP

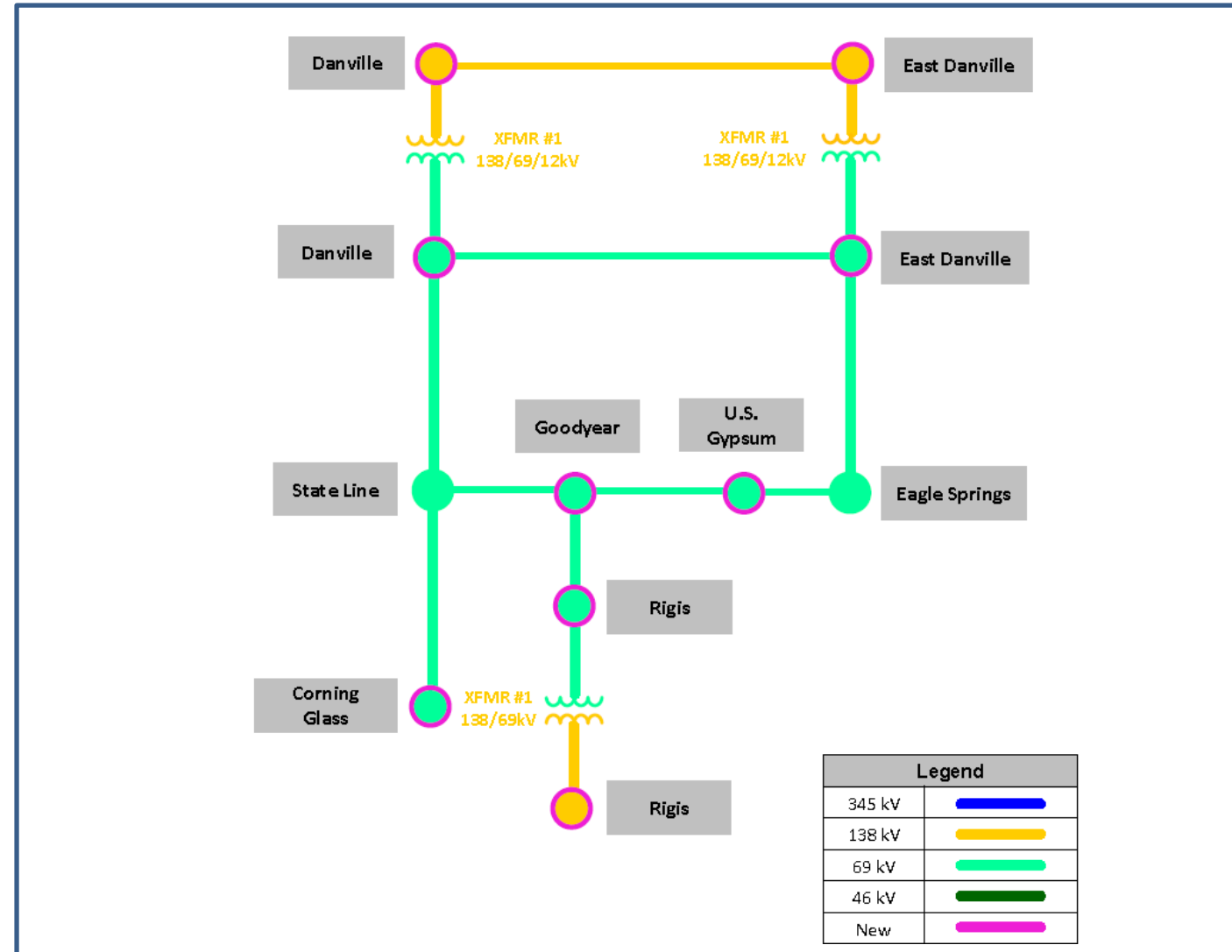

AEP Transmission Zone M-3 Process Trap Hill Area Project

Need Number: AEP-2019-AP016

Process Stage: Submission of Supplemental Project for inclusion in the Local Plan 1/29/2020

Previously Presented:

Needs Meeting 5/20/2019

Solutions Meeting 11/22/2019

Project Driver:

Equipment Material/Condition/Performance/Risk

Specific Assumption Reference:

AEP Guidelines for Transmission Owner Identified Needs (AEP Assumptions Slide 8)

Problem Statement:

- Trap Hill Station serves approximately 20 MVA of load from a 6 mile radial thus exceeding AEP's threshold for looped service of 75 MVA-mile. Long radial line or radial lines serving a significant amount of load are concerning as they age due to:
 - Maintenance of radial facilities being difficult due to the required customer outages.
 - Radial delivery points resulting in extended outages to customers for any loss of the feed due to the lack of looped service and transferability of the load.
- Bolt Tap 138 kV is a hard tap off the Baileysville – Sundial 138 kV #1 circuit.
 - Hard taps are difficult to maintain due to required outages or temporary jumper configurations in lieu of a switch.
 - It can also result in extended outages to customers due to the inability to sectionalize faulted facilities.
- Dameron 46 kV CB-A
 - Oil filled ITE 69KA-2500-12D type breaker, 1 of 13 of this type of model left on the AEP system.
 - These types of breakers experience issues with their parts and maintenance costs due to lack of vendor support.
 - Oil breakers are more difficult to maintain as oil spills have the potential to occur during maintenance which could pose an environmental and safety hazard.

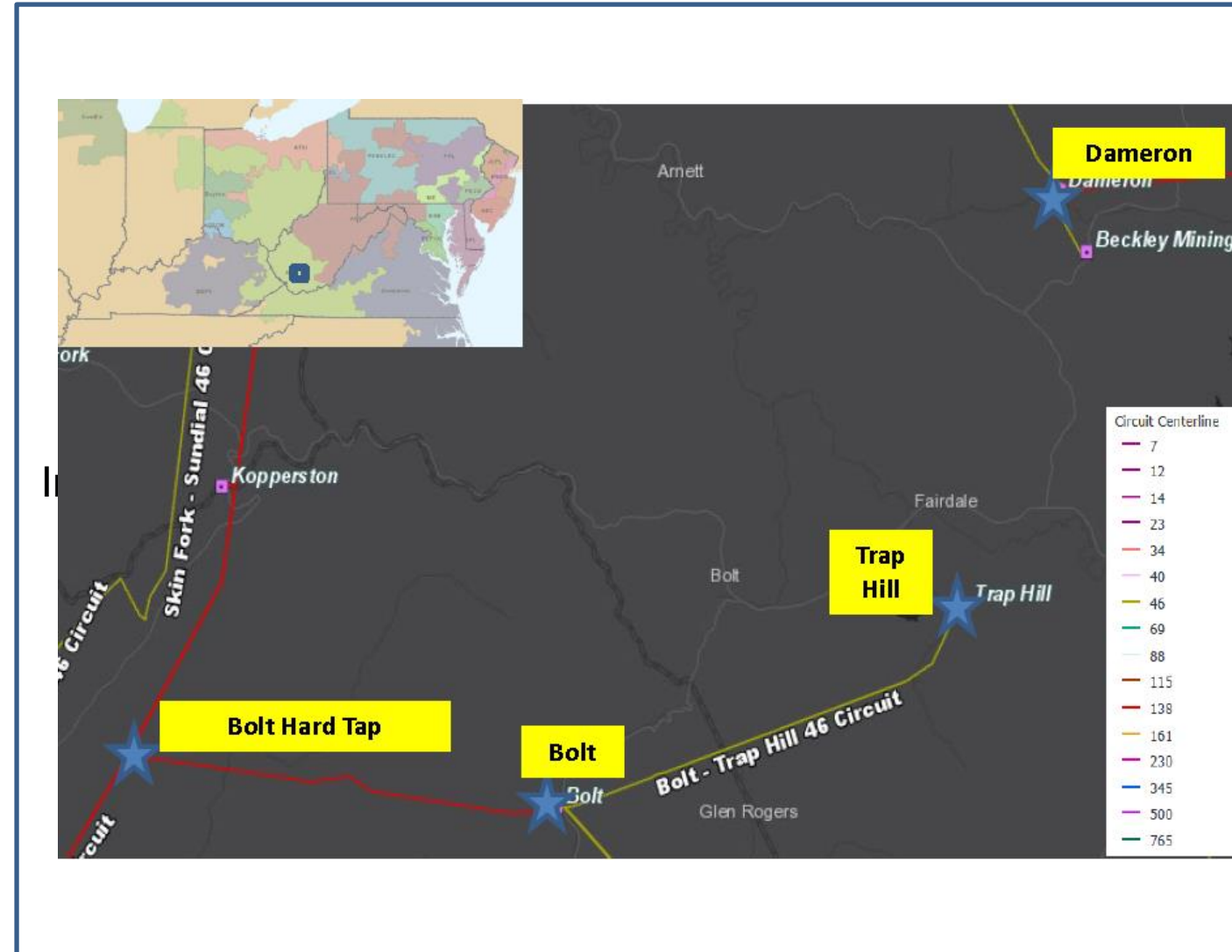

AEP Transmission Zone M-3 Process Trap Hill Area Project

Problem Statement (cont'd):

- Dameron 46 kV Cap switcher AA
 - S&C 2030-69 unit that has no gas monitor and sister units on the AEP system have experienced 62 malfunctions since 1999. Major events include gas loss, interrupter failures, and operating mechanism failures.
- Dameron 138/46 kV Bank #1
 - Rising moisture, carbon monoxide (CO), and carbon dioxide (CO2) levels which indicate a deterioration of the insulating paper.
 - Sustained low levels of interfacial tension also ties to insulation degradation and is an indication of sludge formation. Sludge can impede oil circulation and generate numerous instances of overheating, further accelerating the declining health of the unit.
 - The current MOAB/Ground SW configuration on the high side.
- Dameron grounding transformer
 - 99 year old unit in which all 3 phases are facing similar condition issues.
 - Sustained elevated moisture levels and power factor have led to decreasing dielectric strength.
 - Sustained low levels of interfacial tension is an indication of sludge formation.
 - Sludge can impede oil circulation and generate numerous instances of overheating, further accelerating the declining health of the unit.
- Dameron Substation currently deploys 41 relays, implemented to ensure the adequate protection and operation of the substation.
 - Currently, 36 of the 41 relays (88% of all station relays) are in need of replacement.
 - There are 33 of the electromechanical type and 1 static type which have significant limitations with regards to fault data collection and retention. In addition, 2 microprocessor relays were commissioned in 1997 and 2005, indicative of obsolete firmware that is no longer vendor supported.

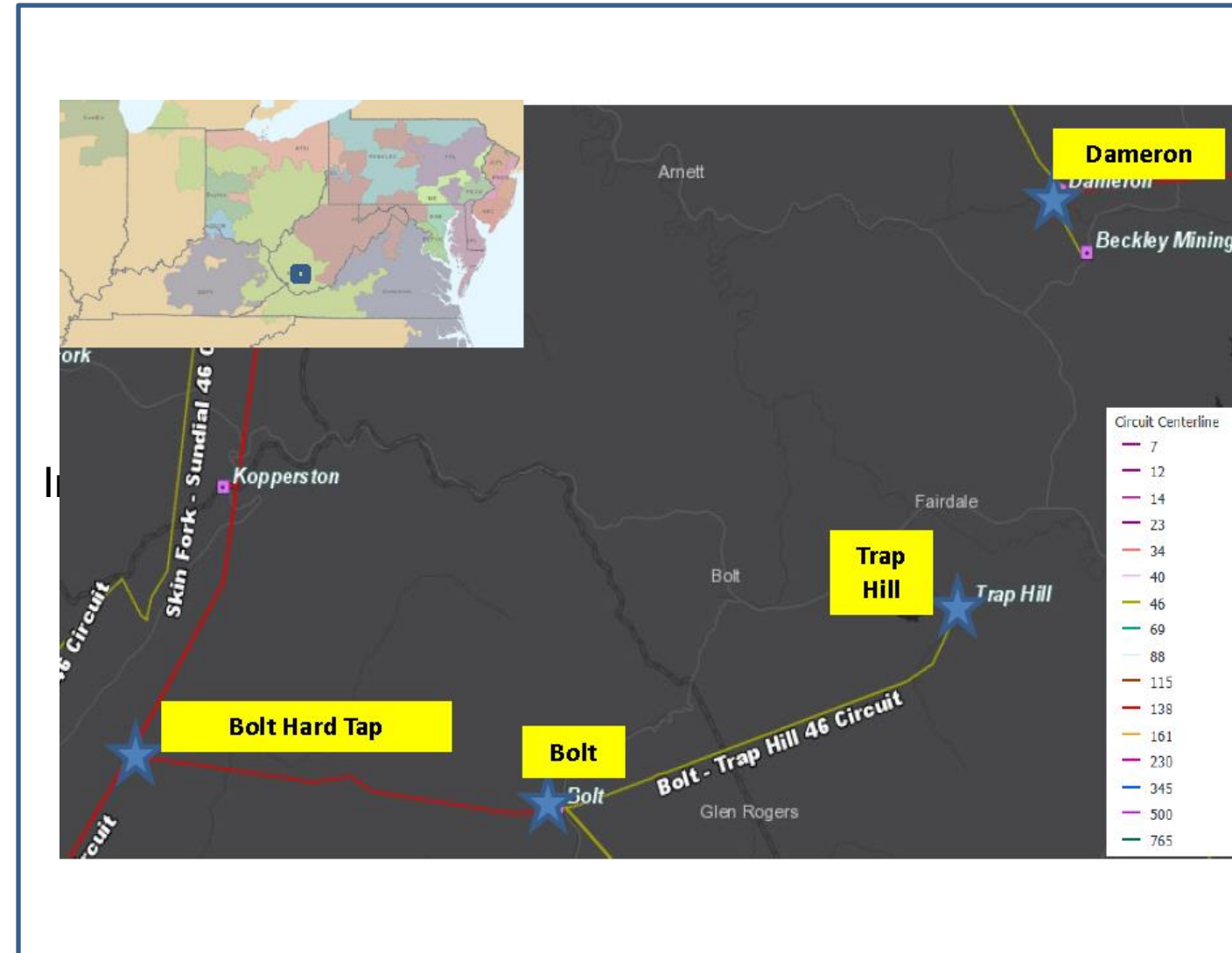

AEP Transmission Zone M-3 Process Trap Hill Area Project

Problem Statement (cont'd):

- Bolt 46 kV cap switcher AA
 - 1 of 15 remaining VBM-69 types left on the AEP system.
 - These types of cap switchers perform poorly in cold weather and replacement parts are known to be expensive when they are available per the TFS obsolete list.
- Bolt 46 kV grounding transformer
 - All 3 phases are facing similar condition issues as listed.
 - Sustained elevated moisture levels and power factor have led to decreasing dielectric strength.
 - Sustained low levels of interfacial tension is in indication of sludge formation, in which sludge can impede oil circulation and generate numerous instances of overheating, further decreasing the health of the unit.
- Bolt 138/46 kV XFR
 - Moisture levels and power factor have been on the rise since 2004. These increases correspond to decreasing dielectric strength levels seen over the same period. The most probable causes of moisture in oil for this unit are paper breakdown (aging), moisture ingress through gaskets, and leaks (main tank; pumps; etc.).
 - Interfacial tension has been at a sustained low level since 2008; this is an early indication of the development of sludge from contaminants in the oil. Over time, the sludge can further impede the ability of oil to properly circulate, potentially leading to more frequent unit overheating.

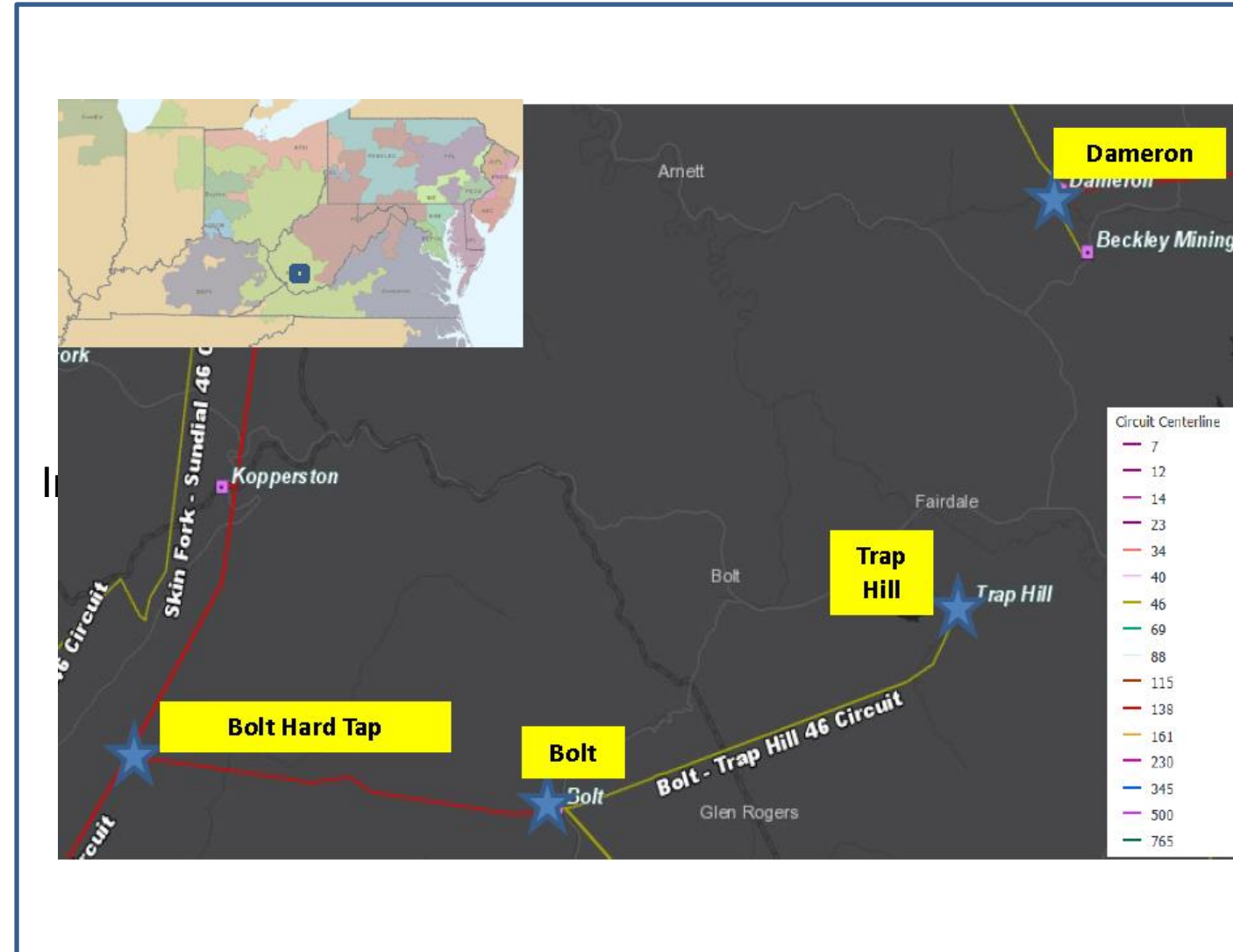

AEP Transmission Zone M-3 Process Trap Hill Area Project

Need Number: AEP-2019-AP016

Process Stage: Submission of Supplemental Project for inclusion in the Local Plan 1/29/2020

Selected Solution:

Construct a new 138 kV line (~6 miles) from Dameron to Trap Hill. Convert the Bolt – Trap Hill 46kV line to 138kV (line is already built to 138kV standards). **(S2144.1) Estimated Cost: \$15.1M**

Convert Trap Hill station to 138kV, install two 138 kV 3000 A 40 kA circuit breakers. **(S2144.2) Estimated Cost: \$2.0M**

At Bolt Station, install 138 kV bus and configure the 138kV station into a ring configuration with three new 138kV 3000A 40kA breakers. Replace the existing ground transformer with a new ground transformer. Replace existing cap switcher AA with a new 46 kV 420 A (capacitive current) 40 kA cap switcher. Replace the existing 138/46 kV 75 MVA XFR with a new 138/46 kV 90 MVA XFR. **(S2144.3) Estimated Cost: \$6.4M**

At Dameron Station, Install 138 kV bus and configure the 138kV station into a ring bus layout utilizing four new 138kV 3000A 40kA breakers. Remove the ground switch MOAB scheme from the high side of XF1. Associated line work to accommodate new 138 kV ring configuration. Replace the existing circuit breaker A with a new 46 kV 3000A 40 kA circuit breaker. Replace the existing cap switcher AA with a new 46 kV 450 A (capacitive current) 40 kA cap switcher. Replace the existing 138/46kV 75 MVA XF #1 with a new 138/46kV 75 MVA XF. Replace the existing grounding transformer with a new grounding transformer. Replace existing 46/34.5 kV XFR with a new 138/34.5 kV 30 MVA XFR. Station fence will need expanded to accommodate new 138 kV bus. Retire Beckley Mining 46 kV line out of Dameron and transfer customer to Distribution service. Customer Service is following up with the customer regarding the new service. **(S2144.4) Estimated Cost: \$10.5M**

Construct an in/out line from the existing Baileysville – Sundial #1 line to the new Bolt Tap Station (~2 miles). **(S2144.5) Estimated Cost: \$7.4M**

At the new Bolt Tap Station install three 138 kV 3000 A 40 kA circuit breakers into a breaker and a half configuration. **(S2144.6) Estimated Cost: \$8.0M**

Total Estimated Transmission Cost: \$49.4M

Projected In-Service: 11/1/2022

Supplemental Project ID: S2144.1-6

Project Status: Scoping

Model: N/A

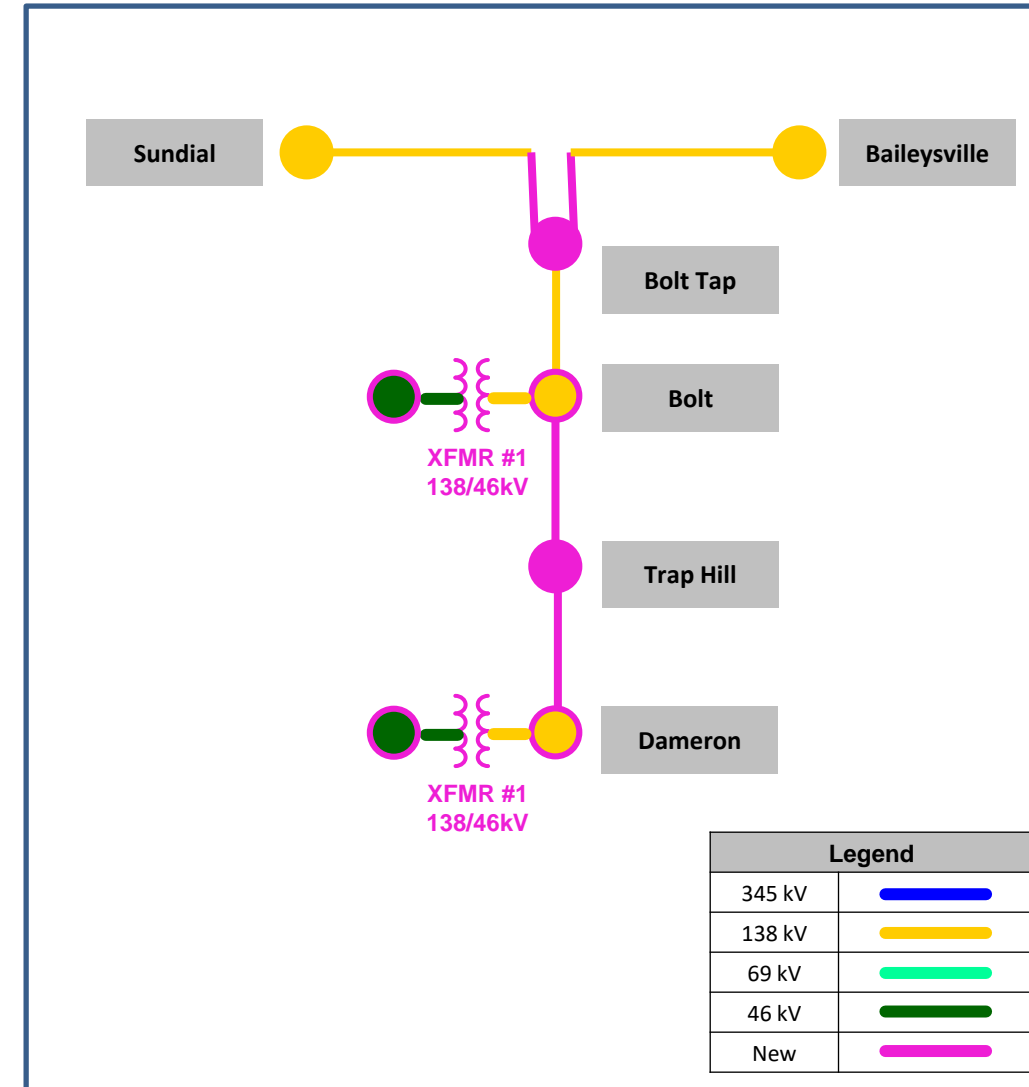

AEP Transmission Zone M-3 Process Amos – Hopkins Line Rebuild

Need Number: AEP-2019-AP023

Process Stage: Submission of Supplemental Project for inclusion in the Local Plan 1/29/2020

Previously Presented:

Needs Meeting 7/24/2019

Solutions Meeting 11/22/2019

Project Driver:

Equipment Condition/Performance/Risk

Specific Assumption Reference:

AEP Guidelines for Transmission Owner Identified Needs (AEP Assumptions Slide 8)

Problem Statement:

Amos – Hopkins 138 kV (~31.37 miles)

- Majority of the circuit is constructed with 1920s lattice structures
 - The lattice towers used for this line are approximately 94 years old. Structure loading does meet the NESC 250B, 250C and 250D standards for all structures that were analyzed.
 - Steel lattice towers and hardware are currently exhibiting medium to heavy rust
- The shield wire and conductor for this line is 94 years old. Current shielding for the majority of the line does not comply with current standards.

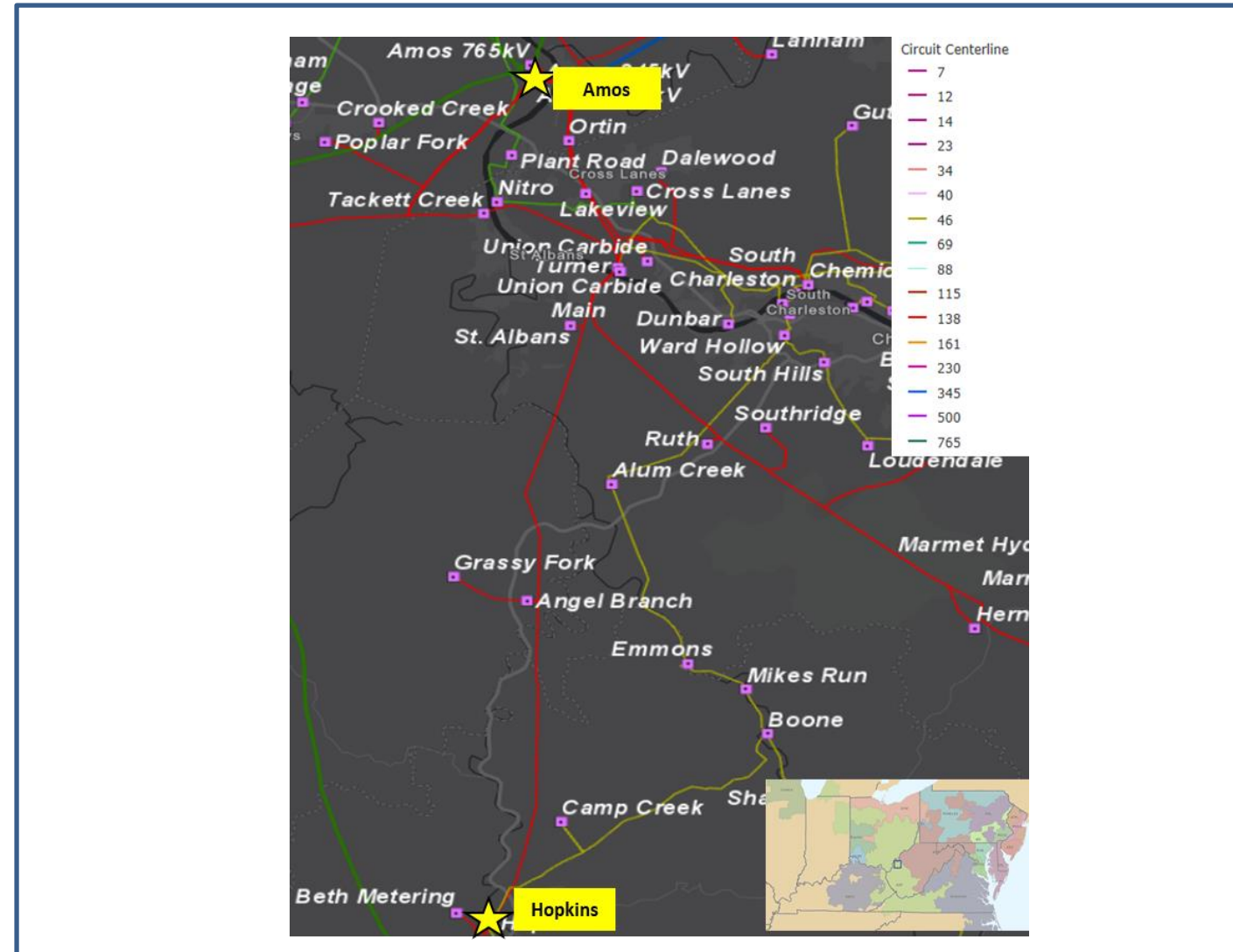

AEP Transmission Zone M-3 Process Amos – Hopkins Line Rebuild

Need Number: AEP-2019-AP023

Process Stage: Submission of Supplemental Project for inclusion in the Local Plan 1/29/2020

Selected Solution:

- Rebuild the Amos – Hopkins 138kV circuit from structure 124-8A to Hopkins station as single circuit (~19.6 miles), including structure work near Saint Albans Tap and Angel Branch Tap. **(S2145.1) Estimated Trans. Cost: \$61.3M**
- Remote end work at Amos Station. **(S2145.2) Estimated Trans. Cost: \$0.1M**

Estimated Cost: \$61.4M

Projected In-Service: 12/1/2022

Supplemental Project ID: S2145.1-.2

Project Status: Scoping

Model: N/A

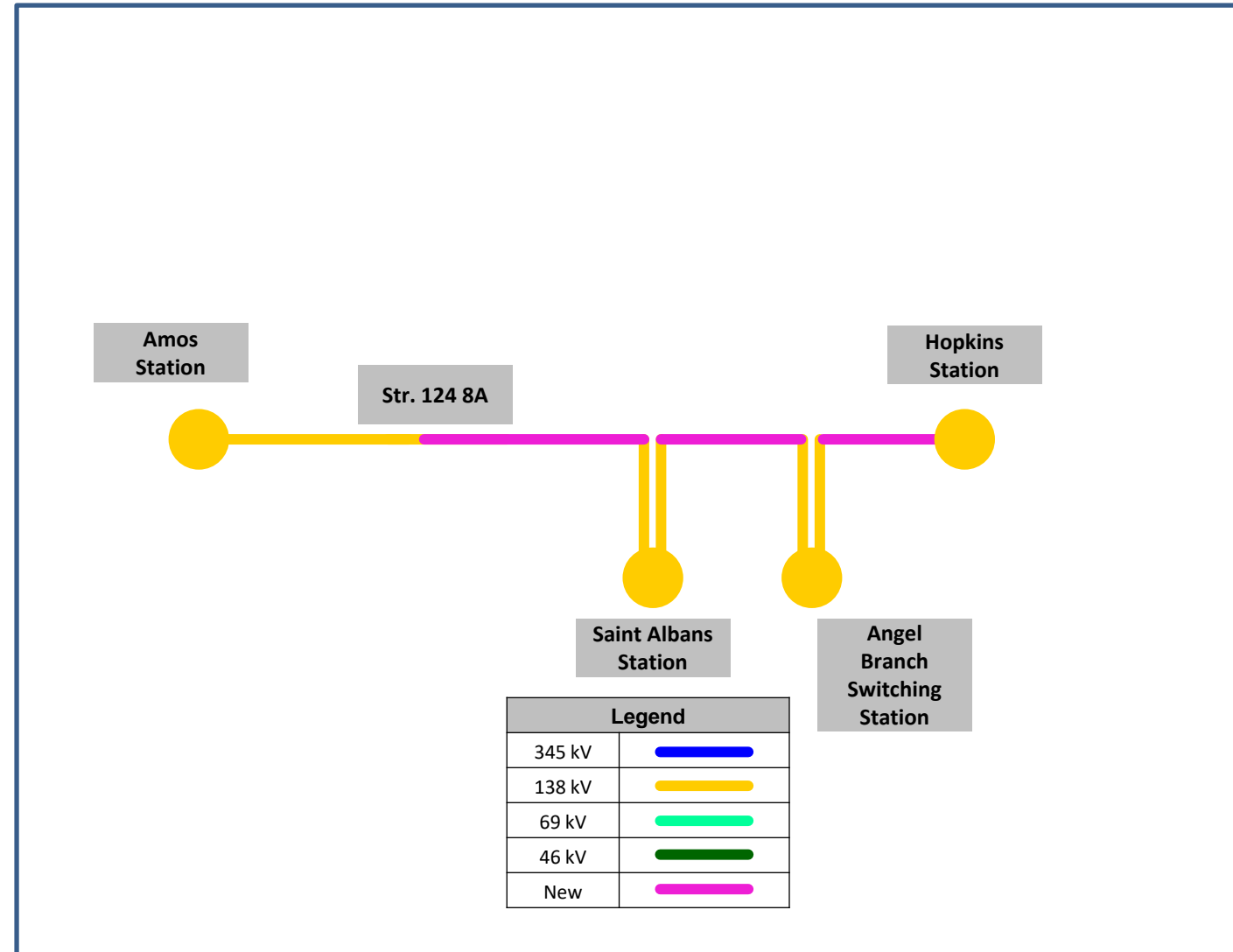

AEP Transmission Zone M-3 Process Delaware – Kenmore 34.5kV Rebuild

Need Number: AEP-2019-IM024

Process Stage: Submission of Supplemental Project for inclusion in the Local Plan 1/29/2020

Previously Presented:

Needs Meeting 6/17/2019

Solutions Meeting 11/22/2019

Project Driver:

Equipment Material/Condition/Risk/Performance

Specific Assumption Reference:

AEP Guidelines for Transmission Owner Identified Needs (AEP Assumptions Slide 8)

Problem Statement:

Delaware – Bethel overhead 34.5kV Line (2.8 miles)

- 1960's vintage wood construction.
- 16 open conditions all related to structural issues.
- Issues with ROW encroachments.

Bethel – Kenmore underground 34.5kV line (.8 miles)

- 1960's vintage underground construction
- Both cables are through common man-hole ducts, which can present a safety issue. Currently TFS personal will not work on this line unless both northern feeds to Kenmore are de-energized due to this configuration.
- Underground construction makes it difficult to identify and fix outages. This means that as this cable ages, the area will start experiencing prolonged forced outages. This line has already experienced multiple of these type of outages.
- This UG section was out for 14 straight days in June 2010 and 29 straight days in August 2017

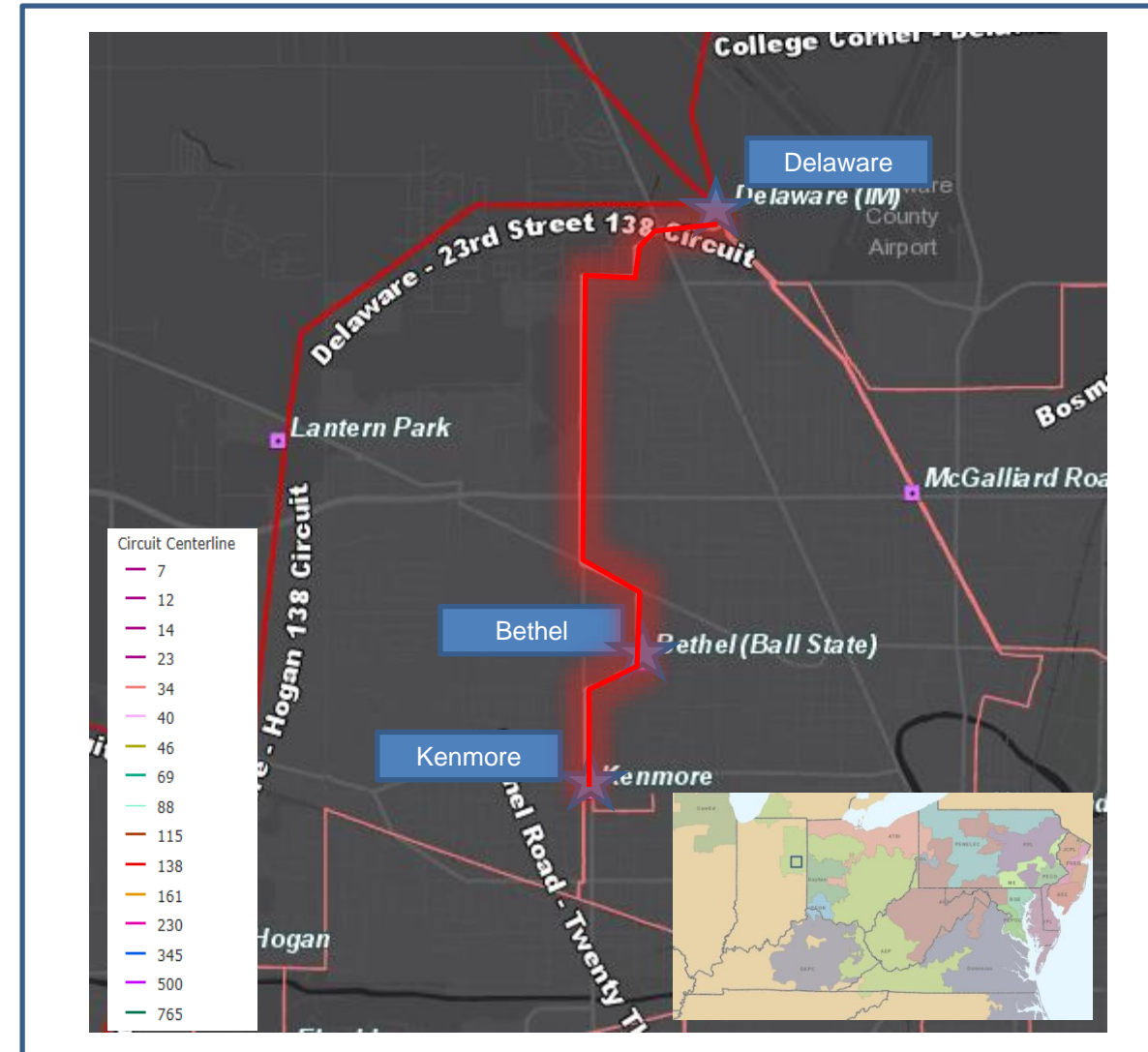

AEP Transmission Zone M-3 Process Delaware – Kenmore 34.5kV Rebuild

Need Number: AEP-2019-IM024

Process Stage: Submission of Supplemental Project for inclusion in the Local Plan 1/29/2020

Selected Solution:

Rebuild the ~3 miles of overhead between Delaware and Bethel station. ~2.5 miles will be rebuilt as overhead and ~.5 miles will be rebuilt as underground. **(S2146.1) Estimated Cost: \$16.8M**

Rebuild the ~1 mile of underground between Kenmore and Bethel stations **(S2146.2) Estimated Cost: \$12.8M**

At Delaware station, install 2 series reactors to lower short circuit contribution toward Kenmore **(S2146.3)**

Estimated Cost: \$0.85M

At Arnold Hogan station, install 1 series reactor to lower short circuit contribution toward Kenmore **(S2146.4)**

Estimated Cost: \$0.41M

At 23rd Street station, install 1 series reactors to restrict flow and lower short circuit contribution toward Kenmore. **(S2146.5)**

Estimated Cost: \$0.41M

Total Estimated Transmission Cost: \$31.3M

Projected In-Service: 10/01/2023

Supplemental Project ID: S2146.1-5

Project Status: Scoping

Model: N/A

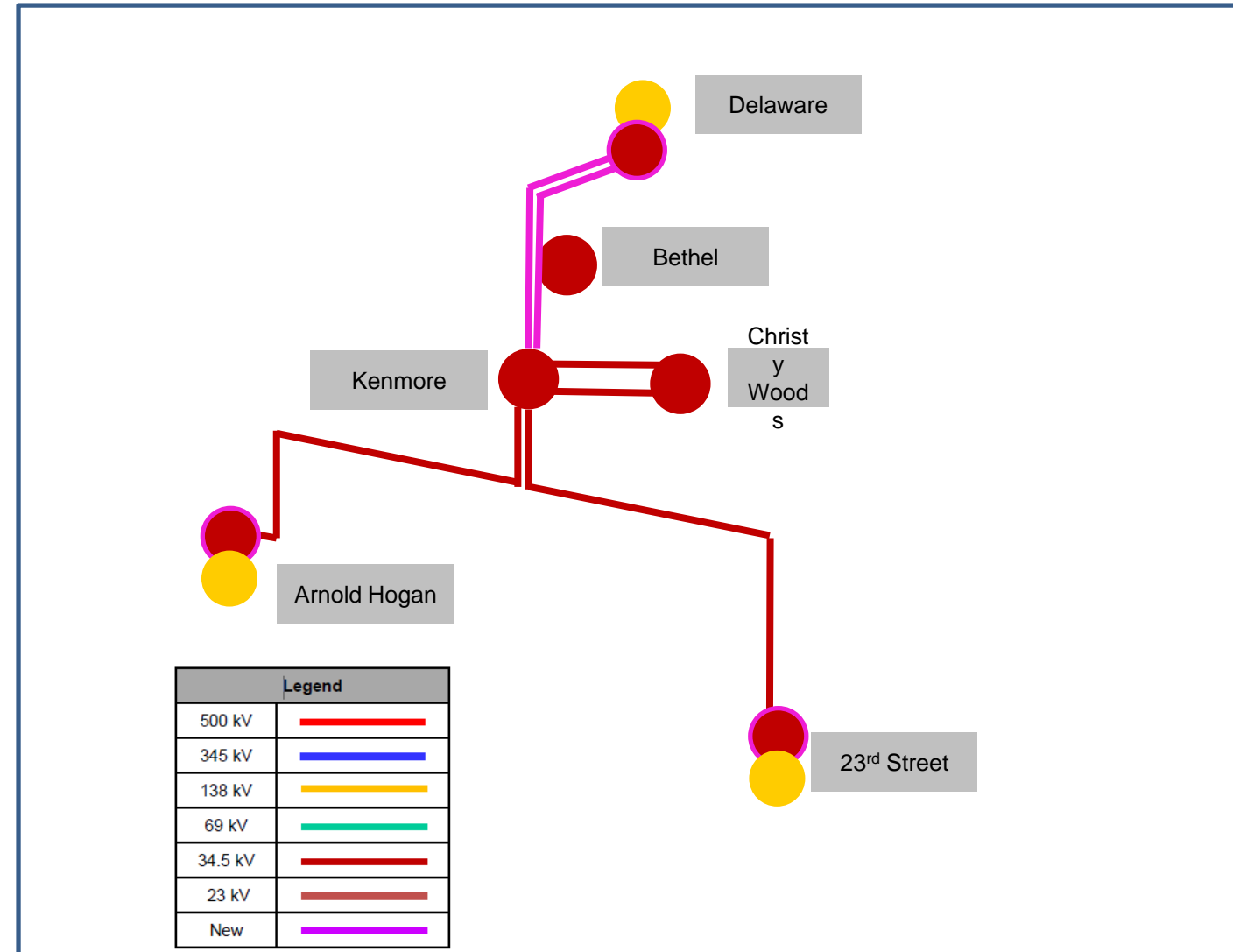

AEP Transmission Zone M-3 Process

Lakin – Racine Rebuild

Need Number: AEP-2018-AP013

Process Stage: Submission of Supplemental Project for inclusion in the Local Plan 02/06/2020

Previously Presented:

Needs Meeting 1/11/2019

Solutions Meeting 12/18/2019

Project Driver:

Equipment Condition/Performance/Risk

Specific Assumption Reference:

AEP Guidelines for Transmission Owner Identified Needs (AEP Assumptions Slide 8)

Problem Statement:

- The Lakin – Racine 69 kV circuit (~13.2 mi) currently has 125 open conditions on 70% of the structures.
 - These conditions include rot top, woodpecker damage, burnt insulator, broken knee/V braces.
 - The majority of the circuit is constructed with 1960s wood structures. From 2015-2018, the line has experienced 8 momentary and 3 permanent outages which have resulted in 27k customer minutes of interruption.
- The 69kV CB F at Lakin is a CF type oil filled breaker.
 - Oil filled breakers have significant maintenance requirements due to oil handling.
 - This CB model family has experienced numerous documented mechanism bearing issues and failures within the AEP population.
- Lakin Substation deploys 42 relays implemented to ensure the adequate protection and operation of the substation. Currently 35 of the 42 relays (83% of all station relays) are in need of replacement.
 - There are 32 electromechanical, 2 legacy ABB DPU microprocessor, and 1 static type relays with significant limitations in regards to spare part availability in addition to a lack of vendor support.
 - The electromechanical and static relays have no capability for fault data collection and retention. The ABB DPU relays pose a safety risk to persons performing breaker operation because the DPUs are mounted directly on the circuit breaker without a delay for opening and closing the breaker.
 - If there is any arcing or something goes wrong as the breaker operates, the operator is now in the line of fire. Modern relays can program a delay (10 seconds) after an open or close button is pressed so the operator can have time to walk out of the line of fire.
- The 138kV line switches are mounted on cap and pin insulators at Lakin.
- The current MOAB/Ground SW configurations at Lakin create faults in the station to signal the remote end breakers to open; this results in Transmission lines breakers getting burdened to clear Transformer faults thus reducing their life span.
- Lakin 138/69 kV transformer bank #1 CO and CO2 levels have been on the rise since 2004 when all transformer bushings were replaced during minor transformer maintenance activities; the oil was processed at that time, accounting for the rapid decrease in gas concentrations in 2004. The latest CO reading of 493ppm is significantly high.
 - Moisture content had been trending up from 2008 to 2016 and has been in excess of 25ppm since 2016. Dielectric strength is currently trending up, but this rapid and significant 15.1kV increase was unexpected given the minor drop in moisture content levels from 2016 to 2017.
 - Together, these are potential indicators of insulating paper breakdown.
 - In addition, H2 concentrations have been rising since 2004. The presence of H2 indicates the potential for stray gassing in the oil and carbonization of the insulating paper.
 - The above conditions indicate a strong probability of degradation of the integrity of the paper insulation surrounding the transformer windings from carbonization, breakdown in cellulose, or both.

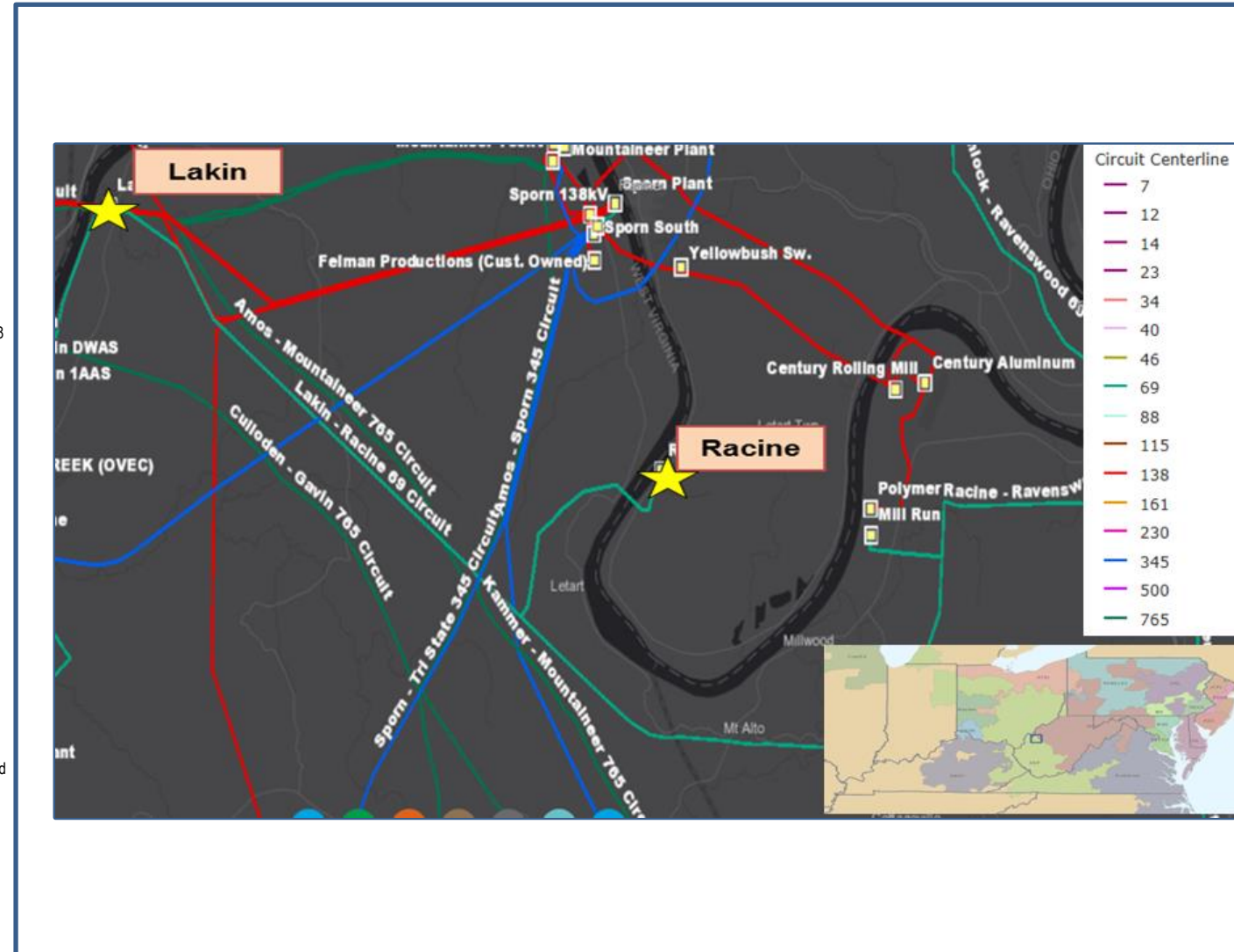

AEP Transmission Zone M-3 Process Lakin – Racine Rebuild

Need Number: AEP-2019-AP008

Process Stage: Submission of Supplemental Project for inclusion in the Local Plan 02/06/2020

Previously Presented:

Needs Meeting 3/25/2019

Solutions Meeting 12/18/2019

Project Driver:

Equipment Condition/Performance/Risk

Specific Assumption Reference:

AEP Guidelines for Transmission Owner Identified Needs (AEP Assumptions Slide 8)

Problem Statement:

Racine 69 kV circuit breaker B

- CG-48 oil type breakers that was manufactured in 1980.
- Oil breakers are more difficult to maintain as oil spills have the potential to occur during maintenance which can be an environmental and safety hazard.
- Experienced 43 fault operations, exceeding the manufacturer's designed number of fault operations of 10.

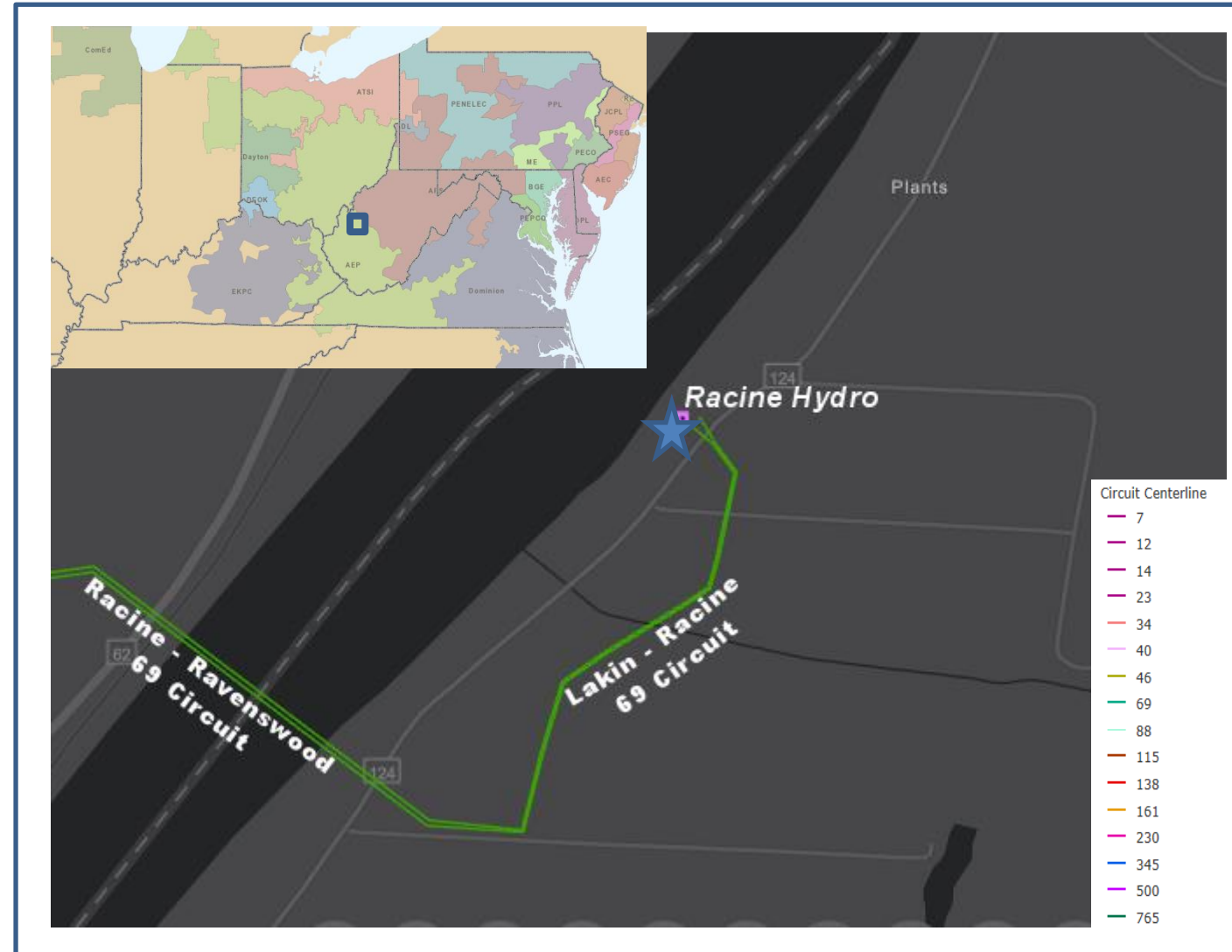

AEP Transmission Zone M-3 Process Lakin – Racine Rebuild

Need Number: AEP-2018-AP013, AEP-2019-AP008

Process Stage: Submission of Supplemental Project for inclusion in the Local Plan 02/06/2020

Selected Solution:

Rebuild Racine Hydro double circuit 69 kV line (~4 miles) to 69 kV standards utilizing 795 26/7 ACSR conductor (W.N. 162 MVA, W.E. 202 MVA) **(S2166.1) Estimated Cost: \$15.9M**

Lakin Station: Remove existing 138 kV line switches and MOAB/Gr. Sw. Install 4 new 138 kV 40 kA 3000 A circuit breakers in a ring configuration. Replace existing 138/69 kV 90 MVA XFR #1 with a new 138/69 kV 90 MVA XFR. Replace existing 69 kV CB-F with a new 69 kV 40 kA 3000 A circuit breaker. Associated remote end work at Sporn, Gavin and Point Pleasant Stations. **(S2166.2) Estimated Cost: \$14.5M**

Reconfigure the Sporn – Lakin – Gavin 138 kV line entrance and the Lakin – Point Pleasant 69 kV line entrance into the new station layout. **(S2166.3) Estimated Cost: \$1.6M**

Racine Station: Replace existing 69 kV circuit breaker with a new 69 kV 40 kA 3000 A circuit breaker. Associated remote end work at Ravenswood station. **(S2166.4) Estimated Cost: \$1.4M**

Ancillary Benefits: Supplemental solution combined with Baseline Projects b3040 and b3095 for holistic area solution.

Total Estimated Cost: \$33.4 M

Projected In-Service: 6/1/2022

Supplemental Project ID: S2166.1-.4

Project Status: Scoping

Model: 2022 Winter RTEP

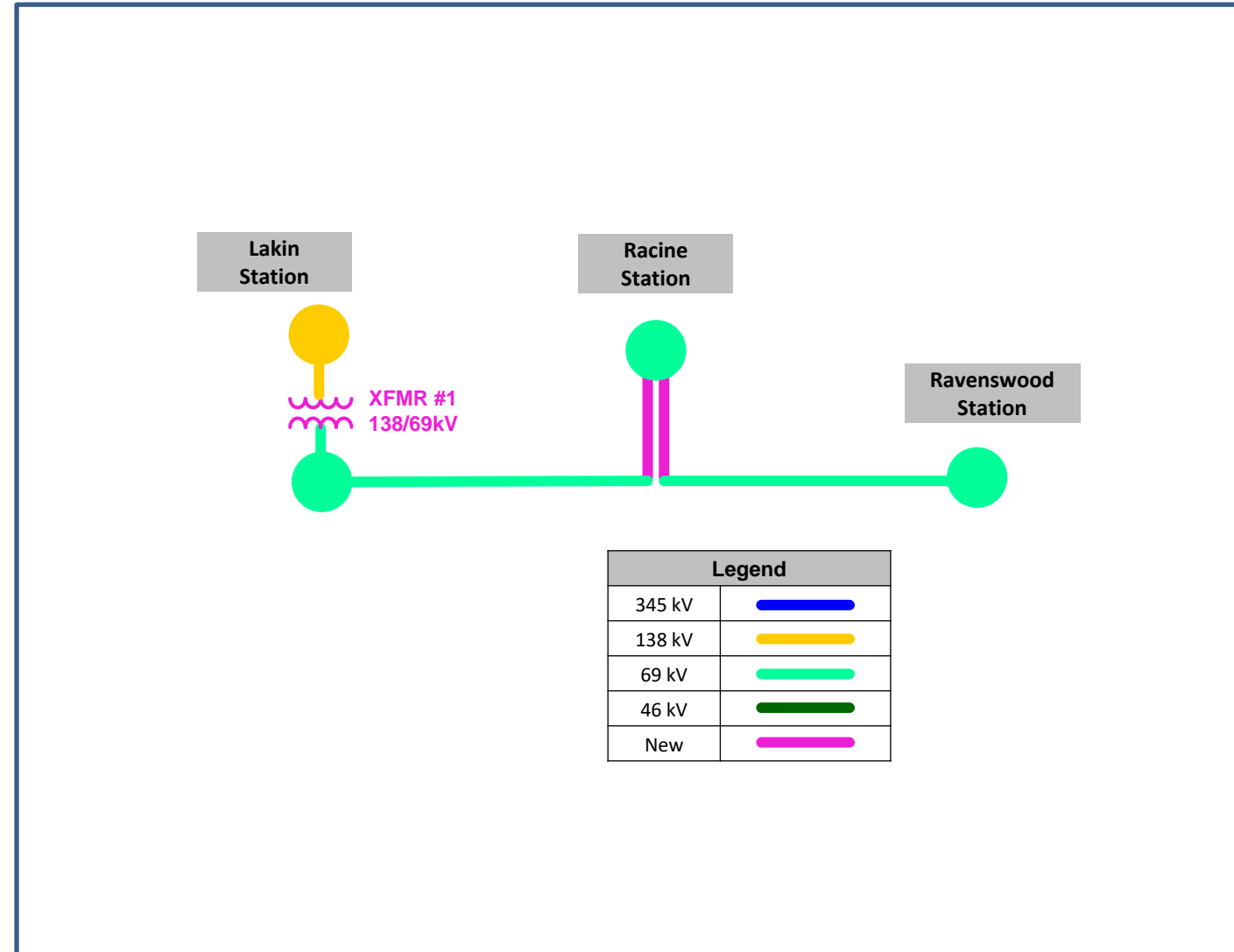

AEP Transmission Zone M-3 Process Bancroft – Turner Rebuild

Need Number: AEP-2018-AP019

Process Stage: Submission of Supplemental Project for inclusion in the Local Plan
02/06/2020

Previously Presented:

Needs Meeting 1/11/2019

Solutions Meeting 12/18/2019

Project Driver:

Equipment Material/Condition/Performance/Risk

Specific Assumption Reference:

AEP Guidelines for Transmission Owner Identified Needs (AEP Assumptions Slide 8)

Problem Statement:

Nitro 69 kV circuit breakers G and H are CF-48 oil type breakers that were manufactured in the 1960s. In general, oil breakers are more difficult to maintain as oil spills have the potential to occur during maintenance, which could cause environmental and safety hazards. In addition, breakers G and H have experienced 42 and 39 faults of operation, respectively. These both exceed the manufacturer's designed number of fault operations of 10.

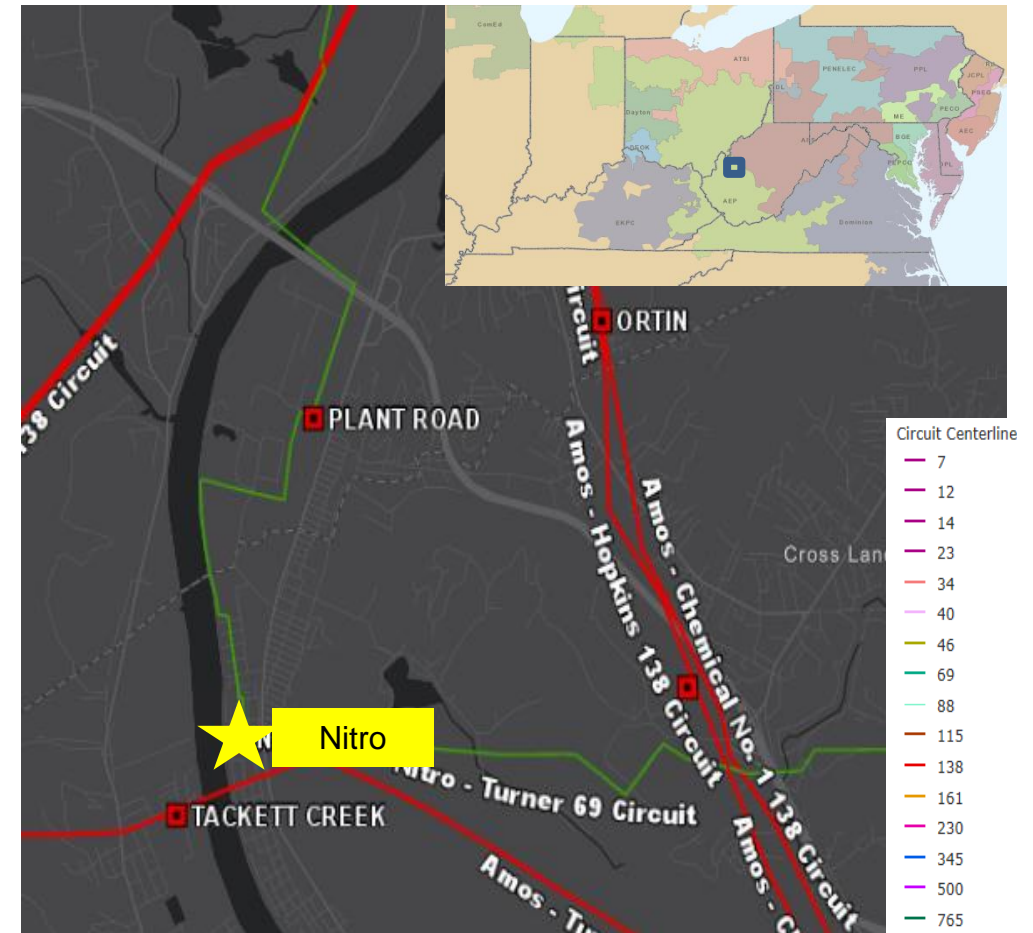

AEP Transmission Zone M-3 Process Bancroft – Turner Rebuild

Need Number: AEP-2019-AP011

Process Stage: Submission of Supplemental Project for inclusion in the Local Plan 02/06/2020

Previously Presented:

Needs Meeting 4/23/2019

Solutions Meeting 12/18/2019

Project Driver:

Equipment Material/Condition/Performance/Risk

Specific Assumption Reference:

AEP Guidelines for Transmission Owner Identified Needs (AEP Assumptions Slide 8)

Problem Statement:

- 69 kV circuit breakers F and G at Bancroft station are CF-48 oil type breakers that were manufactured in 1965.
 - Oil breakers are more difficult to maintain as oil spills have the potential to occur during maintenance which can be an environmental and safety hazard.
 - Breakers F and G have experienced 55 and 70 fault operations, exceeding the manufacturer's designed number of fault operations of 10.

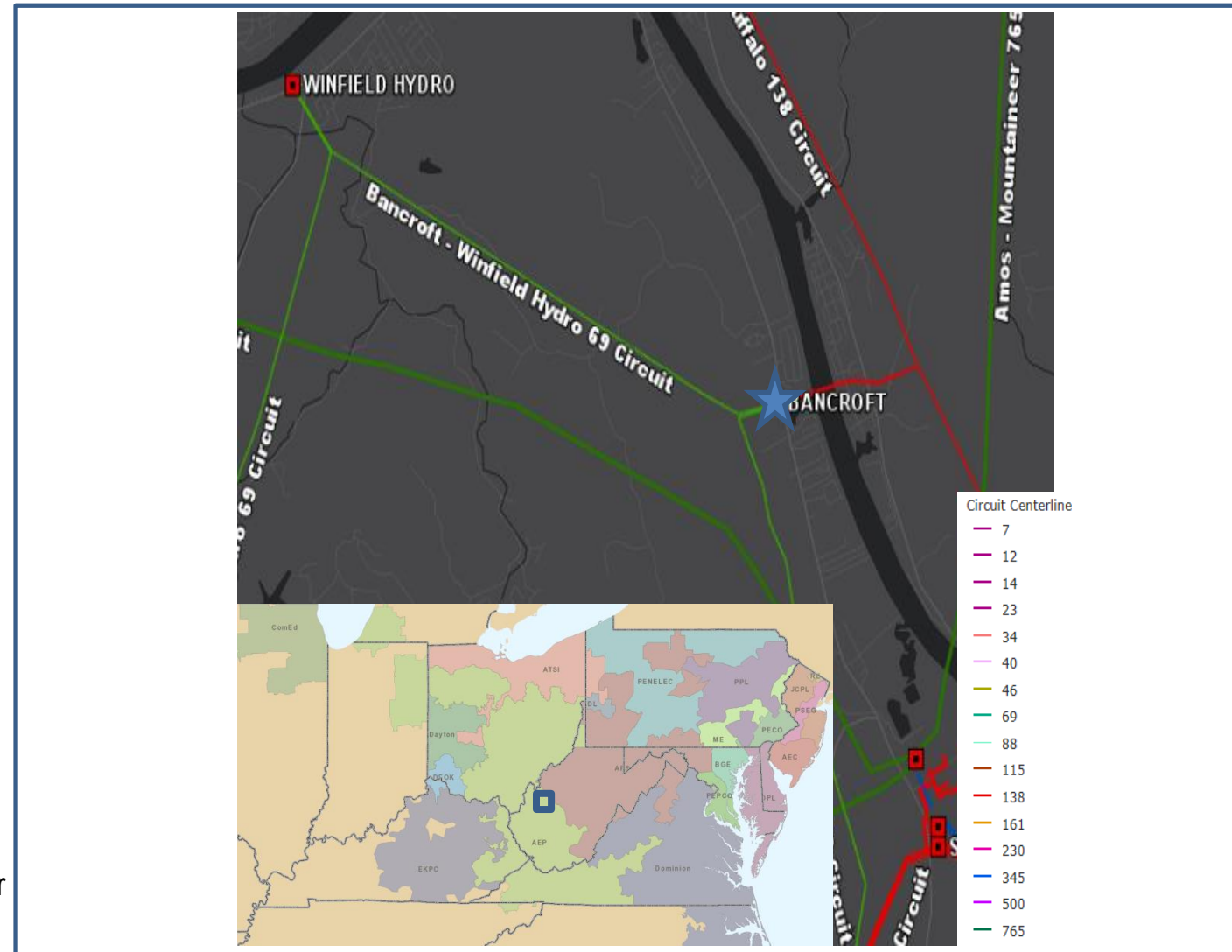

AEP Transmission Zone M-3 Process Bancroft – Turner Rebuild

Need Number: AEP-2019-AP013

Process Stage: Submission of Supplemental Project for inclusion in the Local Plan 02/06/2020

Previously Presented:

- Needs Meeting 6/17/2019
- Solutions Meeting 12/18/2019

Project Driver:

Equipment Condition/Performance/Risk

Specific Assumption Reference:

AEP Guidelines for Transmission Owner Identified Needs (AEP Assumptions Slide 8)

Problem Statement:

Bancroft – Nitro 69 kV (~7.6 miles)

- Majority of the circuit is constructed with 1930s (46/97, 47%) and 1960s (20/97, 21%) wood structures
- The circuit currently has 27 open conditions
 - The conductor is greater than 65 years old, and exceeds the recommended lifespan.
 - Grounding on this line does not meet current standards.
- Between 2015-2018 the circuit experienced 2 momentary and 1 permanent outage resulting in approximately 800k customer minutes of interruption

Nitro – Turner 69 kV (~7.3 miles)

- Over half of the circuit is constructed with 1920s wood structures (51/75 structures, 68%)
- The circuit currently has 60 open conditions
- Approximately half of the line is not shielded.
- From 2015-2018 the circuit has experienced 8 momentary and 6 permanent outages resulting in approximately 130k customer minutes of interruption

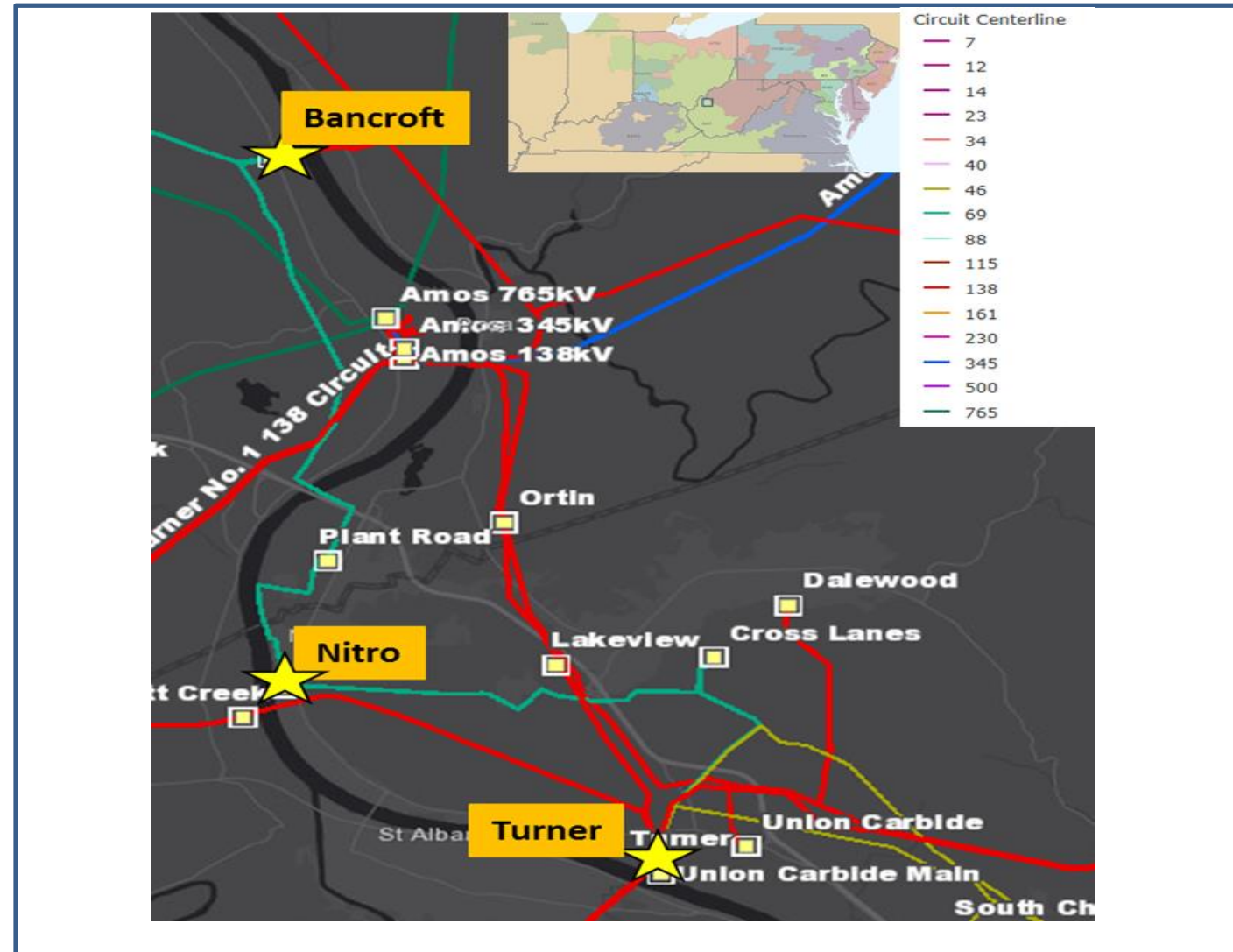

AEP Transmission Zone M-3 Process Bancroft – Turner Rebuild

Need Number: AEP-2019-AP014

Process Stage: Submission of Supplemental Project for inclusion in the Local Plan 02/06/2020

Previously Presented:

Needs Meeting 5/20/2019

Solutions Meeting 12/18/2019

Project Driver:

Equipment Material/Condition/Performance/Risk

Specific Assumption Reference:

AEP Guidelines for Transmission Owner Identified Needs (AEP Assumptions Slide 8)

Problem Statement:

- Turner 46kV CB-O
 - One of only six remaining of the 72EPB-20-12 model on the AEP system.
 - These model types have historically exhibited bad gas leaks, bushing failures, and CT cores getting wet.
 - Since 2015, there have been 25 documented malfunction records on this unit in regards to low SF6 gas levels.
- Turner 138/69 kV Bank #5
 - Recently de-rated due to the loss of a cooling pump that cannot be replaced.
 - This unit could experience an increasing number of overheating events with the potential to cause damage to internal components
 - Moisture content has been rising for a number of years but more severely over the past 11.
 - The rise in moisture content correlates to a significant drop in dielectric strength and rising power factor level for the oil.
 - All three high side bushings are of the Type U design that have extensive manufacturer alerts related to catastrophic failures

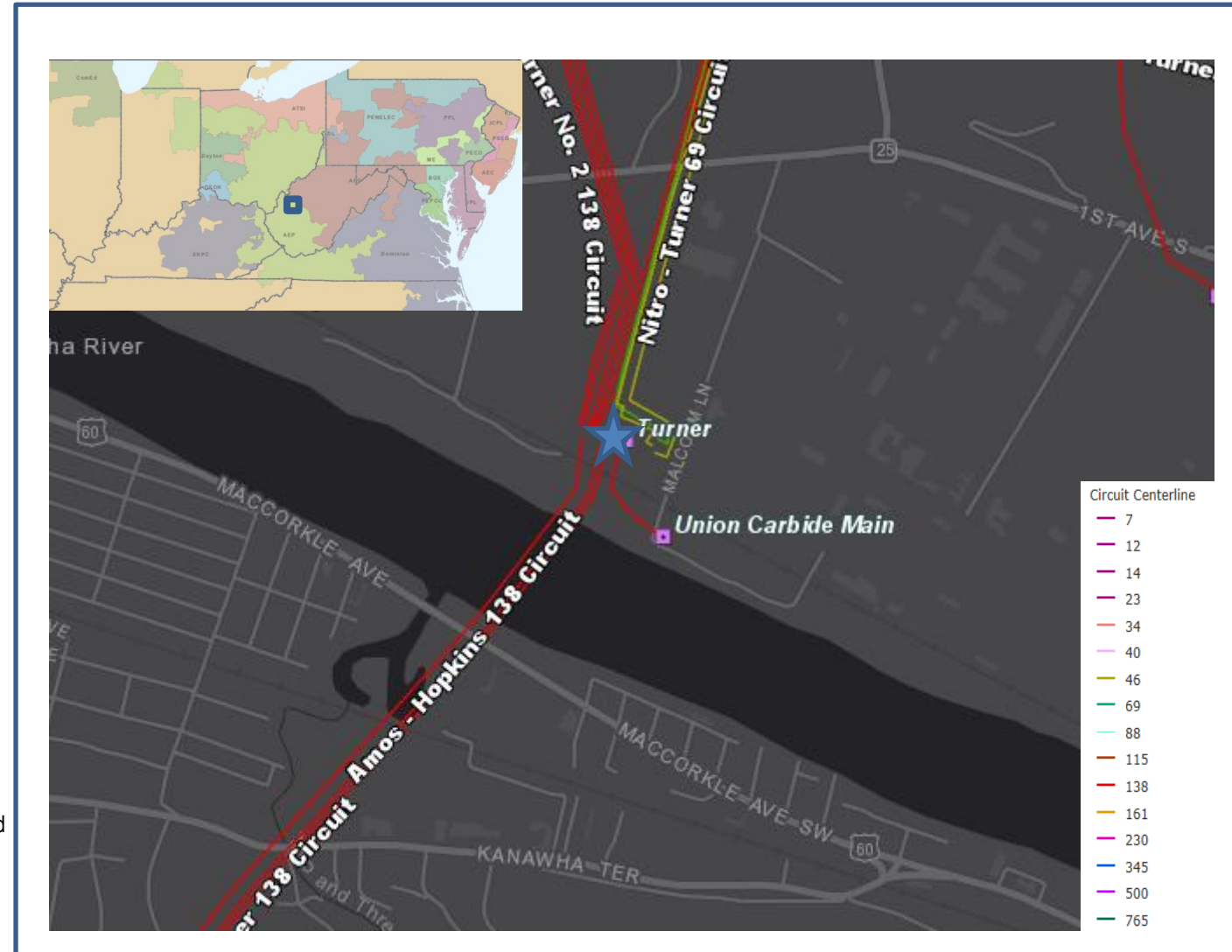

AEP Transmission Zone M-3 Process Bancroft – Turner Rebuild

- Turner GND Bank #7
 - Ethane concentrations in this unit increased drastically in 2018, CO2 levels have increased in 2018 as well. The relative gas concentrations are indicative of numerous overheating events.
 - Decreasing interfacial tension since 2002, this transformer has likely developed sludge in the oil from deteriorating internal components. The presence of this sludge is likely what is impairing proper oil circulation and contributing to the number of overheating events.
 - Increase in moisture levels, correlating with an increased power factor and also indicative of oil degradation.
- The current station configuration has each bank located on a 138kV Bus with only a MOAB on the high side. A transformer fault on any of the transformer banks will cause a momentary outage of one of the 138kV Buses.
- Turner Station Control House
 - Has asbestos and lead paint and existing water leaks.
 - Steps leading up to control house are hazardous to anyone entering station.
- Currently, 61 of the 95 relays (64% of all station relays) are in need of replacement at Turner Station
 - There are 55 of the electromechanical which have significant limitations with regards to fault data collection and retention.
 - There are 5 ABB DPU microprocessor type relays.
 - ABB DPU relays pose a safety risk to persons performing breaker operation because the DPUs are mounted directly on the circuit breaker without a delay for opening and closing the breaker.
 - An additional microprocessor is an RFL that utilizes obsolete firmware and is no longer vendor supported.

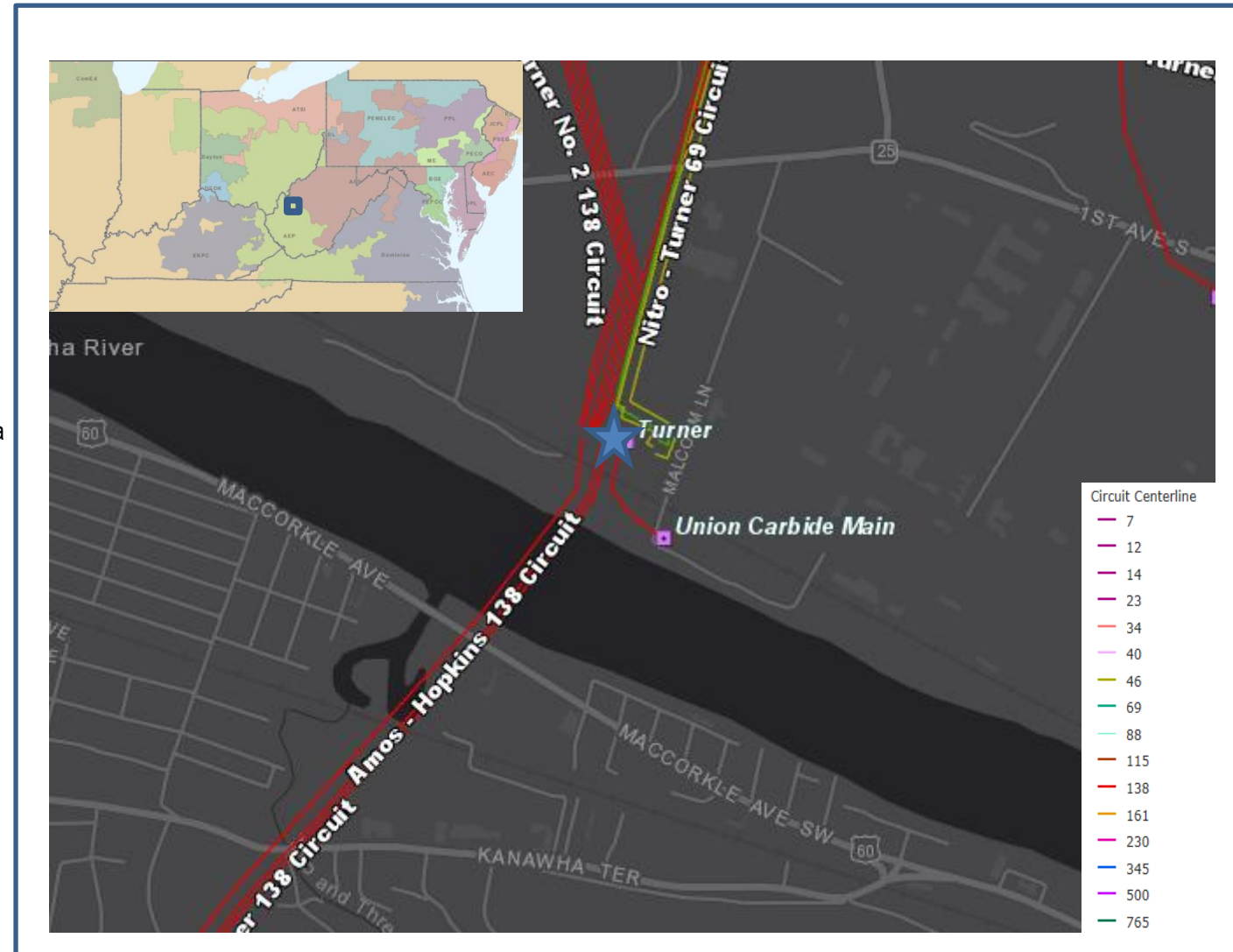

AEP Transmission Zone M-3 Process Bancroft – Turner Rebuild

Need Number: : AEP-2019-AP011, AEP-2019-AP013, AEP-2019-AP014, AEP-2018-AP019

Process Stage: Submission of Supplemental Project for inclusion in the Local Plan 02/06/2020

Selected Solution:

Rebuild the existing Bancroft – Nitro 69kV line (~8.1 miles) to 69kV standards. **(S2165.1) Estimated Cost: \$27.3M**

Rebuild the existing Nitro – Turner 69 kV line, including Cross Lanes Double Ckt. Extension to 69 kV standards (total length ~6.2 miles). **(S2165.2) Estimated Cost: \$24.7M**

Associated line work outside of Turner Station needed to accommodate the Nitro – Turner Rebuild. **(S2165.3) Estimated Cost: \$1.3M**

Bancroft Station: Replace the existing 69 kV circuit breakers G and F with two new 69 kV 3000 A 40 kA circuit breakers, and perform associated remote end relaying work at Winfield Station. DICM is needed at the station to accommodate the new equipment. **(S2165.4) Estimated Cost: \$3.3M**

Nitro Station: Replace existing 69 kV circuit breakers G and H with two new 69 kV 3000 A 40 kA circuit breakers, and perform associated remote end relaying work Turner. **(S2165.5) Estimated Cost: \$2.3M**

Turner Station: Replace 138/69 kV 50 MVA XFR #5 with a new 138/69 kV 90 MVA XFR. Install a new 138 kV 3000 A 40 kA circuit breaker in the F string. Terminate the new 138/69 kV XFR in the F string. Install a new 138 kV 3000 A 40 kA circuit breaker in the E string and terminate XFR #6 in the E string. Replace grounding bank #7. Replace existing 46 kV 1200 A 20 kA CB-O with a new 69 kV 3000 A 40 kA CB (operated at 46 kV). 138/46 kV XFR #6 will be relocated to accommodate the work at the station. Install DICM and upgrade relaying at the station. **(S2165.6) Estimated Cost: \$6.9M**

Total Estimated Cost: \$65.8 M

Projected In-Service: 11/1/2023

Supplemental Project ID: S2165.1-6

Project Status: Scoping

Model: N/A

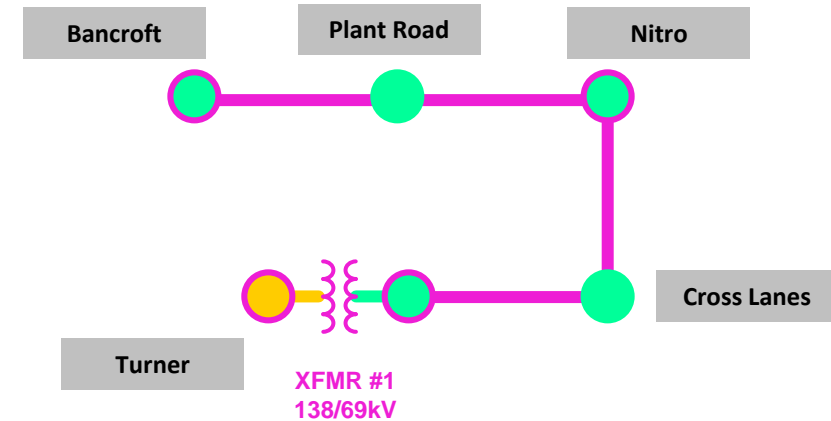

Legend	
345 kV	
138 kV	
69 kV	
46 kV	
New	

AEP Transmission Zone M-3 Process Riverport

Need Number: AEP-2019-AP041

Process Stage: Submission of Supplemental Project for inclusion in the Local Plan 02/06/2020

Previously Presented:

Needs Meeting 10/25/2019

Solutions Meeting 12/18/2019

Project Driver:

Customer Service

Specific Assumption Reference:

AEP Connection Requirements for the AEP Transmission System (AEP Assumptions Slide 7)

Problem Statement:

Eastman Chemical in coordination with Air Products, has requested a new point of service for their planned new facilities at Moreland Drive. The projected peak demand of 47 MW for service to Eastman Chemical.

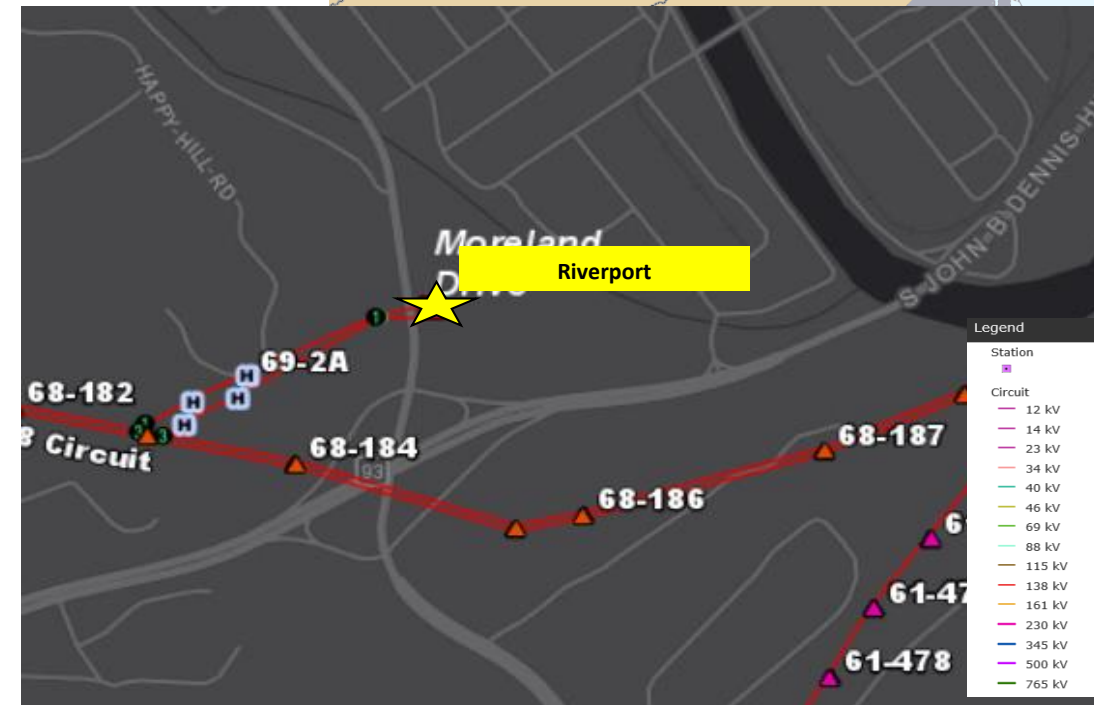
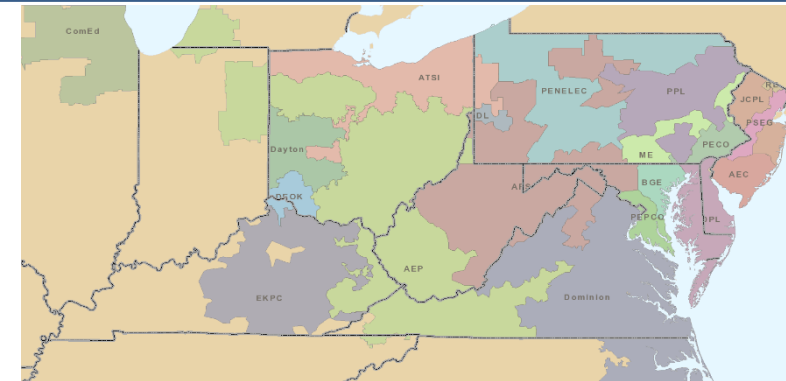

Need Number: AEP-2019-AP041

Process Stage: Submission of Supplemental Project for inclusion in the Local Plan 02/06/2020

Selected Solution:

Construct a new 138kV station in a four breaker ring bus utilizing four 138kV 3000A 40kA breakers and 138kV metering to the Eastman facilities. Construct a double circuit line (~0.2 miles) to the new Riverport station by tapping both the Clinch River – Moreland Drive 138kV and Holston – Moreland Drive 138kV circuits off of the Air Products Loop 138kV asset.

(S2151)

Estimated Cost: \$10.5 M

Projected In-Service: 12/1/2020

Supplemental Project ID: S2151

Project Status: Scoping

Model: 2024 RTEP

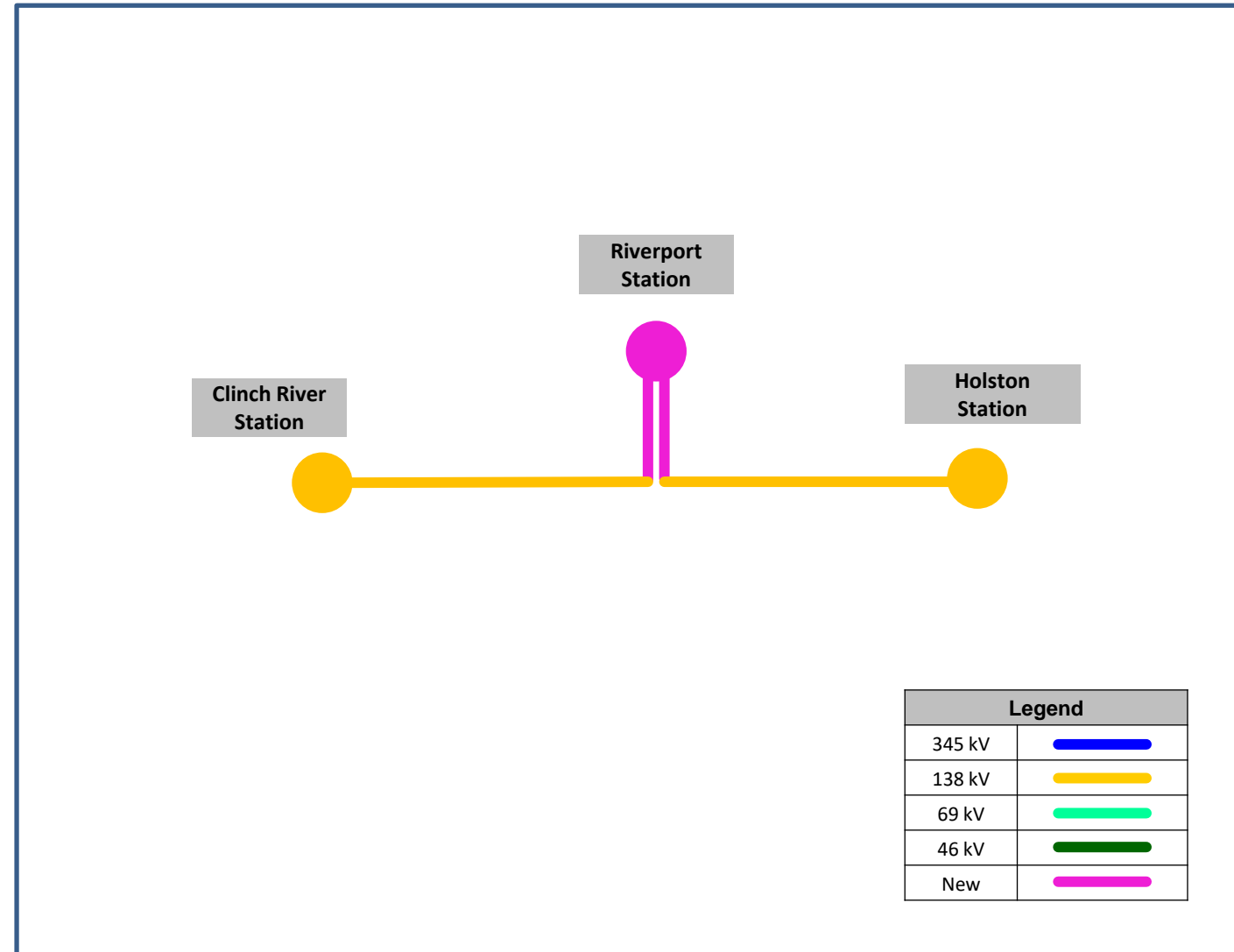

AEP Transmission Zone M-3 Process Niles Area Improvements

Need Number: AEP-2018-IM002

Process Stage: Submission of Supplemental Project for inclusion in the Local Plan 02/06/2020

Previously Presented:

Needs Meeting 10/26/2018

Solutions Meeting 12/18/2019

Project Driver:

Equipment Condition/Performance/Risk

Specific Assumption Reference:

AEP Guidelines for Transmission Owner Identified Needs (AEP Assumptions Slide 8)

Problem Statement:

The Pokagon Station

- CBs J, E, and H are oil filled breakers without oil containment
- Fault operations: CB E(28), CB H(61) - Recommended (10)

Lake Street Station

- CBs A and H are oil filled breakers without oil containment
- CB H is a GE FK type which are known to fail violently
- Fault operations: CB A(24), CB H(13) – Recommended (10)
- Transformer 1 – 1969 vintage
 - CO2 IEEE level 3
 - Moisture level high and rising
 - Wood tie supports

Niles Station

- CBs A, B, M, and N are oil filled breakers without oil containment
- CB M and CB N are GE FK type which are known to fail violently
- Fault operations: CB A(30), CB B(42), CB N(21) – Recommended (10)
- Transformer 2 – 1969 vintage
 - CO2 IEEE level 3
 - Moisture level high and rising
 - Wood tie supports

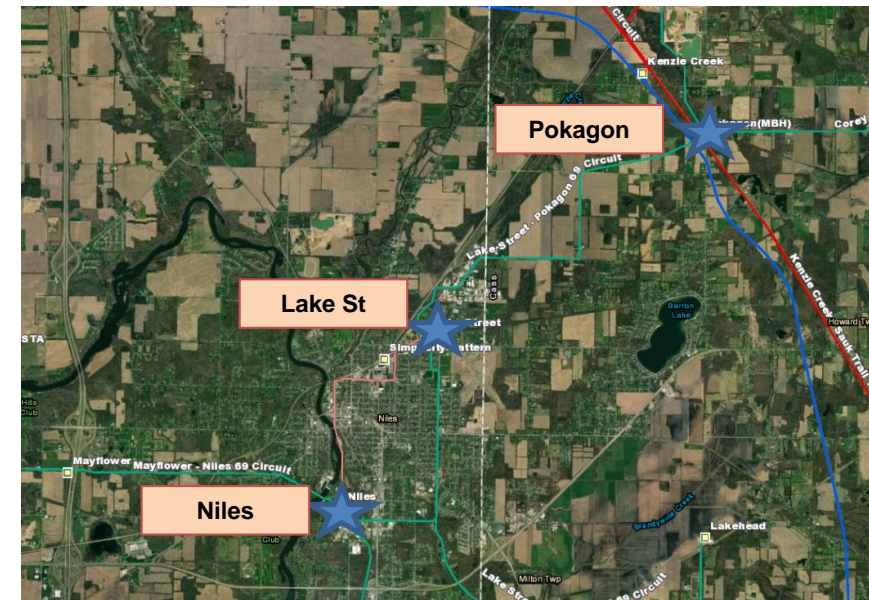

AEP Transmission Zone M-3 Process Niles Area Improvements

Need Number: AEP-2018-IM002

Process Stage: Submission of Supplemental Project for inclusion in the Local Plan 02/06/2020

Previously Presented:

Needs Meeting 10/26/2018

Solutions Meeting 12/18/2019

Project Driver:

Equipment Condition/Performance/Risk

Specific Assumption Reference:

AEP Guidelines for Transmission Owner Identified Needs (AEP Assumptions Slide 8)

Problem Statement:

Lake Street – Niles 69kV circuit

- 1960's wood cross arm construction
- Poor shielding condition
- Lakehead Pumping Tap has open conditions on 30% of structures
- Total open conditions – 54

Lake Street – Niles 34.5kV circuit

- 1965 wood pole construction
- Total open conditions – 51
- 40% of structures with open conditions
- 97% of line original wood poles
- Wooden cross arm with cap and pin insulator construction
- No shield wire

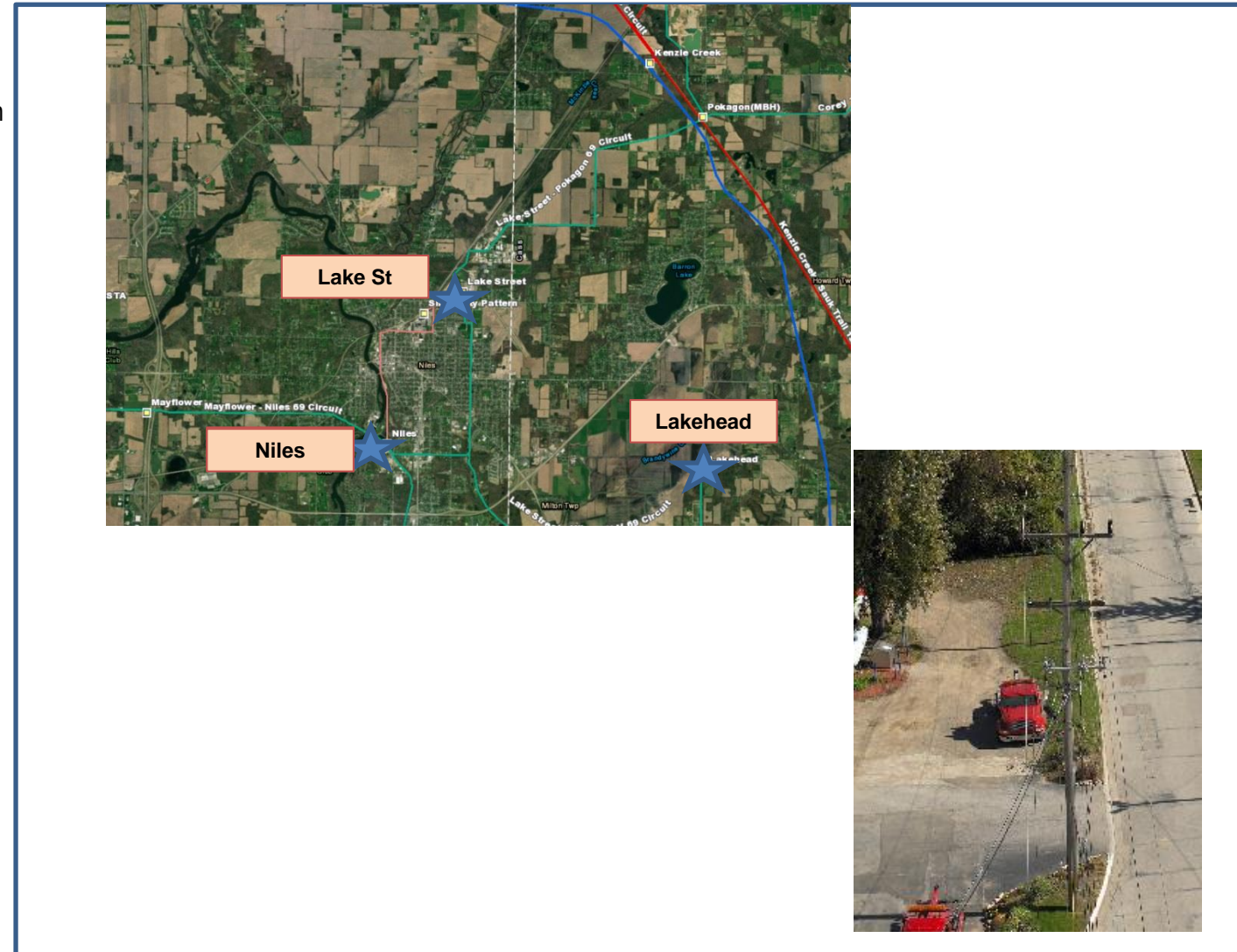

AEP Transmission Zone M-3 Process Niles Area Improvements

Need Number: AEP-2019-IM035

Process Stage: Submission of Supplemental Project for inclusion in the Local Plan 02/06/2020

Previously Presented:

Needs Meeting 08/29/2019

Solutions Meeting 12/18/2019

Project Driver:

Equipment Material/Condition/Performance/Risk

Specific Assumption Reference:

AEP Guidelines for Transmission Owner Identified Needs (AEP Assumptions Slide 8)

Problem Statement:

South Bend – Niles 69kV Line (~11.47 Miles)

- 1968 vintage wood pole construction
- Forced Momentary outages: 5
- Forced Permanent outages: 3
- Total structure related open conditions – 47
- Unique structure count with open conditions – 44
- Insect Damage, Rotten Poles, Broken/Burnt cross-arm, Woodpecker holes, broken/burnt insulators, stolen/broken ground wires, broken guy strain insulators and cracked stub pole.
- More than three in-line sectionalizing MOABS

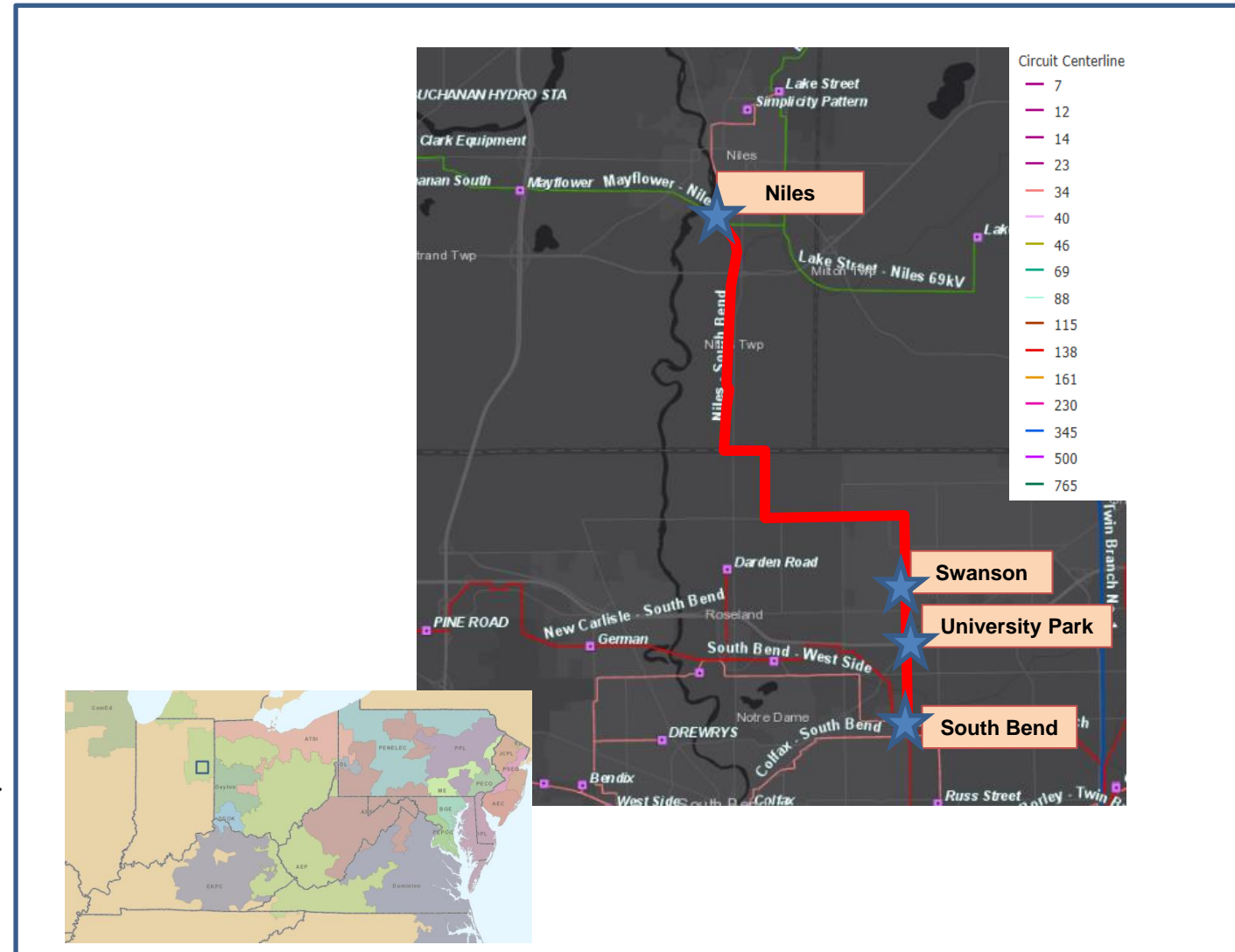

AEP Transmission Zone M-3 Process Niles Area Improvements

Need Number: AEP-2019-IM025

Process Stage: Submission of Supplemental Project for inclusion in the Local Plan 02/06/2020

Previously Presented:

Needs Meeting 10/25/2019

Solutions Meeting 12/18/2019

Project Driver:

Equipment Material/Condition/Performance/Risk

Specific Assumption Reference:

AEP Guidelines for Transmission Owner Identified Needs (AEP Assumptions Slide 8)

Problem Statement:

Pokagon – Lake Street 69kV line (4.9 miles)

- 28 open conditions
- 1952 wood cross-arm construction
- Many weather related failures/outages
- 12 momentary outages over the last 10 years

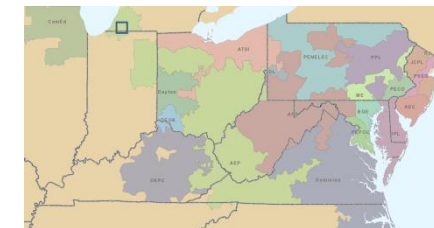
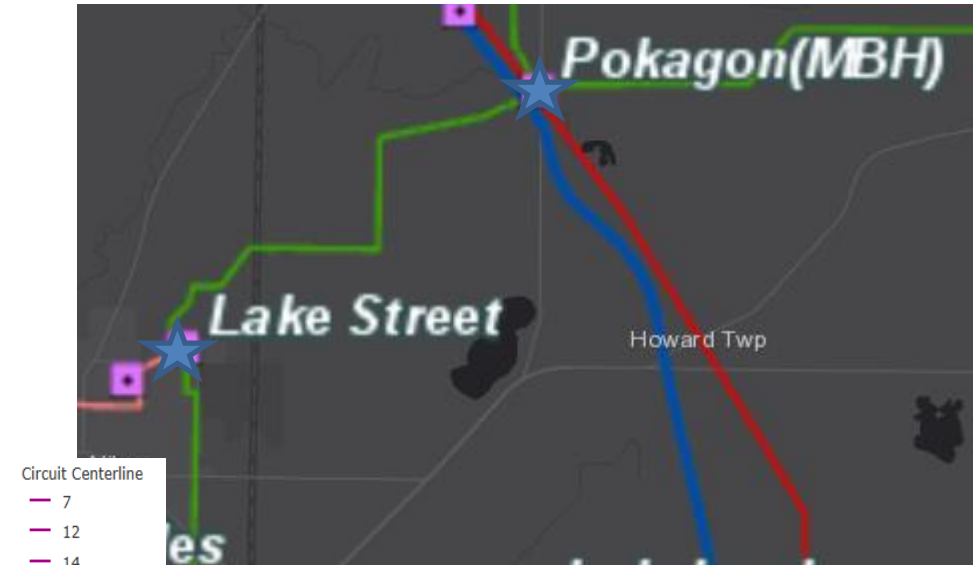

AEP Transmission Zone M-3 Process Niles Area Improvements

Need Number: AEP-2019-IM046

Process Stage: Submission of Supplemental Project for inclusion in the Local Plan 02/06/2020

Previously Presented:

Needs Meeting 11/22/2018

Solutions Meeting 12/18/2019

Project Driver:

Equipment Condition/Performance/Risk

Specific Assumption Reference:

AEP Guidelines for Transmission Owner Identified Needs (AEP Assumptions Slide 8)

Problem Statement:

Lake Street 69/34.5kV station

- New load delivery point which will serve ~8MW.

South Bend – Niles 69kV line

- New load delivery point which will serve ~15MW.

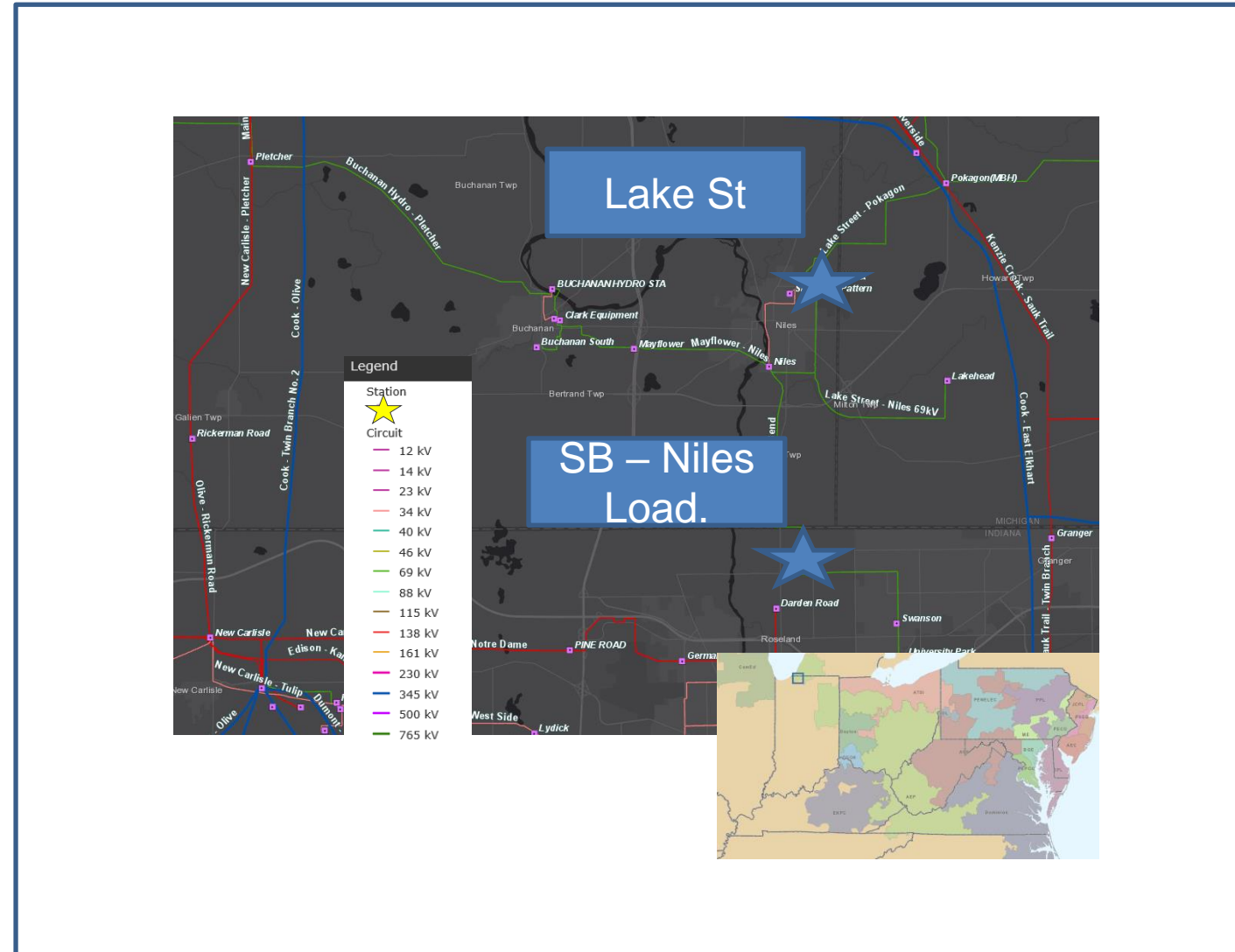

AEP Transmission Zone M-3 Process Niles Area Improvements

Need Number: AEP-2018-IM002, AEP-2019-IM035, AEP-0219-IM025, AEP-2019-IM046

Process Stage: Submission of Supplemental Project for inclusion in the Local Plan 02/06/2020

Selected Solution:

At Kenzie Creek station, install a 138/69kV XFR, 3 138kV breakers, 5 69kV breakers and a 14.4Mvar cap bank to allow for the retirement of Pokagon’s 69 kV transmission yard. **(S2167.1)**

Estimated Cost: \$12M

At Pokagon station, retire the 69kV voltage class and re-organize this station as a 138/12kV station only. **(S2167.2)**

Estimated Cost: \$2M

At Lake Street station, install a new 69/12kV load delivery point, replace XFR 1 with a 50MVA bank, and replace 34.5kV CB “H” and 69kV Breaker “A” **(S2167.3)**

Estimated Cost: \$7.8M

At Niles station, replace 69kV breakers “B” and “A”. Replace XFR 2 and the breaker toward the City of Niles **(S2167.4)**

Estimated Cost: \$6.2M

Route the Dailey, Barret and Lake St 69kV lines into Kenzie Creek station. **(S2167.5)**

Estimated Cost: \$2.8

Build the new 138/69/34kV Boundary station to serve the new 34.5kV distribution load and to separate the Swanson and University Park load form the network. **(S2167.6)**

Estimated Cost: \$13.6M

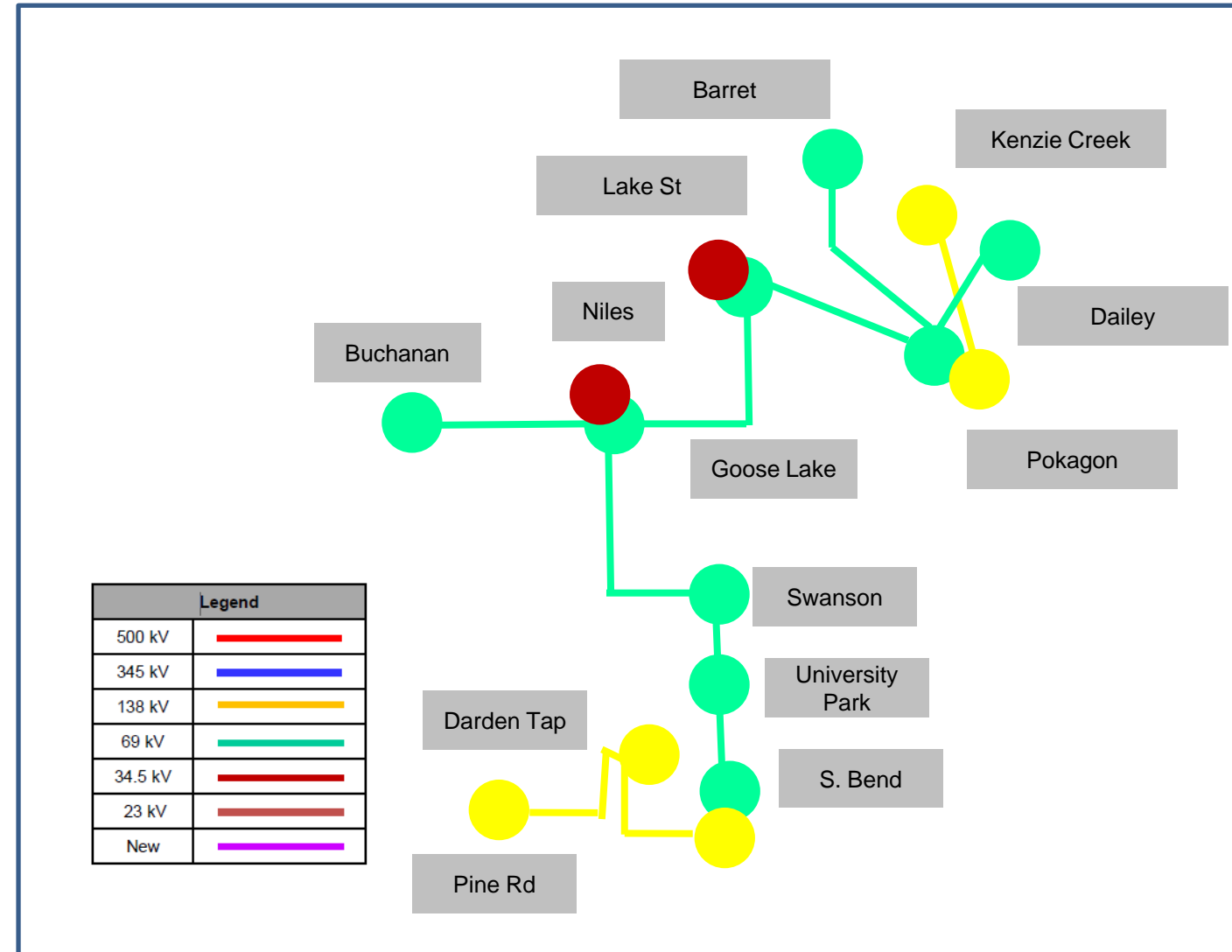

AEP Transmission Zone M-3 Process McKinley Area Improvements

Need Number: AEP-2019-IM018

Process Stage: Submission of Supplemental Project for inclusion in the Local Plan 02/06/2020

Previously Presented:

Needs Meeting 11/22/2019

Solutions Meeting 12/18/2019

Project Driver:

Equipment Material/Condition/Performance/Risk

Specific Assumption Reference:

AEP Guidelines for Transmission Owner Identified Needs (AEP Assumptions Slide 8)

Problem Statement:

1. McKinley – General Electric Taylor West 34kV Line (~0.9 Miles)
 - 1956 vintage wood pole, crossarm construction
 - There are currently 9 open conditions on this line.
 - Open conditions include: Damaged and rotted structures, stolen ground lead wires and broken knee/vee brace.

2. McKinley – Slater Steel 34kV Line (~0.98 Miles)
 - 1967 vintage wood pole, crossarm construction
 - There are currently 4 open conditions on this line.
 - Open conditions include: Broken, missing, or stolen ground lead wires.

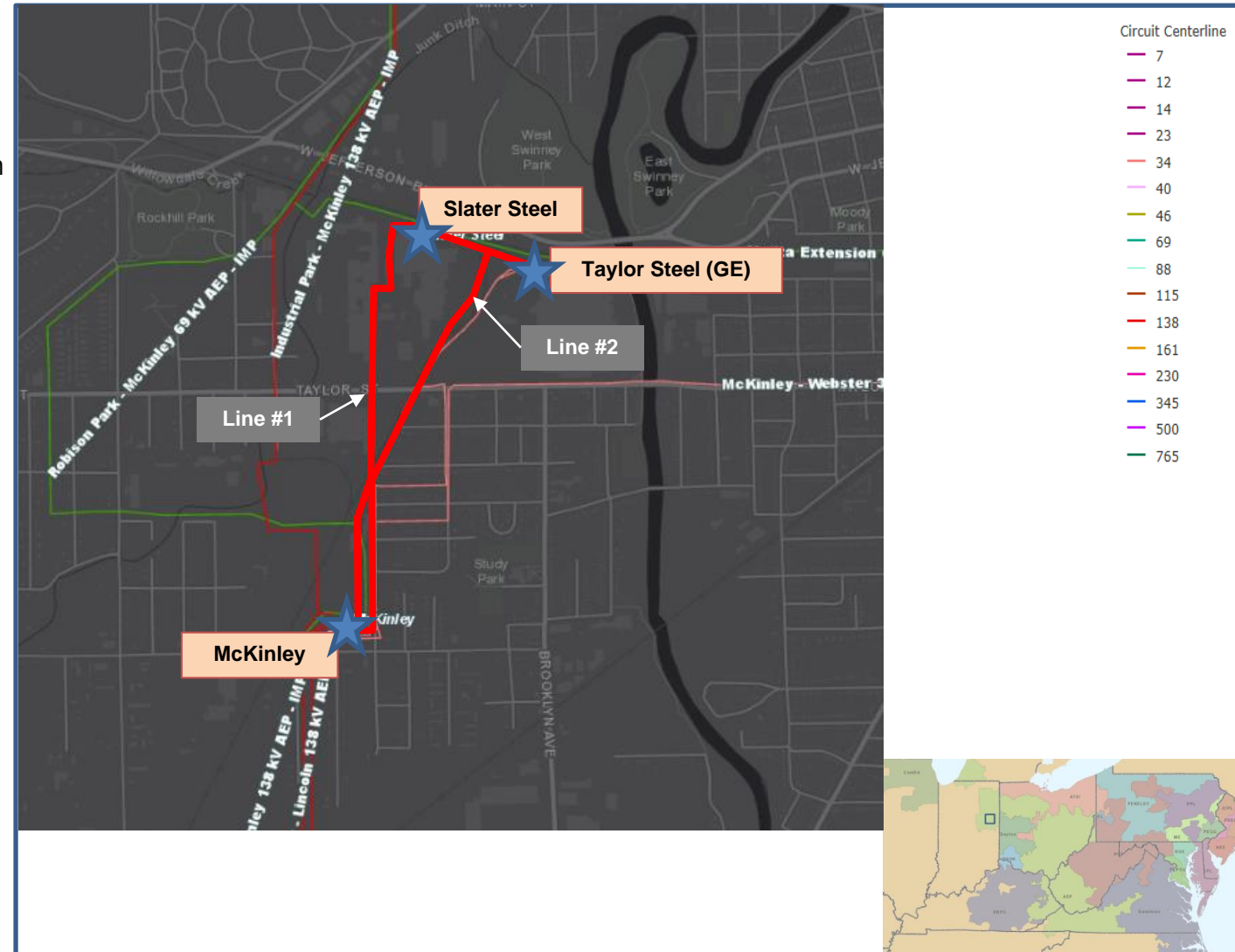

AEP Transmission Zone M-3 Process McKinley Area Improvements

Need Number: AEP-2019-IM018

Process Stage: Submission of Supplemental Project for inclusion in the Local Plan 02/06/2020

Previously Presented:

Needs Meeting 11/22/2019

Solutions Meeting 12/18/2019

Project Driver:

Equipment Material/Condition/Performance/Risk

Specific Assumption Reference:

AEP Guidelines for Transmission Owner Identified Needs (AEP Assumptions Slide 8)

Problem Statement:

1. McKinley – Taylor General Electric Line 34kV Line (~0.9 Miles)
 - 1956 vintage wood pole, crossarm construction
 - There are currently 3 open conditions on this line.
 - Open conditions include: Split pole and stolen ground lead wires.

2. McKinley – General Electric Taylor East 34kV Line (~0.7 Miles)
 - 1960 vintage wood pole, crossarm construction
 - There are currently 9 open conditions on this line.
 - Open conditions include: Damaged, split or rotted structures.

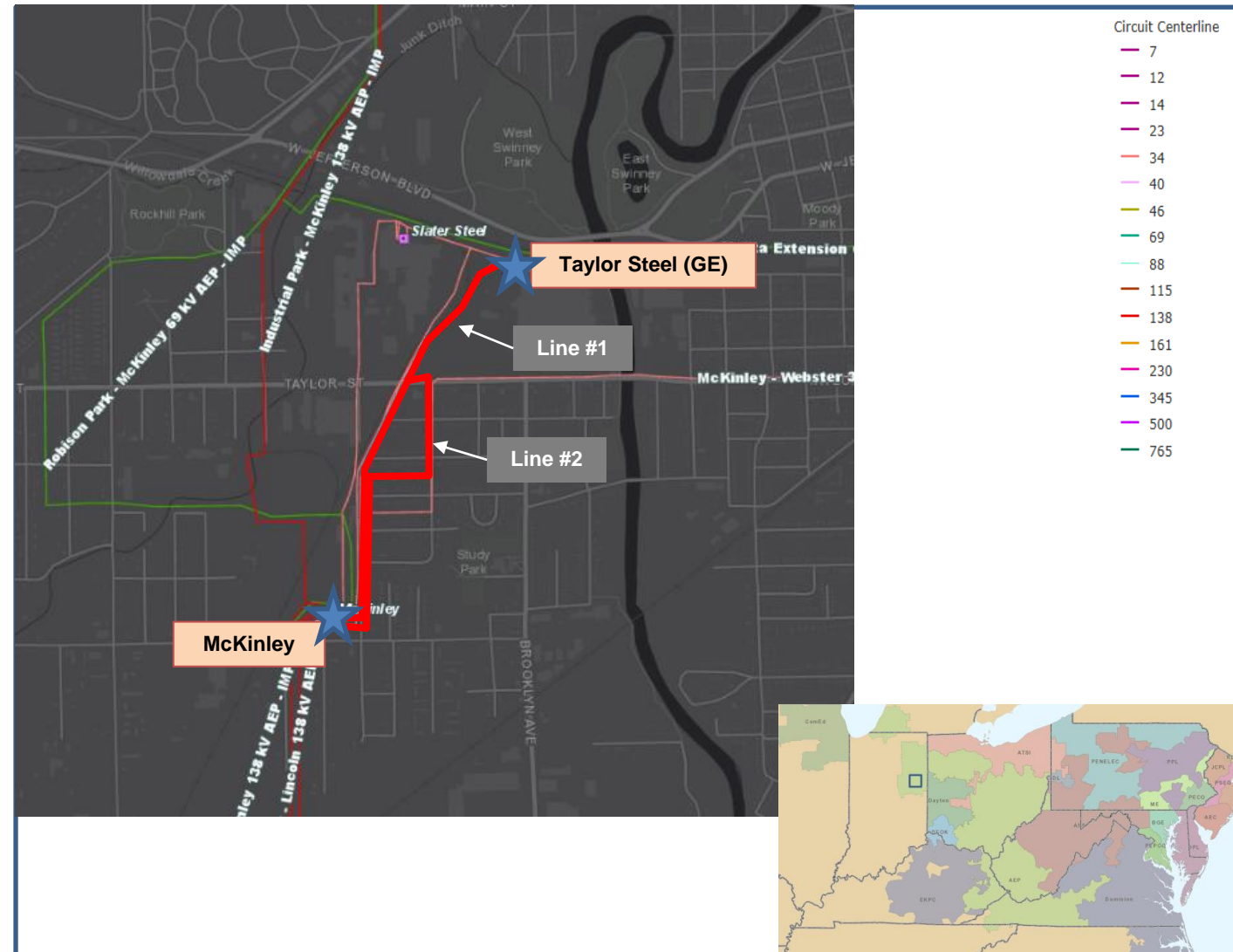

AEP Transmission Zone M-3 Process McKinley Area Improvements

Need Number: AEP-2019-IM018

Process Stage: Submission of Supplemental Project for inclusion in the Local Plan 02/06/2020

Previously Presented:

Needs Meeting 11/22/2019

Solutions Meeting 12/18/2019

Project Driver:

Equipment Material/Condition/Performance/Risk

Specific Assumption Reference:

AEP Guidelines for Transmission Owner Identified Needs (AEP Assumptions Slide 8)

Problem Statement:

1. Bass – McKinley 34.5kV (~3.5 Miles)

- 1930 vintage steel single circuit lattice construction.
- There are currently 4 open conditions on this line.
- Six wired Copper conductor with copper weld shield wire. Copper conductors become brittle with age and Copper weld conductor has long been obsolete

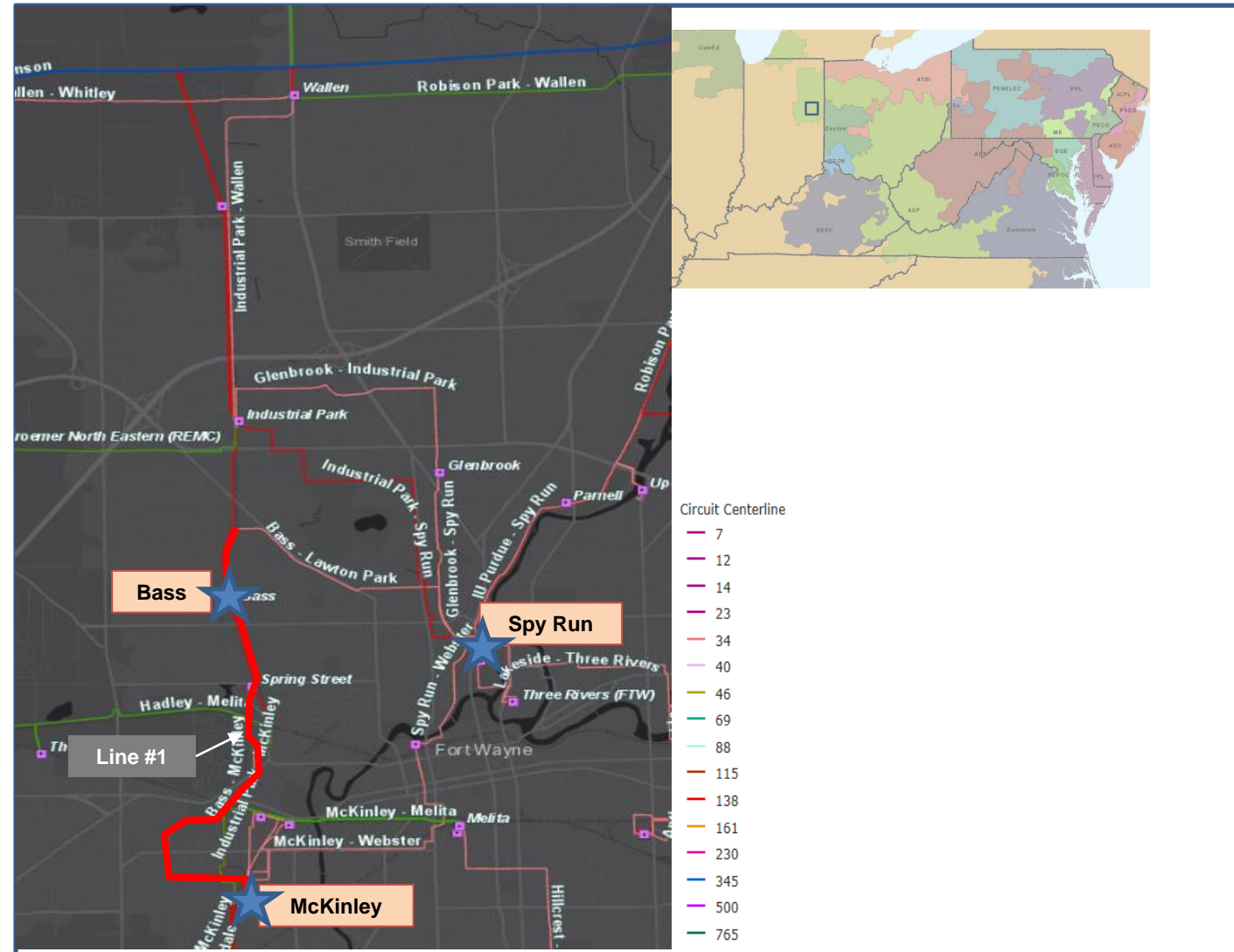

AEP Transmission Zone M-3 Process McKinley Area Improvements

Need Number: AEP-2019-IM018

Process Stage: Submission of Supplemental Project for inclusion in the Local Plan
02/06/2020

Previously Presented:

Needs Meeting 11/22/2019

Solutions Meeting 12/18/2019

Project Driver:

Equipment Material/Condition/Performance/Risk

Specific Assumption Reference:

AEP Guidelines for Transmission Owner Identified Needs (AEP Assumptions Slide 8)

Problem Statement:

McKinley 138/69/34.5kV station

- Breakers F,J,K & M 34kV
 - 1956 vintage FK Oil breakers which have been known to fail violently.
- Breaker DD 34kV
 - 1962 vintage FK Oil breakers which have been known to fail violently.
- Oil filled breakers have much more maintenance required due to oil handling that their modern, vacuum counterparts do not require. Finding spare parts for these units is difficult or impossible, and these models are no longer vendor supported

Slater Steel 34kV station

- Unmaintained customer-owned 34 kV switching facilities inside Slater Steel Station.
- Concerns about employees safety while switching in the customer station

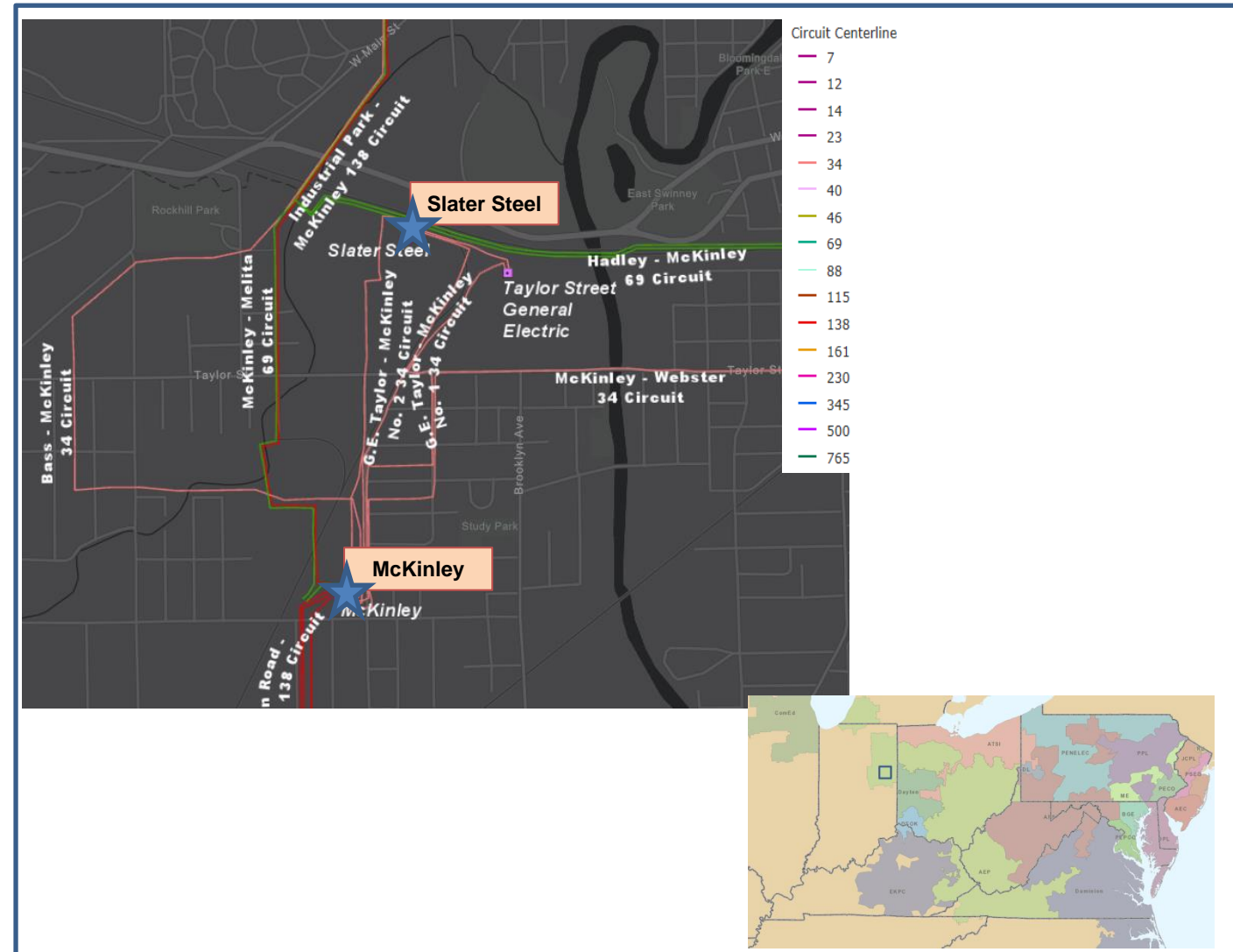

AEP Transmission Zone M-3 Process McKinley Area Improvements

Need Number: AEP-2019-IM018

Process Stage: Submission of Supplemental Project for inclusion in the Local Plan 02/06/2020

Selected Solution:

Slater Steel & GE Taylor 34.5kV Feeds:

Retire the McKinley – General Electric Taylor West 34kV Line; McKinley – Slater Steel 34kV Line; McKinley – Taylor General Electric 34kV Line and the McKinley – General Electric Taylor East 34kV and in their place build a single ~1 mile 34.5kV feed from McKinley – Slater Steel. As a note, the customer has retired their GE Taylor station so it no longer requires a feed. **(S2152.1)**

Estimated Cost: \$2.8M

McKinley – Spy Run 34.5kV:

Rebuild approximately 4.5 miles of the McKinley – Spy Run circuit, including a line section approximately 2.7 miles long to feed Slater Steel station. **(S2152.2)**

Estimated Cost: \$6.7M

Wall Street 34.5kV station:

Install a new PoP switch to feed Slater Steel station. **(S2152.3)**

Estimated Cost: \$.5M

McKinley 138/69/34.5kV station:

Retire 34.5kV CB's "J", "M", "F", "K", and "DD". Consolidate the 34.5kV voltage class into a single bus and relocate the 69kV line exit into the station yard. Install a high side circuit switcher. **(S2152.4)**

Estimated Cost: \$3.7M

Estimated Cost: \$13.6 M

Projected In-Service: 5/16/2022

Supplemental Project ID: S2152.1-4

Project Status: Scoping

Model: N/A

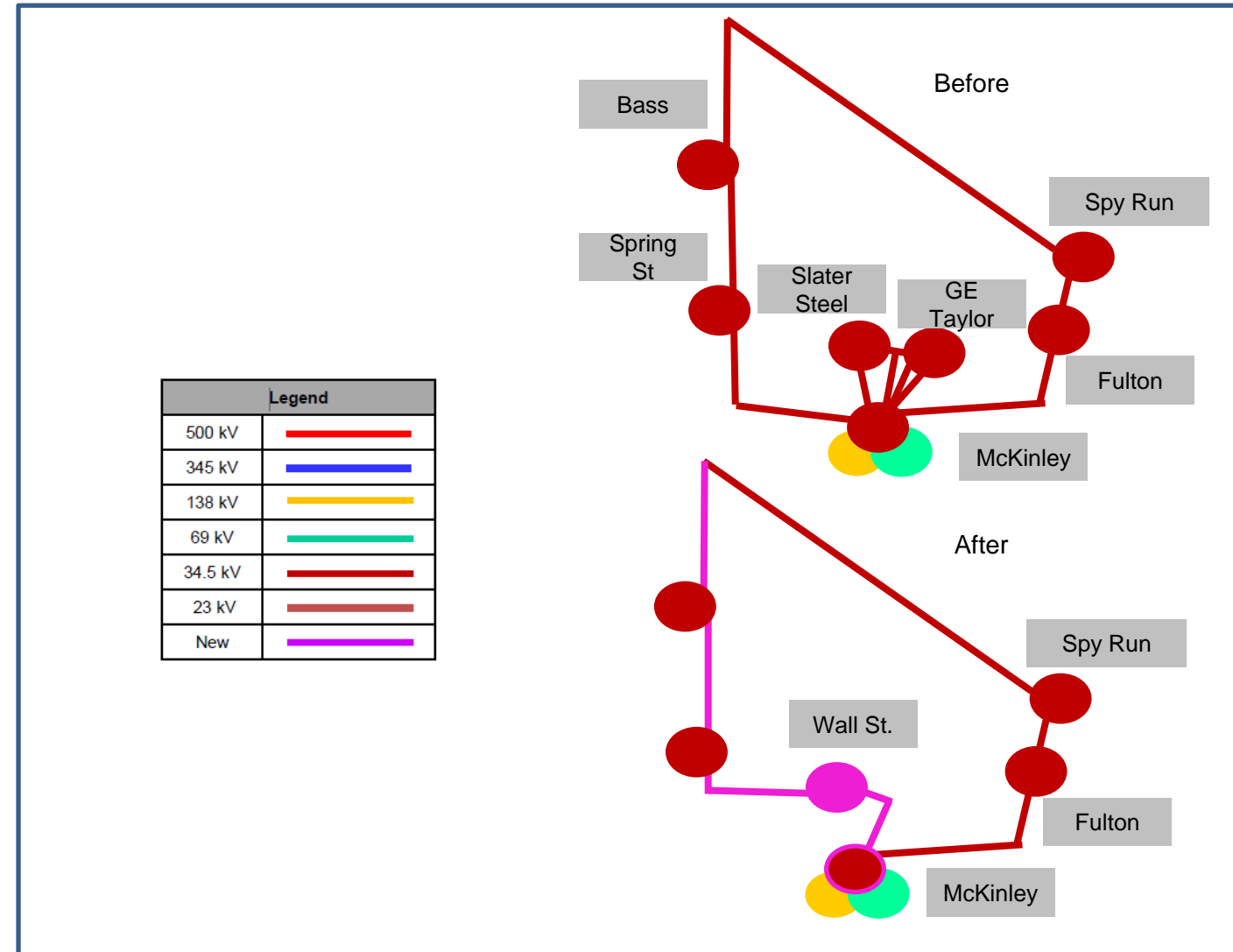

AEP Transmission Zone M-3 Process Hillcrest – Adams 69kV Rebuild

Need Number: AEP-2019-IM030

Process Stage: Submission of Supplemental Project for inclusion in the Local Plan
02/06/2020

Previously Presented:

Needs Meeting 02/20/2019

Solutions Meeting 12/18/2019

Project Driver:

Equipment Condition/Performance/Risk

Specific Assumption Reference:

AEP Guidelines for Transmission Owner Identified Needs (AEP Assumptions Slide 8)

Problem Statement:

Hillcrest – Bluffton 69kV line

- 1964 vintage wood pole line
- This line is currently subject to 155 open conditions with the majority being structural issues. This trend is expected to increase as the structures and conductor age.

Adams – Bluffton 69kV line

- 1957 vintage wood pole line
- This line is currently subject to 32 open conditions with the majority being rotting structural issues. This trend is expected to increase as the structures and conductor age.

Kingsland 69kV station

- Breakers “A” and “B”
 - 1969 vintage Oil breaker
 - Fault Operations: A(31) B(27) – Recommended(10)

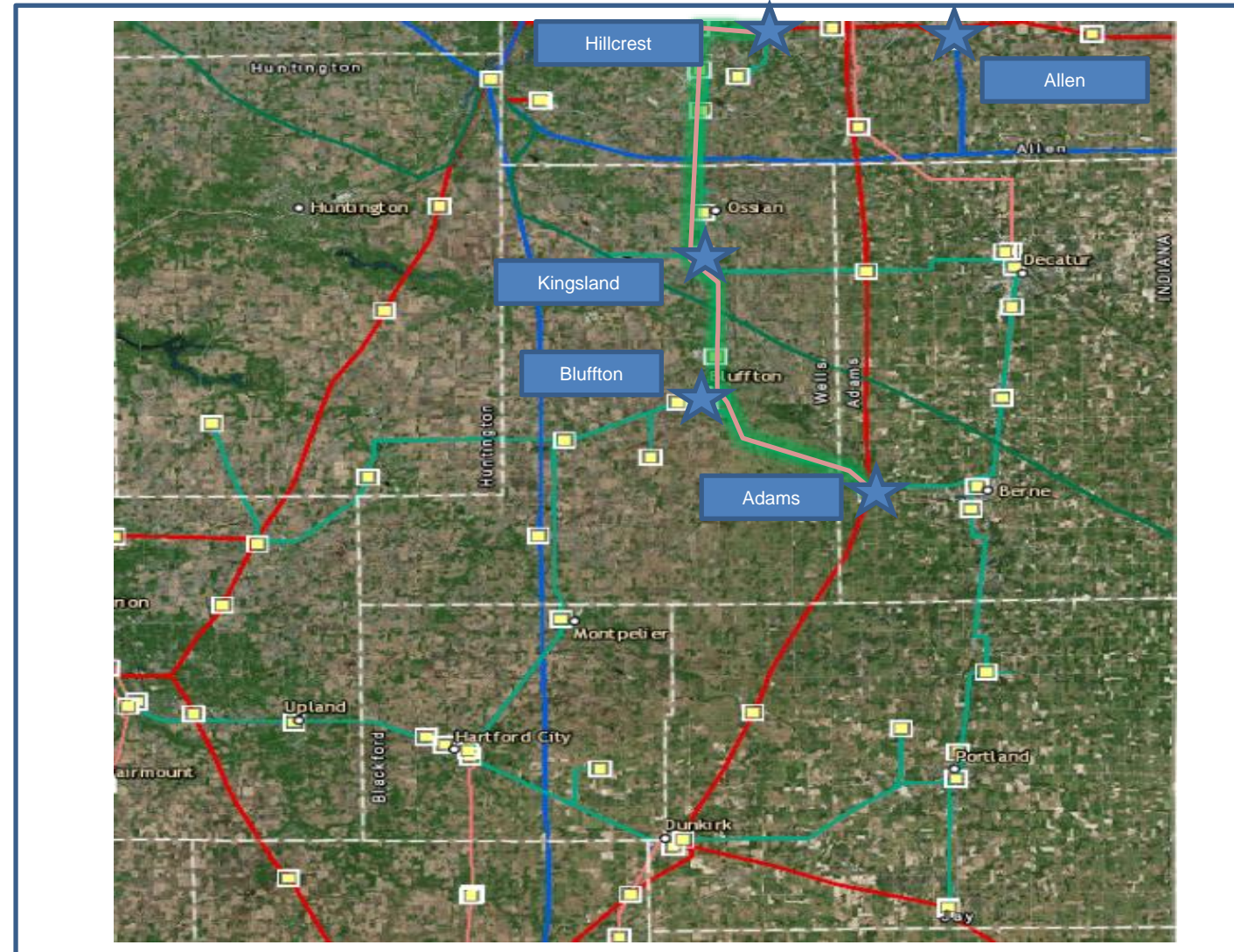

AEP Transmission Zone M-3 Process Hillcrest – Adams 69kV Rebuild

Need Number: AEP-2019-IM030

Process Stage: Submission of Supplemental Project for inclusion in the Local Plan 02/06/2020

Previously Presented:

Needs Meeting 02/20/2019

Solutions Meeting 12/18/2019

Project Driver:

Equipment Condition/Performance/Risk

Specific Assumption Reference:

AEP Guidelines for Transmission Owner Identified Needs (AEP Assumptions Slide 8)

Problem Statement:

WVPA/Heartland Industrial Park 1 (Pleasant station)

- WVPA/Heartland has requested a new 138kV delivery point to feed a new industrial park.
- 2 industrial customers are already building on this site with room for further expansion. This load growth further constrains an already constrained 69kV network

WVPA/Heartland Industrial Park 2 (Ossian station)

- WVPA/Heartland has target this area for industrial development.
- Potential economic developments have not materialized due to system load limitations.

Kinnerk (WVPA/Heartland station)

- Customer has made an offer to upgrade this station to 138kV in order to enable to connect 138kV to the Pleasant and Ossian industrial parks.

Kingsland (I&M Distribution)

- I&M Distribution has indicated a want to move toward 138kV at this facility due to the expected load growth in the industrial park north of this station.

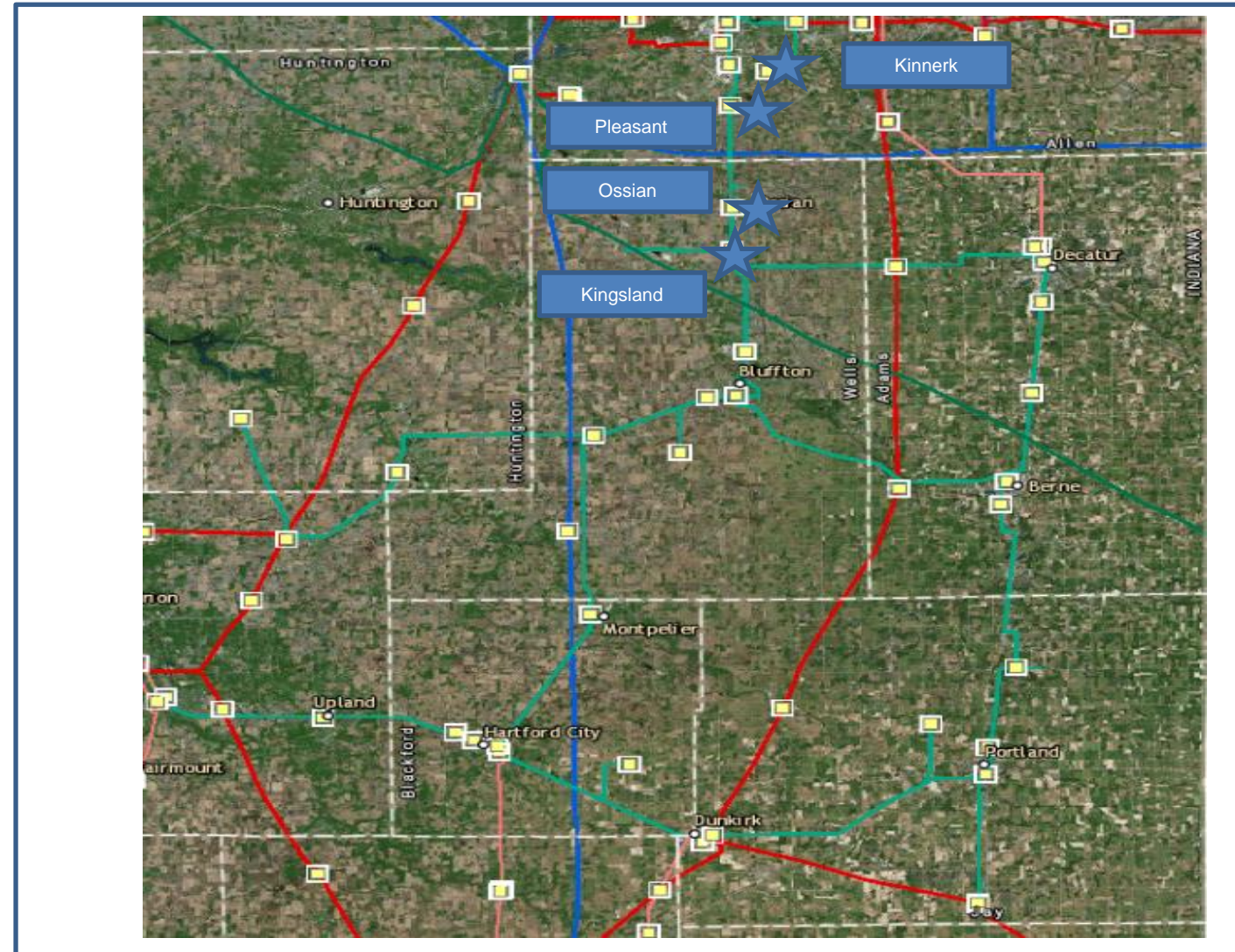

AEP Transmission Zone M-3 Process Hillcrest – Adams 69kV Rebuild

Need Number: AEP-2019-IM030

Process Stage: Submission of Supplemental Project for inclusion in the Local Plan 02/06/2020

Selected Solution:

Rebuild the ~9.5 miles of the Kingsland – Bluffton – Adams circuit as 6-wired 138kV design structures. **(S2153.1) Estimated Cost: \$28.5M**

Build ~4.5 mile greenfield from Uniondale station to Ossian station. **(S2153.2) Estimated Cost: \$8M**

Rebuild the Bluffton – Hillcrest 69kV line as the ~26 mile Bluffton to Pleasant circuit as 6-wired 138kV design structures. **(S2153.3) Estimated Cost: \$67.1M**

Build the ~3.3 mile Pleasant to Kinnerk circuit as 6-wired 138kV design structures. **(S2153.4) Estimated Cost: \$9.6M**

Install one 138kV rated POP switch to feed Kinnerk’s load. **(S2153.5) Estimated Cost: \$0.4M**

Replace 2 69kV CB’s toward Bluffton and Pleasant at Kingsland. **(S2153.6) Estimated Cost: \$1.6M**

Install the new 69kV switch called Skips Place to feed the Uniondale load. **(S2153.7) Estimated Cost: \$0.3M**

Install 69kV switch called Thiele to feed Kinnerk load. **(S2153.8) Estimated Cost: \$0.6M**

Remove CB “F” at Hillcrest station. **(S2153.9) Estimated Cost: \$0.1M**

Estimated Cost: \$116.2 M

Projected In-Service: 10/01/2023

Supplemental Project ID: S2153.1-9

Project Status: Scoping

Model: N/A

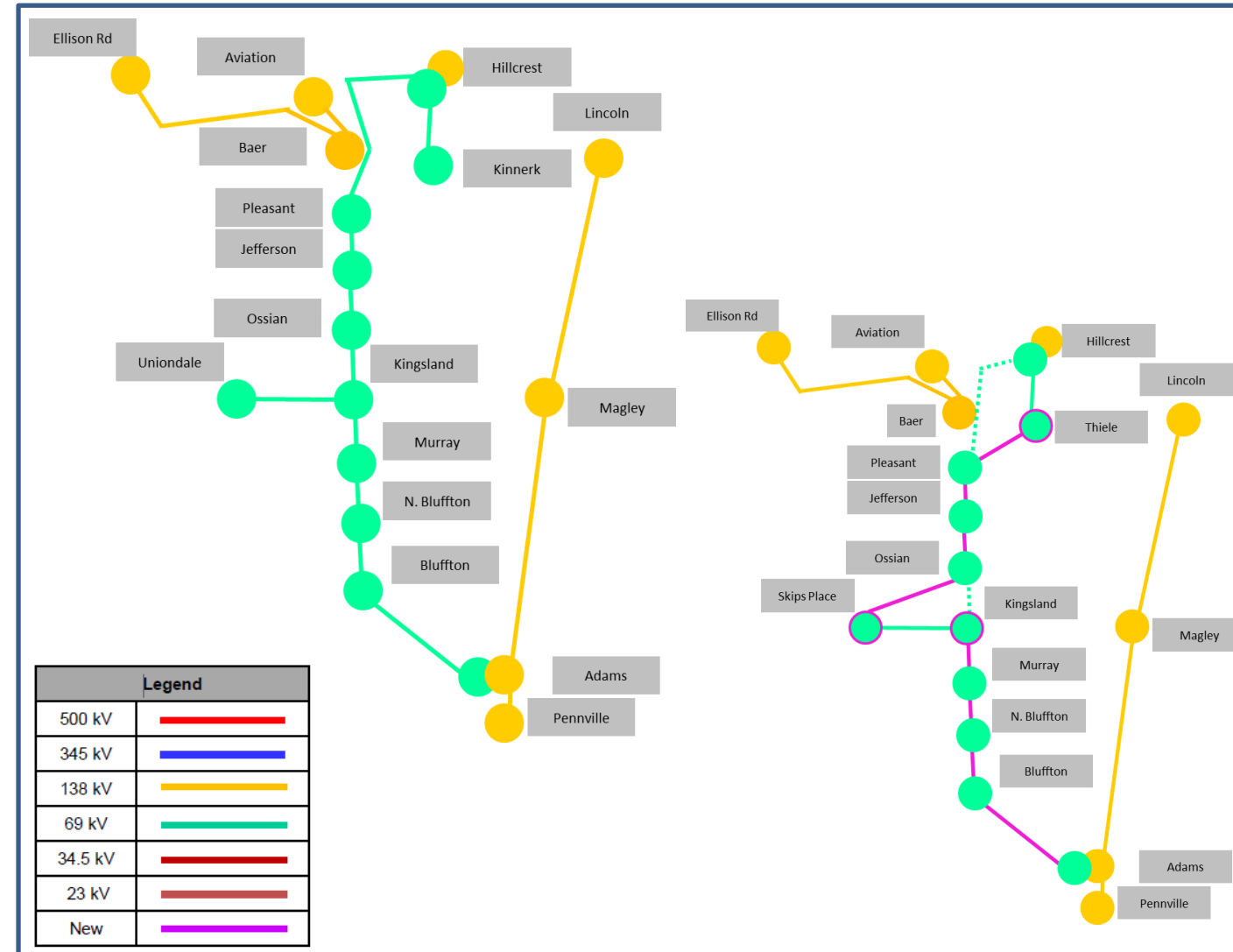

AEP Transmission Zone M-3 Process

Lick Station Rebuild

Need Number: AEP-2018-OH012

Process Stage: Submission of Supplemental Project for inclusion in the Local Plan
02/06/2020

Previously Presented:

Needs Meeting 10/28/2018

Solutions Meeting 12/18/2019

Project Driver:

Equipment Material/Condition/Performance/Risk

Specific Assumption Reference:

AEP Guidelines for Transmission Owner Identified Needs

Problem Statement:

At Lick substation there are six 69 kV circuit breakers with condition issues. CB's 61, 62, 65, 66, 67, and 69 are oil type breakers that were manufactured between 1956 - 1967. There is a potential for oil spills during routine maintenance and fault operations. In addition, spare parts are difficult to obtain. The breakers' fault operation counts are as follows: {61-126, 62-11, 65-26, 66-8, 67-19 and 69-4}. For most of these breakers, the number of fault operations exceed the manufacturers recommended number of 10.

There are three 138/69 kV, 18 MVA transformers at Lick. T#1 is a Westinghouse transformer manufactured in 1956. Transformers #2 and #3 are both GE transformers manufactured in 1950. All three transformers have maintenance issues with their LTCs and have significant oil leaks. In addition, loss of two of the transformers can load the remaining transformers tertiary winding above it's rating.



AEP Transmission Zone M-3 Process

Lick Station Rebuild

Need Number: AEP-2018-OH012

Process Stage: Submission of Supplemental Project for inclusion in the Local Plan 02/06/2020

Selected Solution:

- At Lick station, replace the three existing 138/69-12kV transformers with two 138/12 kV transformers and one 138/69 kV transformer. The 69 kV bus will be rebuilt in the clear within the station due to constructability concerns. Three 69kV 40kA, 3000A CBs will be installed on the low side of transformer and 69 kV line exits. An additional 138kV 40kA, 3000A CB will be added at the station to separate the 138 kV circuits towards the City of Jackson and Don Marquis. **(S2154.1) Estimated Cost: \$8.3M**
- Relocate the Don Marquis – Lick 138 kV circuit associated with the station work at Lick. **(S2154.2) Estimated Cost: \$0.7M**
- Relocate the Firebrick – Lick 69 kV circuit associated with station work at Lick. **(S2154.3) Estimated Cost: \$0.8M**
- Relocate the Ironman – Lick 69 kV circuit associated with station work at Lick. **(S2154.4) Estimated Cost: \$0.5M**

Estimated Cost: \$10.3 M

Projected In-Service: 02/15/2021

Supplemental Project ID: S2154.1-4

Project Status: Scoping

Model: N/A

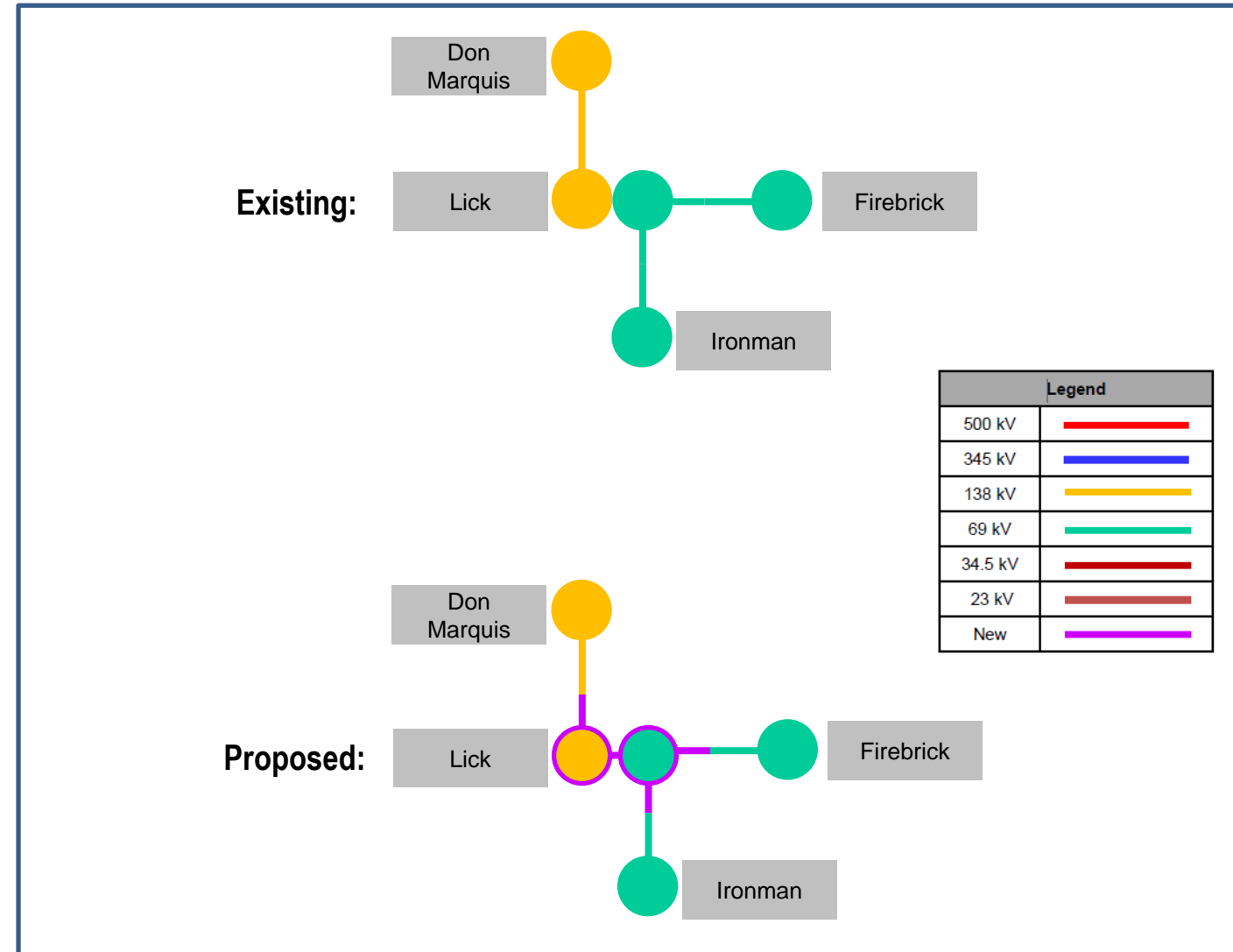

AEP Transmission Zone M-3 Process Findlay Area Improvements

Need Number: AEP-2019-OH007

Process Stage: Submission of Supplemental Project for inclusion in the Local Plan 02/06/2020

Previously Presented:

Needs Meeting 03/25/2019

Solutions Meeting 12/18/2019

Project Driver:

Equipment Material/Condition/Performance/Risk

Specific Assumption Reference:

AEP Guidelines for Transmission Owner Identified Needs

Problem Statement:

Findlay Center Station:

- 34.5 kV CB's A, B, C, and D are oil type breakers (vintage 1962). Many of these breakers have exceeded the manufacturers recommended number of fault operations (10): "A" (37), "B" (7), "C" (6), and "D" (39).
- 34.5 kV cap switcher AA is a MARK-V model (2004) which has been identified for replacement due to lack of spare parts, operational and reliability concerns, and maintenance issues.

Findlay Station:

- 34.5 kV CB's A, B, D, and E are oil type breakers (vintage 1953– 1955). Many of these breakers have exceeded the manufacturers recommended number of fault operations (10): "A" (20), "B" (33), "D" (41), and "E" (3).
- 34.5 kV cap switcher AA is a VBM model (1988) which has been identified for replacement due to lack of spare parts, operational and reliability concerns, and maintenance issues.

Plaza Street Station:

- 34.5 kV CB A is an oil type breaker (vintage 1948). This breaker has exceeded the manufacturers recommended number of fault operations (10): "A" (13).

East Findlay Station:

- The three-way switch (1958) has ongoing difficulties maintaining proper alignment of switches. The insulators are cap-and-pin type which often physically failing during switching operations.

**Oil breaker maintenance is difficult due to the oil handling requirements and there is a risk for oil spills during failures and maintenance. These breakers are FK model breakers that have historical reliability concerns and lack of spare part availability.

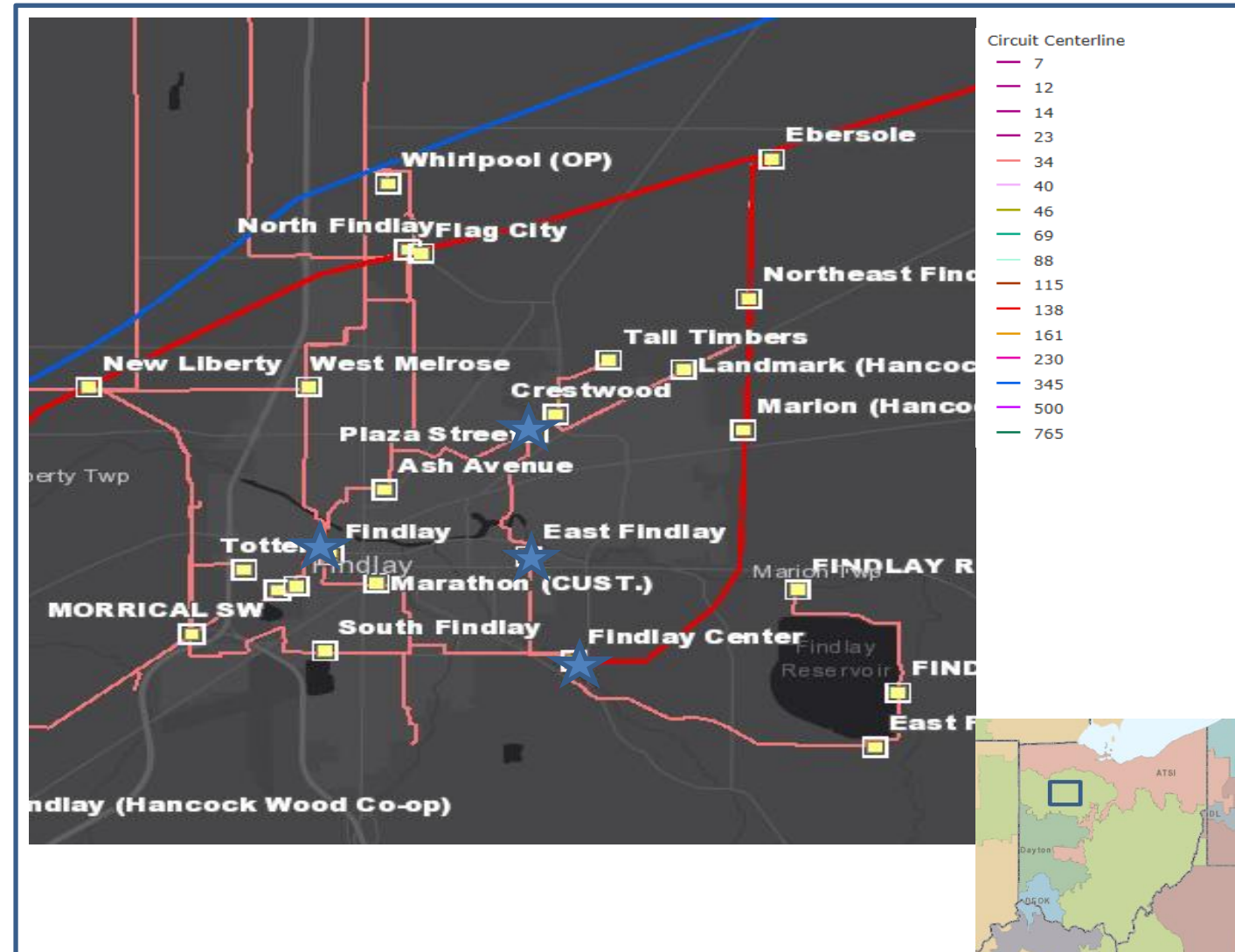

AEP Transmission Zone M-3 Process Findlay Area Improvements

Need Number: AEP-2019-OH054

Process Stage: Submission of Supplemental Project for inclusion in the Local Plan 02/06/2020

Previously Presented:

Needs Meeting 9/25/2019

Solutions Meeting 12/18/2019

Project Driver:

Equipment Material/Condition/Performance/Risk

Specific Assumption Reference:

AEP Guidelines for Transmission Owner Identified Needs

Problem Statement:

Line:

Findlay – Findlay Center Circuit (1934)

- Length: 3.43 miles
- Original Construction Type: Wood (87% - Pre 1964, 10% - 1965-1974, 3% - 2012)
- Original Conductor Type: 4/0 Copper 7
- Total structure count: 98
- Number of open conditions: 49
 - Open conditions include: damaged conductor, pole rot, insect damage, contaminated insulators
- Unique structure count with open conditions: 37
- Additional Info: N/A

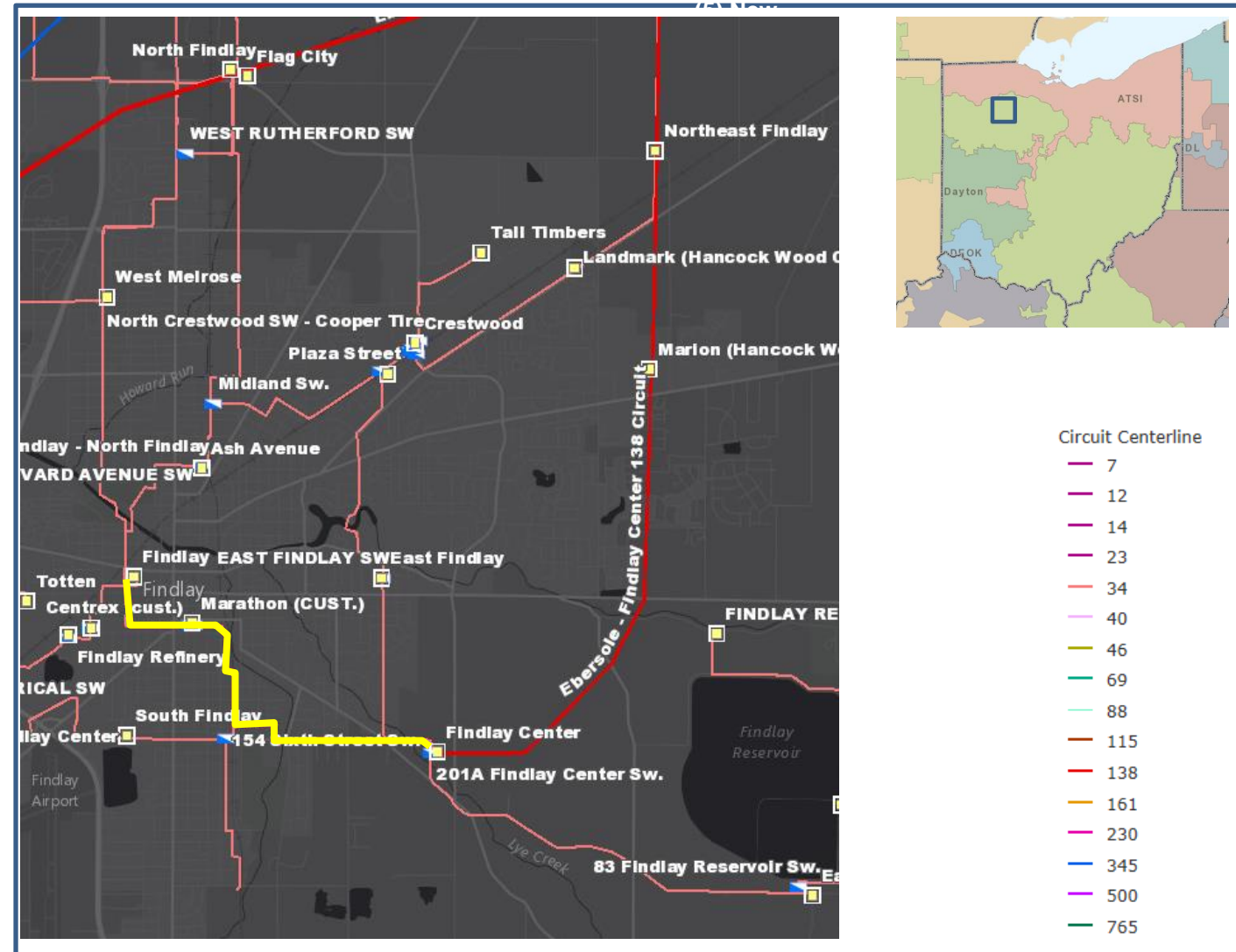

AEP Transmission Zone M-3 Process Findlay Area Improvements

Need Number: AEP-2019-OH007 & AEP-2019-OH054

Process Stage: Submission of Supplemental Project for inclusion in the Local Plan 02/06/2020

Selected Solution:

- At Plaza Street station, replace 34.5kV CB-A with 69kV (2000A / 40kA) and remove CB-A bypass switch. **(S2155.1) Estimated Cost: \$1.3M**
- At Findlay station, replace CB's A, B, D, E with 69kV breakers (2000A / 40kA) and replace Circuit Switcher AA with 69kV (2000A / 25kA). **(S2155.2) Estimated Cost: \$4.0M**
- At Findlay Center station, replace CB's A, B, C, D with 69kV breakers (2000A / 40kA), add an additional 69kV breaker (2000A / 40kA) and change bus to ring configuration, and replace Circuit Switcher AA with 69kV (1200A / 25kA). **(S2155.3) Estimated Cost: \$5.0M**
- At Findlay Center Sw, replace two-way switch with three-way 69kV POP switch. **(S2155.4) Estimated Cost: \$0.3M**
- At East Findlay, replace existing switch with three-way 69kV POP switch. **(S2155.5) Estimated Cost: \$0.6M**
- At South Findlay station, perform remote end relay work. **(S2155.6) Estimated Cost: \$0.5M**
- Rebuild 1.8 mile Findlay – Fifth Street 34.5 kV line asset, partially underground for 0.8 miles due to urban construction environment with the remaining mile overhead. **(S2155.7) Estimated Cost: \$15.1M**
- Rebuild 1.6 miles of double circuit section of the New Liberty – Findlay Center 34.5 kV line asset. **(S2155.8) Estimated Cost: \$8.6M**
- Replace 4 structures on double circuit section of New Liberty – Findlay 34.5 kV line asset. **(S2155.9) Estimated Cost: \$1.3M**

Estimated Cost: \$36.7 M

Projected In-Service: 06/01/2021

Supplemental Project ID: S2155.1-9

Project Status: Scoping

Model: N/A

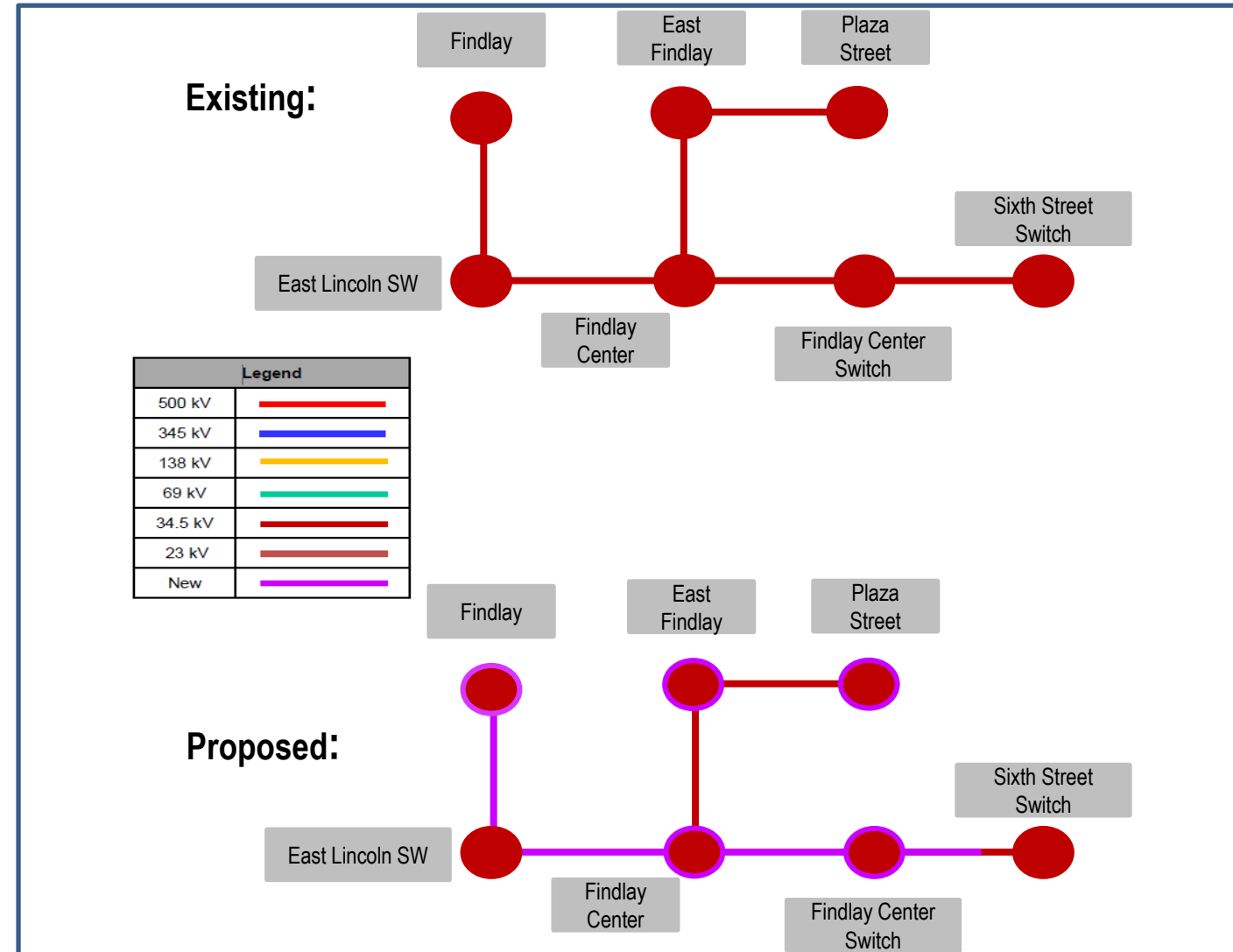

AEP Transmission Zone M-3 Process

Howard – Bucyrus Rebuild

Need Number: AEP-2019-OH016

Process Stage: Submission of Supplemental Project for inclusion in the Local Plan
02/06/2020

Previously Presented:

Needs Meeting 4/23/2019

Solutions Meeting 12/18/2019

Project Driver:

Equipment Material/Condition/Performance/Risk

Specific Assumption Reference:

AEP Guidelines for Transmission Owner Identified Needs

Problem Statement:

- The Bucyrus-Howard No.2 69kV circuit was originally constructed in 1919 with wood structures and copper conductor (#1 CU and 3/0 CU). 84% of the line still utilizes the original 1919 copper conductor.
- Some structures have been replaced over the years; however, they have been like for like wood pole replacements.
- The circuit has had 38 forced operations in the last 11 years of which 7 have been permanent and resulted in 54 hours of down time. 2 out of the 7 outages have been caused by conductor failures, the most recent of which resulted in 188,000 CMI.
- There are currently 144 open conditions along the 23 mile long line.
- Age profile (16% - Pre 1940's, 10% - 1950's, 14% - 1960's, 28% - 1970's, 12% - 1980's, 12% - 1990's; 8% - 2000's)
- 2% Steel; 98% Wood.

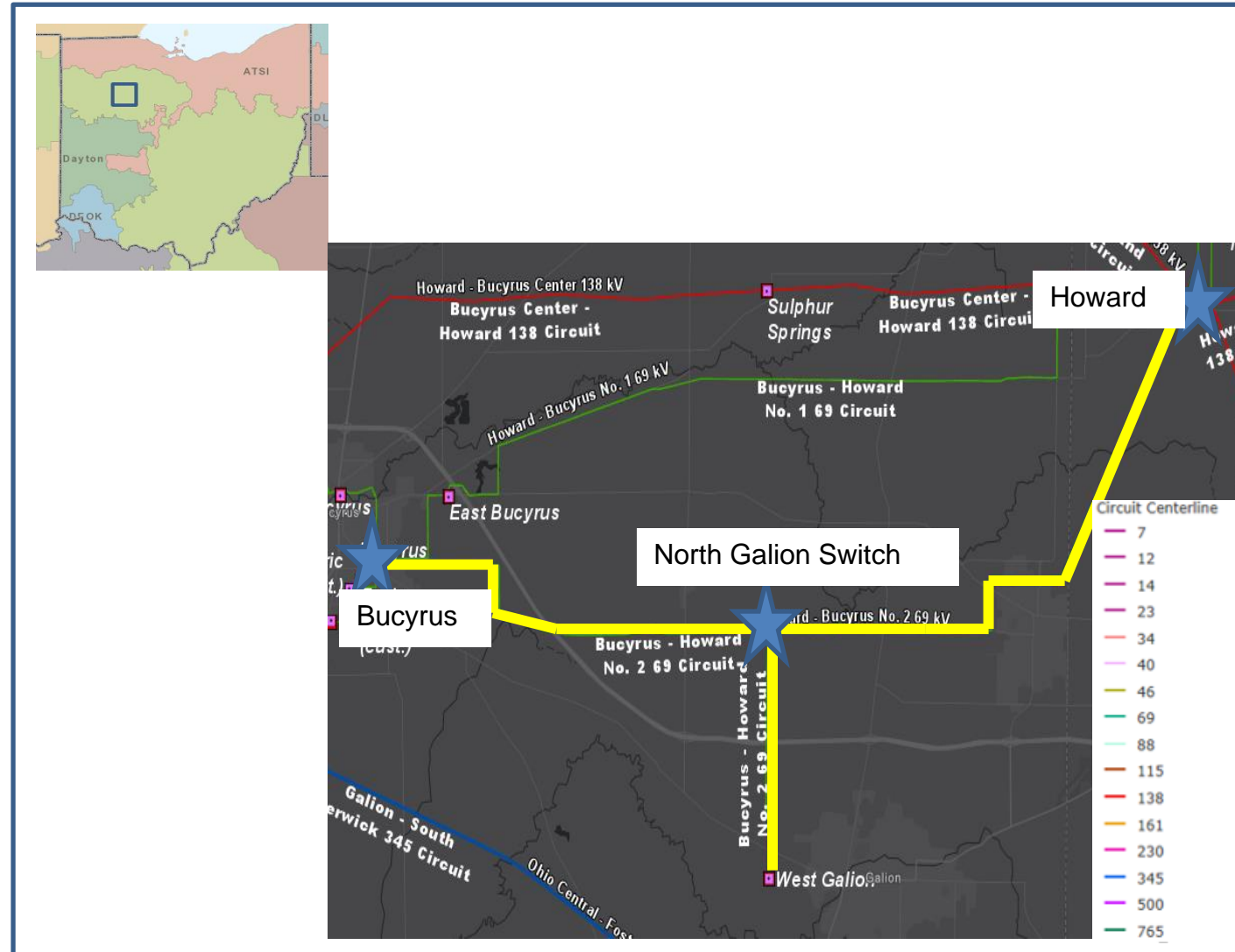

AEP Transmission Zone M-3 Process Howard – Bucyrus Rebuild

Need Number: AEP-2019-OH016

Process Stage: Submission of Supplemental Project for inclusion in the Local Plan 02/06/2020

Selected Solution:

Rebuild the Bucyrus-Howard #2 circuit (approx. 25 miles) utilizing 556 ACSR conductor. As part of the rebuild the existing North Galion switch will be retired and the line will be rerouted to provide looped service to West Galion station. (**\$2156.1**)

Estimated Cost: \$51.9M

Work at West Galion will be required to terminate the additional 69 kV feed at the station. (**\$2156.2**)

Estimated Cost: \$0.8M

Estimated Cost: \$52.7 M

Projected In-Service: 3/31/2022

Supplemental Project ID: S2156.1-2

Project Status: Scoping

Model: N/A

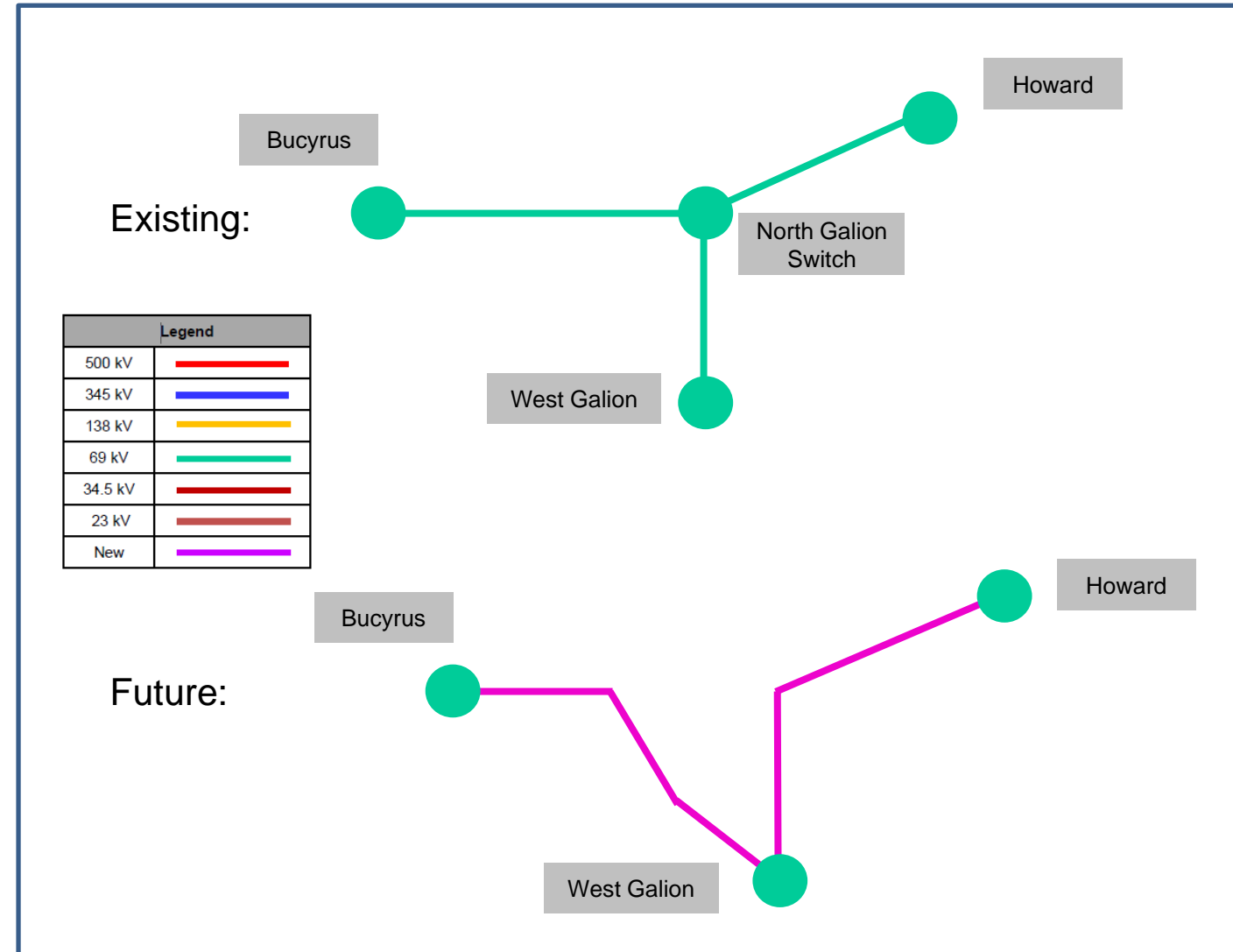

AEP Transmission Zone M-3 Process Hayden

Need Number: AEP-2019-OH017

Process Stage: Submission of Supplemental Project for inclusion in the Local Plan 02/06/2020

Previously Presented:

Needs Meeting 04/23/2019

Solutions Meeting 12/18/2019

Project Driver:

Customer Service

Specific Assumption Reference:

AEP Guidelines for Transmission Owner Identified Needs

Problem Statement:

- AEP-Ohio is requesting a new 138kV delivery point at Hayden Station by 6/1/2020.
- There are several highly loaded distribution circuits at Dublin, Davidson, & Hilliard Stations that require a new delivery point.

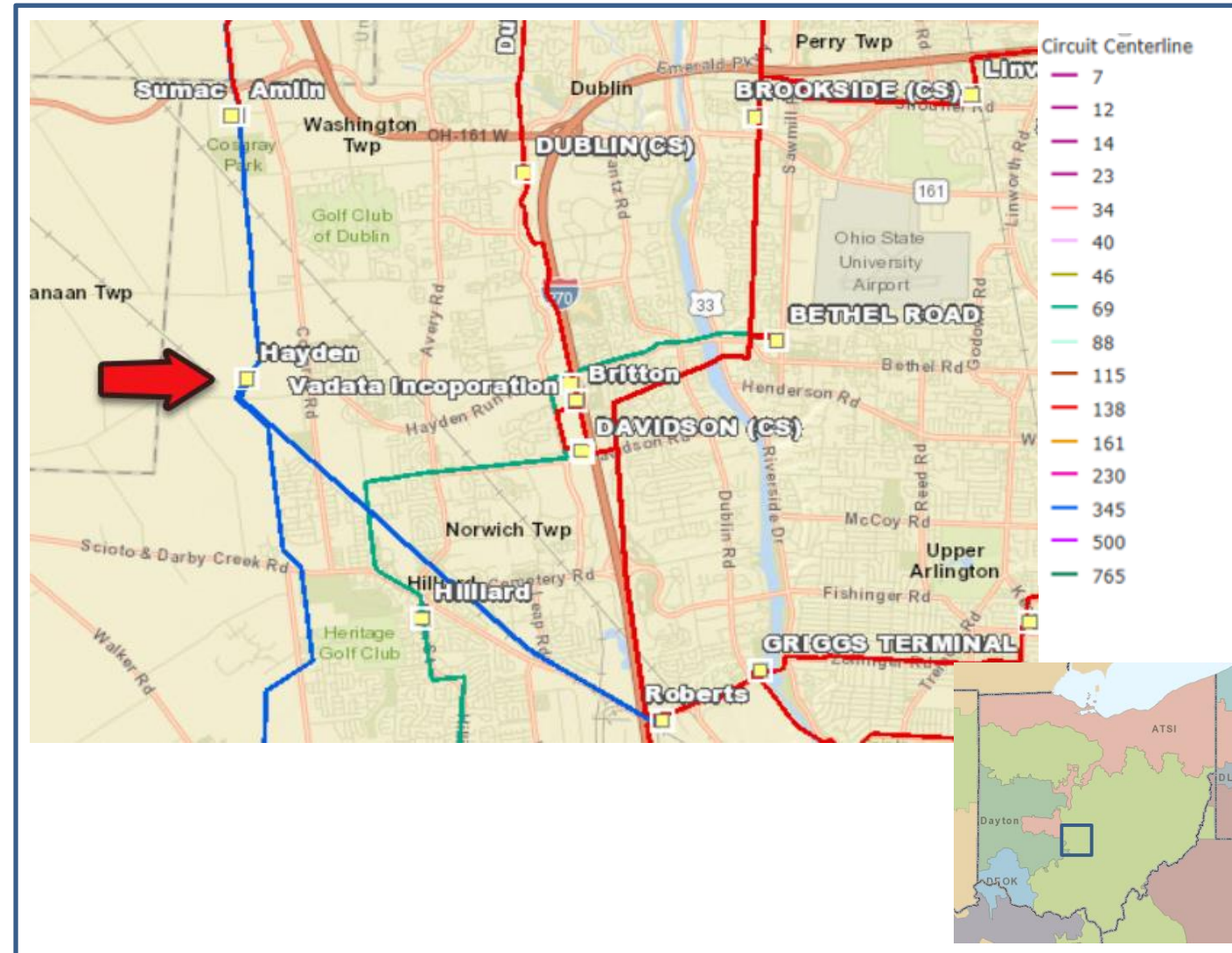

Need Number: AEP-2019-OH017

Process Stage: Submission of Supplemental Project for inclusion in the Local Plan 02/06/2020

Selected Solution:

Cut the existing Amlin – Cole 138kV circuit into new Hayden 138kV yard using 2-954 ACSR. (**S2157.1**) **Estimated Cost: \$1.2M**

Install a new 138kV yard at Hayden station, including 3 circuit breakers (3000A, 138kV, 63KA CB's) and bus work to be operated in a ring bus configuration to serve a 50 MVA transformer for AEP Ohio. Install a new DICM (16'X27') with associated components. Expand the station grading, fencing, and ground grid to accommodate this new 138 kV yard. (**S2157.2**) **Estimated Cost: \$9.2M**

Total Estimated Transmission Cost: \$10.4 M

Projected In-Service: 06/01/2020

Supplemental Project ID: S2157.1-.2

Project Status: Scoping

Model: 2024 RTEP

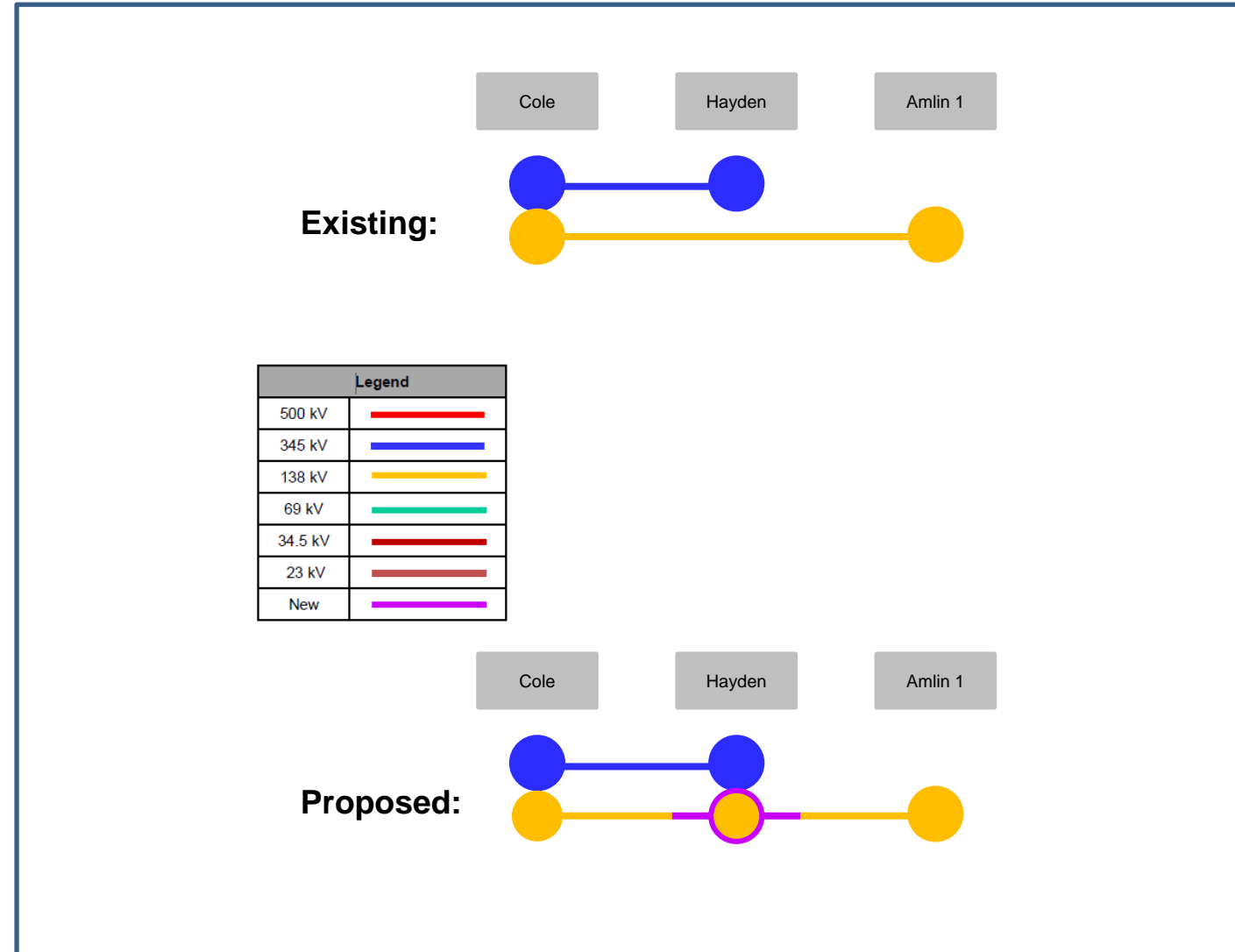

AEP Transmission Zone M-3 Process East Beaver

Need Number: AEP-2019-OH023

Process Stage: Submission of Supplemental Project for inclusion in the Local Plan 02/06/2020

Previously Presented:

Needs Meeting 5/20/2019

Solutions Meeting 12/18/2019

Project Driver:

Equipment Material/Condition/Performance/Risk and Operational Flexibility and Efficiency

Specific Assumption Reference:

AEP Guidelines for Transmission Owner Identified Needs (AEP Assumptions Slide 8)

Problem Statement:

Equipment Material/Condition/Performance/Risk:

The East Beaver – Buckeye Co-Op 69 kV line was built in 1952. 60 out of the 71 wood structures of this 4.5 mile line are of early 1950s vintage and are affected by heavy rot and woodpecker & insect damage. There are 26 open A conditions on this line. The conductor on the entire line has never been replaced since originally installed.

Operational Flexibility and Efficiency

Currently, the East Beaver 138/69 kV Station has more than 2 dissimilar zones of protection (bus, line, and transformer).

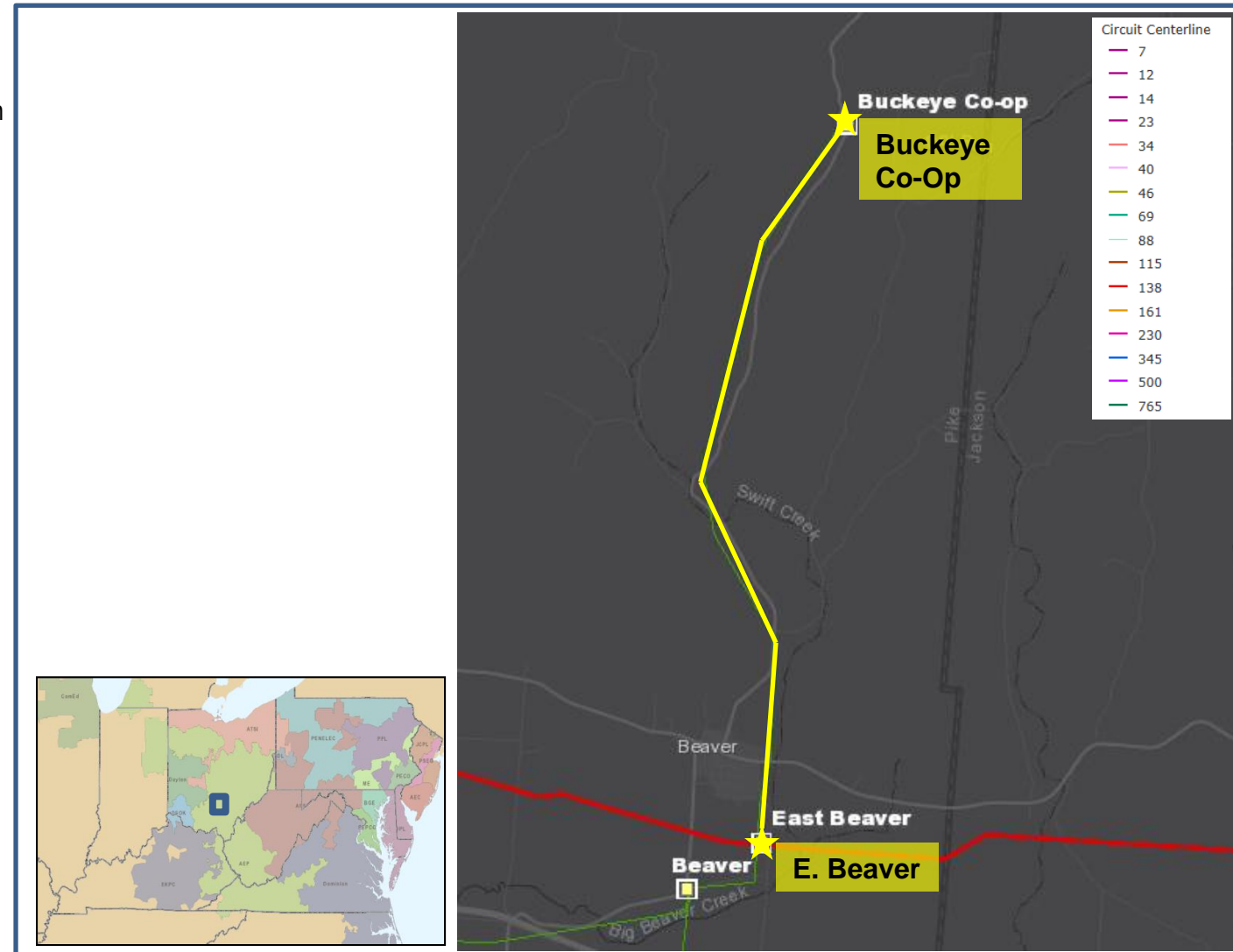

AEP Transmission Zone M-3 Process East Beaver

Need Number: AEP-2019-OH023

Process Stage: Submission of Supplemental Project for inclusion in the Local Plan 02/06/2020

Selected Solution:

Rebuild the ~4.5 miles Beaver-Buckeye Co-op 69 kV radial line. **(S2158.1) Estimated Cost: \$13.5M**

At East Beaver station, install three 138 kV breaker ring bus using 3000A, 40 kA breakers in a ring configuration. Install new DICM Control House. Install 3 new 3000A, 40 kA 69 kV breakers in a ring configuration. **(S2158.2) Estimated Cost: \$5.8M**

Total Estimated Cost: \$19.3 M

Projected In-Service: 11/15/2021

Supplemental Project ID: S2158.1-.2

Project Status: Scoping

Model: N/A

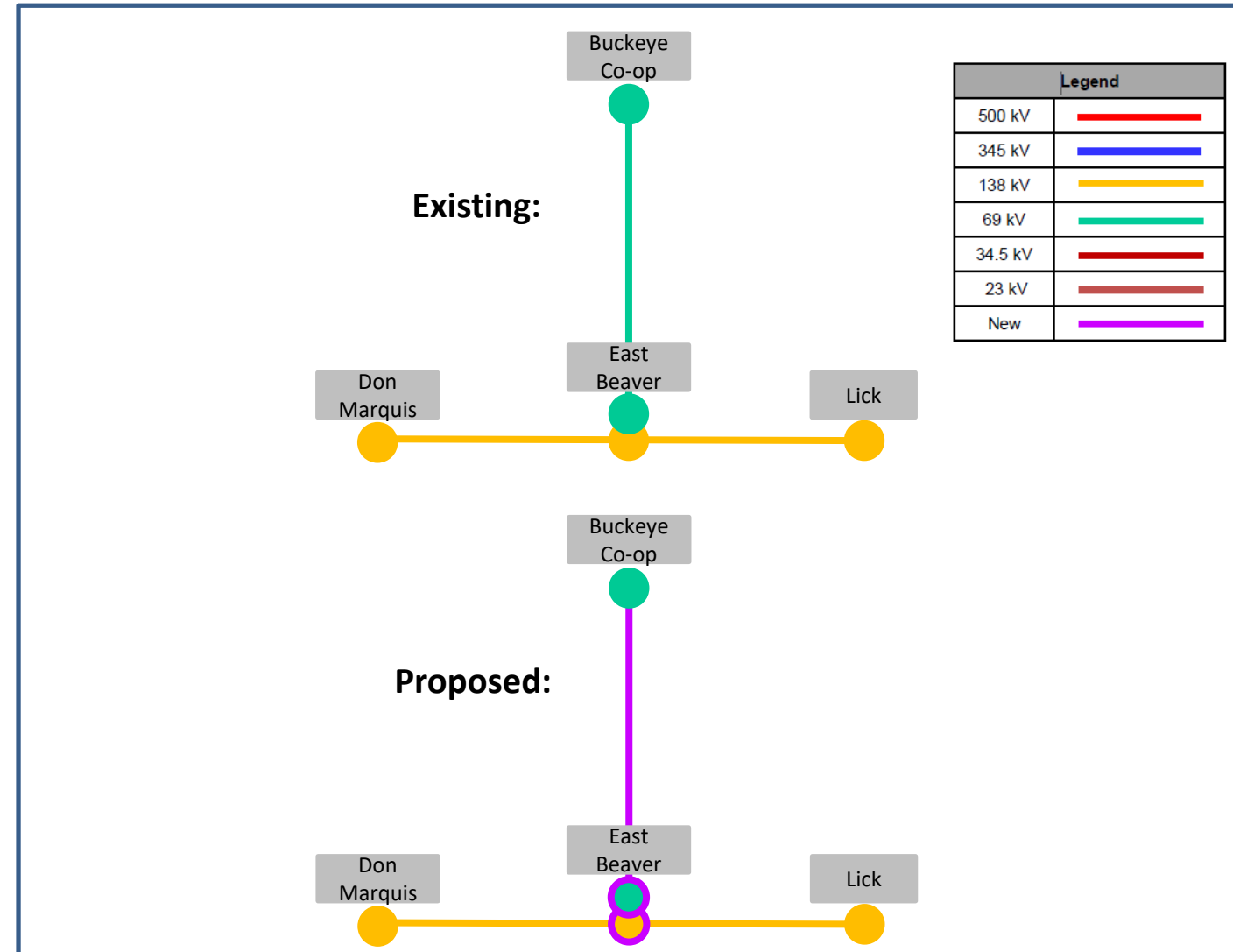

AEP Transmission Zone M-3 Process South Point - Sporn

Need Number: AEP-2019-OH026

Process Stage: Submission of Supplemental Project for inclusion in the Local Plan 02/06/2020

Previously Presented:

Needs Meeting 05/20/2019

Solutions Meeting 12/18/2019

Project Driver:

Operational Flexibility

Specific Assumption Reference:

AEP Guidelines for Transmission Owner Identified Needs

Problem Statement:

- The 58-mile South Point – Sporn 138 kV double circuit line has four delivery points that are connected via hard taps. The hard taps complicate restoration activities and extend outages.
- The four Buckeye Coop delivery points are at Mercerville, Windsor, -Fayette, and Addison. These stations are in a remote part of AEP's service territory, which makes outage restoration activities more difficult and resulting in longer outages.
- Over the last five years these delivery points have accumulated 1,348,755 CMI.

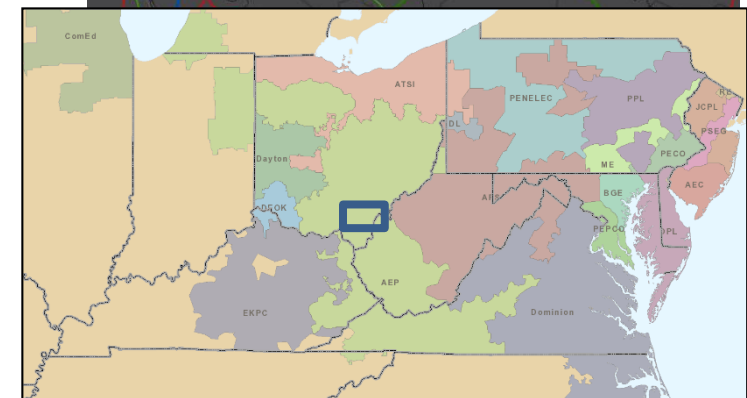
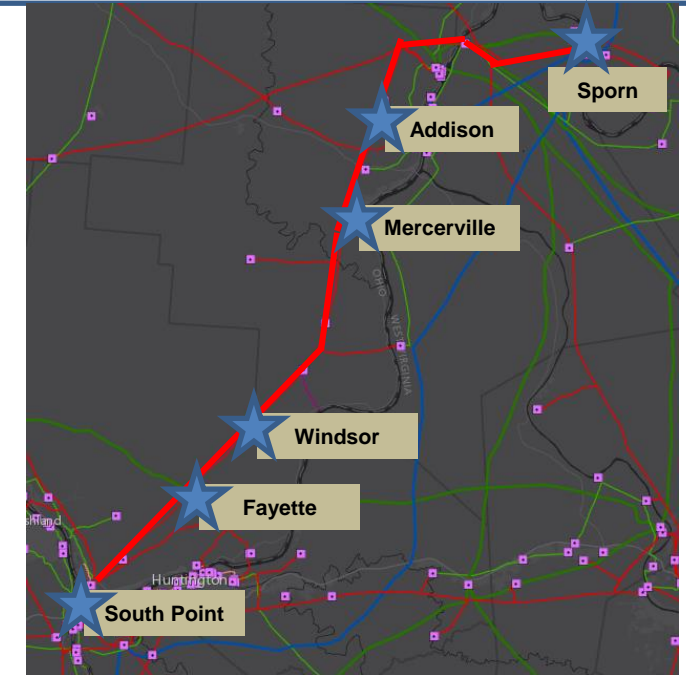

AEP Transmission Zone M-3 Process South Point - Sporn

Need Number: AEP-2019-OH026

Process Stage: Submission of Supplemental Project for inclusion in the Local Plan 02/06/2020

Selected Solution:

Install 3-way 138 kV (2000 A) MOAB's at Mercerville hard tap, including dead end structures to connect to new switch pole location. **(S2159.1) Estimated Cost: \$2.2M**

Install 3-way 138 kV (2000 A) MOAB's at Windsor hard tap. **(S2159.2) Estimated Cost: \$1.3M**

Install 3-way 138 kV (2000 A) MOAB's at Fayette hard tap. Extend the existing line 0.25 miles to the new switch location. **(S2159.3) Estimated Cost: \$3.5M**

Install 3-way 138 kV (2000 A) MOAB's at Addison hard tap, including dead end structures to connect to new switch pole location. **(S2159.4) Estimated Cost: \$2.5M**

Total Estimated Cost: \$9.5 M

Projected In-Service: 4/30/2021

Supplemental Project ID: S2159.1-4

Project Status: Scoping

Model: N/A

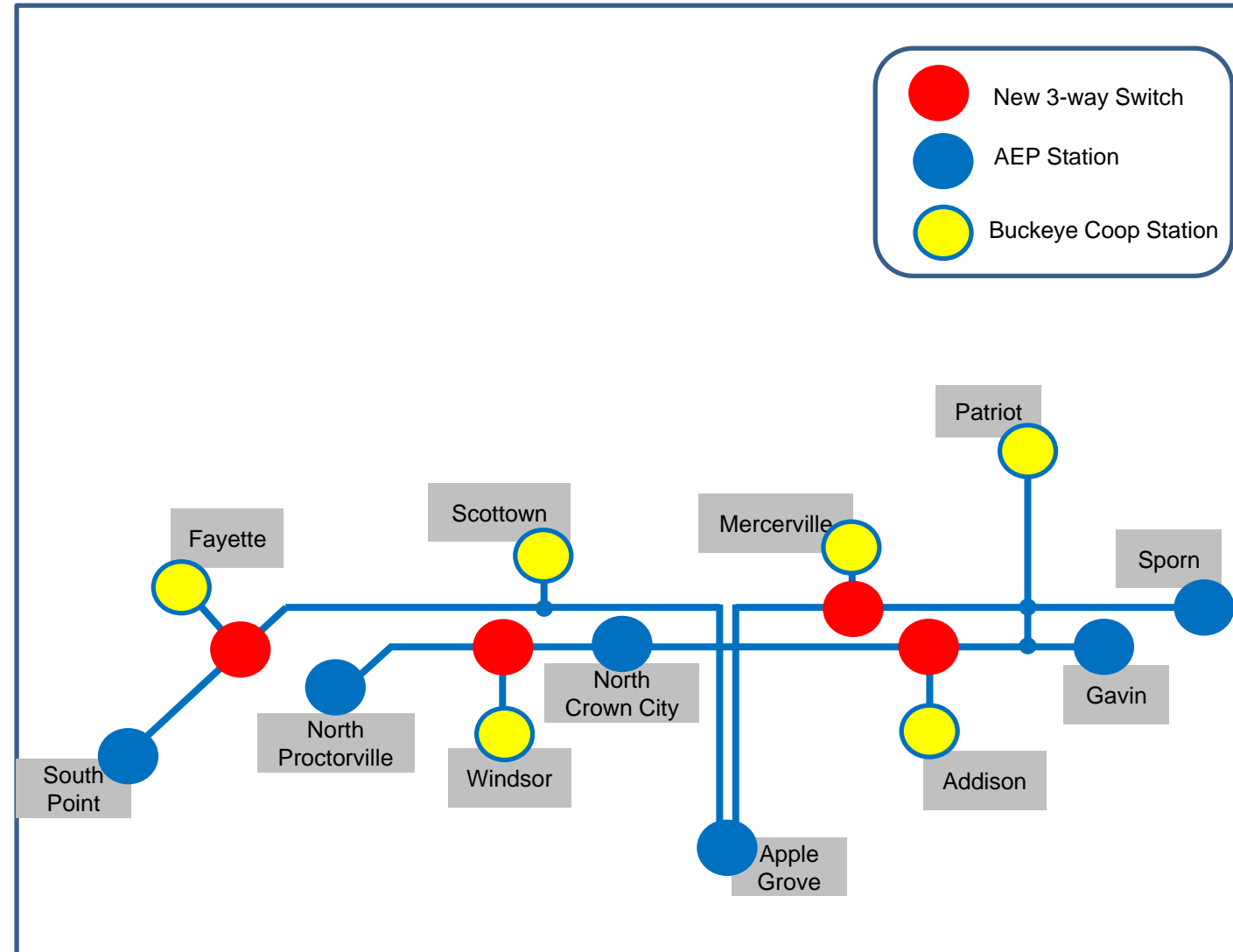

AEP Transmission Zone M-3 Process Crooksville – North Newark Rebuild

Need Number: AEP-2019-OH030

Process Stage: Submission of Supplemental Project for inclusion in the Local Plan 02/06/2020

Previously Presented:

Needs Meeting 6/17/2019

Solutions Meeting 12/18/2019

Project Driver:

Equipment Material/Condition/Performance/Risk

Specific Assumption Reference:

AEP Guidelines for Transmission Owner Identified Needs

Problem Statement:

Line:

Crooksville – North Newark (Vintage - 1952)

- Length: 30.63 Miles
- Original Construction Type: Wood
- Original Conductor Type: 266,800 CM ACSR 26/7 (Partridge)
- Momentary/Permanent Outages: 5 outages last 5 years
- Number of open conditions: 338
 - Open conditions include: Pole Rot, Insect/Bird Damage, Damaged Conductors, Ground Wires, & Guy Wires.

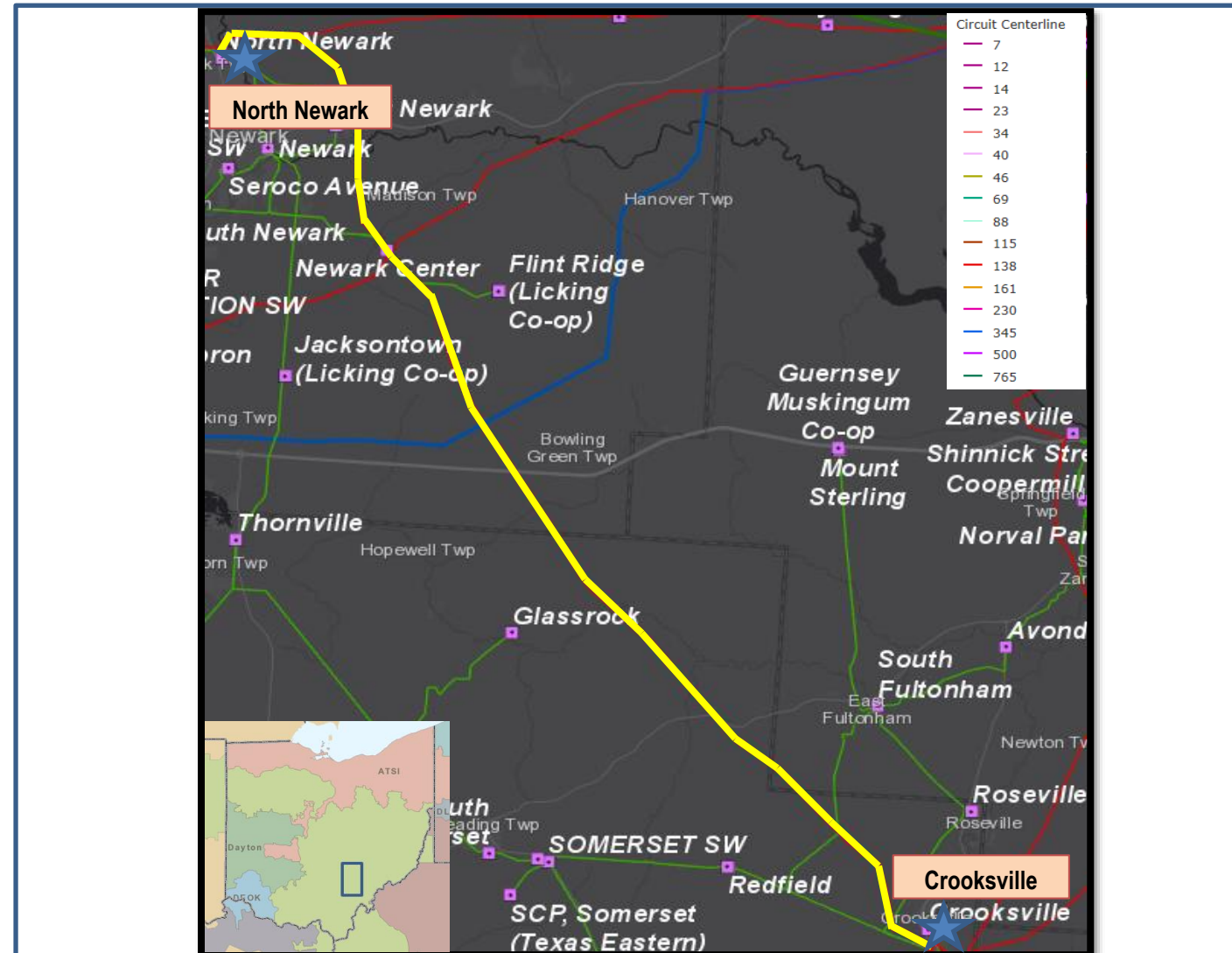

AEP Transmission Zone M-3 Process Crooksville – North Newark Rebuild

Need Number: AEP-2019-OH030

Process Stage: Submission of Supplemental Project for inclusion in the Local Plan 02/06/2020

Selected Solution:

Rebuild the existing 31.6-mile Crooksville - North Newark line using 795 ACSR. (**S2160**)

Estimated Cost: \$55.6 M

Projected In-Service: 12/1/2023

Supplemental Project ID: S2160

Project Status: Engineering

Model: N/A

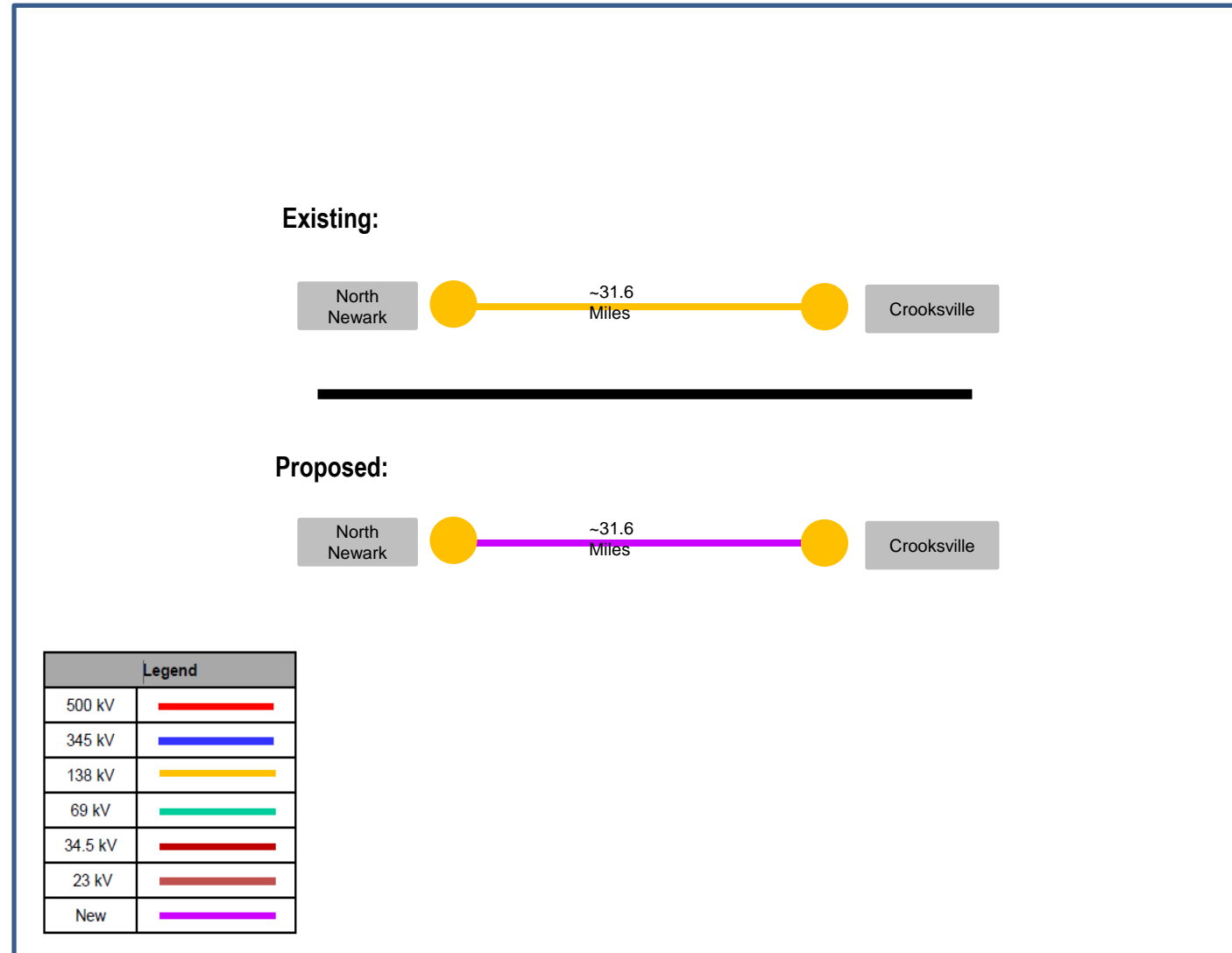

AEP Transmission Zone M-3 Process Huntley Failed Bank Replacement

Need Number: AEP-2019-OH056

Process Stage: Submission of Supplemental Project for inclusion in the Local Plan 02/06/2020

Previously Presented:

Needs Meeting 10/25/2019

Solutions Meeting 12/18/2019

Project Driver:

Equipment Condition/Performance/Risk

Specific Assumption Reference:

AEP Guidelines for Transmission Owner Identified Needs (AEP Assumptions Slide 8)

Problem Statement:

Huntley Station

69/12kV Transformer #6

- The 1976 vintage 69/12kV transformer (33 MVA) has failed beyond repair in the field.



AEP Transmission Zone M-3 Process Huntley Failed Bank Replacement

Need Number: AEP-2019-OH056

Process Stage: Submission of Supplemental Project for inclusion in the Local Plan 02/06/2020

Selected Solution:

Huntley Station:

Replace the failed 69/12 kV transformer #6 with a new 138/12 kV transformer (**S2161**)

Estimated Cost: \$0.4 M

Projected In-Service: 11/10/2020

Supplemental Project ID: S2161

Project Status: Engineering

Model: N/A

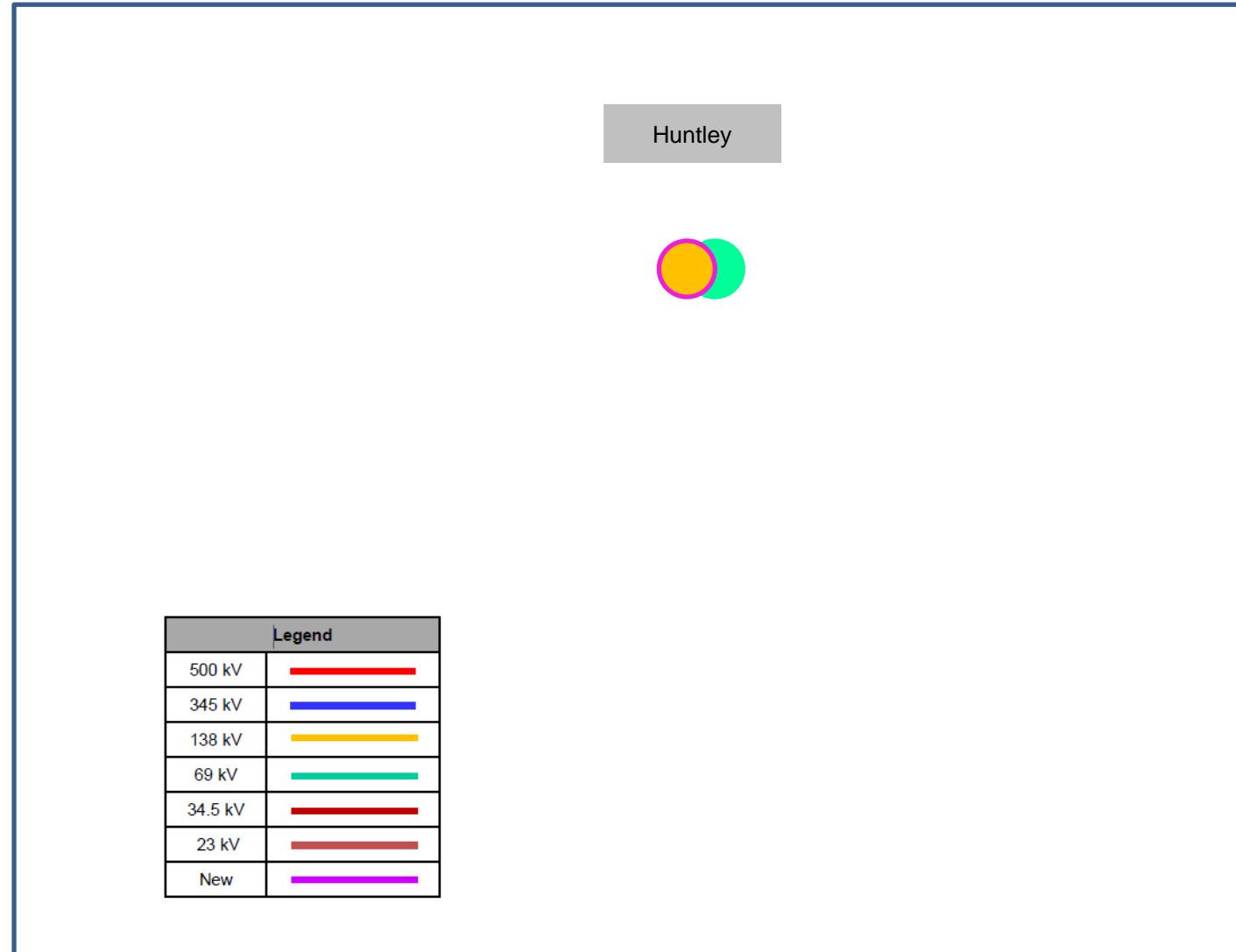

AEP Transmission Zone M-3 Process Shawtown Switch

Need Number: AEP-2019-OH057

Process Stage: Submission of Supplemental Project for inclusion in the Local Plan 02/06/2020

Previously Presented:

Needs Meeting 10/21/2019

Solutions Meeting 12/18/2019

Project Driver:

Customer Service

Specific Assumption Reference:

AEP Guidelines for Transmission Owner Identified Needs

Problem Statement:

Buckeye Power, Inc. on behalf of Hancock Wood Electric, Inc. has requested a new delivery point adjacent to their existing site. AEP plans to relocate the existing switch to be able to serve the new delivery point.

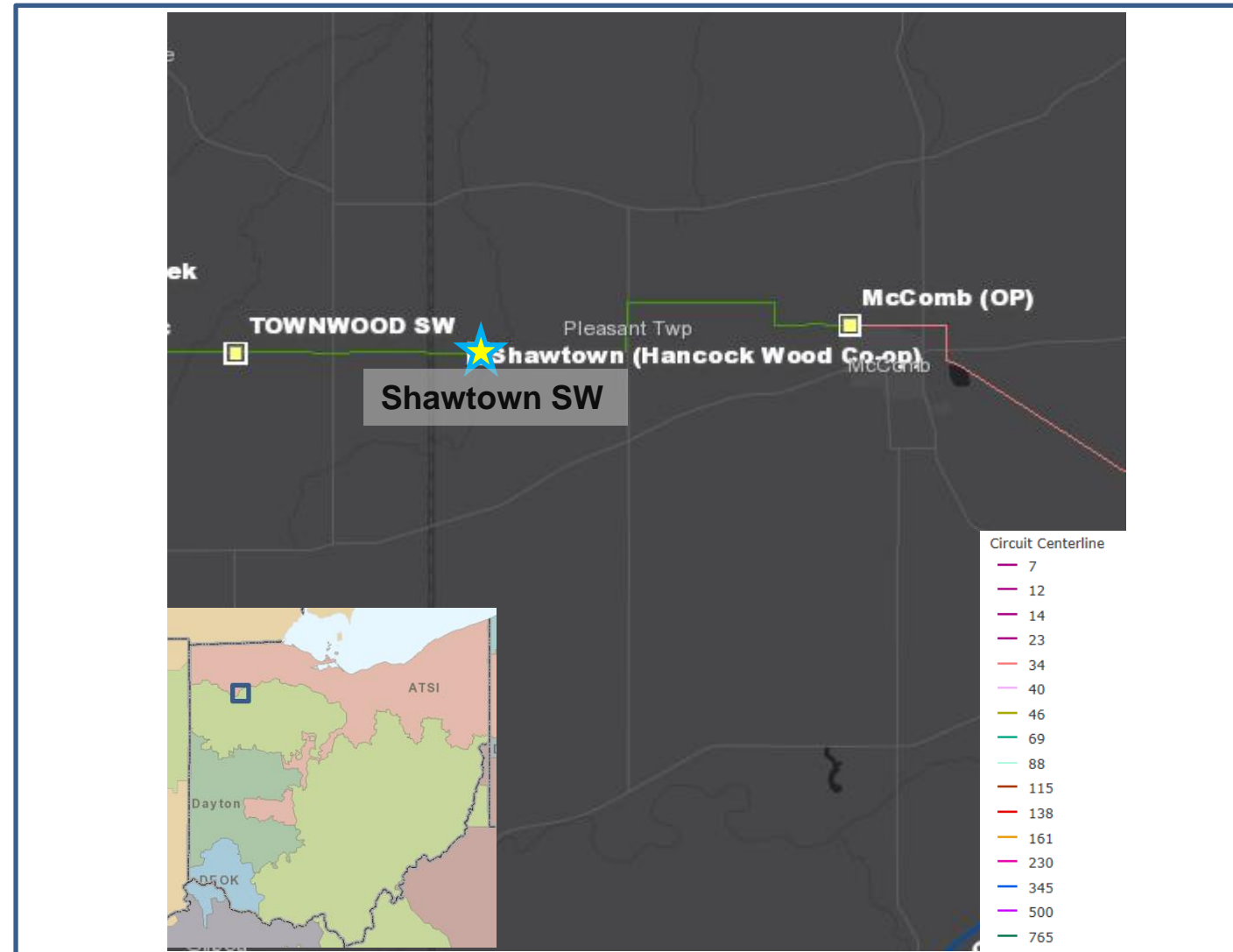

AEP Transmission Zone M-3 Process Shawtown Switch

Need Number: AEP-2019-OH057

Process Stage: Submission of Supplemental Project for inclusion in the Local Plan 02/06/2020

Selected Solution:

Upgrade the customer radial to 138kV standards (operated at 34.5kV) in anticipation of customer and full line conversion to 138kV. **(S2162.1)**

Estimated Cost: \$0.4M

Replace the existing Shawtown Switch with a 138kV standard switch (operated at 34.5kV) with SCADA controls. Additional structures are required on either side of the switch. **(S2162.2) Cost: \$1.3M**

Total Estimated Cost: \$1.7 M

Projected In-Service: 5/31/2020

Supplemental Project ID: S2162.1-.2

Project Status: Engineering

Model: 2024 RTEP

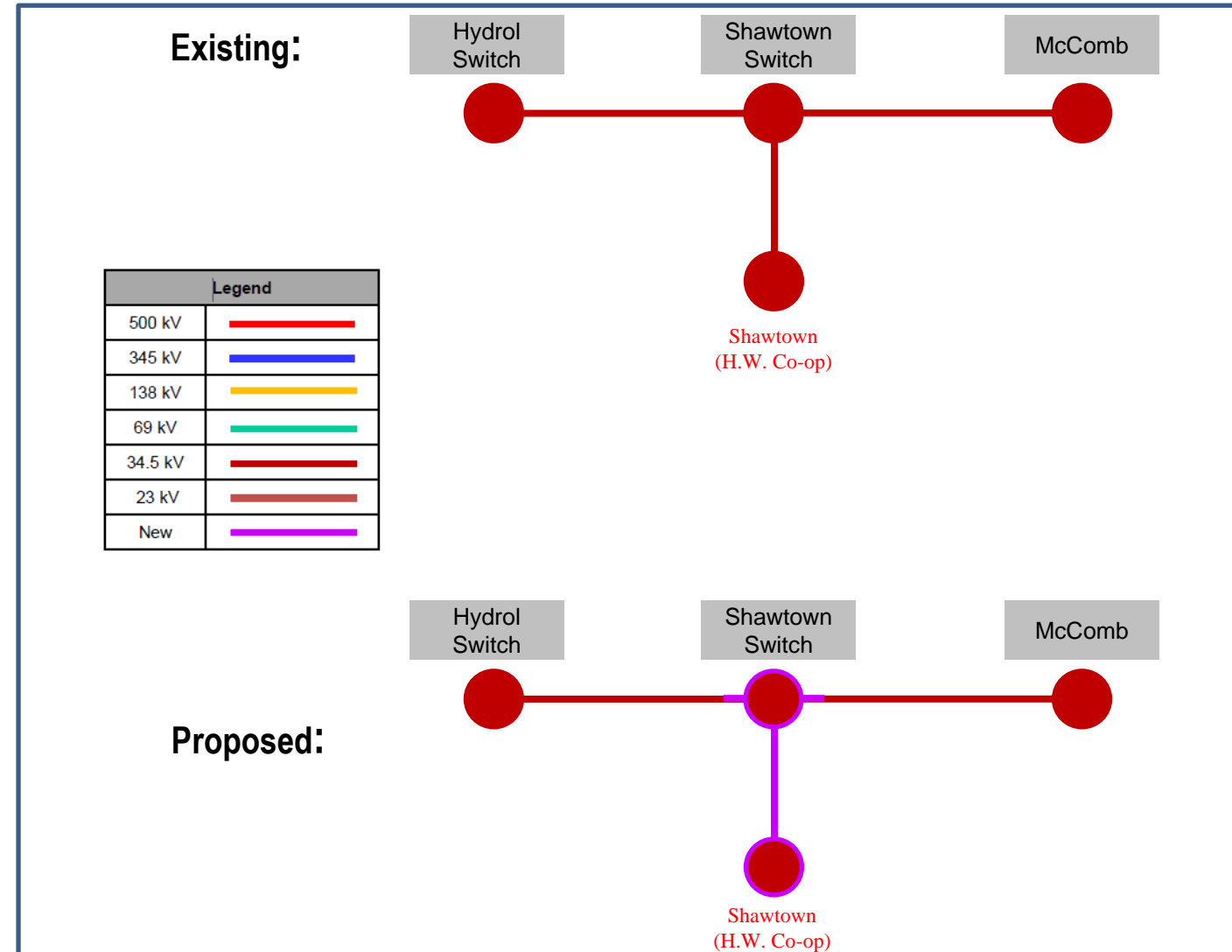

AEP Transmission Zone M-3 Process Dover 69kV Service

Need Number: AEP-2019-OH061

Process Stage: Submission of Supplemental Project for inclusion in the Local Plan 02/06/2020

Previously Presented:

Needs Meeting 11/22/2019

Solutions Meeting 12/18/2019

Project Driver:

Customer Service

Specific Assumption Reference:

AEP Connection Requirements for the AEP Transmission System (AEP Assumptions Slide 7)

Problem Statement:

- The City of Dover (municipal customer) has a normally-open 69kV backup delivery point from AEP at South Intertie Switch. Dover is normally served by AEP from the North Intertie 138kV station. Dover has requested that AEP close the normally-open 69kV switch, to provide two parallel points of service. Dover's peak summer load is 45 MW.

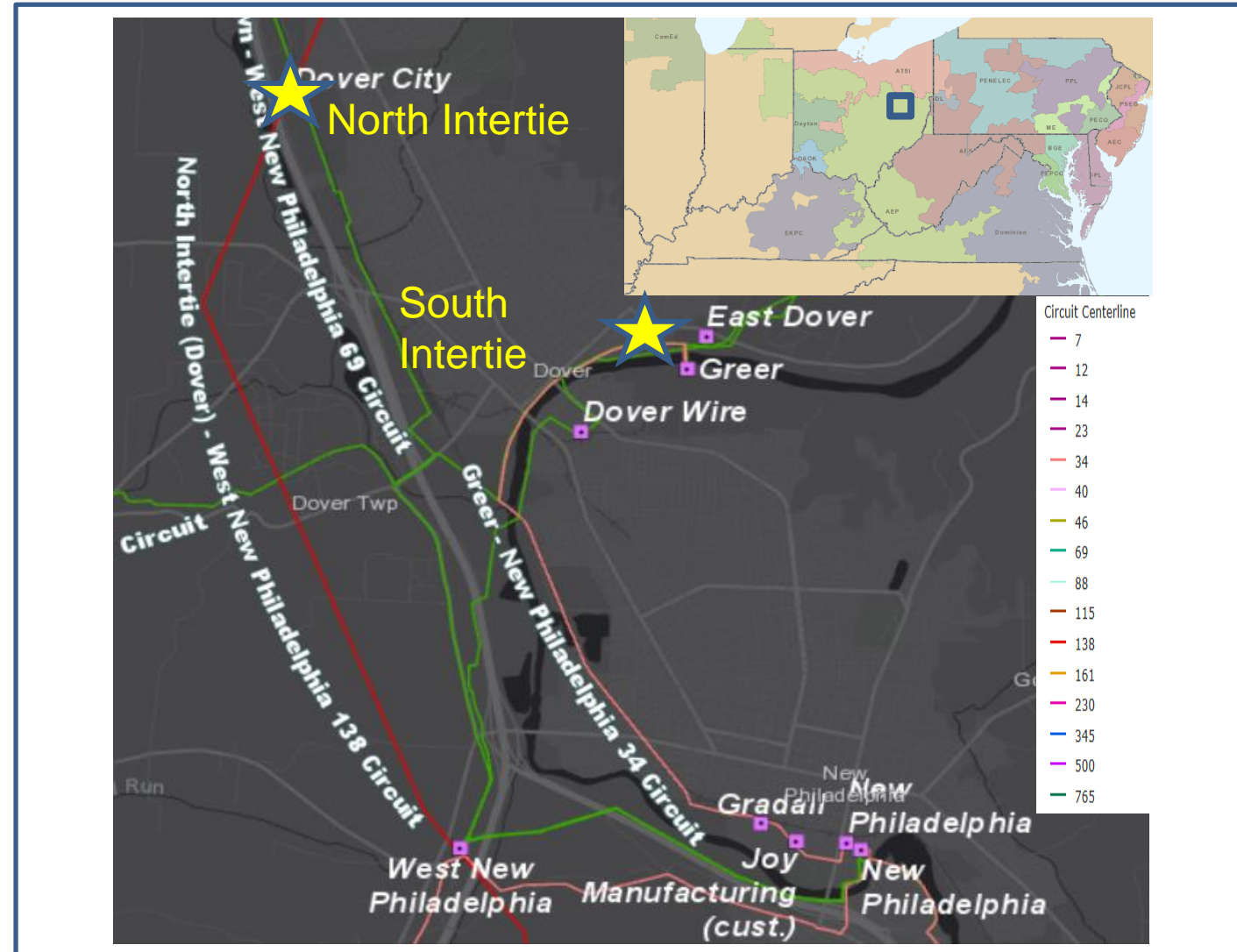

AEP Transmission Zone M-3 Process Dover 69kV Service

Need Number: AEP-2019-OH061

Process Stage: Submission of Supplemental Project for inclusion in the Local Plan 02/06/2020

Selected Solution:

Close the normally-open South Intertie 69kV Switch 'U' toward the City of Dover, to provide two points of service. Adjust area protective relaying settings, to account for the normal 69kV service to Dover (AEP's East Dover-West Dover 69kV circuit). (S2163)

Estimated Cost: \$0.02 M

Projected In-Service: 12/19/2019

Supplemental Project ID: S2163

Project Status: Engineering

Model: 2024 RTEP

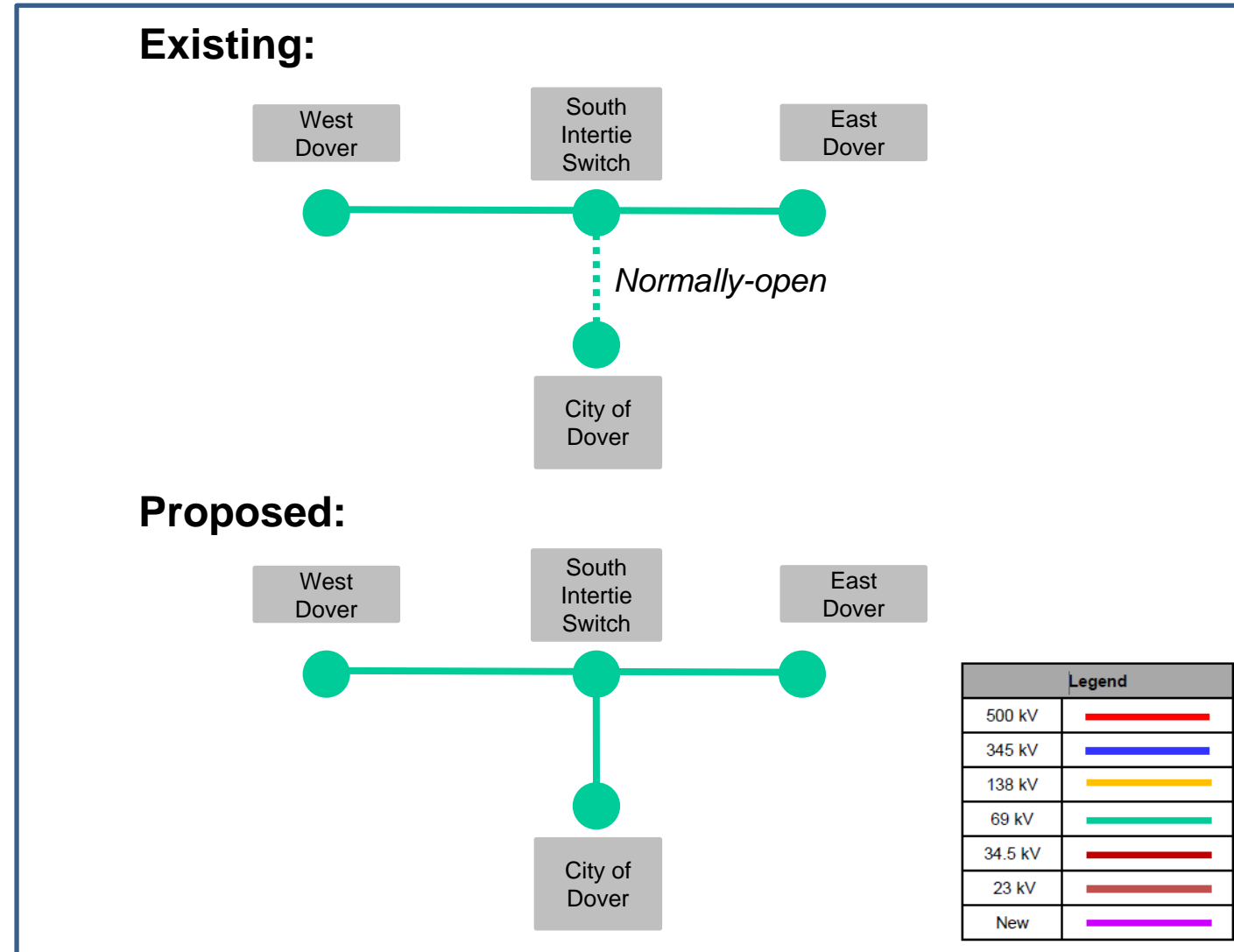

AEP Transmission Zone M-3 Process Delaware CB 114 Replacement

Need Number: AEP-2019-OH062

Process Stage: Submission of Supplemental Project for inclusion in the Local Plan 02/06/2020

Previously Presented:

Needs Meeting 11/22/2019

Solutions Meeting 12/18/2019

Project Driver:

Equipment Condition/Performance/Risk, Operational Flexibility

Specific Assumption Reference:

AEP Guidelines for Transmission Owner Identified Needs (AEP Assumptions Slide 8)

Problem Statement:

Delaware 138kV Station:

Over the last five years Delaware station has accumulated approximately 2 million minutes of customer interruption associated with 19 outages at the station.

138 kV Circuit Breaker 114

- CB 114 is an FK type oil breaker (1964 vintage)
- These are oil breakers that are difficult to maintain due to the required oil handling. There is an increased potential for oil spills during routine maintenance and failures with these types of breakers.
- Other drivers include damage to bushings, spare part availability, historical reliability, and lack of vendor support of the breakers.

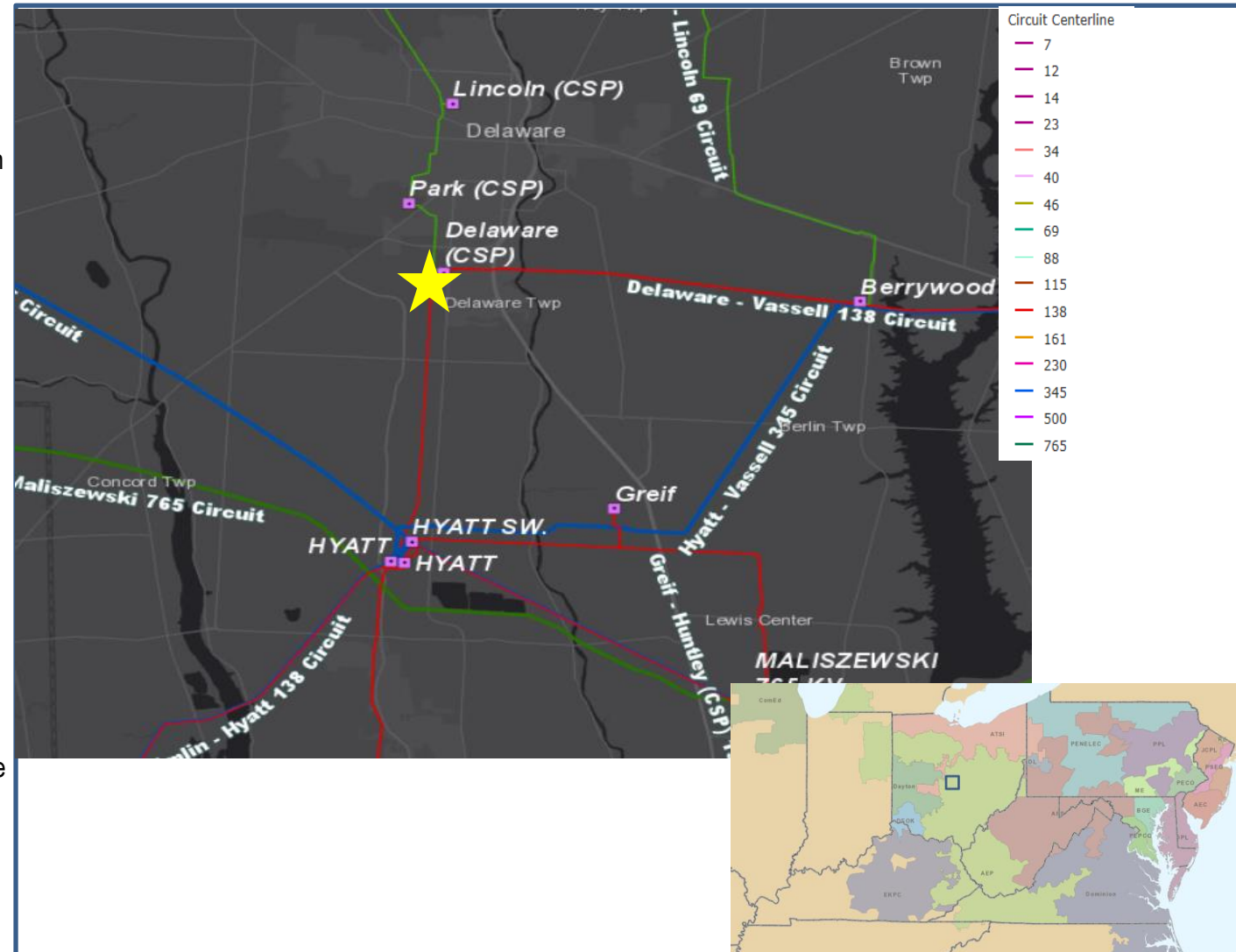

AEP Transmission Zone M-3 Process Delaware CB 114 Replacement

Need Number: AEP-2019-OH062

Process Stage: Submission of Supplemental Project for inclusion in the Local Plan 02/06/2020

Selected Solution:

Replace the line breaker towards Hyatt, CB '114', with a 3000A 40 kA 138 kV circuit breaker, to be done in coordination with the previously approved Delaware – Hyatt 138 kV transmission line rebuild (b3105) – **(S2164)**

Estimated Cost: \$0.5 M

Projected In-Service: 6/1/2021

Supplemental Project ID: S2164

Project Status: Scoping

Model: N/A

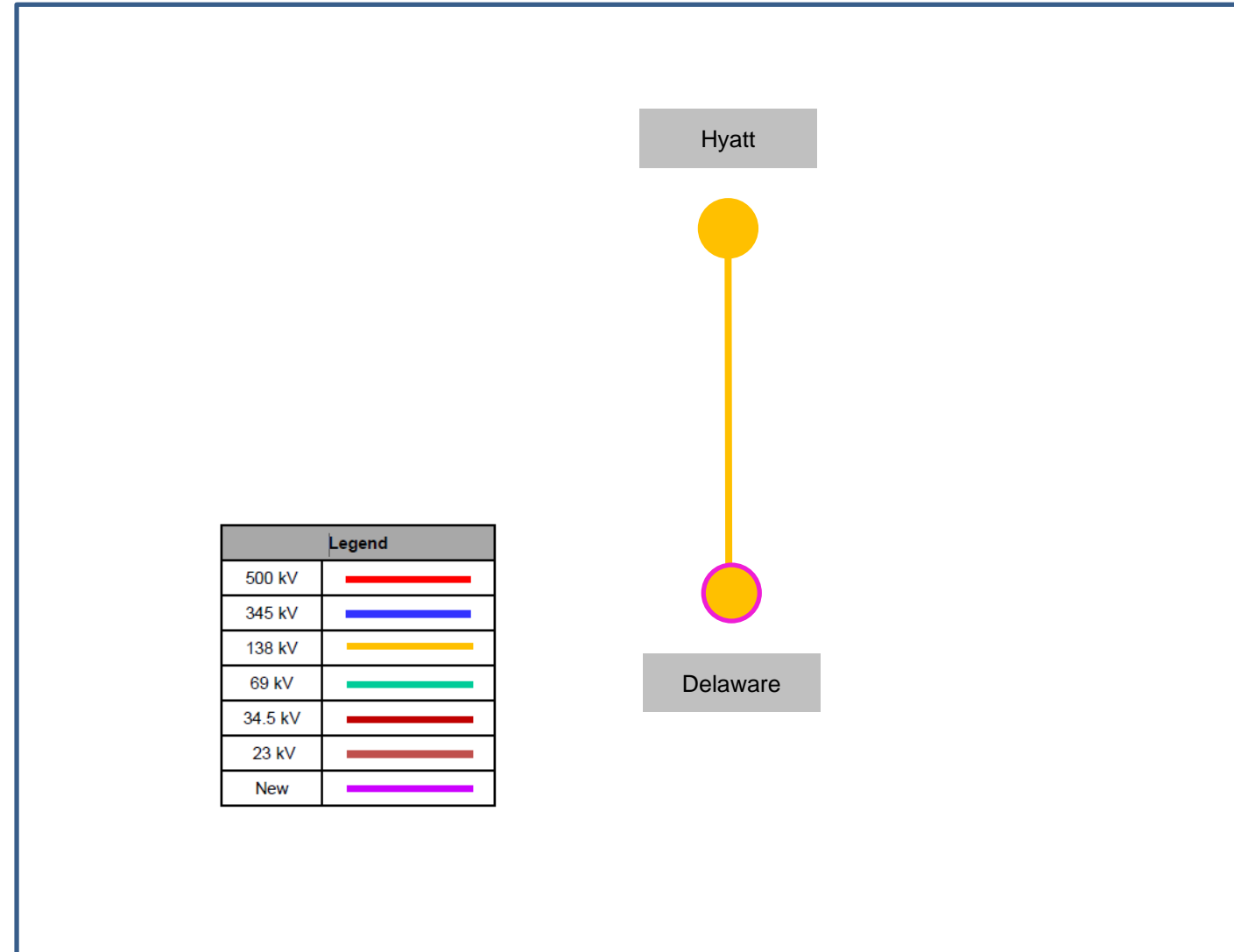

AEP Transmission Zone M-3 Process Stuart Area

Need Number: AEP-2018-AP016

Process Stage: Submission of Supplemental Project for inclusion in the Local Plan 2/27/2020

Previously Presented:

Needs Meeting 1/11/2019

Solutions Meeting 1/17/2020

Project Driver:

Operational Flexibility and Efficiency

Specific Assumption Reference:

AEP Guidelines for Transmission Owner Identified Needs (AEP Assumptions Slide 8)

Problem Statement:

There is approximately a total of 230 MVA of load being served on the 138 kV and 69 kV networks throughout Carroll County, Wythe County, Grayson County and Galax City. Approximately 120 MVA is served off of the 138 kV line from Jacksons Ferry – Huffman – Wythe. The 69 kV network around Cliffview/Galax/Fries serves approximately 110 MVA. Under N-1-1 scenarios involving the 138 kV sources there is the potential to drop all 230 MVA of load.

Originally, AEP proposed supplemental project S1295 to address this concern. Based on recent needs identified in Floyd County VA, AEP believes a more holistic solution exists to resolve these needs collectively. AEP has recommended cancelation of supplemental project S1295 (Presented 5/31/2017 SRTEAC).

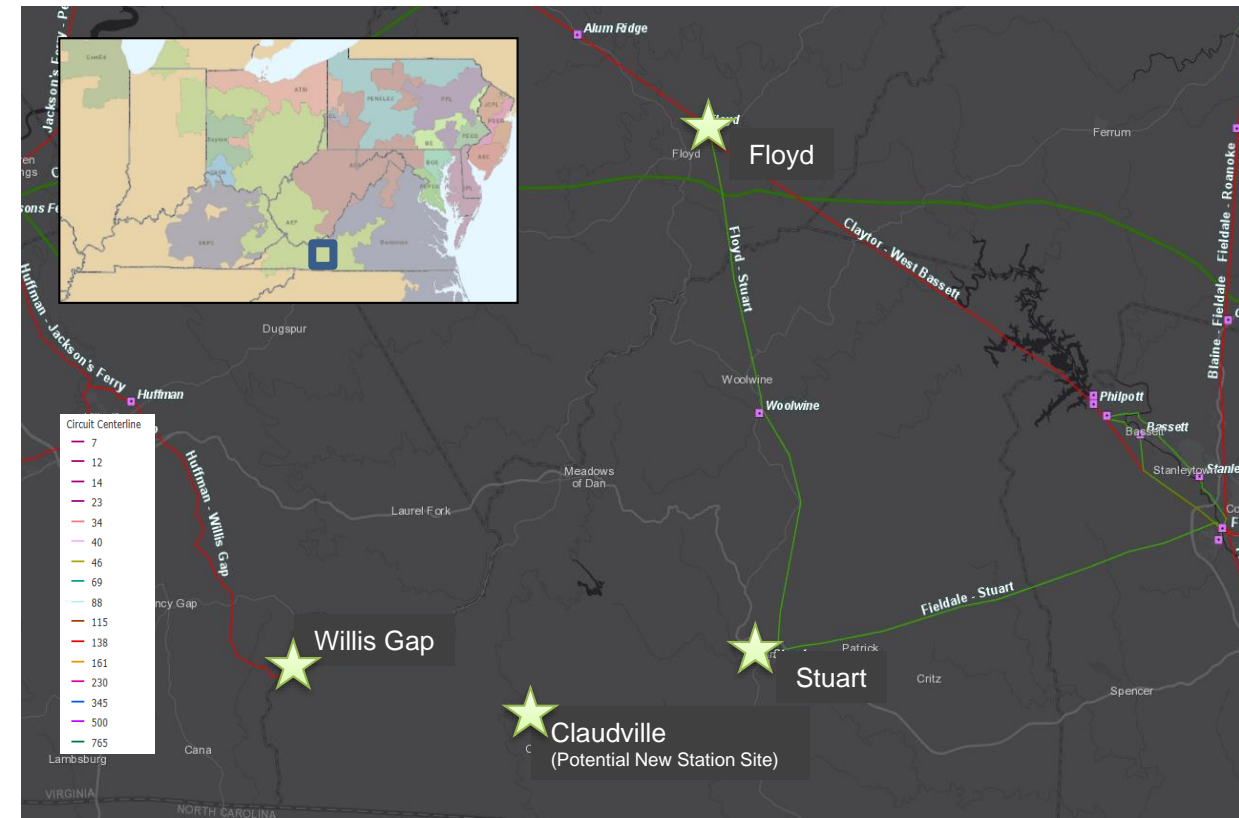

AEP Transmission Zone M-3 Process Stuart Area

Need Number: AEP-2018-AP020

Process Stage: Submission of Supplemental Project for inclusion in the Local Plan 2/27/2020

Previously Presented:

Needs Meeting 1/11/2019

Solutions Meeting 1/17/2020

Project Driver:

Equipment Material/Condition/Performance/Risk

Specific Assumption Reference:

AEP Guidelines for Transmission Owner Identified Needs (AEP Assumptions Slide 8)

Problem Statement:

- The Claytor – West Bassett 138 kV circuit (38.1 mi.) consists primarily of 1948 vintage wood pole structures with 556 ACSR overhead conductor and currently has 255 open conditions on 126 unique structures including rot top, rot heart, broken insulators and woodpecker/insect damage. From 2015-2018, a total of 7 permanent outages resulted in 167,488 customer minutes of interruption.
- The Fieldale – West Bassett 138 kV circuit (6.5 mi.) consists primarily of 1948 vintage wood pole structures with 556 ACSR overhead conductor and currently has 48 open conditions on 29 unique structures which is 71% of the circuit. Conditions include rot top, rot heart and woodpecker damage.
- Fieldale – Stuart 69 kV circuit (19.2 mi.) consists primarily of 1939 vintage wood pole structures and currently has 178 open conditions including broken cross-arms, broken conductor strands, damaged shield wire and woodpecker damage. From 2015-2018, a total of 6 permanent outages and 12 momentary outages were observed.
- Fieldale – West Bassett #1 69 kV circuit (7.1 mi.) consists primarily of 1926 vintage wood pole structures with 4/0 ACSR and 556 ACSR overhead conductor and currently has 23 open conditions on 21 unique structures including rot top, insect damage, broken ground wire, leaning in-line pole and woodpecker damage.
- Fieldale – West Bassett #2 69 kV circuit (6.9 mi.) consists primarily of 1962 vintage wood pole structures with 336 ACSR and 556 ACSR overhead conductor and currently has 20 open conditions on 16 unique structures including rot top, broken cross-arms, insect damage, loose knee brace and woodpecker damage.

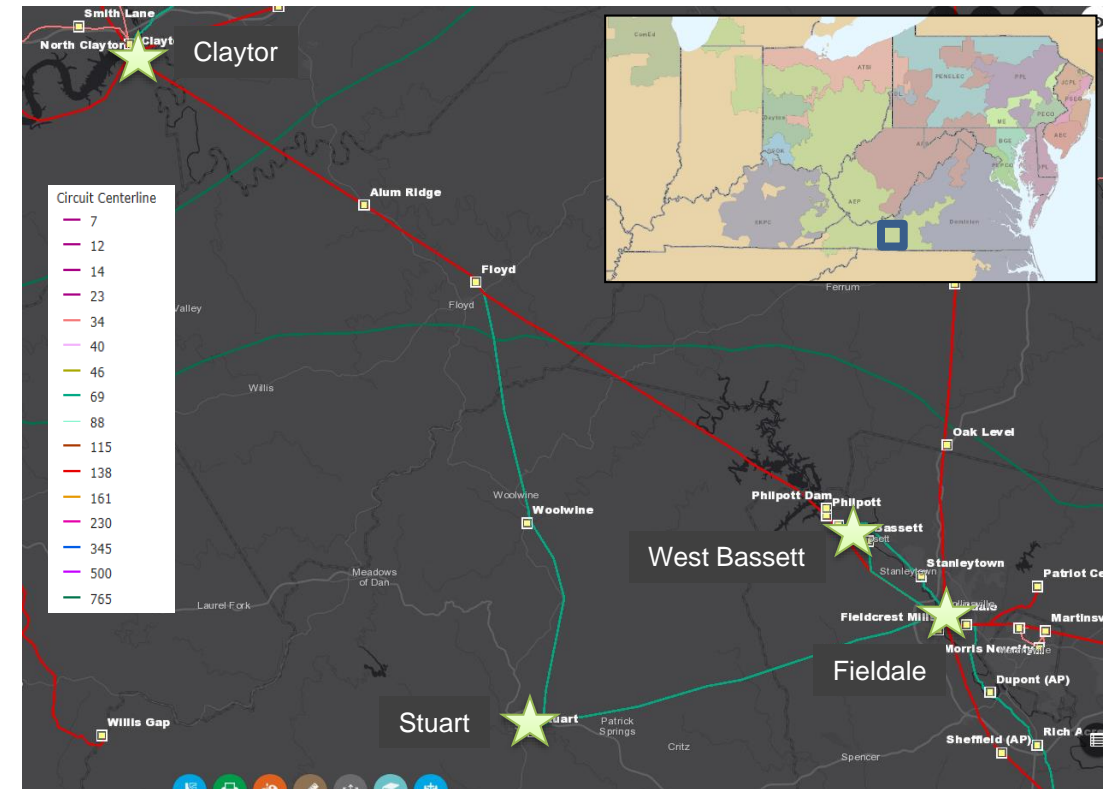

AEP Transmission Zone M-3 Process Stuart Area

Continued from previous slide...

Problem Statement:

Stuart Station

The 69kV CBs D and E are oil filled breakers without secondary oil containment. Oil filled circuit breakers have much more maintenance required due to oil handling that their modern, SF6 counterparts do not require. CBs D and E are 2 of 15 in the FKA-72.5-19000-1 model family remaining on the AEP system. This scarcity of sister units makes finding spare parts for these units unviable, and these models are no longer vendor supported. A malfunction report from 2005 documented that CB D was slow to trip on a lightning fault on the Fieldale-Stuart circuit and that CB F at Floyd cleared it; this report also mentioned that this was the second such occurrence of a low trip for CB D.

The 69kV CS AA is an S&C 2030-69 model. The S&C 2030 circuit switcher model family has no gas monitor and sister units on the AEP System have experienced malfunctions since 1999; the major ones include gas loss, interrupter failures, and operating mechanism failures.

Stuart Substation deploys 48 relays, implemented to ensure the adequate protection and operation of the substation. Currently 45 of the 48 relays (94% of all station relays) are in need of replacement. There are 39 electromechanical type and 3 static type relays with significant limitations in regards to spare part availability in addition to a lack of vendor support and no capability for fault data collection and retention.

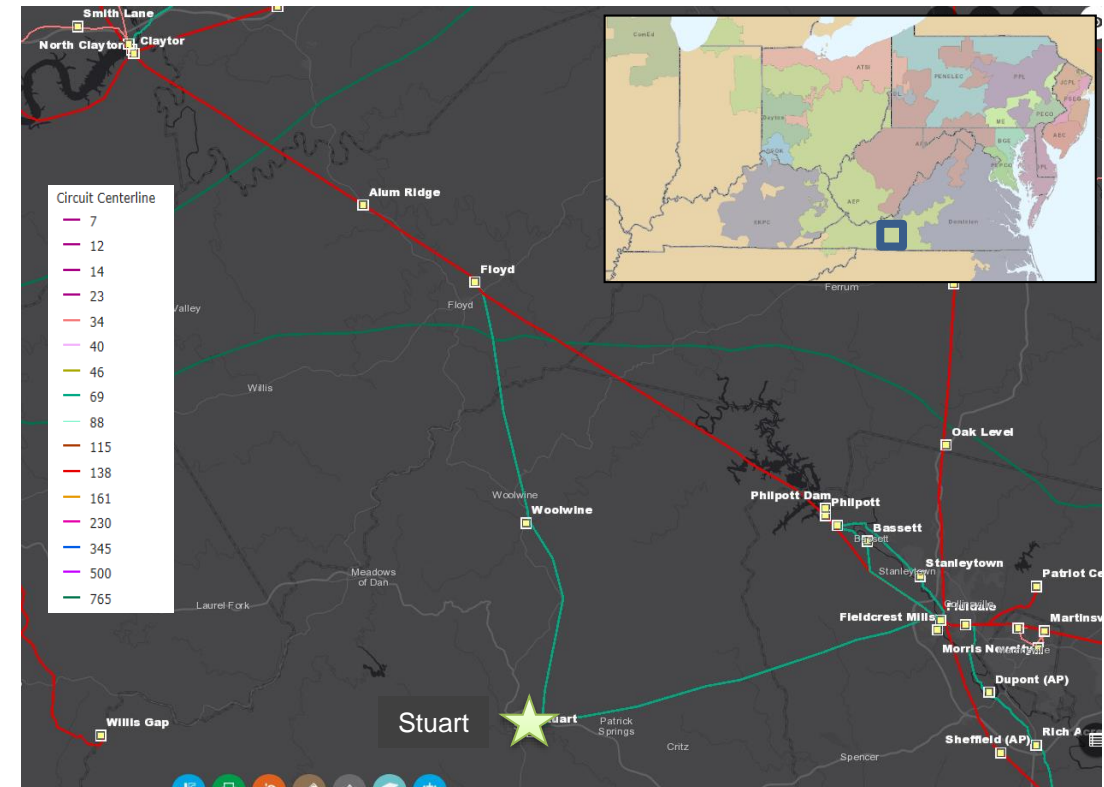

AEP Transmission Zone M-3 Process Stuart Area

Continued from previous slide...

Problem Statement:

West Basset Station

The 138 kV CB A is a GE FK oil type breaker that has seen 77 fault operations over its in-service life. It is one of only 13 remaining of its model type (FK-439-5000) on the entire AEP system; spare parts availability is a major concern. The 72.5 kV CBs J, K, and L are GE FK oil type breakers as well with CB L seeing 40 fault operations over its in-service life. These are three of only 27 remaining of their model type (FK-72.5-27000-1) on the entire AEP system; spare parts availability is a major concern. In addition, these four oil filled breakers have much more maintenance required due to their oil handling than their modern SF6 counterparts do not require.

The 138/69/34 kV transformer #1 has an upward trending of oil moisture content resulting in decreasing oil dielectric strength. Increasing moisture content is a result of water ingress and/or break down of paper insulation of TF windings. The moisture content has since decreased without improvement to the dielectric strength. Short circuit strength breakdown caused by the amount of thermal through fault events, mostly in excess of 700°C, has led to major gassing of the unit and carbonization of the insulating paper.

West Basset Substation currently deploys 62 relays, implemented to ensure the adequate protection and operation of the substation. Currently, 55 of the 62 relays (89% of all station relays) are in need of replacement. There are 53 electromechanical and 2 static type with significant limitations in regards to spare part availability and fault data collection and retention in addition to a lack of vendor support.

Floyd Station

The existing MOAB ground switch design on the high side of transformer #2 needs to be replaced with a circuit switcher to improve the protection scheme and safety of personnel in the station. AEP has been strategically targeting ground switch MOABs for replacement due to the burden that these devices place on Transmission circuit breakers for clearing Distribution Transformer faults.

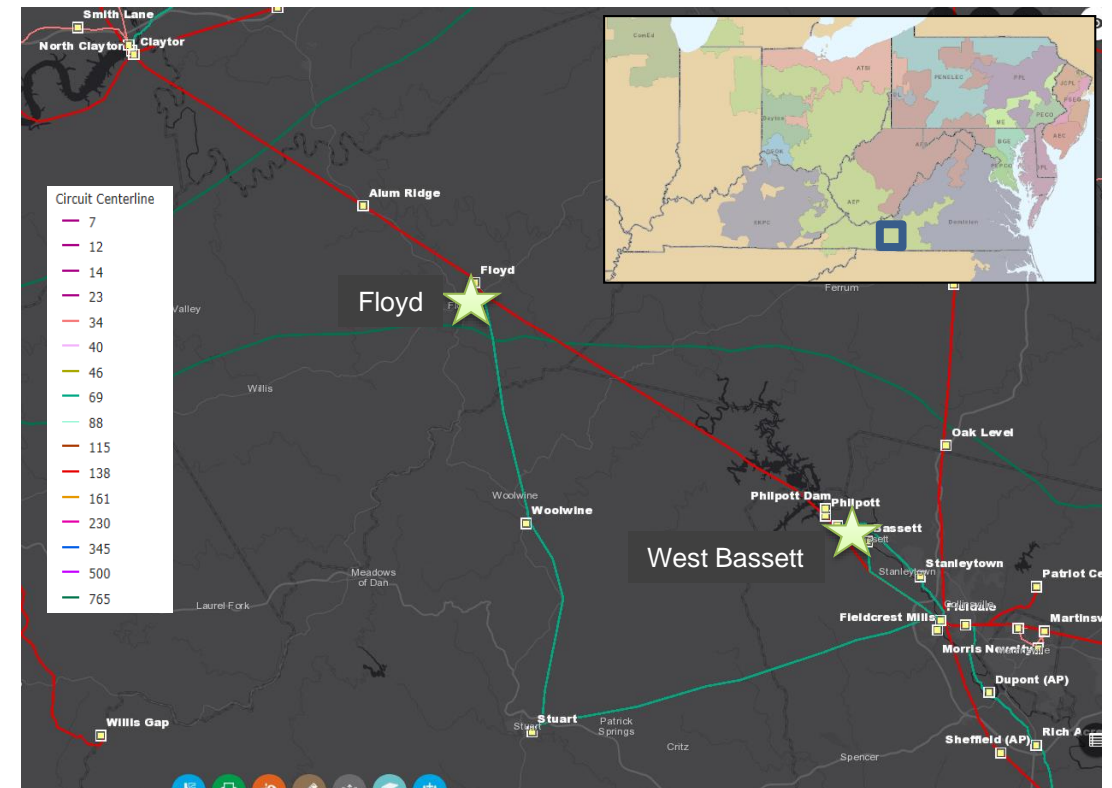

AEP Transmission Zone M-3 Process Stuart Area

Need Number: AEP-2019-AP036

Process Stage: Submission of Supplemental Project for inclusion in the Local Plan 2/27/2020

Previously Presented:

Needs Meeting 9/25/2019

Solutions Meeting 1/17/2020

Project Driver:

Equipment Material/Condition/Performance/Risk

Specific Assumption Reference:

AEP Guidelines for Transmission Owner Identified Needs (AEP Assumptions Slide 8)

Problem Statement:

- The Floyd-Stuart 69 kV circuit (21.0 mi.) was originally built in 1939 consisting of wood pole structures and predominately 4/0 ACSR 4/1 overhead conductor. 88% of the wood poles are 1939 vintage. Core drilling shows significant loss of material in wood poles due to decay and woodpeckers. The overhead conductor and shield wires are greater than 65 years old, exceeding the recommended lifespan of these components. Between January 2014 and March 2019, 9 momentary and 2 permanent outages have occurred on this circuit. There are 52 open conditions mainly from woodpecker and wood rot.

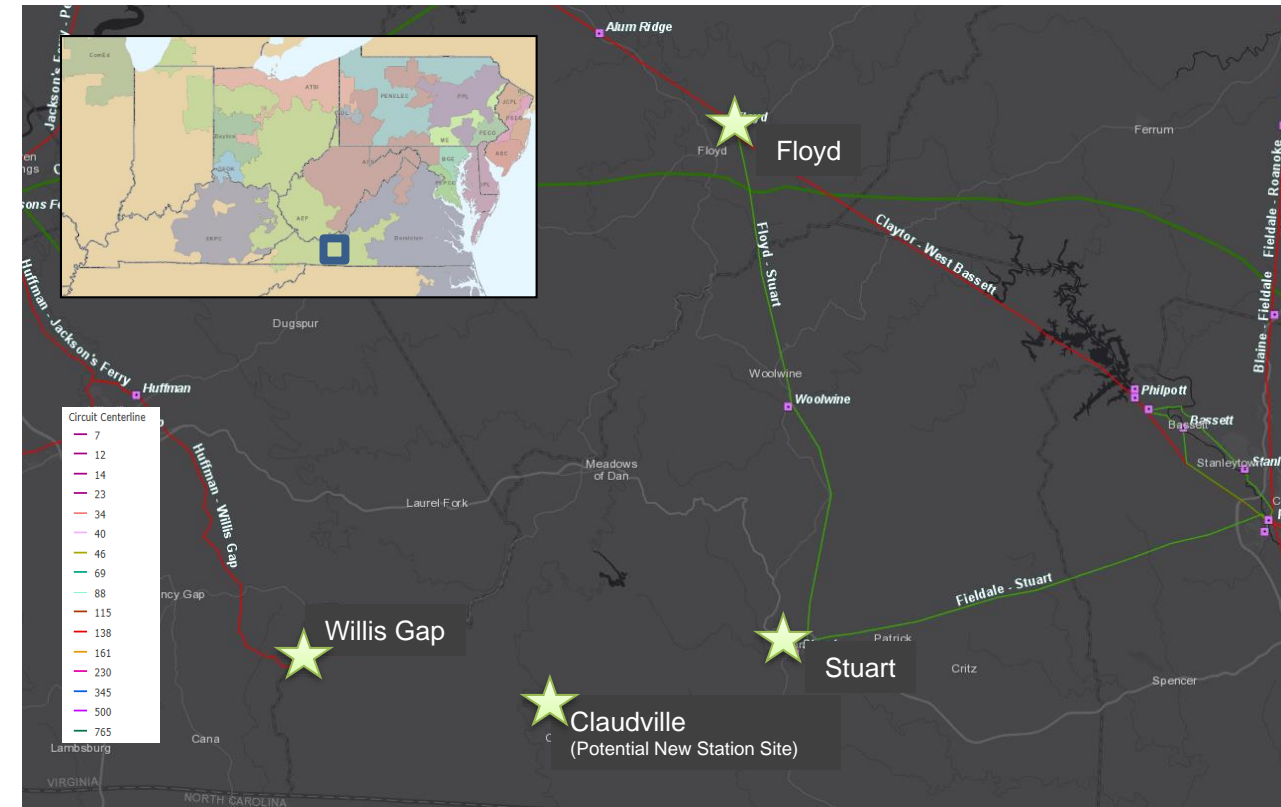

AEP Transmission Zone M-3 Process Stuart Area

Need Number: AEP-2019-AP038

Process Stage: Submission of Supplemental Project for inclusion in the Local Plan 2/27/2020

Previously Presented:

Needs Meeting 9/25/2019

Solutions Meeting 1/17/2020

Project Driver:

Equipment Material/Condition/Performance/Risk

Specific Assumption Reference:

AEP Guidelines for Transmission Owner Identified Needs (AEP Assumptions Slide 8)

Problem Statement:

- Distribution has requested the need for a new Claudville Station located between the existing Willis Gap and Stuart stations in order to decrease the exposure to lengthy 34.5 kV distribution circuits fed from Willis Gap and Stuart stations. A new distribution station source will allow for the opportunity to establish two new 34.5 kV feeders by splitting up the Willis Gap/Ararat (174 line miles) and the Stuart/Carroll (267 line miles) distribution feeders. The Willis Gap 138/34.5 kV #1 transformer is projected to be loaded to 28.4 MVA, or 101% of its 28.0 MVA capability by winter 2022-23. The new Claudville station will alleviate this projected overload.

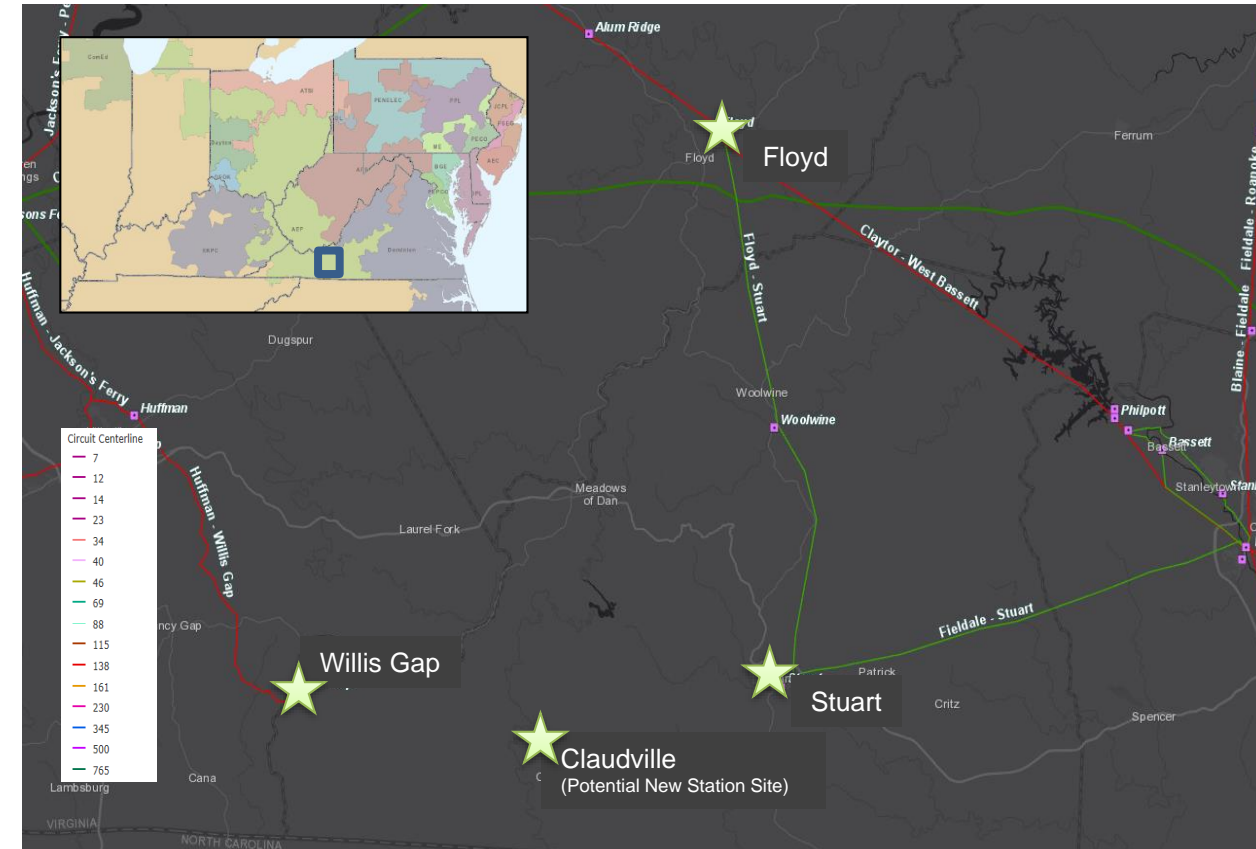

AEP Transmission Zone M-3 Process Stuart Area

Need Number: AEP-2018-AP016, AEP-2018-AP020, AEP-2019-AP036, AEP-2019-AP037, AEP-2019-AP038

Process Stage: Submission of Supplemental Project for inclusion in the Local Plan 2/27/2020

Selected Solution:

- Construct ~12.5 miles 138 kV line from Alum Ridge to Claytor. **(S2179.1) Estimated Cost: \$34.3M**
- Construct ~6.5 miles 138 kV line from Alum Ridge to Floyd. **(S2179.2) Estimated Cost: \$20.6M**
- Construct ~7 miles of 138 kV line from Fieldale-Fairystone. **(S2179.3) Estimated Cost: \$17.6M**
- Construct ~1.25 miles of double circuit 138 kV line to connect Stanleytown. **(S2179.4) Estimated Cost: \$5.3M**
- Construct 0.07 miles of 138 kV line from Bassett Switch-Bassett. **(S2179.5) Estimated Cost: \$1.5M**
- Construct ~1.2 miles of 138 kV line from Philpott Dam-Fairystone. **(S2179.6) Estimated Cost: \$3.6M**
- Construct ~22 miles of 138 kV line from Salem Highway to Willis Gap. **(S2179.7) Estimated Cost: \$65.0M**
- Construct ~21 miles of 138 kV line from Salem Highway-Fairystone. **(S2179.8) Estimated Cost: \$60.0M**
- Construct ~11 miles of 138 kV line from Floyd-Woolwine. **(S2179.9) Estimated Cost: \$29.2M**
- Construct ~10 miles of 138 kV line from Salem Highway to Woolwine. **(S2179.10) Estimated Cost: \$29.6M**
- Remove ~11 miles of 69 kV line from Floyd-Woolwine. **(S2179.11) Estimated Cost: \$1.3M**
- Remove ~10 miles of 69 kV line from Stuart-Woolwine. **(S2179.12) Estimated Cost: \$4.8M**
- Remove ~12.2 miles of 138 kV line from Alum Ridge-Claytor. **(S2179.13) Estimated Cost: \$1.2M**
- Remove ~6.25 miles of 138 kV line from Alum Ridge-Floyd. **(S2179.14) Estimated Cost: \$0.8M**
- Remove ~19 miles of 138 kV line from Floyd-West Bassett. **(S2179.15) Estimated Cost: \$12.1M**
- Remove ~6.4 miles of 138 kV line from Fieldale-West Bassett. **(S2179.16) Estimated Cost: \$2.9M**
- Remove ~0.34 miles of 138 kV line from Philpott SS-Philpott. **(S2179.17) Estimated Cost: \$0.1M**
- Remove ~19 miles of 69 kV line from Fieldale to Stuart. **(S2179.18) Estimated Cost: \$8.3M**
- Remove ~7.1 miles of 69 kV line from Fieldale to West Bassett. **(S2179.19) Estimated Cost: \$10.1M**
- Remove ~6.8 miles of 69 kV line from Fieldale to West Bassett. **(S2179.20) Estimated Cost: \$9.5M**

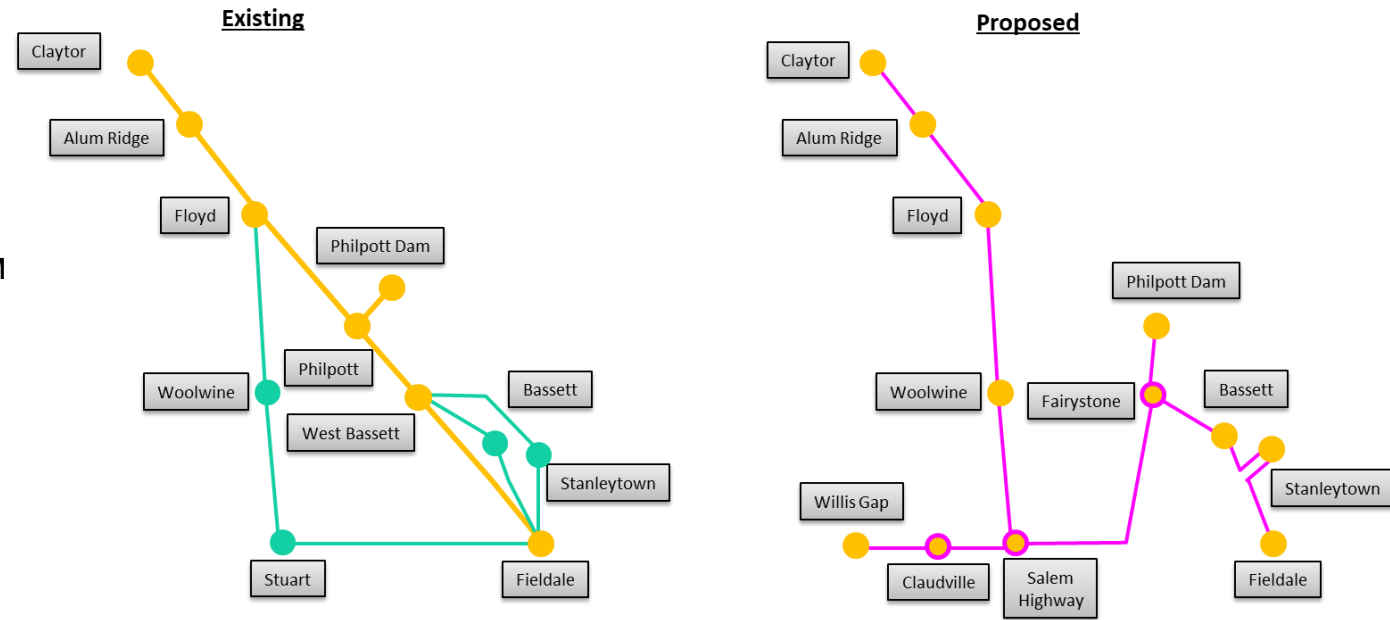

Legend	
500 kV	
345 kV	
138 kV	
69 kV	
34.5 kV	
23 kV	
New	

AEP Transmission Zone M-3 Process Stuart Area

Continued from previous slide...

- At Floyd station, install 2-138 kV circuit breakers (3000 A, 40 kA). Install high-side circuit switcher on T2 (3000A, 40 kA). Station expansion to accommodate new equipment and DICM. Install 138 kV line relaying, CCVT's, breaker controls, bus differential protection, transformer #2 protection. **(S2179.21) Estimated Cost: \$6.0M**
- At Fieldale station, retire 69 kV CB G, D and C. Install CCVTs and arresters on 138 kV West Bassett Line. **(S2179.22) Estimated Cost: \$0.7M**
- At Bassett switch, install 138 kV Switch with 2-138 kV MOABs. **(S2179.23) Estimated Cost: \$0.5M**
- At Bassett station, convert station from 69 kV to 138 kV. Install 138/12 kV transformer with high-side circuit switcher, transclosure and associated distribution feeders. **(S2179.24) Estimated Cost: \$0M**
- At Claytor station, install line relaying. Remove wavetrap, replace 1590 AAC risers. **(S2179.25) Estimated Cost: \$0.9M**
- Retire Philpott 138 kV switch structure. **(S2179.26) Estimated Cost: \$0.3M**
- At Willis Gap station, install 2-138 kV MOABs. Terminate new Salem Highway-Willis Gap 138 kV line. **(S2179.27) Estimated Cost: \$0M**
- At Woolwine station, convert station from 69 kV to 138 kV. Retire/remove 69 kV switch structure, 69 kV MOABs, 69/34.5 kV transformer. Install 138 kV 3-way switch structure with MOABs, 138/34.5 kV transformer with high-side circuit switcher. **(S2179.28) Estimated Cost: \$0M**
- At Salem Highway station, establish new 138 kV station replacing Stuart Station. Install 138 kV 5-breaker ring bus, 138/34.5 kV & 138/12 kV transformers with high-side circuit switchers. Terminate Huffman, Floyd and Fairystone 138 kV circuits. **(S2179.29) Estimated Cost: \$0M**
- At Stuart station, retire and remove all existing equipment and control house. **(S2179.30) Estimated Cost: \$0M**
- At Stanleytown station, convert station from 69 kV to 138 kV. Retire/remove 69 kV switch structure, 69 kV MOABs, 69/12 kV transformer. Install 138 kV 3-way switch structure with MOABs, 138/12 kV transformer with high-side circuit switcher. **(S2179.31) Estimated Cost: \$0M**

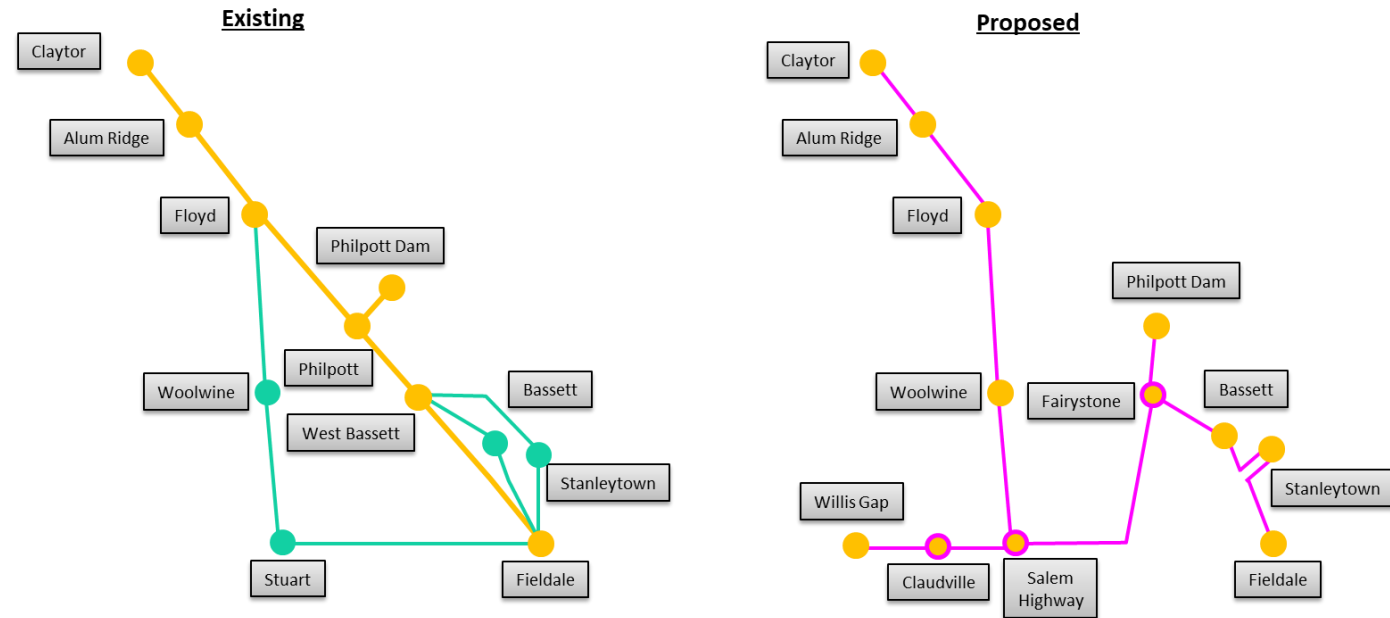

Legend	
500 kV	—
345 kV	—
138 kV	—
69 kV	—
34.5 kV	—
23 kV	—
New	—

AEP Transmission Zone M-3 Process Stuart Area

Continued from previous slide ...

- At Fairystone station, establish new 138 kV station replacing West Bassett. Install 138 kV 4-breaker ring bus, 138/34.5 kV transformer with high-side circuit switcher and associated distribution feeders. Terminate Salem Highway, Fieldale and Philpott Dam 138 kV circuits. **(S2179.32) Estimated Cost: \$0M**
- At Claudville station, establish new 138/34.5 kV distribution station with 2-138 kV CBs, 138/34.5 kV transformer and 3-34.5 kV feeders. **(S2179.33) Estimated Cost: \$0M**
- Provide transition, entry and termination for OPGW connectivity at Willis Gap, Claytor, Alum Ridge, Floyd, Woolwine, Stuart, Fairystone, Philpott Dam, Bassett, Stanleytown, Fieldale, and Salem Highway to support fiber relaying. **(S2179.34) Estimated Cost: \$0.7M**

Ancillary Benefits: The new Salem Highway-Willis Gap 138 kV line provides an additional support to both the Galax area and the Stuart area during contingency scenarios.

Total Estimated Transmission Cost: \$326.9M

Projected In-Service: 10/31/2027

Supplemental Project ID: S2179.1-.34

Project Status: Scoping

Model: N/A

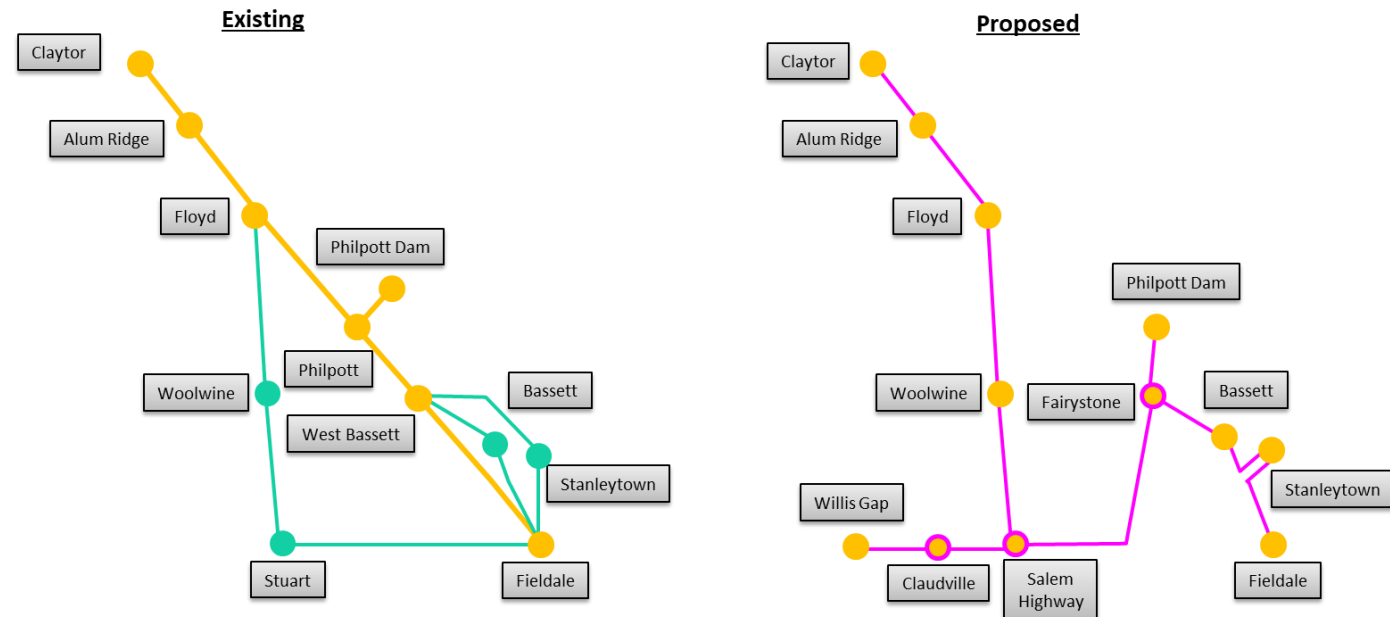

Legend	
500 kV	
345 kV	
138 kV	
69 kV	
34.5 kV	
23 kV	
New	

AEP Transmission Zone M-3 Process Carbondale – Kincaid Rebuild

Need Number: AEP-2019-AP026

Process Stage: Submission of Supplemental Project for inclusion in the Local Plan 2/27/2020

Previously Presented:

Needs Meeting 7/24/2019

Solutions Meeting 1/17/2020

Project Driver:

Equipment Condition/Performance/Risk, Operational Flexibility and Efficiency

Specific Assumption Reference:

AEP Guidelines for Transmission Owner Identified Needs (AEP Assumptions Slide 8)

Problem Statement:

Carbondale – Kincaid 46 kV #1 (~14.8 miles)

- Majority of the circuit is constructed with 1950s wood and lattice structures
- The conductor is greater than 65 years old. Grounding on this line does not meet current standards.
- Between 2015-2018 the circuit experienced 16 momentary and 6 permanent outage resulting in approximately 140k customer minutes of interruption

Carbondale – Kincaid 46 kV #2 (~18.6miles)

- Majority of the circuit is constructed with 1950s wood and lattice structures
- The conductor is greater than 65 years old. Grounding on this line does not meet current standards.
- From 2015-2018 the circuit has experienced 16 momentary and 7 permanent outages resulting in approximately 390k customer minutes of interruption

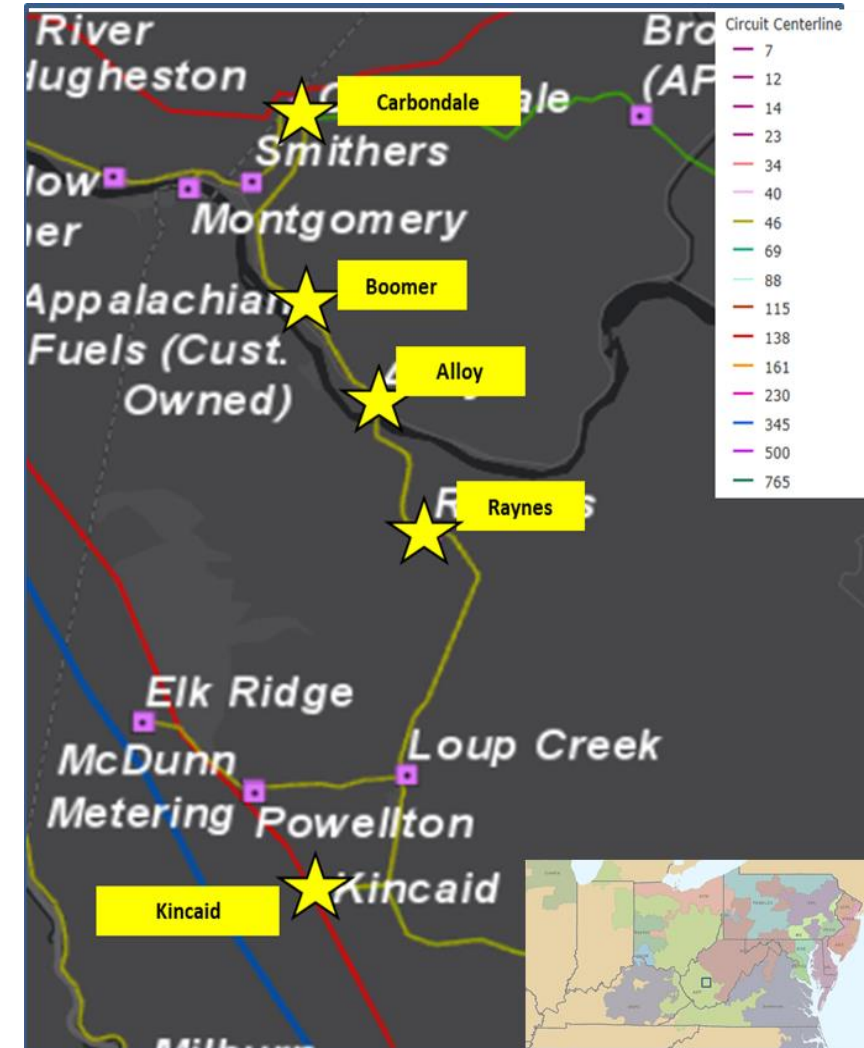

AEP Transmission Zone M-3 Process

Carbondale – Kincaid Rebuild

Problem Statement (cont'd):

Carbondale 138/69/46 kV Station

- 46 kV and 69 kV CBs A, B, C, D, F and G are all 1968, CF-48-69-2500 type breakers.
 - Spare parts for these units are difficult to impossible to obtain, and this model type is no longer vendor supported
 - These breakers are oil filled without oil containment; oil filled breakers have much more maintenance required due to oil handling
 - These breakers have each exceeded the designed number of full fault operations (10). CB-A: 154, CB-B: 49, CB-C: 78, CB-D: 75, CB-F: 94, CB-G: 100
- Carbondale 138/69/46 kV TR-1, manufactured in 1972, has experienced a sharp increase in combustible gas concentrations in January 2016.
 - Numerous gasses have remained at elevated levels, including acetylene at IEEE Condition 4 and ethylene at IEEE Condition 2.
 - The concentrations present are strongly correlated to electrical discharges of high energy and thermal faults in excess of 700°C.
 - Despite declining moisture levels and improving interfacial tension, oil power factor levels are on the rise, and dielectric strength is declining. This supports contamination in the oil from the high energy discharges and thermal faults.
- The current MOAB/Ground SW configuration on TR-1 creates a fault in the station to signal the remote end breakers to open; this is a known safety hazard in legacy station designs.
- The 138 kV line section towards Kanawha River terminates directly into the bus which creates a lack of operational flexibility when switching for faults on the circuit.
- Carbondale Substation currently deploys 64 relays, implemented to ensure the adequate protection and operation of the substation.
 - 36 of the 64 relays (56% of all station relays) are in need of replacement.
 - 36 of the electromechanical which have significant limitations with regards to fault data collection and retention. Spare parts for these relays are difficult to obtain.

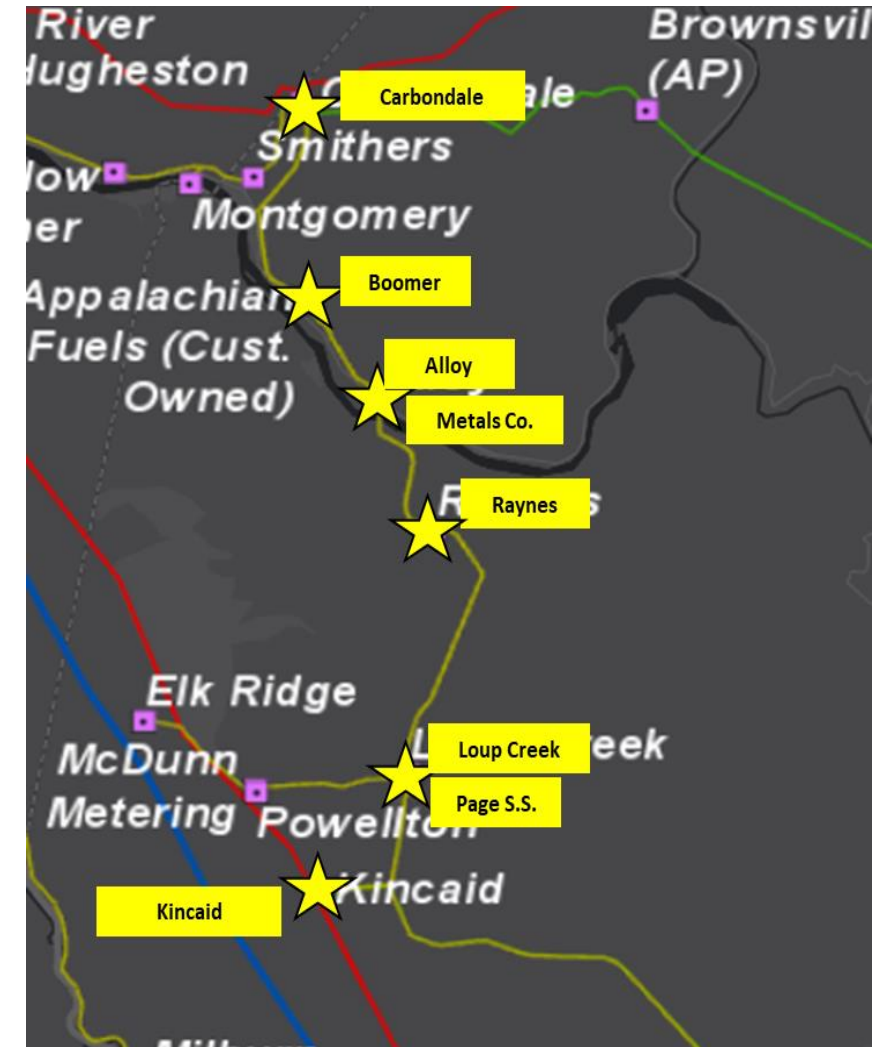

AEP Transmission Zone M-3 Process Carbondale – Kincaid Rebuild

Problem Statement (cont'd):

Kincaid 138/69/46 kV Station

- 46kV CBs A, B, and J are all 1972 FK-72.5-27000-9 type breakers, accounting for 3 of 21 remaining of this model remaining on the AEP system.
 - Spare parts for these units are not available and this model type is no longer vendor supported
 - These breakers are oil filled without oil containment; oil filled breakers have much more maintenance required due to oil handling
 - These breakers have each exceeded the designed number of full fault operations (10). CB-A: 61, CB-B: 123, CB-J: 72
- GND TR PH 1-3
 - All three single phase units of GND TR are experiencing similar health deterioration.
 - There are elevated levels of Acetylene at IEEE condition 2 and Carbon Dioxide at IEEE Condition 2 or 3.
 - The presence of excess acetylene may be a product of arcing causing overheating on this unit. High levels of carbon dioxide support this observation.
 - In addition, significantly diminished oil interfacial tension corroborates the frequent overheating events. Sludge has likely developed in the oil from particulate formation during arcing and other fault events. This sludge impairs the natural circulation of oil.
 - Moisture levels are on the rise which can lead to diminished dielectric strength over time.
- The current 138 kV MOAB/Ground SW configuration on TR-1 creates a fault in the station to signal the remote end breakers to open; this is a known safety hazard in legacy station designs.

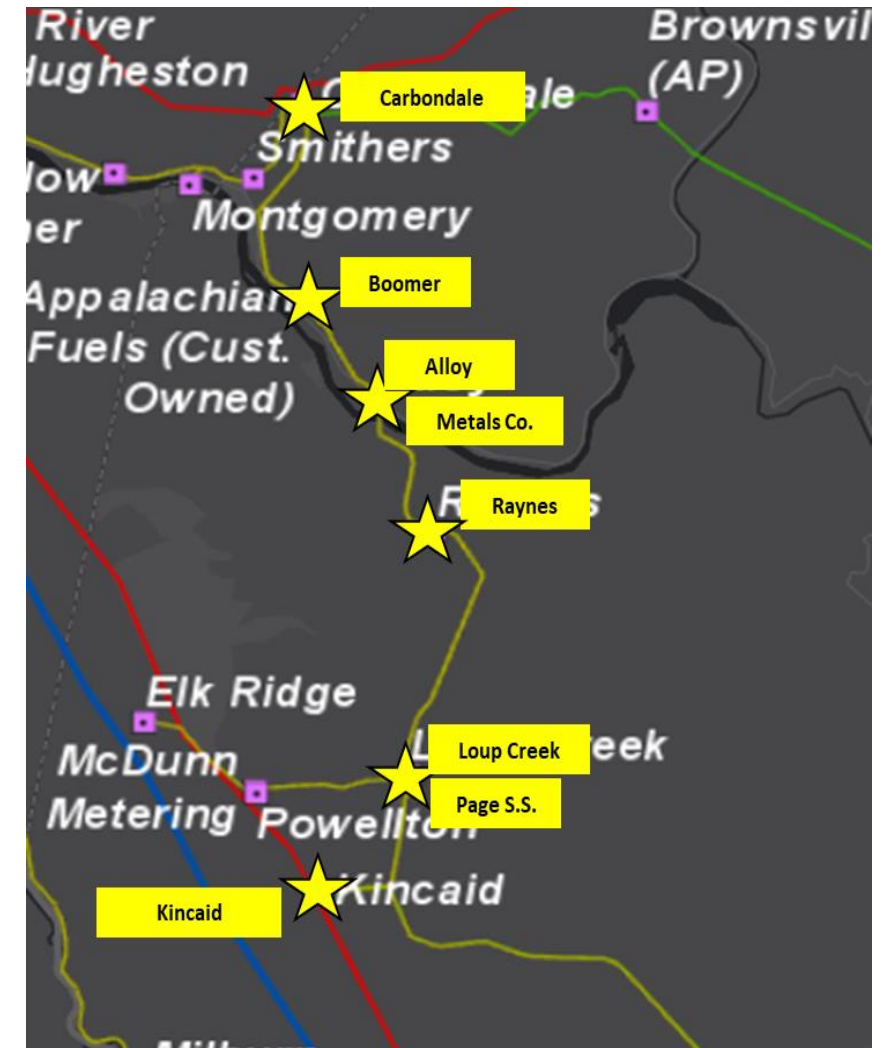

AEP Transmission Zone M-3 Process Carbondale – Kincaid Rebuild

Problem Statement (cont'd):

- Kincaid Substation currently deploys 51 relays, implemented to ensure the adequate protection and operation of the substation.
 - Currently, 45 of the 51 relays (88% of all station relays) are in need of replacement.
 - There are 45 of the electromechanical which have significant limitations with regards to fault data collection and retention. Of these relays, 18 are in the top 90th percentile of relays on the AEP system targeted for replacement by PCE.
 - There appears to be little room in the existing control house to accommodate a relay replacement of this suggested magnitude.
- The existing RTU installed at Kincaid is a GE D200MEII/Ethernet and has 2 documented malfunction records

Boomer 46 kV Station

- Customer no longer served from this station, no load at this station.

Raynes 46 kV Station

- Customer no longer served from this station, no load at this station.

Alloy 46 kV Station Hard Tap

- Hard taps are difficult to maintain due to required outages or temporary jumper configurations in lieu of a switch.
- Hard taps can also result in extended outages to customers due to the inability to sectionalize faulted facilities.

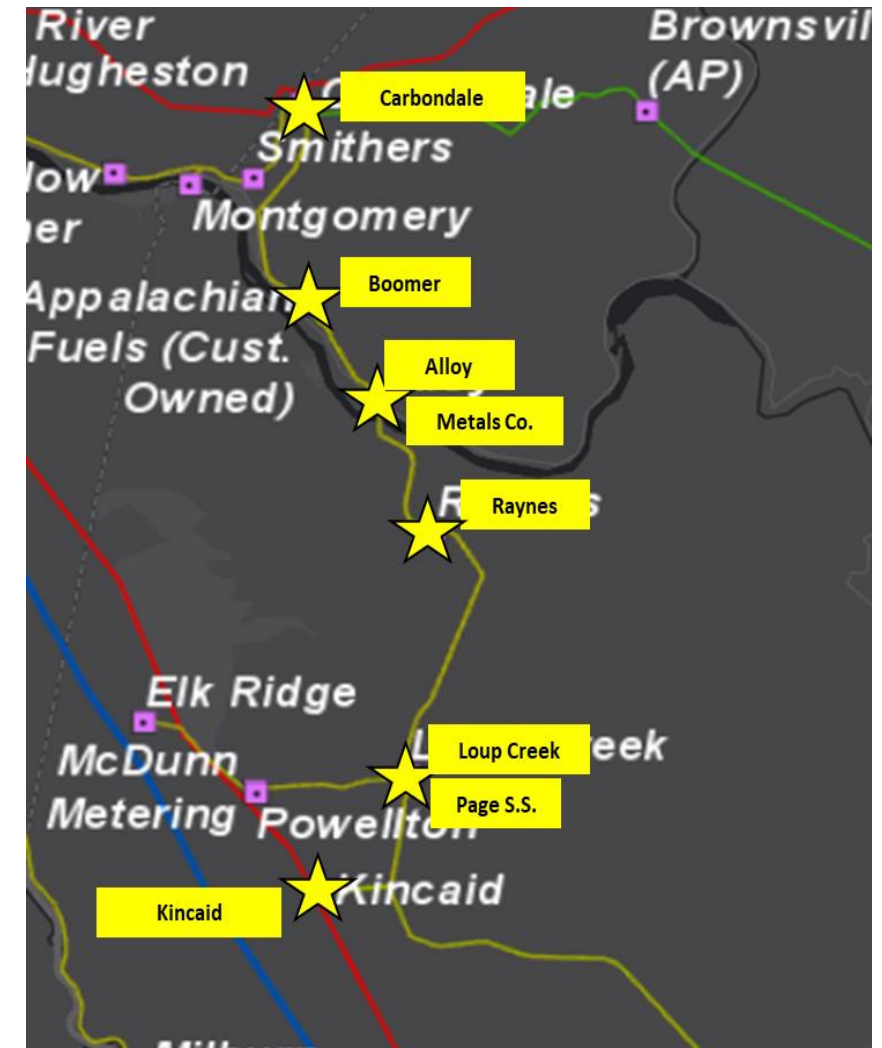

AEP Transmission Zone M-3 Process Carbondale - Kincaid

Need Number: AEP-2019-AP026

Process Stage: Submission of Supplemental Project for inclusion in the Local Plan 2/27/2020

Selected Solution:

Rebuild the Carbondale – Kincaid 46 kV lines as a single circuit 46 kV line (~16.3 miles). **(S2177.1) Estimated Trans. Cost: \$50.7M**

Retire the Carbondale – Kincaid #1/#2 double circuit 46 kV line. **(S2177.2) Estimated Trans. Cost: \$9.1M**

Alloy Station: Install a 2-way switch to address hard tap. **(S2177.3) Estimated Trans. Cost: \$0.9M**

Page S.S.: Replace existing switch to accommodate new line. **(S2177.4) Estimated Trans. Cost: \$0.3M**

Raynes Meter Station: Remove/retire station. **(S2177.5) Estimated Trans. Cost: \$0.3M**

Boomer Station: Remove/retire station. **(S2177.6) Estimated Trans. Cost: \$0.1M**

Carbondale Station: Replace existing circuit breakers A and G with two new 69 kV circuit breakers. Replace existing 46 kV circuit breakers B, C and F. Retire 46 kV circuit breaker D. Install two new 138 kV circuit breakers and a high side circuit switcher. Replace existing 138/69/46 kV 115 MVA transformer with a new 138/69/46 kV 130 MVA transformer. 138 kV line work needed to accommodate the station work. **(S2177.7) Estimated Trans. Cost: \$11.4M**

Kincaid Station: Replace existing circuit breakers A and B with two new 46 kV circuit breakers. Retire circuit breaker J. Replace existing ground transformer bank with a new ground transformer bank. Install a new high side circuit switcher to replace the existing ground sw. MOAB on the high side of the transformer. **(S2177.8) Estimated Trans. Cost: \$3.7M**

Total Estimated Transmission Cost: \$76.5M

Projected In-Service: 11/1/2022

Supplemental Project ID: S2177.1-.8

Project Status: Scoping

Model: N/A

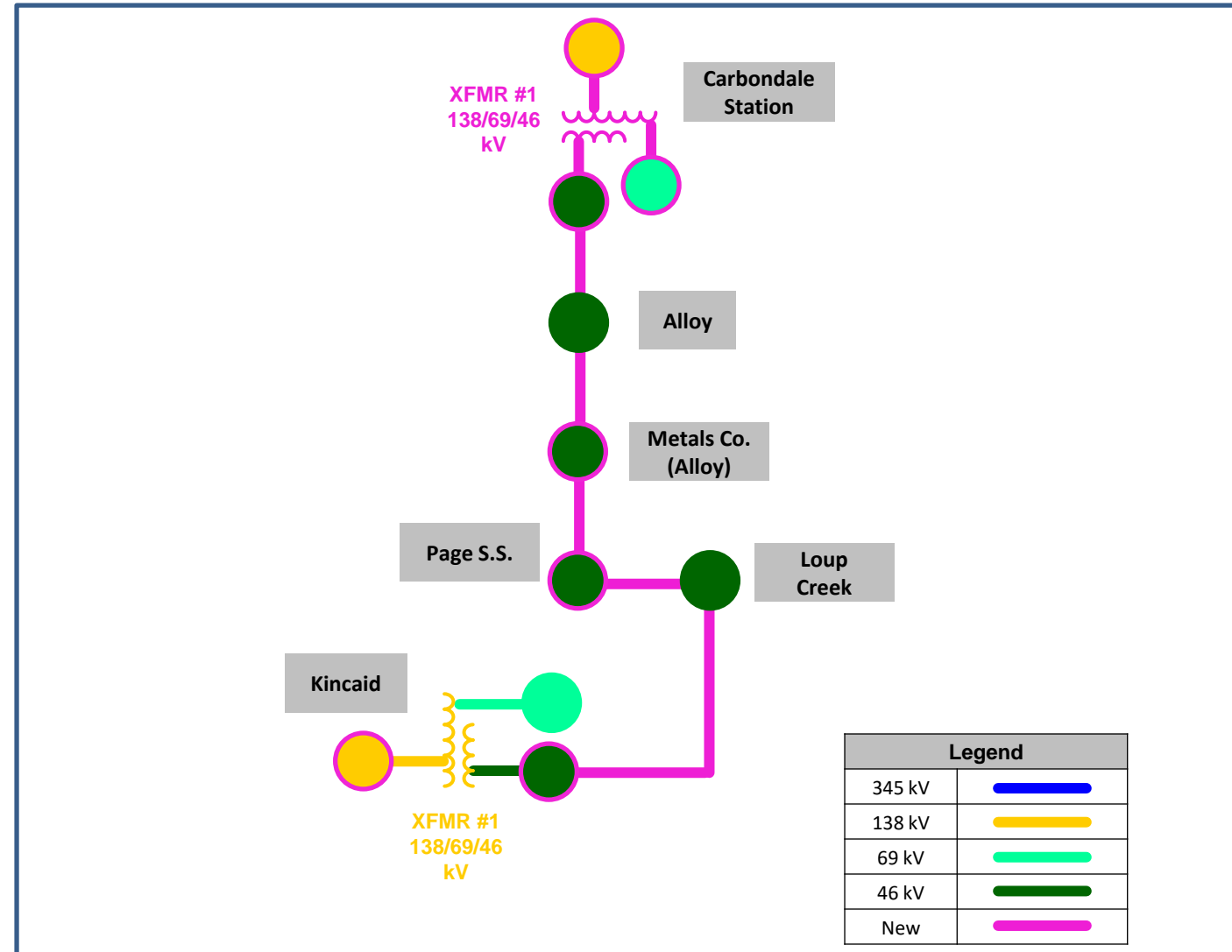

AEP Transmission Zone M-3 Process Kenna Station

Need Number: AEP-2019-AP034

Process Stage: Submission of Supplemental Project for inclusion in the Local Plan 2/27/2020

Previously Presented:

Needs Meeting 9/25/2019

Solutions Meeting 1/17/2020

Project Driver:

Equipment Condition/Performance/Risk

Specific Assumption Reference:

AEP Guidelines for Transmission Owner Identified Needs (AEP Assumptions Slide 8)

Problem Statement:

The Amos – Sisson 138 kV line is a 16 mile long radial line and maintenance cannot be performed due to length of outages required. Approximately 18 MVA is served out of Lanham and 25 MVA is served out of Sisson during winter peak conditions and will be dropped for outages on this circuit. Customers served out of the area are concerned and are requesting that we take necessary steps to ensure reliability.

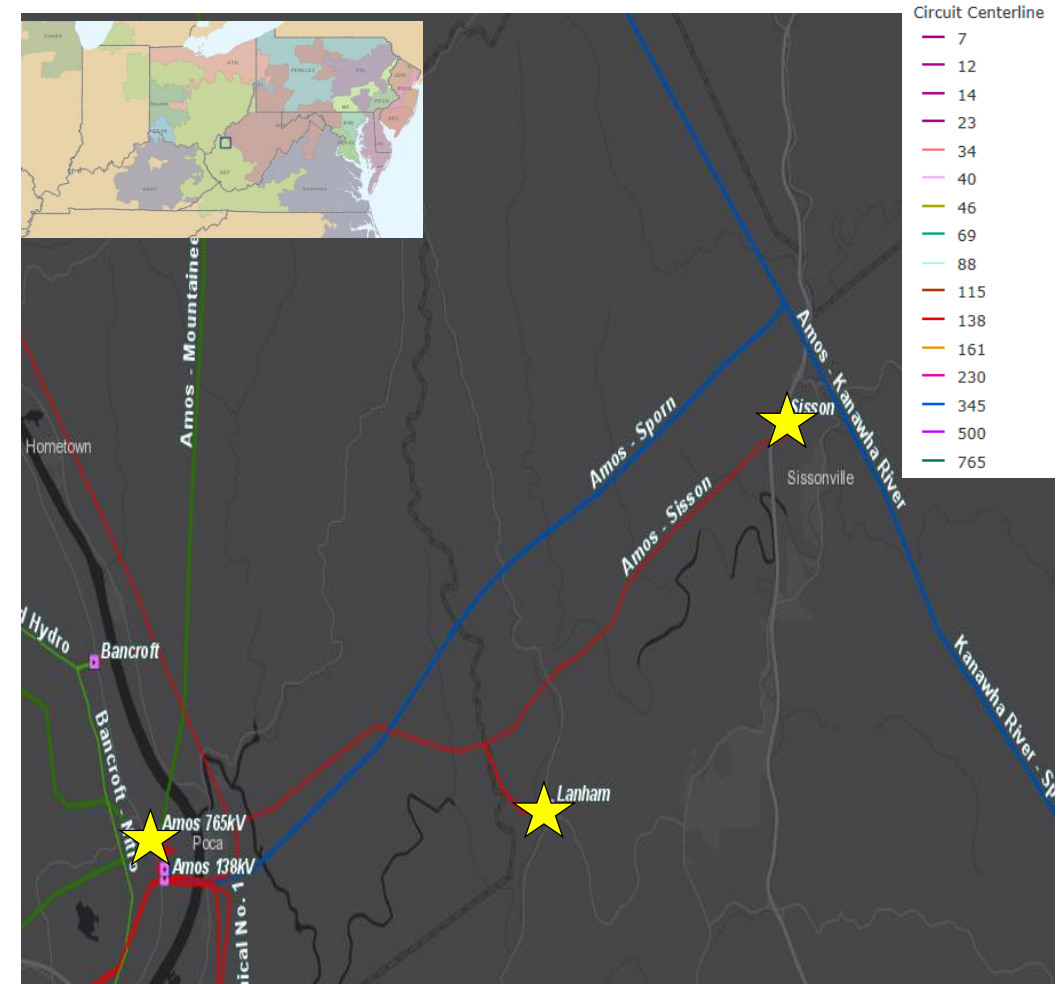

AEP Transmission Zone M-3 Process Kenna Station

Need Number: AEP-2019-AP035

Process Stage: Submission of Supplemental Project for inclusion in the Local Plan 2/27/2020

Previously Presented:

Needs Meeting 9/25/2019

Solutions Meeting 1/17/2020

Project Driver:

Customer Service

Specific Assumption Reference:

AEP Connection Requirements for the AEP Transmission System (AEP Assumptions Slide 7)

Problem Statement:

APCO Distribution has requested a new distribution station located in Kenna, West Virginia. Summer projected load 11 MVA. Winter projected load 18 MVA.

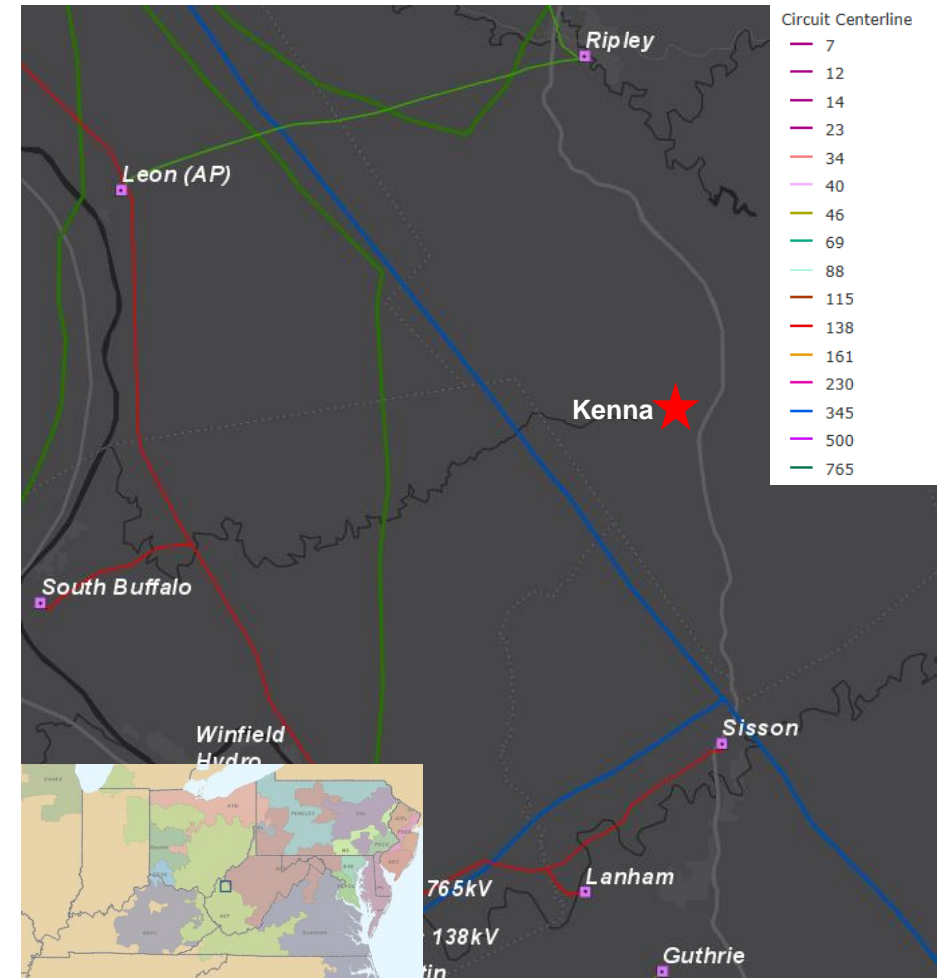

AEP Transmission Zone M-3 Process Kenna Station

Need Number: AEP-2019-AP034, AEP-2019-AP035

Process Stage: Submission of Supplemental Project for inclusion in the Local Plan 2/27/2020

Selected Solution:

Construct a new 138 kV line (~11.5 mi.) from Kenna to the existing Ripley 138 kV station. **(S2178.1) Estimated Trans. Cost: \$26.5M**

Construct a new 138 kV line (~10 mi.) from Kenna to the existing Sisson 138 kV station. **(S2178.2) Estimated Trans. Cost: \$25.5M**

Install three new 138 kV circuit breakers at Sisson and perform remote end relaying work at Amos Station. **(S2178.3) Estimated Trans. Cost: \$4.8M**

Install 138 kV bus and two new 138 kV circuit breakers at Kenna. **(S2178.4) Estimated Trans. Cost: \$3.8M**

Install one new 138 kV circuit breaker at Ripley. **(S2178.5) Estimated Trans. Cost: \$1.1M**

Total Estimated Transmission Cost: \$61.7M

Projected In-Service: 11/1/2022

Supplemental Project ID: S2178.1-.5

Project Status: Scoping

Model: 2024 RTEP

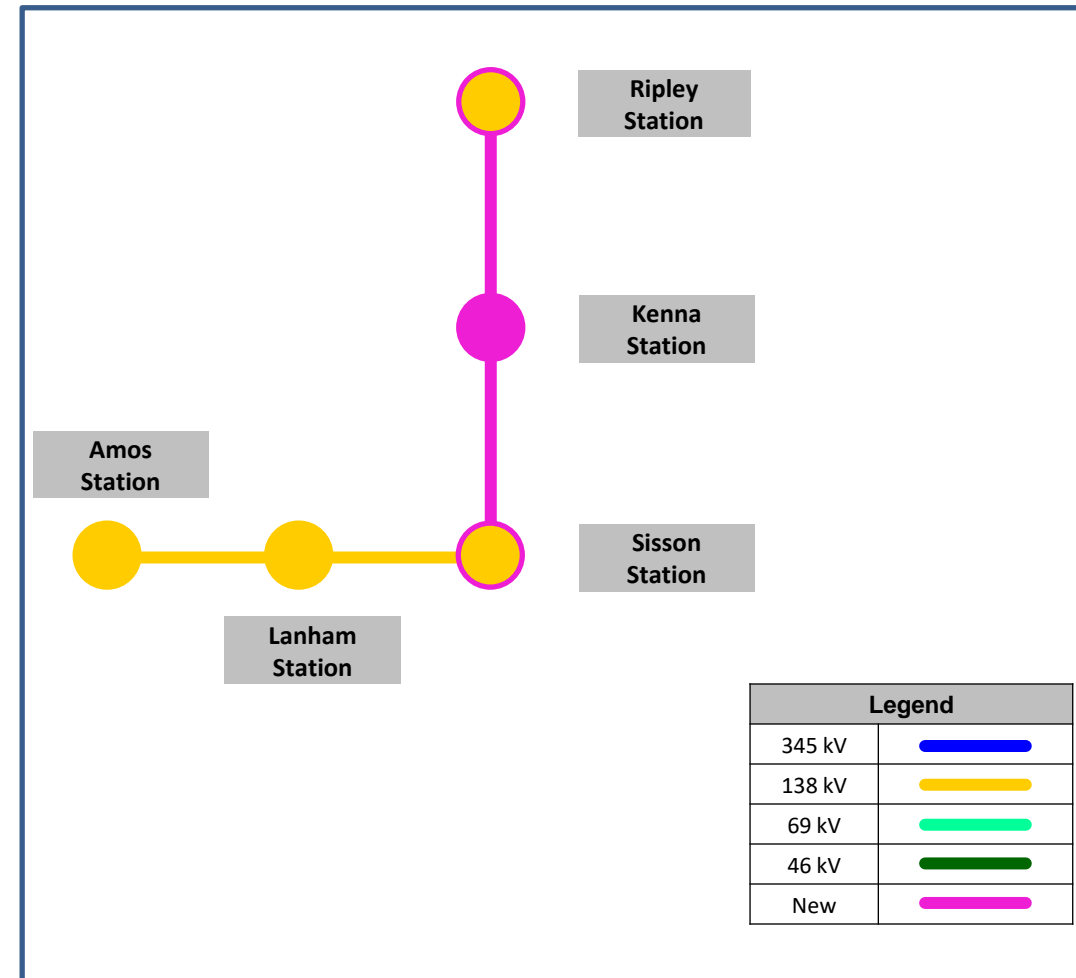

AEP Transmission Zone M-3 Process Findlay North Baltimore Improvements

Need Number: AEP-2018-OH007

Process Stage: Submission of Supplemental Project for inclusion in the Local Plan 04/10/2020

Previously Presented:

Needs Meeting 10/26/2018

Solutions Meeting 2/21/2020

Project Driver:

Equipment Material/Condition/Performance/Risk, Operational Flexibility and Efficiency

Specific Assumption Reference:

AEP Guidelines for Transmission Owner Identified Needs

Problem Statement:

The 138/34kV transformers and 34kV circuit breakers at New Liberty, North Baltimore, and North Findlay Stations have significant asset renewal needs. Between these three stations seventeen (17) 34.5kV circuit breakers/ circuit switchers have been identified as needing replacement, fifteen (15) of which are oil filled (vintage 1950's) and have seen a high number of fault operations. Short circuit capability is also a concern for many of these 34.5 kV breakers at New Liberty and North Findlay stations.

North Findlay Station:

- 34.5kV CBs F, G, H, J, K, L
- 34.5kV circuit switcher BB
- Transformers #1 and 2

New Liberty Station:

- 34.5kV CBs C, E, G, H, I, J
- Transformers #1 and 2

North Baltimore Station:

- 34.5kV CBs A, B, C, E

Morrical Switch

- 34.5kV CB A

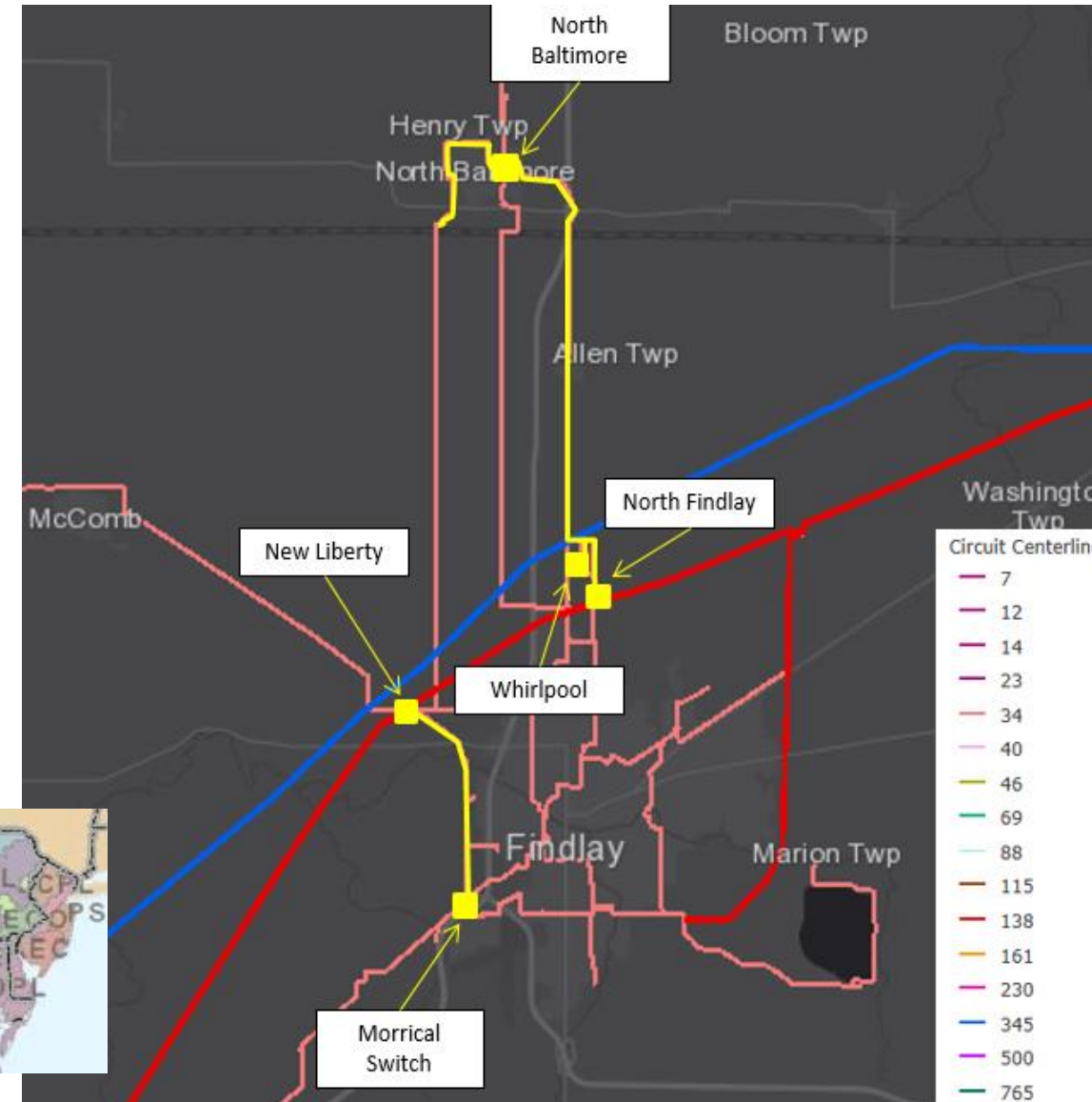

AEP Transmission Zone M-3 Process Findlay North Baltimore Improvements

Need Number: AEP-2018-OH007

Process Stage: Submission of Supplemental Project for inclusion in the Local Plan
04/10/2020

Selected Solution:

- Rebuild approximately 3.0 miles of New Liberty – North Baltimore 34kV line. **(S2199.1) Estimated Cost: \$9.3M**
- Rebuild 8.0 miles of North Findlay – North Baltimore #1 34kV line (advanced construction date due to imminent failure). **(S2199.2) Estimated Cost: \$25.3M**
- Rebuild 0.15 miles of Whirlpool Extension. **(S2199.3) Estimated Cost: \$0.8M**
- Build 1.0 mile of Oilers Switch Extension. **(S2199.4) Estimated Cost: \$2.2M**
- Rebuild 2.9 miles of New Liberty – Findlay Center 34kV line. **(S2199.5) Estimated Cost: \$10.4M**
- At North Findlay station, replace 34.5kV CBs F, G, H, J, K, L with 34.5kV 2000A 40kA breakers. Replace 34.5kV circuit switcher BB (40kA). Replace T1 and T2 with 90MVA 138/69/34kV transformers. **(S2199.6) Estimated Cost: \$12.1M**
- At New Liberty station, remove existing T1 and T2. Replace with one 90 MVA 138/69/34kV Transformer. Install High Side Circuit switcher for new Transformer. Expand station to build new 34.5 kV ring bus with (6) 2000A 40kA breakers. **(S2199.7) Estimated Cost: \$11.4M**
- At Oilers switch station, build new ring bus in the clear with (4) 2000A 40kA breakers to replace Morriscal switch. **(S2199.8) Estimated Cost: \$5.3M**
- At North Baltimore station, rebuild station with (4) 2000A 40kA breakers. **(S2199.9) Estimated Cost: \$4.9M**
- Install three way 1200A switch called “Touchstone” to replace Liberty Hi switch. **(S2199.10) Estimated Cost: \$0.7M**

Existing Configuration:

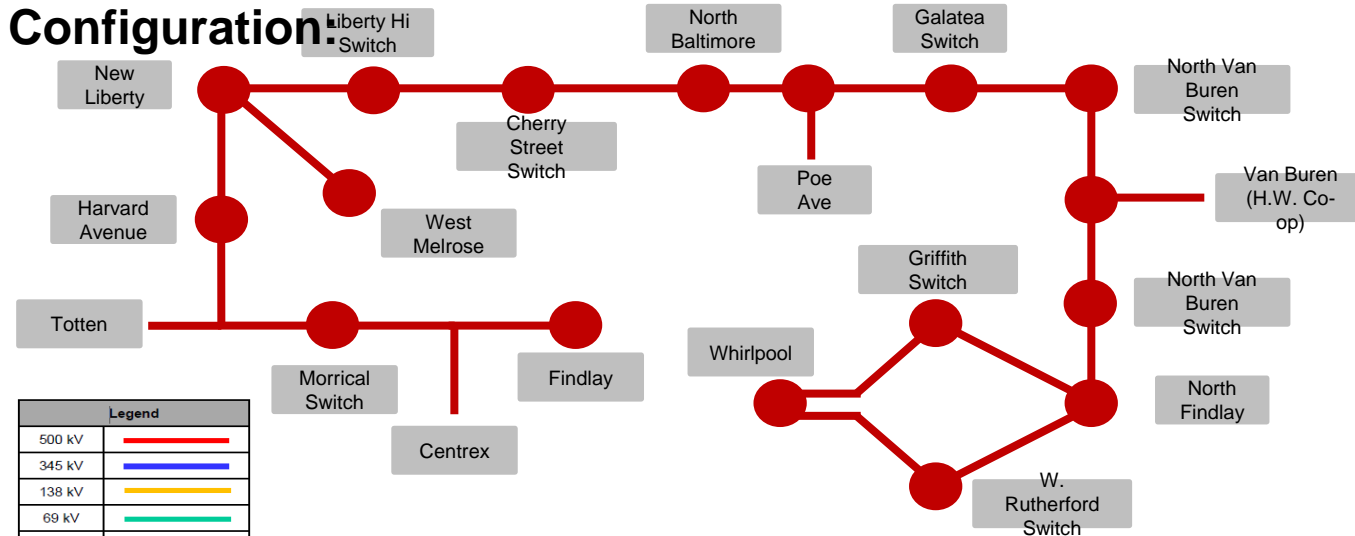

Legend	
500 kV	—
345 kV	—
138 kV	—
69 kV	—
34.5 kV	—
23 kV	—
New	—

Future Configuration:

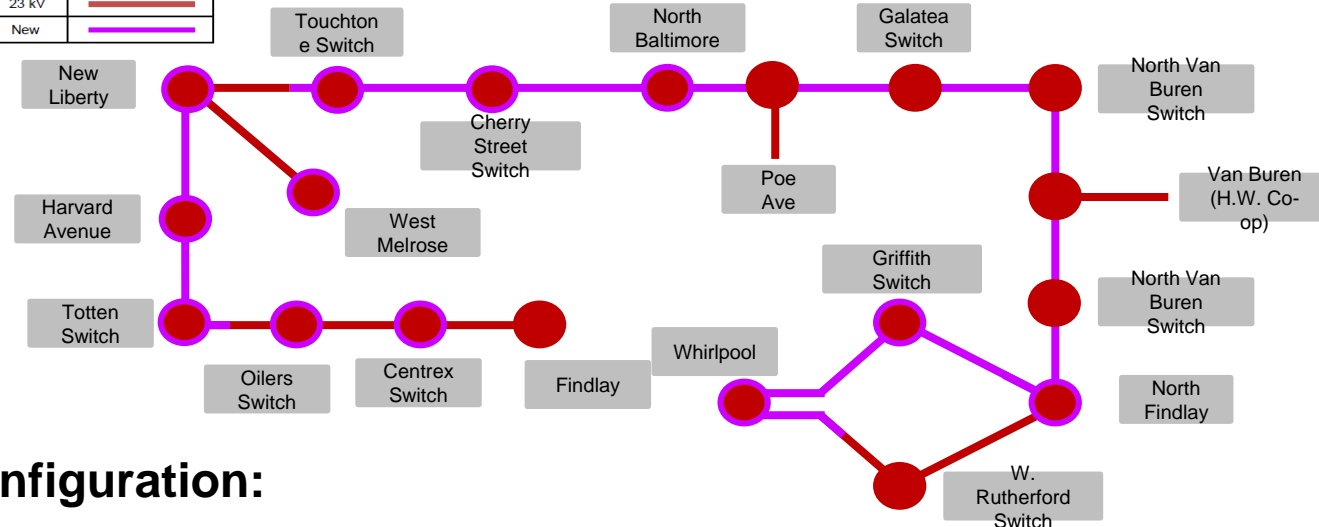

AEP Transmission Zone M-3 Process Findlay North Baltimore Improvements

Existing Configuration:

- Replace Cherry Street switch with a two way 1200A switch. (S2199.11) **Estimated Cost: \$0.6M**
- Replace West Melrose switch with 1200A switches. (S2199.12) **Estimated Cost: \$0.2M**
- Replace Harvard Avenue switch with a three way 1200A switch. (S2199.13) **Estimated Cost: \$0.6M**
- Install three way 1200A switch called “Totten” to eliminate the hard tap to the customer. (S2199.14) **Estimated Cost: \$0.6M**
- Install two way 1200A switch called “Centrex” to eliminate the hard tap to the customer. (S2199.15) **Estimated Cost: \$0.5M**
- Replace Griffith switch with a two way 1200A switch. (S2199.16) **Estimated Cost: \$0.6M**
- Replace Whirlpool MOABs with 1200A capability. (S2199.17) **Estimated Cost: \$0.4M**

Estimated Cost: \$85.9 M

Projected In-Service: 8/2022

Supplemental Project ID: S2199.1-.17

Project Status: Engineering

Model: N/A

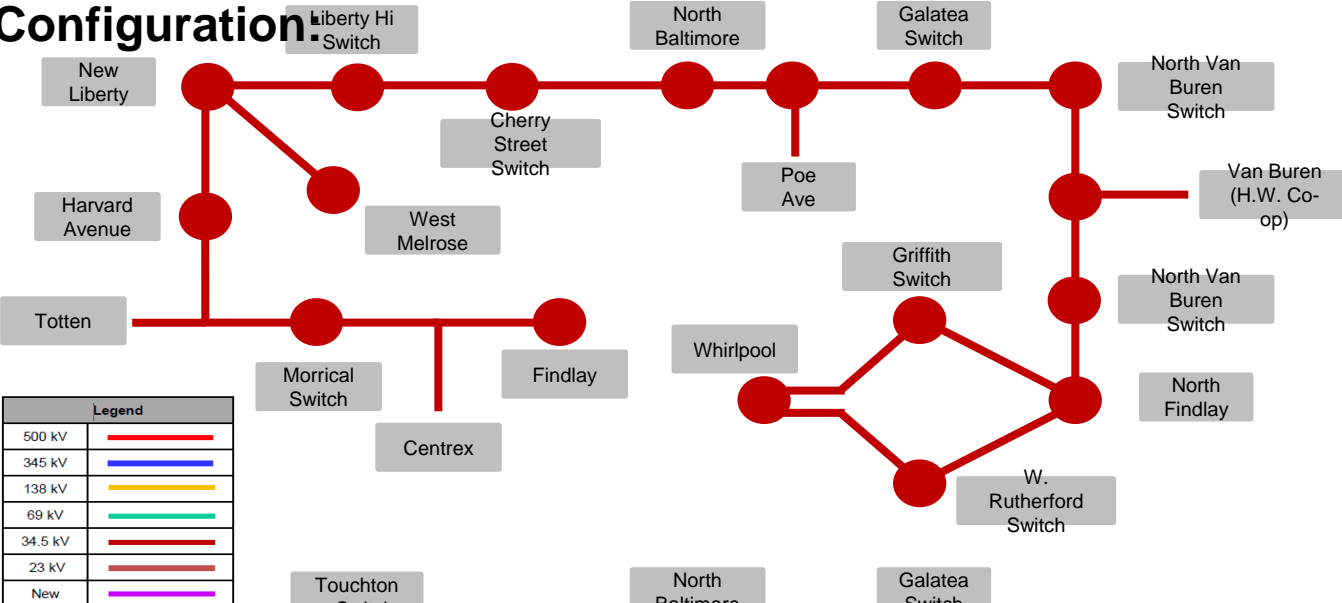

Future Configuration:

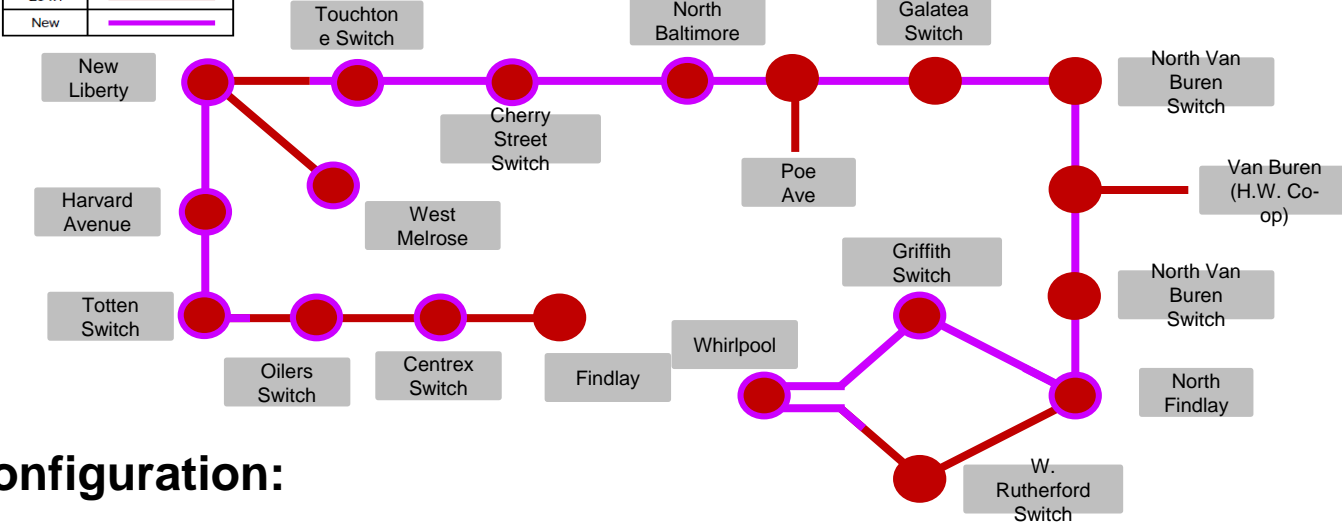

AEP Transmission Zone M-3 Process Lockbourne

Need Number: AEP-2019-OH012

Process Stage: Submission of Supplemental Project for inclusion in the Local Plan 04/10/2020

Previously Presented:

Needs Meeting 3/28/2019

Solutions Meeting 2/21/2020

Project Driver:

Customer Service

Specific Assumption Reference:

AEP Guidelines for Transmission Owner Identified Needs (AEP Assumptions slide 7)

Problem Statement:

- South Central Power is rebuilding Lockbourne 138kV Station due to asset renewal conditions. Lockbourne is currently radially served via AEP's Harrison Station, this line is partially owned by AEP and South Central Power with the point of ownership change being Circleville. The current loading on this radial line is 65MW with plans for increased load. Total CMI 2.7M over 3 year period. (2015-2018).
- Radial service restricts the ability to perform routine maintenance and can cause extended outages to customers. The maintenance of radial transmission lines often requires cost-prohibitive temporary facilities or other labor-intensive measures.



AEP Transmission Zone M-3 Process Lockbourne

Need Number: AEP-2019-OH012

Process Stage: Submission of Supplemental Project for inclusion in the Local Plan 04/10/2020

Selected Solution:

- Build new 0.3 mile double circuit 138kV extension from the Harrison – Lemaster 138kV Circuit to the new Lockbourne 138kV station Fiber will also be installed on the line. **(S2198.1) Cost: \$2.0M**
- Remove the existing 138 kV radial line from AEP Harrison to SCP Harrison station. **(S2198.2) Cost: \$0.3M**
- Build three short lines to interconnect to SCP’s Lockbourne station to serve their three transformers. **(S2198.3) Cost: \$0.1M**
- Build a new 138kV five (5) breaker switch station (Lockbourne) with 3000A 40kA breakers and a capacitor bank (28.8 MVAR) to provide service to three SCP deliveries at the site. **(S2198.4) Cost: \$11.1M**
- Remove existing breaker 3E from the ring bus at Harrison. **(S2198.5) Cost: \$0.3M**

Estimated Cost: \$13.8 M

Projected In-Service: 9/23/2021

Supplemental Project ID: S2198.1-5

Project Status: Scoping

Model: 2024 RTEP

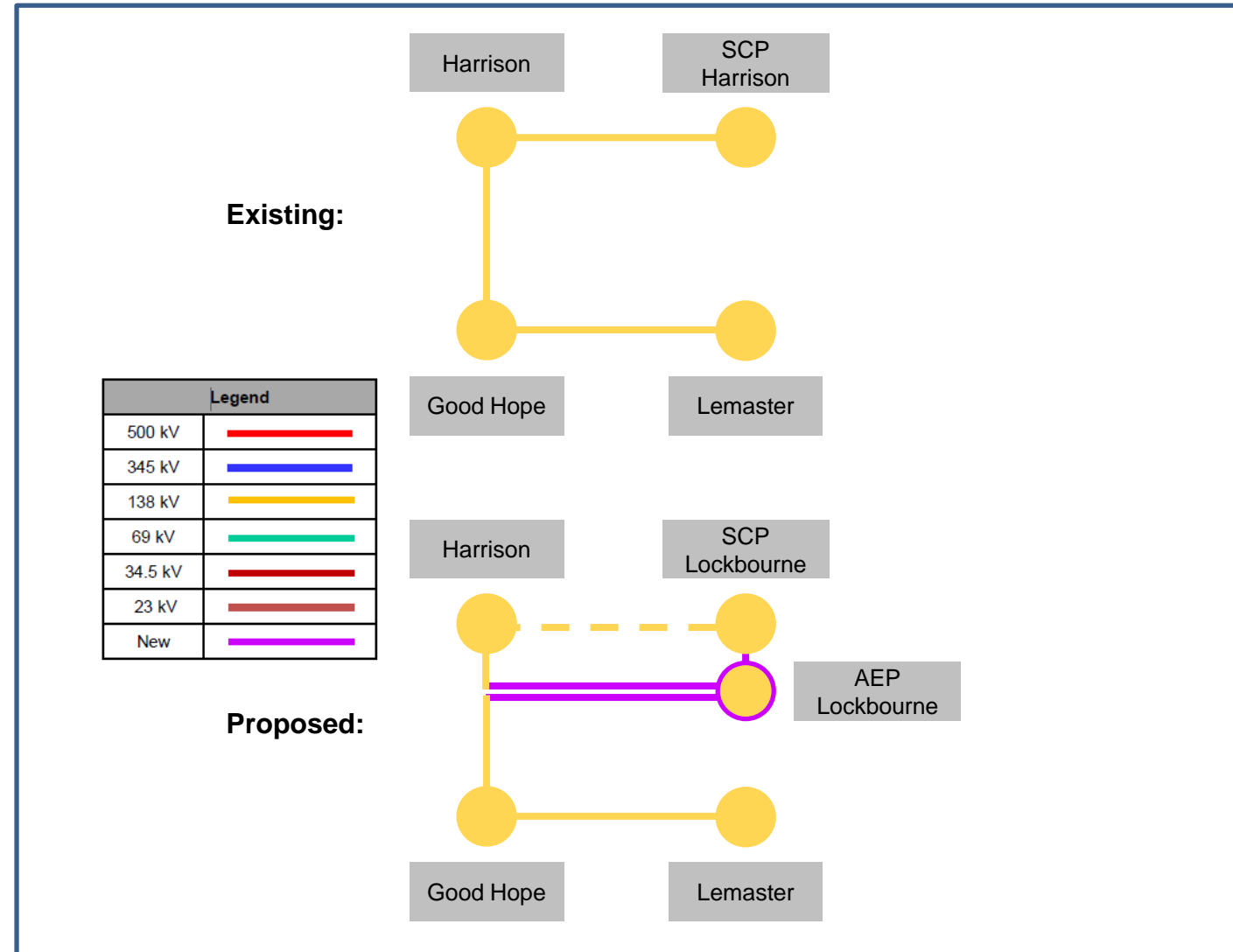

AEP Transmission Zone M-3 Process Stuart – Seaman

Need Number: AEP-2019-OH014

Process Stage: Submission of Supplemental Project for inclusion in the Local Plan 04/10/2020

Previously Presented:

Needs Meeting 04/23/2019

Solutions Meeting 02/21/2020

Project Driver:

Equipment Material/Condition/ Performance/Risk

Specific Assumption Reference:

AEP Guidelines for Transmission Owner Identified Needs

Problem Statement:

- The existing 28.5 mile, 69 kV line section between Stuart (DP&L/Duke) and Seaman(AEP) was constructed in 1974 using wood pole structures with 636 ACSR conductor. There are 260 open conditions distributed across the 170 structures on this line.
- The Stuart-Seaman 69 kV circuit has experienced over 2.2 million customer minutes of interruption in the past three years: 753,716 for AEP and 1,517,618 for Adams Coop.

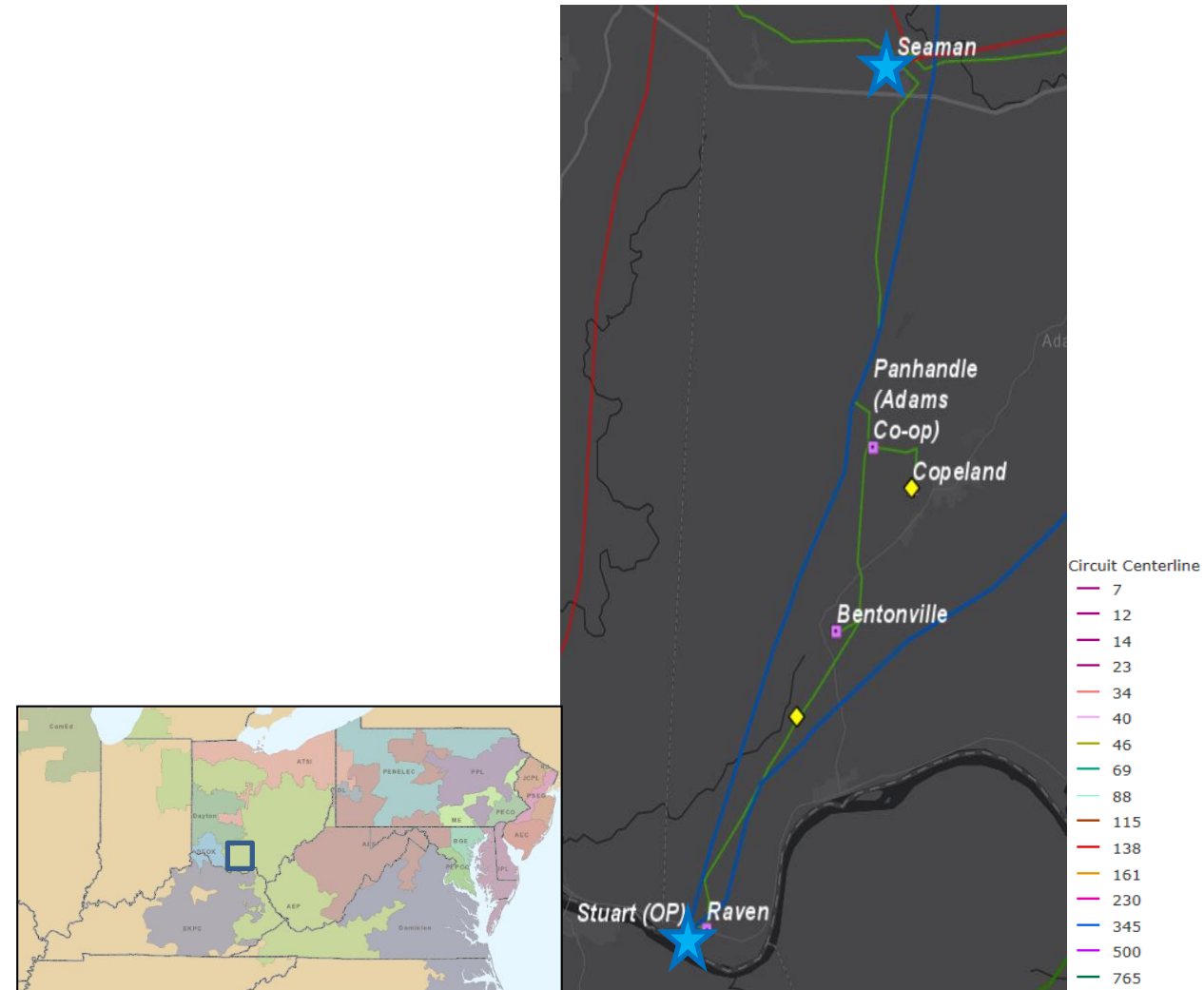

AEP Transmission Zone M-3 Process Stuart - Seaman

Need Number: AEP-2019-OH014

Process Stage: Submission of Supplemental Project for inclusion in the Local Plan 04/10/2020

Selected Solution:

Rebuild 22.0 miles of the existing 28.5 mile Stuart-Seaman 69kV circuit with 795 ACSR. Retire approximately 3 miles of the line between West Union and structure 86. 32 of the line's 170 structure were replaced since 2012 and will not be replaced as part of the rebuild (**S2184.1**)

Estimated Cost: \$48.5M

Construct approximately 2.5 miles of new line from structure 86 on the Stuart – Seaman 69 kV line to Copeland station utilizing 795 ACSR. (**S2184.2**) **Estimated Cost: \$5.0M**

Rebuild the 2.0 mile West Union – Copeland 69 kV line utilizing 795 ACSR. The line is part of the Stuart – Seaman 69 kV circuit and is currently radial fed from West Union switch. (**S2184.3**)

Estimated Cost: \$4.0M

Establish a four breaker 69 kV ring (3000A, 40kA) at the existing Copeland station to serve the Adams Co-op and AEP Ohio customers currently served from a hard tap at the end of the radial. (**S2184.4**) **Estimated Cost: \$5.0M**

Retire existing West Union Switch. (**S2184.5**) **Estimated Cost: \$0.1M**

Install new 2000A 3-way phase over phase switch at Panhandle. (**S2184.6**) **Estimated Cost: \$0.7M**

Replace the existing Poplar Flats switch with a new 2000A 3-way phase over phase switch. (**S2184.7**) **Estimated Cost: \$0.7M**

Remote end upgrade and equipment relocation work will be required at Seaman station to accommodate the new line at the station. (**S2184.8**) **Estimated Cost: \$1.0M**

Estimated Cost: \$65.0M

Projected In-Service: 12/01/2024

Supplemental Project ID: S2184.1-.8

Project Status: Scoping

Model: N/A

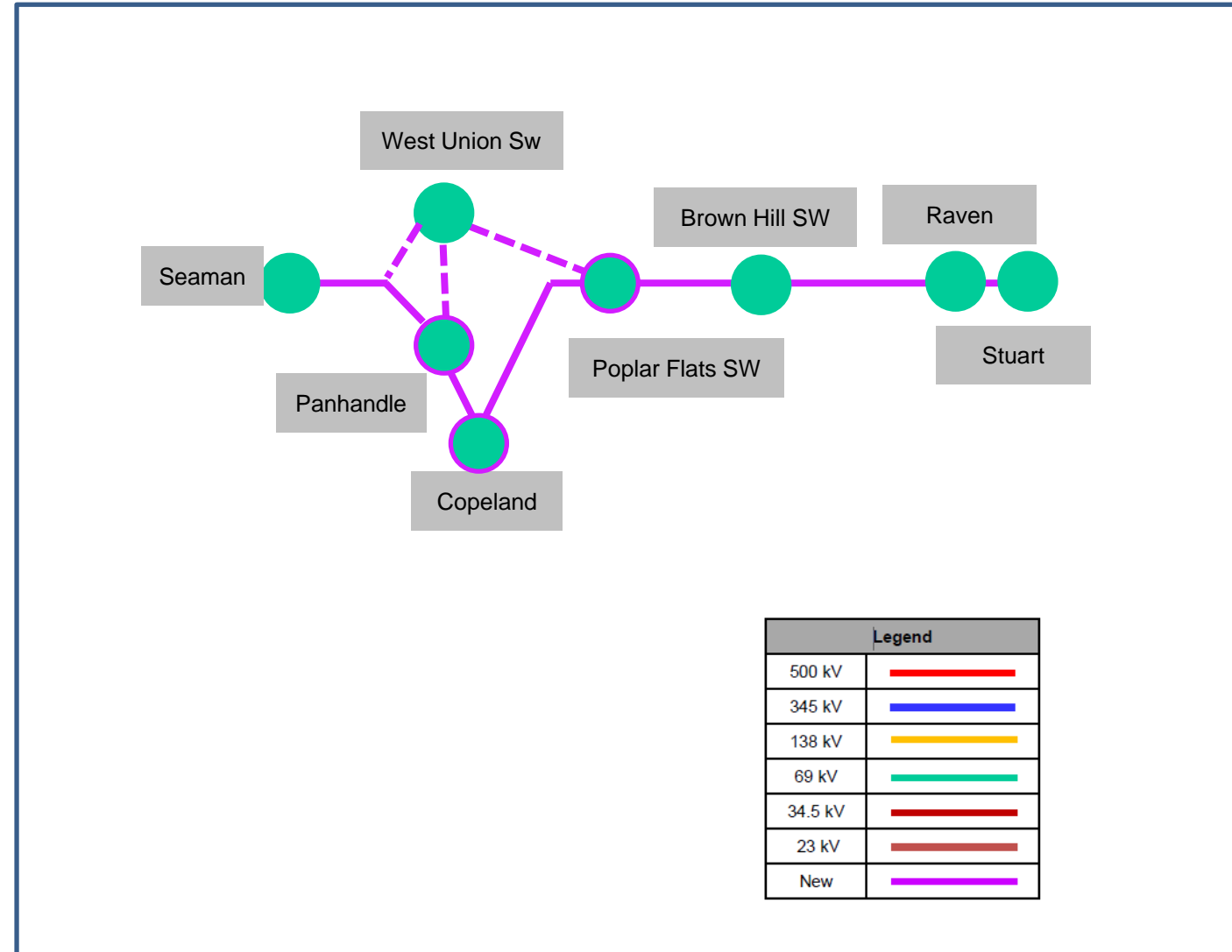

AEP Transmission Zone M-3 Process Sunnyside – Torrey 138kV Rebuild

Need Number: AEP-2019-OH027

Process Stage: Submission of Supplemental Project for inclusion in the Local Plan 04/10/2020

Previously Presented:

Needs Meeting 05/20/2019

Solutions Meeting 2/21/2020

Project Driver:

Equipment/Material/Condition/Performance/Risk

Specific Assumption Reference:

AEP Guidelines for Transmission Owner Identified Needs (AEP Assumptions Slide 8)

Problem Statement:

- The majority (94%) of the Sunnyside-Torrey 138 kV line (4.3 miles) is comprised of steel lattice towers built in 1918, with the remaining 6%, dating back to 1954.
- The conductor is original vintage (1918), consisting of 6-wired 200 MCM copper & 250 MCM copper.
- Note that the 0.3-mile customer tap was built in 2007 and is in adequate condition.

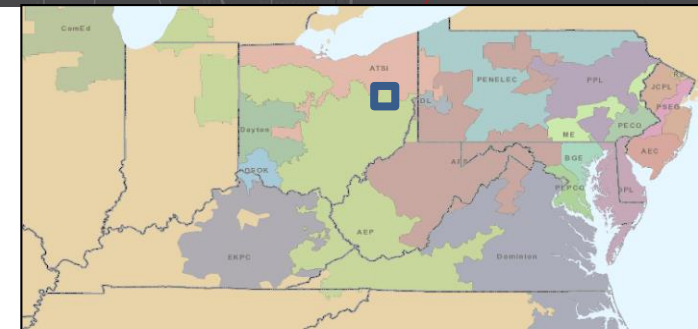
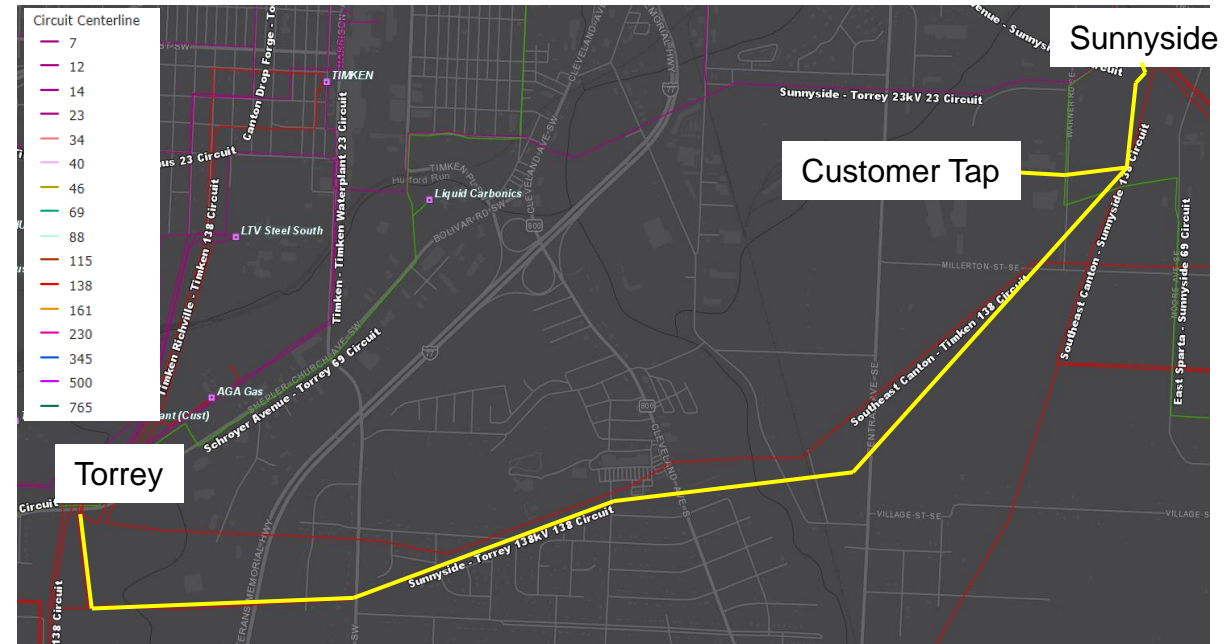

AEP Transmission Zone M-3 Process Sunnyside – Torrey 138kV Rebuild

Need Number: AEP-2019-OH027

Process Stage: Submission of Supplemental Project for inclusion in the Local Plan 04/10/2020

Selected Solution:

Rebuild the 4-mile Sunnyside-Torrey 138kV circuit. Supplement the existing right-of-way as needed, to resolve encroachments and other constraints. **(S2185)**

Ancillary Benefits: Improved reliability for the industrial customer served from the circuit.

Estimated Cost: \$12.7 M

Projected In-Service: 8/1/2022

Supplemental Project ID: S2185

Project Status: Scoping

Model: N/A

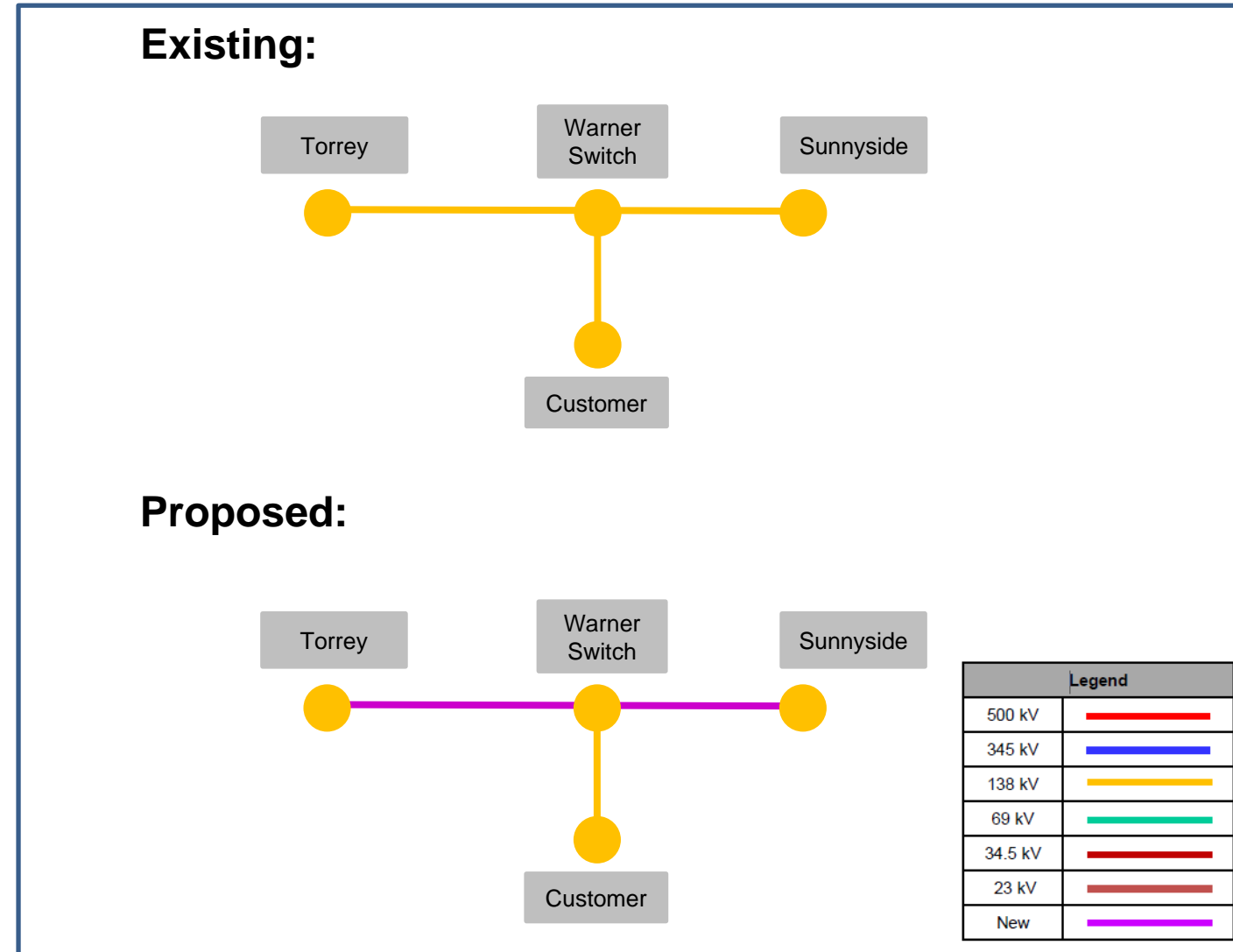

AEP Transmission Zone M-3 Process North Newark – Sharp Road 138kV Rebuild

Need Number: AEP-2019-OH043

Process Stage: Submission of Supplemental Project for inclusion in the Local Plan 04/10/2020

Previously Presented:

Needs Meeting 7/24/2020

Solutions Meeting 2/21/2020

Project Driver:

Equipment Material/Condition/Performance/Risk

Specific Assumption Reference:

AEP Guidelines for Transmission Owner Identified Needs (AEP Assumptions Slide 8)

Problem Statement:

North Newark – Sharp Road 138kV (vintage 1951)

- Length: 19.38 Miles
- Original Construction Type: Wood Pole
- Original Conductor Type: 477 KCM Hawk
- Number of open conditions: 68
 - Open conditions include: Burnt insulators, insect damage, pole rot, woodpecker damage

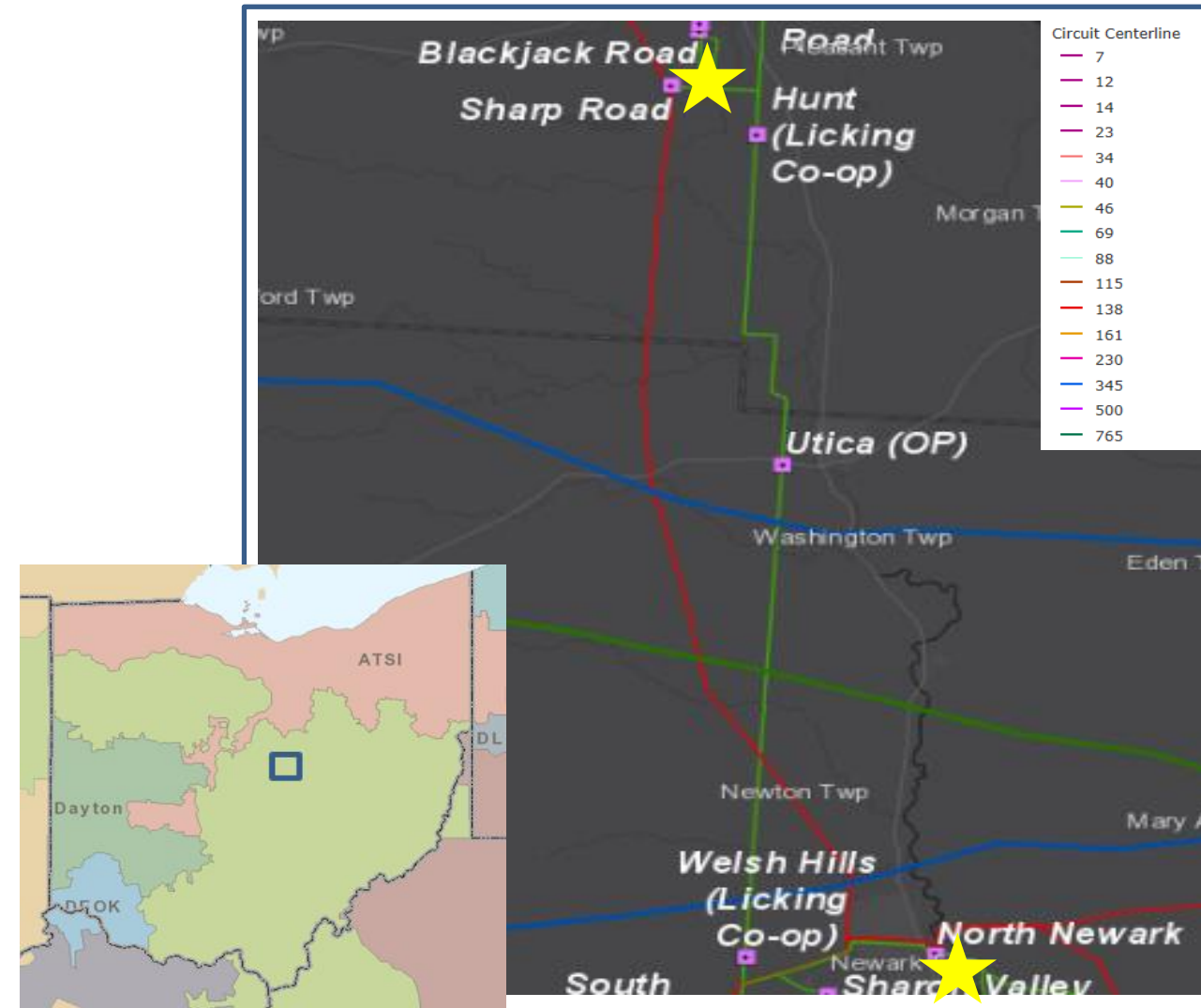

AEP Transmission Zone M-3 Process North Newark – Sharp Road 138kV Rebuild

Need Number: AEP-2019-OH043

Process Stage: Submission of Supplemental Project for inclusion in the Local Plan 04/10/2020

Selected Solution:

- Rebuild the existing 138kV line with 19.4 miles of new 1033 ACSR. (**S2186**)

Estimated Cost: \$42.2 M

Projected In-Service: 7/1/2023

Supplemental Project ID: S2186

Project Status: Scoping

Model: N/A

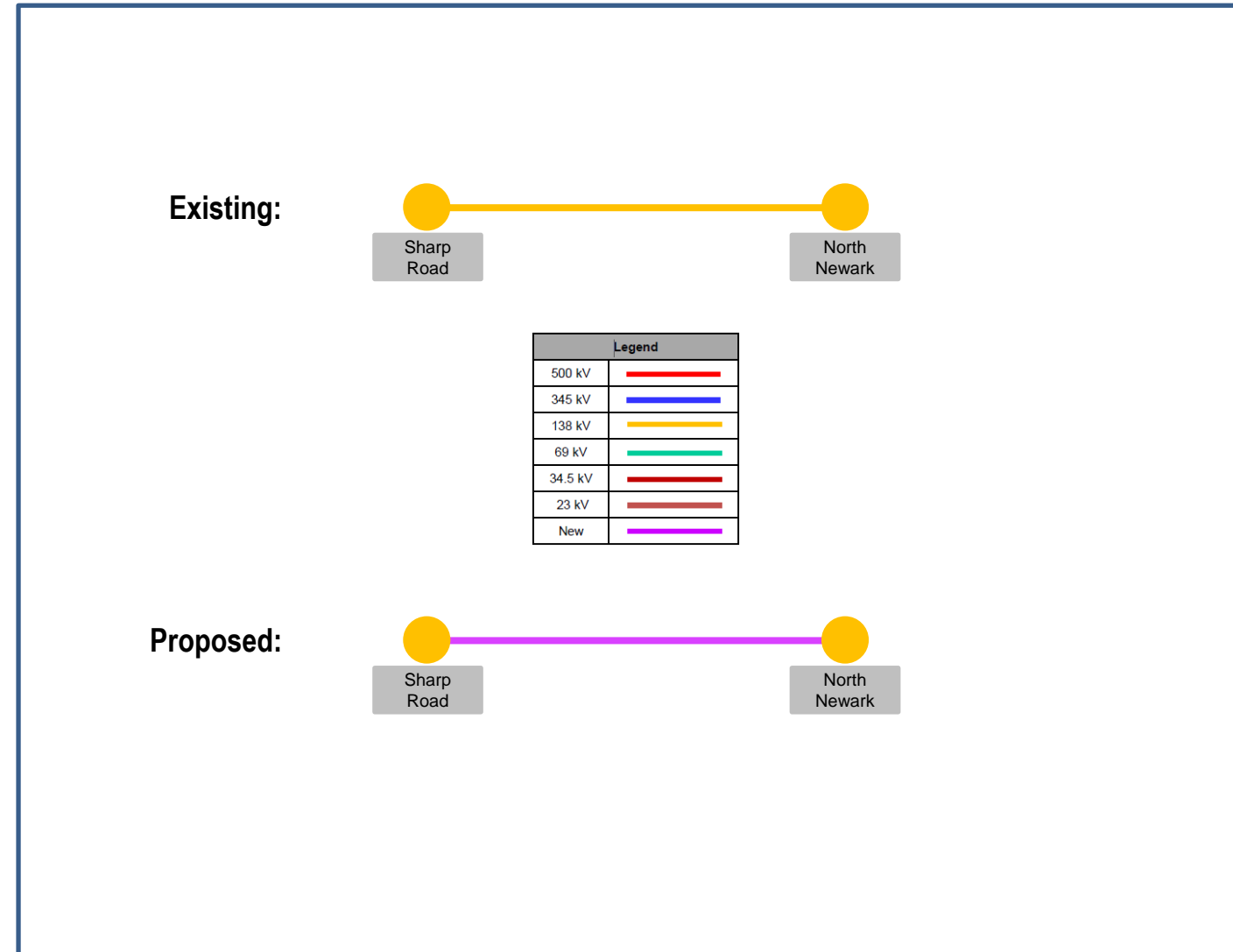

AEP Transmission Zone M-3 Process Culbertson 138kV Greenfield Station

Need Number: AEP-2019-OH051

Process Stage: Submission of Supplemental Project for inclusion in the Local Plan 04/10/2020

Previously Presented:

Needs Meeting 9/25/2019

Solutions Meeting 2/21/2020

Project Driver:

Customer Service

Specific Assumption Reference:

AEP Connection Requirements for the AEP Transmission System
(AEP Assumptions Slide 7)

Problem Statement:

Customer Service:

- Peak load: 30MW
- A customer has requested new service on the Ohio Central – Philo #1 138 kV circuit.

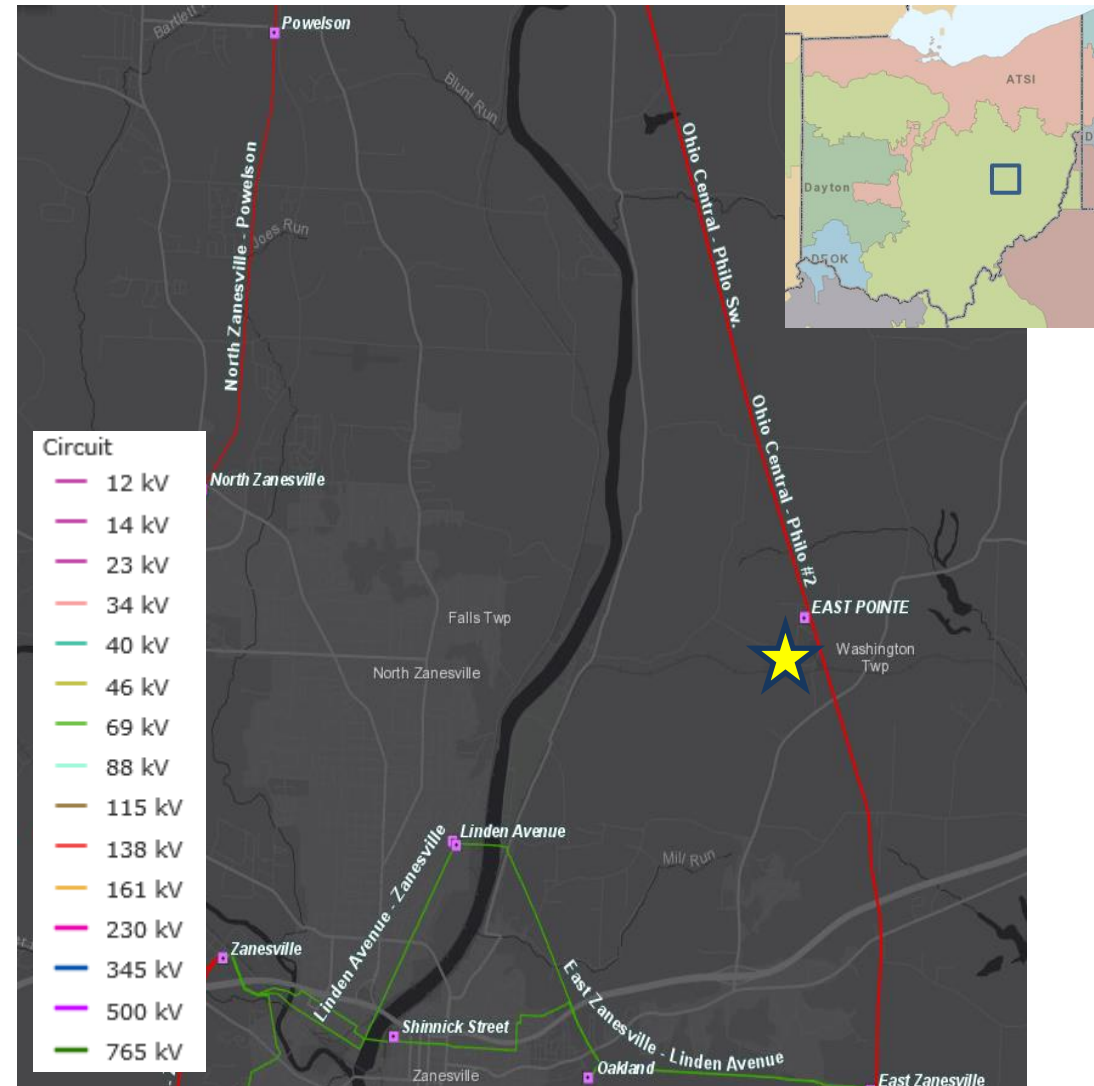

AEP Transmission Zone M-3 Process Culbertson 138kV Greenfield Station

Need Number: AEP-2019-OH051

Process Stage: Submission of Supplemental Project for inclusion in the Local Plan 04/10/2020

Selected Solution:

- Install approximately 0.5 Miles of 138kV double circuit line to tie the greenfield Culbertson station to the Ohio Central – Philo #1 138kV circuit. **(S2187.1) Estimated Cost: \$1.9M**
- Culbertson 138kV: Install 4 greenfield 138kV 2000A 40kA CBs in a ring bus configuration to serve the new customer station. **(S2187.2) Estimated Cost: \$8.0M**

Estimated Cost: \$9.9 M

Projected In-Service: 9/01/2020

Supplemental Project ID: S2187.1-.2

Project Status: Engineering

Model: 2024 RTEP

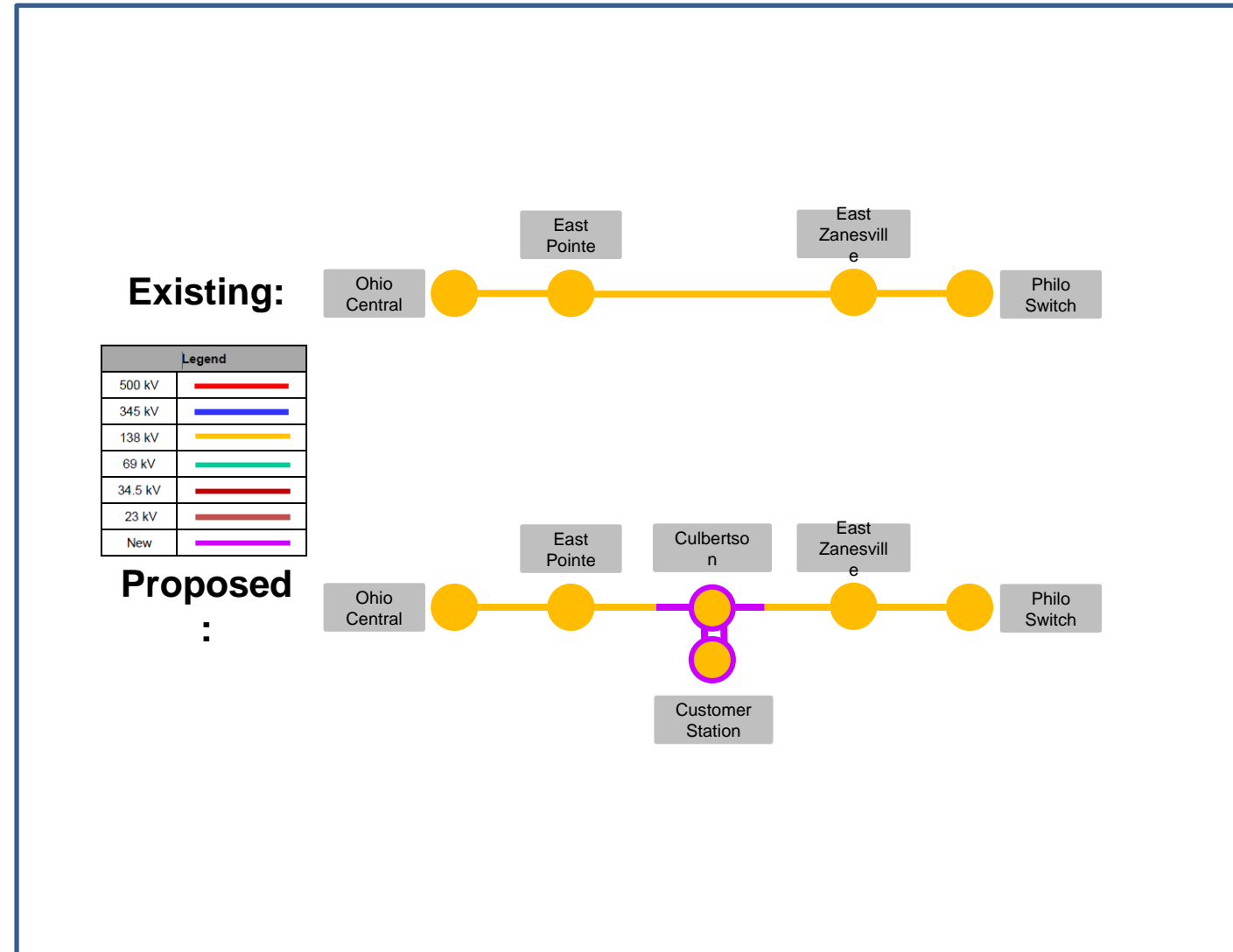

AEP Transmission Zone M-3 Process Garrett Area Improvements

Need Number: AEP-2019-AP017

Process Stage: Submission of Supplemental Project for inclusion in the Local Plan
04/10/2020

Previously Presented:

Needs Meeting 6/17/2019
Solutions Meeting 2/21/2020

Project Driver:

Equipment Material/ Condition/Performance/Risk, Operational Flexibility and Efficiency

Specific Assumption Reference:

AEP Guidelines for Transmission Owner Identified Needs (AEP Assumptions Slide 8)

Problem Statement:

Beaver Creek – McKinney #1 46 kV Circuit

- From 2016-2018, the approximately 24.6 mile Beaver Creek – McKinney #1 46 kV circuit has experienced 22 outages.
- The circuit is comprised of 152 structures, the majority of which are wood structures dating back to 1929 (22/152, 14%) and 1949 (61/152, 40%).
- There are 142 open conditions along the 24.6 mile long line. These include damaged pole and cross-arms, conductor/shield wires, and guy anchor/knee/vee braces.

Hays Branch Station

- Hays Branch serves a ~30 MW gas compressing operation that is currently radially fed from a ~8.25 mile line out of Morgan Fork station.

Saltlick Station

- Saltlick serves an EKPC co-op that is currently radially fed off the Beaver Creek – McKinney 46 kV circuit.

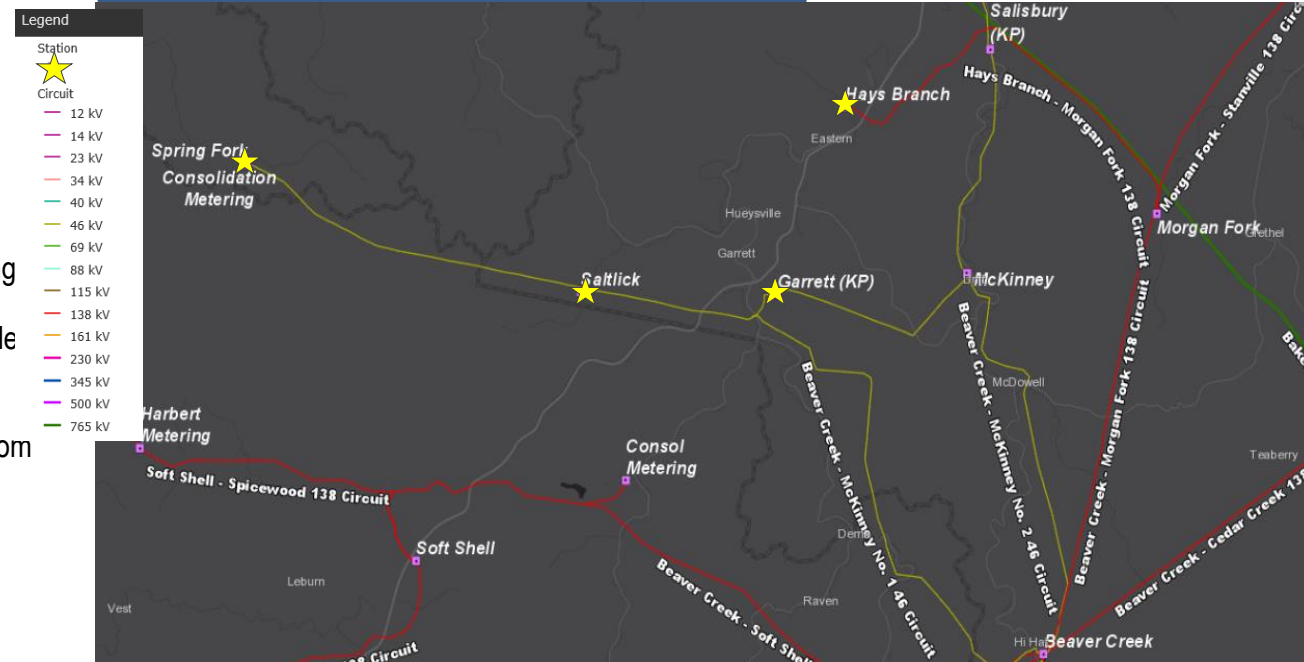

AEP Transmission Zone M-3 Process Garrett Area Improvements

Continued from previous slide...

Spring Fork

- Spring Fork station serves KPCo distribution customers and is currently radially fed off the Beaver Creek – McKinney 46 kV circuit.

Consolidation Metering

- Consolidation Metering station serves a mining operation and is currently radially fed off the Beaver Creek – McKinney 46 kV circuit.

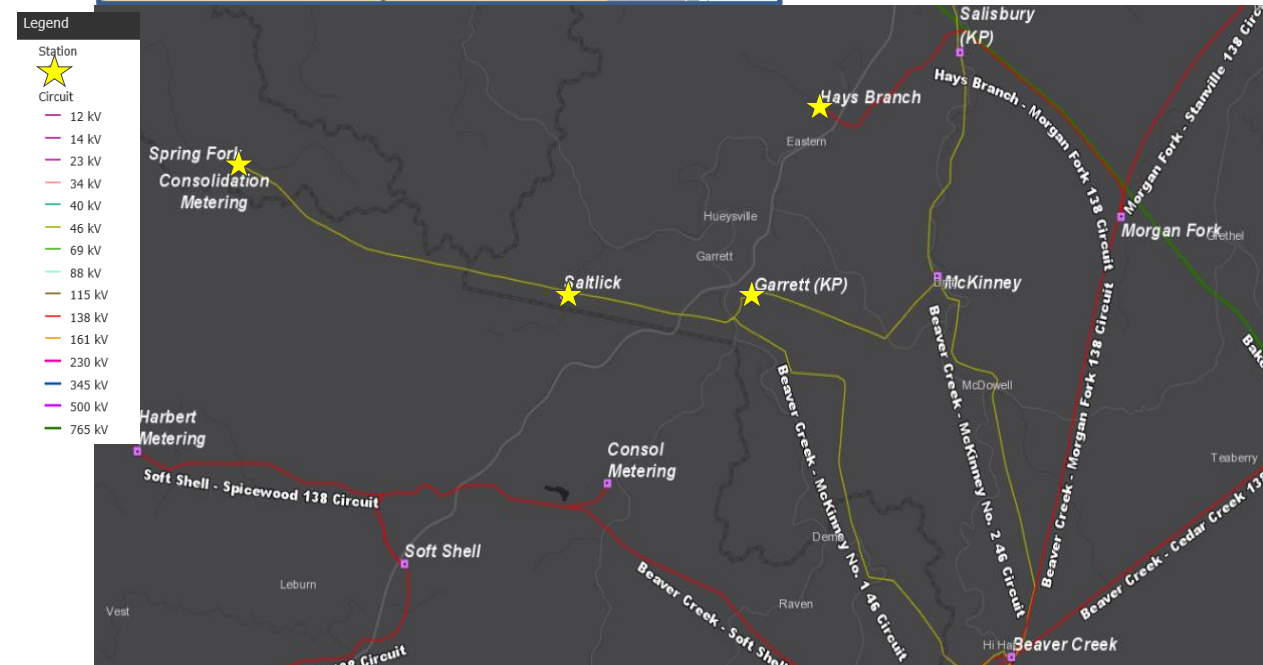
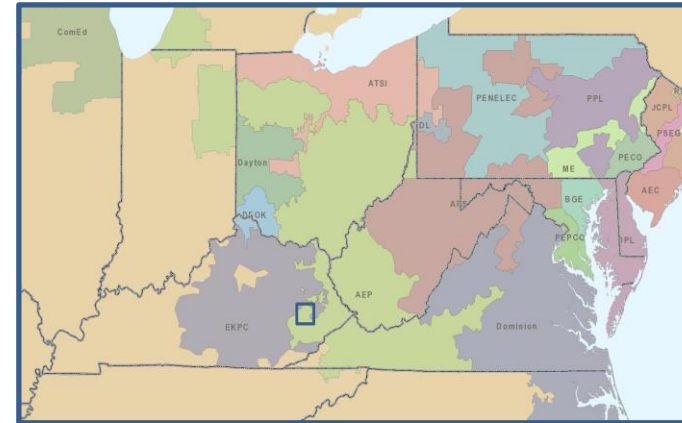

AEP Transmission Zone M-3 Process Garrett Area Improvements

Need Number: AEP-2019-AP017

Process Stage: Submission of Supplemental Project for inclusion in the Local Plan 04/10/2020

Selected Solution:

Construct ~~~9.3~~**10.3** miles of single circuit 138kV from Soft Shell to Garrett picking up Salt Lick Co-op via Snag Fork along the way. **Complete associated remote end relaying.**
(S2188.1) Estimated Cost: **\$35.3M**

Construct ~~~3~~**5** miles of single circuit 138kV from the Eastern station to Garrett station. A short extension will be required from the new station to the existing Hays Branch metering point. Construct short extension to existing Morgan Fork – Hays Branch 138 kV circuit from Eastern station
(S2188.2) Estimated Cost: **\$11.5M**

Double circuit cut into existing Hays Branch - Morgan Fork line to tie into new **Eastern station. Hays Branch S-S PoP switch. Installation of a new heavy double circuit dead-end tap structure on the existing Hays Branch – Morgan Fork 138kV Line (Due to unequal loading on the transmission line).**
(S2188.3) Estimated Cost: **\$1.3M**

Construct ~~~0.25~~**1.4** mi of double circuit 138kV line ~~between Hays Branch S-S – Eastern and the tap point on the Morgan Fork-Hays Branch line. The proposed line will establish a direct feed to Hays Branch from Eastern and establishing a through path line between Eastern and Morgan Fork. Installation of 3 double circuit suspension structures one of which is a custom pole structure.~~
(S2188.4) Estimated Cost: **\$1.6M**

New ~~PoP switch structure relaying~~ at Hays Branch to accommodate new line from Eastern station
(S2188.5) Estimated Cost: **\$0.5M**

Expand the Garrett station, Install ~~a 138kV three breaker ring bus (If space becomes a constraint, we should look at installing~~ a straight bus arrangement with two 138 kV breakers and a circuit switcher on the high side of the transformer), 138/12kV 30 MVA transformer
(S2188.6) Estimated Cost: ~~\$5.8M~~ **\$0.0M**

Establish a new 138 kV substation Eastern south of the existing Hays Branch station. Install ~~two~~**three** 138kV breakers (3000A 40kA) at the new Eastern station ~~on exits toward Morgan Fork and Garrett station in a ring bus arrangement.~~
(S2188.7) Estimated Cost: **\$6 M**

Establish Snag Fork S.S. Install a 3 way phase over phase motorized (automated) switching structure near Saltlick to serve the EKPC co-op.
(S2188.8) Estimated Cost: **\$1.1 M**

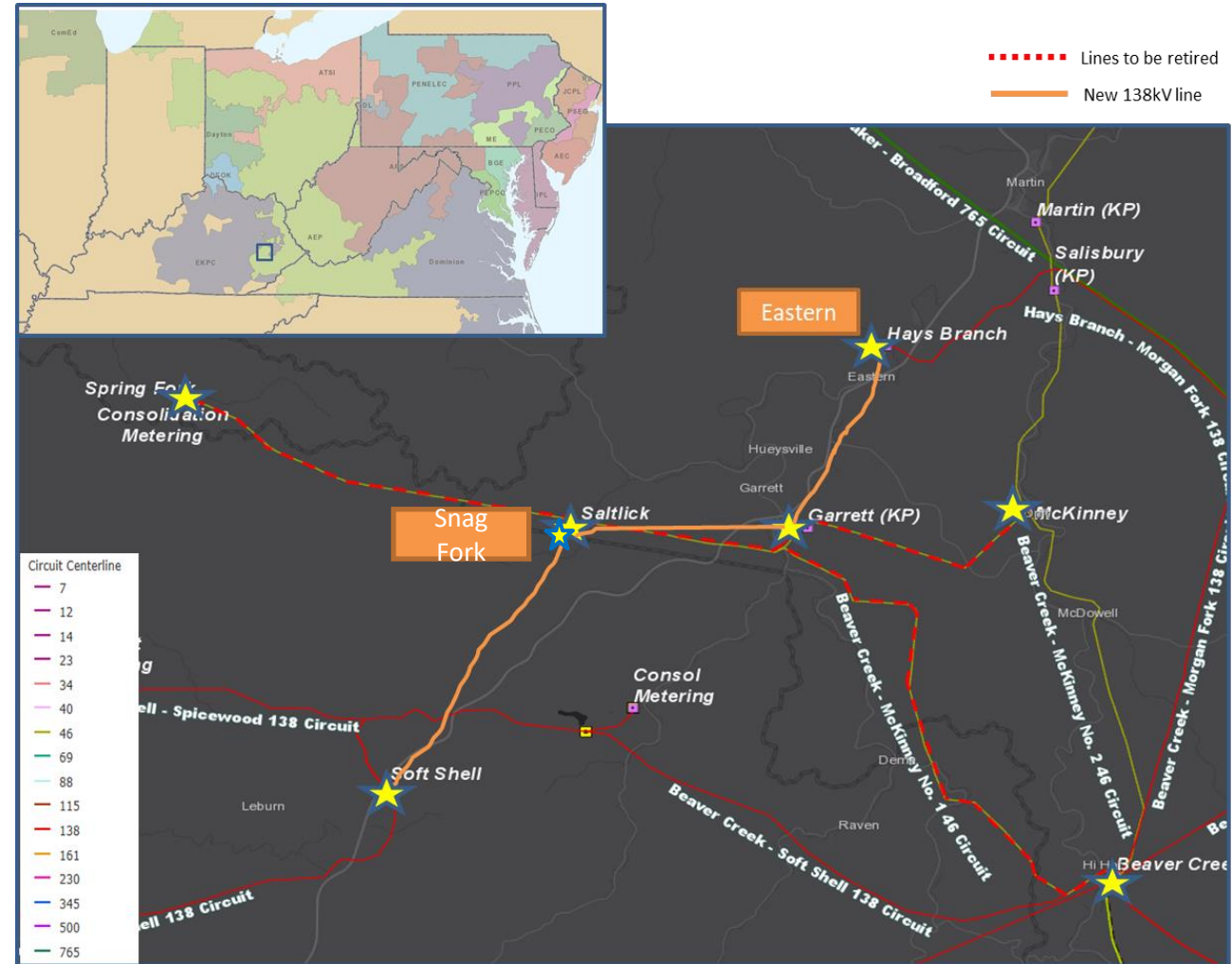

AEP Transmission Zone M-3 Process Garrett Area Improvements

Proposed Solution (Cont.):

Move the existing 69kV rated CB G to the Beaver Creek – McKinney #2 circuit exit at McKinney substation.

(S2188.9) Estimated Cost: **\$0.0 M**

Install a 138kV breaker (3000A 40kA) with an exit towards Garrett station (via Snag Fork) at Softshell substation.

(S2188.10) Estimated Cost: **~~\$0.8 M~~-\$0.0M**

Retire the ~25 miles of the 46kV Beaver Creek – McKinney #1 46 KV circuit. Retire Spring Fork Tap.

(S2188.11) Estimated Cost: **\$17.3 M**

Ancillary Benefits: Removal of obsolete ~25 mi of 46kV network.

Estimated Cost: **~~\$81.2M~~-\$74.6M**

Projected In-Service: **10/31/2023-11/15/2024**

Supplemental Project ID: **S2188.1-.11**

Project Status: Scoping

Model: N/A

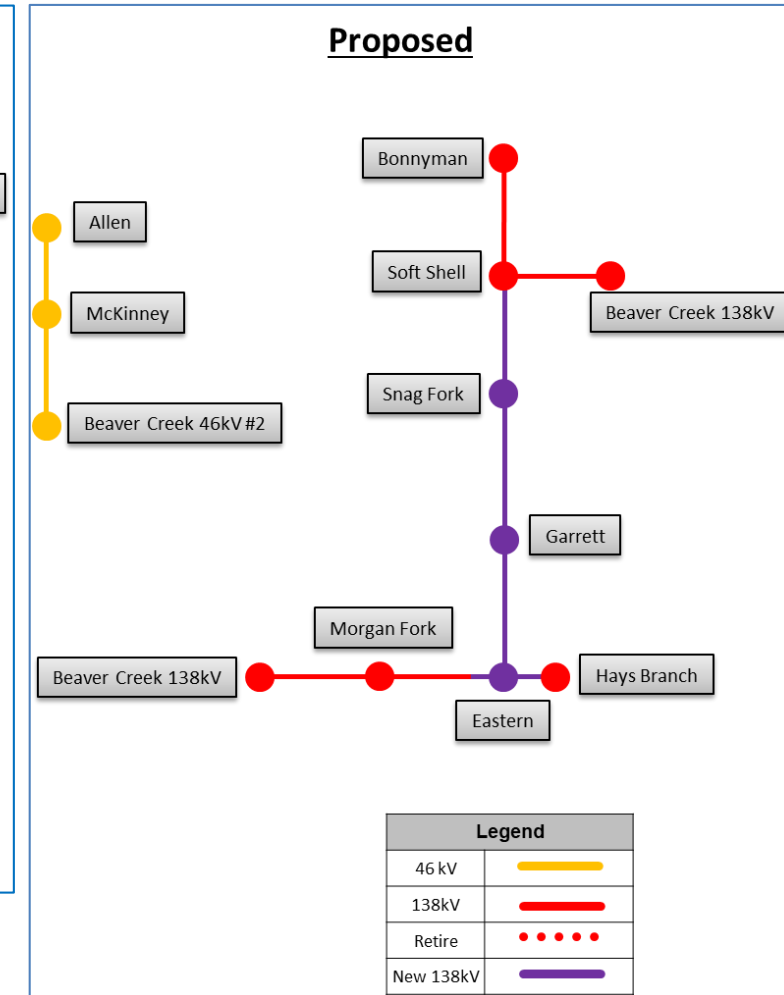
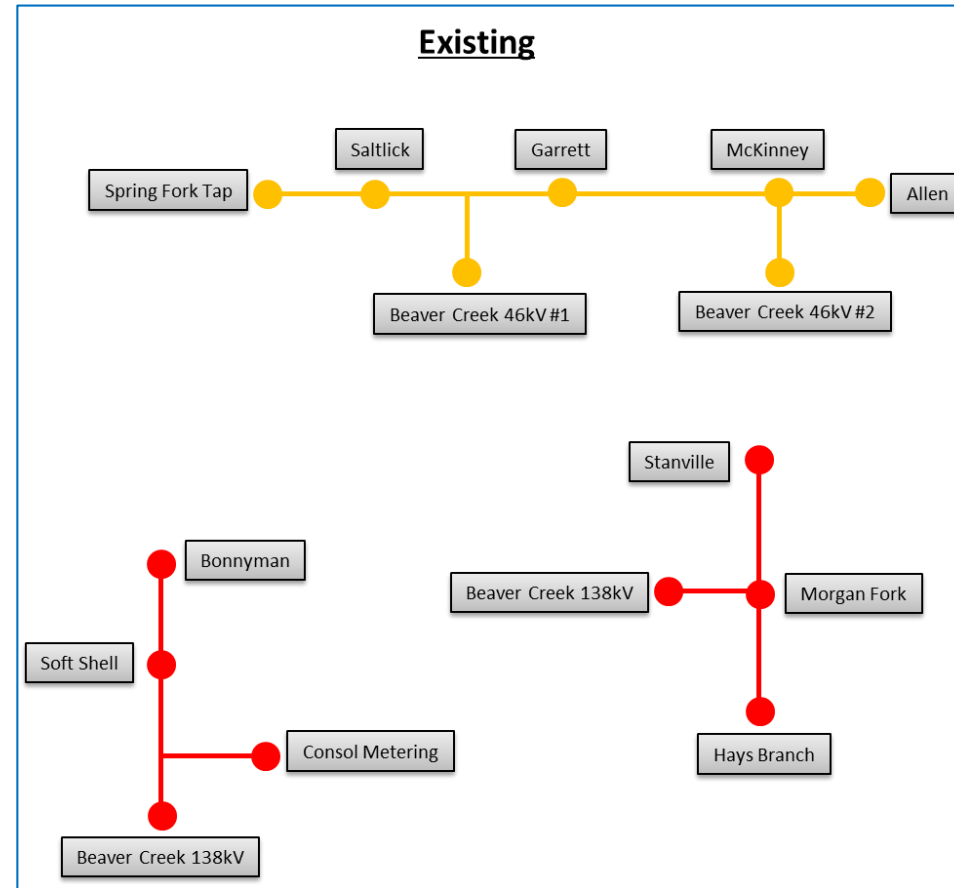

AEP Transmission Zone M-3 Process Baileysville – Hales Branch

Need Number: AEP-2019-AP024

Process Stage: Submission of Supplemental Project for inclusion in the Local Plan 04/10/2020

Previously Presented:

Needs Meeting 7/24/2019

Solutions Meeting 2/21/2020

Project Driver:

Equipment Condition/Performance/Risk

Specific Assumption Reference:

AEP Guidelines for Transmission Owner Identified Needs (AEP Assumptions Slide 8)

Problem Statement:

Baileysville – Hales Branch 138 kV (~27.8 miles)

- Majority of the circuit is constructed with 1970s wood structures.
- Between 2015-2018 the circuit experienced 24 momentary outages.
 - All momentary outages are attributed to lightening, insufficient shielding and aging towers as the structures, conductor, hardware, and insulators on the line are displaying issues associated with their age
- The circuit currently has 54 open conditions
 - Open conditions include: Rotten Tops, Woodpecker damage, Split Poles, Corroded Crossarms, Rotten Shells, Broken Ground Lead Wires, and Buildings Encroachment in Right Of Way
- Structures loading does not meet current NESC standards.

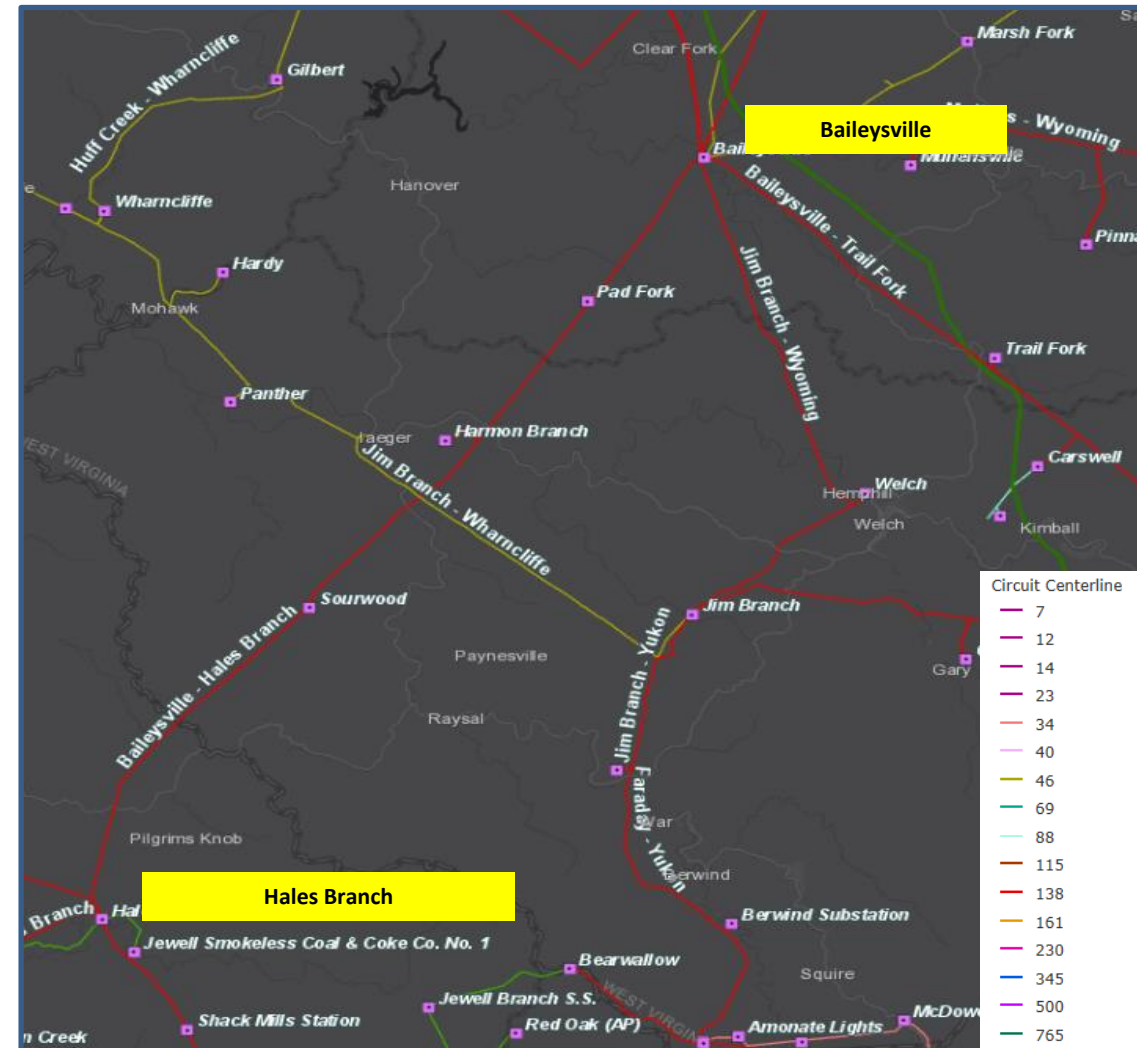

AEP Transmission Zone M-3 Process Baileysville – Hales Branch

Need Number: AEP-2019-AP024

Process Stage: Submission of Supplemental Project for inclusion in the Local Plan 04/10/2020

Selected Solution:

Rebuild ~27.8 miles of the existing Baileysville – Hales Branch 138kV circuit. (**S2189**)

Estimated Cost: \$98.5 M

Projected In-Service: 8/1/2026

Supplemental Project ID: S2189

Project Status: Scoping

Model: N/A

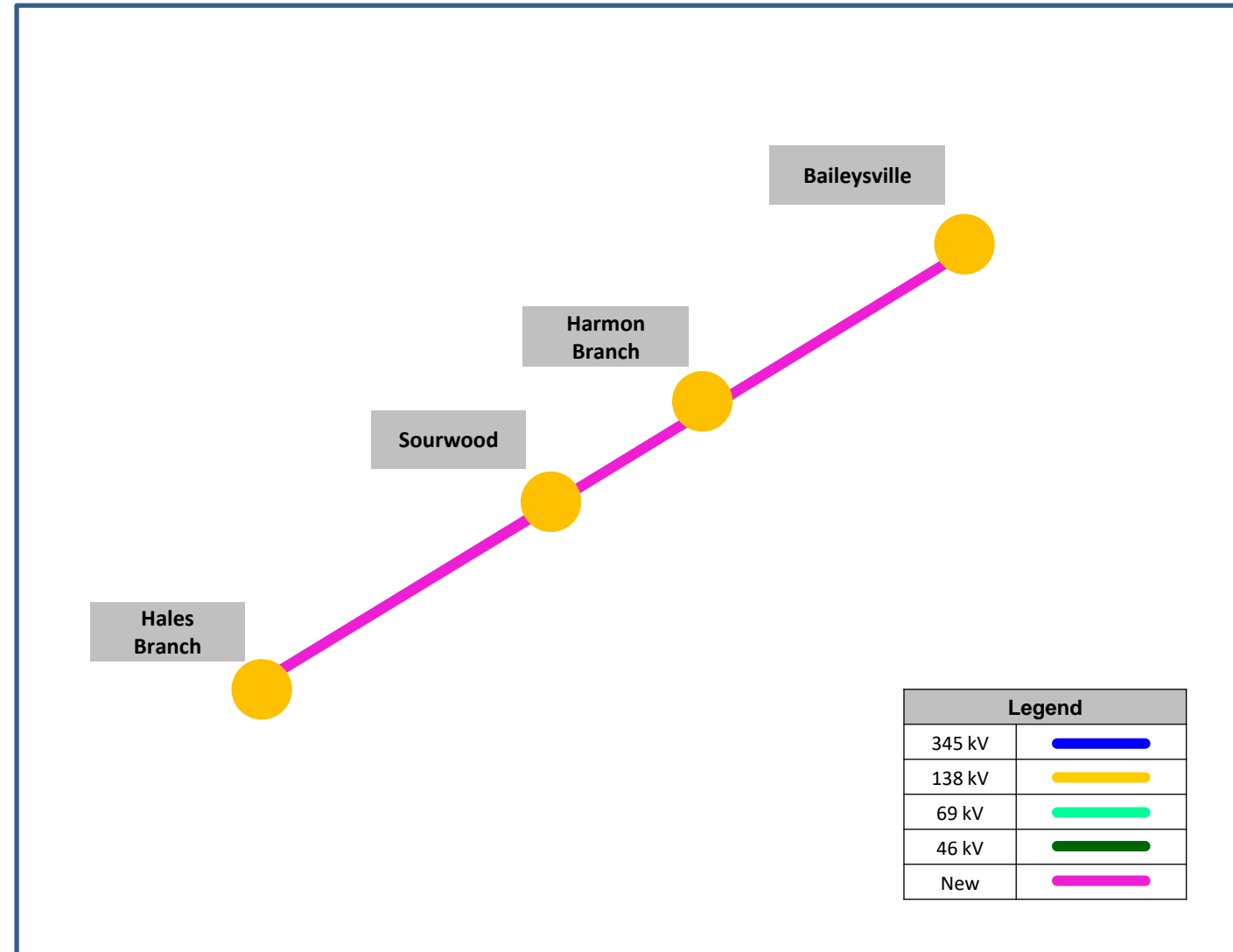

AEP Transmission Zone M-3 Process

Fieldale – Dan River Rebuild

Need Number: AEP-2019-AP043

Process Stage: Submission of Supplemental Project for inclusion in the Local Plan
04/10/2020

Previously Presented:

Needs Meeting 11/22/2019

Solutions Meeting 2/21/2020

Project Driver:

Equipment Material/Condition/Performance/Risk

Specific Assumption Reference:

AEP Guidelines for Transmission Owner Identified Needs (AEP Assumptions Slide 8)

Problem Statement:

- **Fieldale-Ridgeway 138 kV Circuit (10.3 mi.)**
 - 1949 wood H-Frame construction
 - 58 Type A open conditions on 35 unique structures (51% of all structures on circuit)
 - From 2015-2018, a total of 4 permanent outages resulting in 241,094 customer minutes of interruption
- **Ridgeway-Dan River 138 kV Circuit (4.5 mi.)**
 - 1949 wood H-Frame construction
 - 40 Type A open conditions on 23 unique structures (68% of all structures on circuit (owned by AEP))
 - From 2015-2018, a total of 3 permanent outages occurred

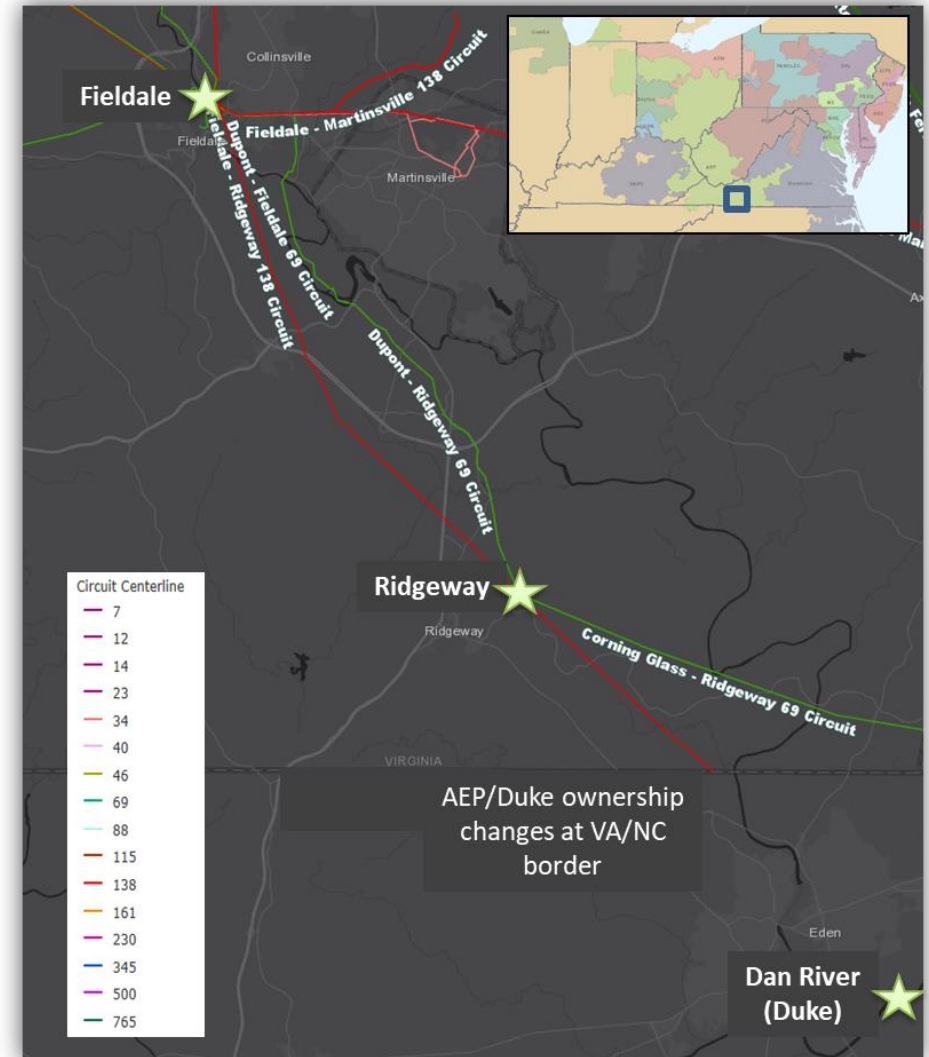

AEP Transmission Zone M-3 Process

Fieldale – Dan River Rebuild

Need Number: AEP-2019-AP043

Process Stage: Submission of Supplemental Project for inclusion in the Local Plan 04/10/2020

Selected Solution:

Rebuild approximately 15 miles of the AEP-owned portion of the 138 kV line between Fieldale and Dan River stations (AEP/Duke ownership changes at the VA/NC border). (**\$2190**)

Estimated Cost: \$32.2 M

Projected In-Service: 10/31/2022

Supplemental Project ID: S2190

Project Status: Scoping

Model: N/A

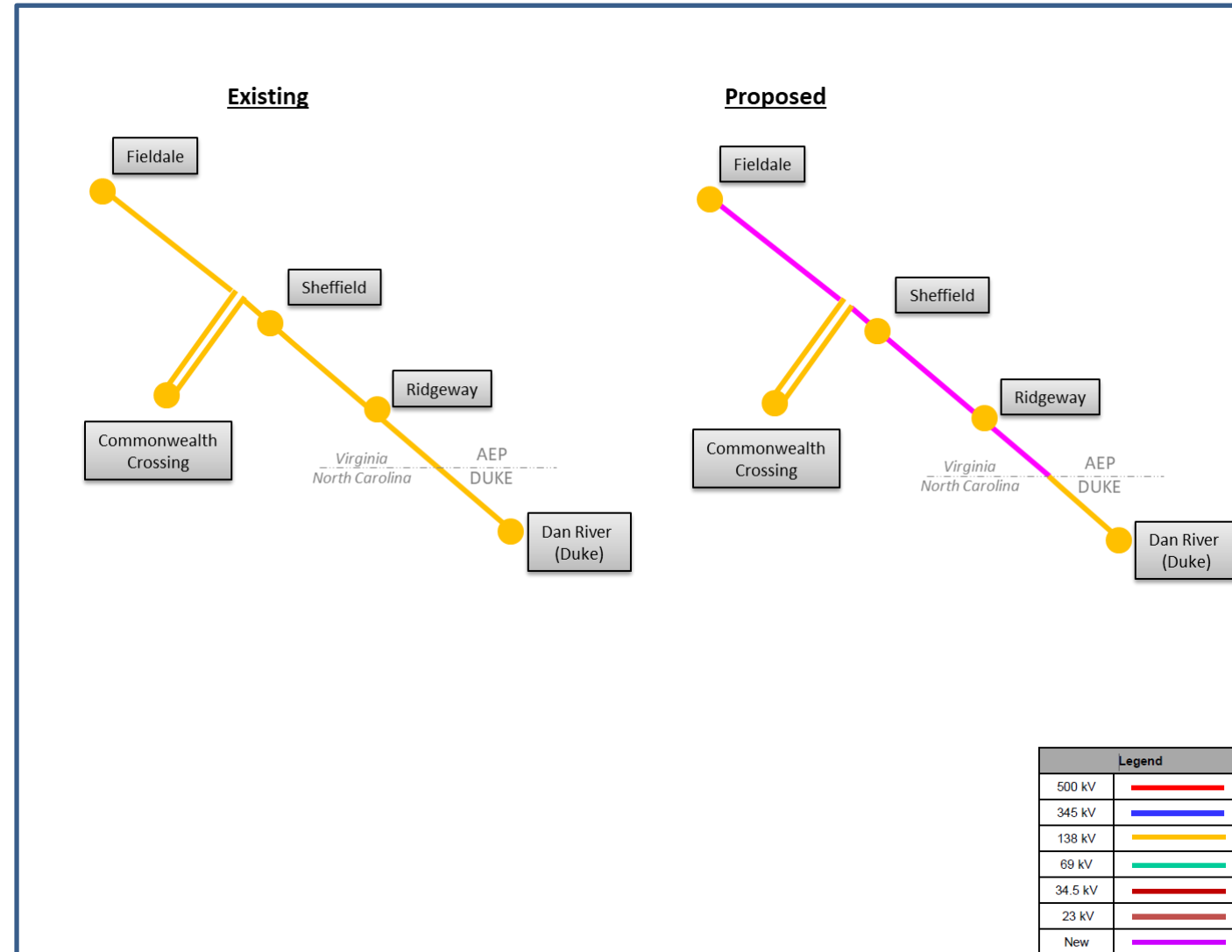

AEP Transmission Zone M-3 Process Commonwealth Crossing

Need Number: AEP-2019-AP045

Process Stage: Submission of Supplemental Project for inclusion in the Local Plan 04/10/2020

Previously Presented:

Needs Meeting 11/22/2019

Solutions Meeting 2/21/2020

Project Driver:

Customer Service

Specific Assumption Reference:

AEP Connection Requirements for the AEP Transmission System (AEP Assumptions Slide 7)

Problem Statement:

- Henry County VA (Customer) has requested that AEP construct a new 138 kV loop fed transmission line and a new 138-34.5kV (30 MVA) substation in its Commonwealth Crossing Business Centre (CCBC) to initially serve Press Glass (5 MVA). The CCBC is located roughly 5 miles from the Sheffield-Ridgeway 138kV line in Ridgeway VA.

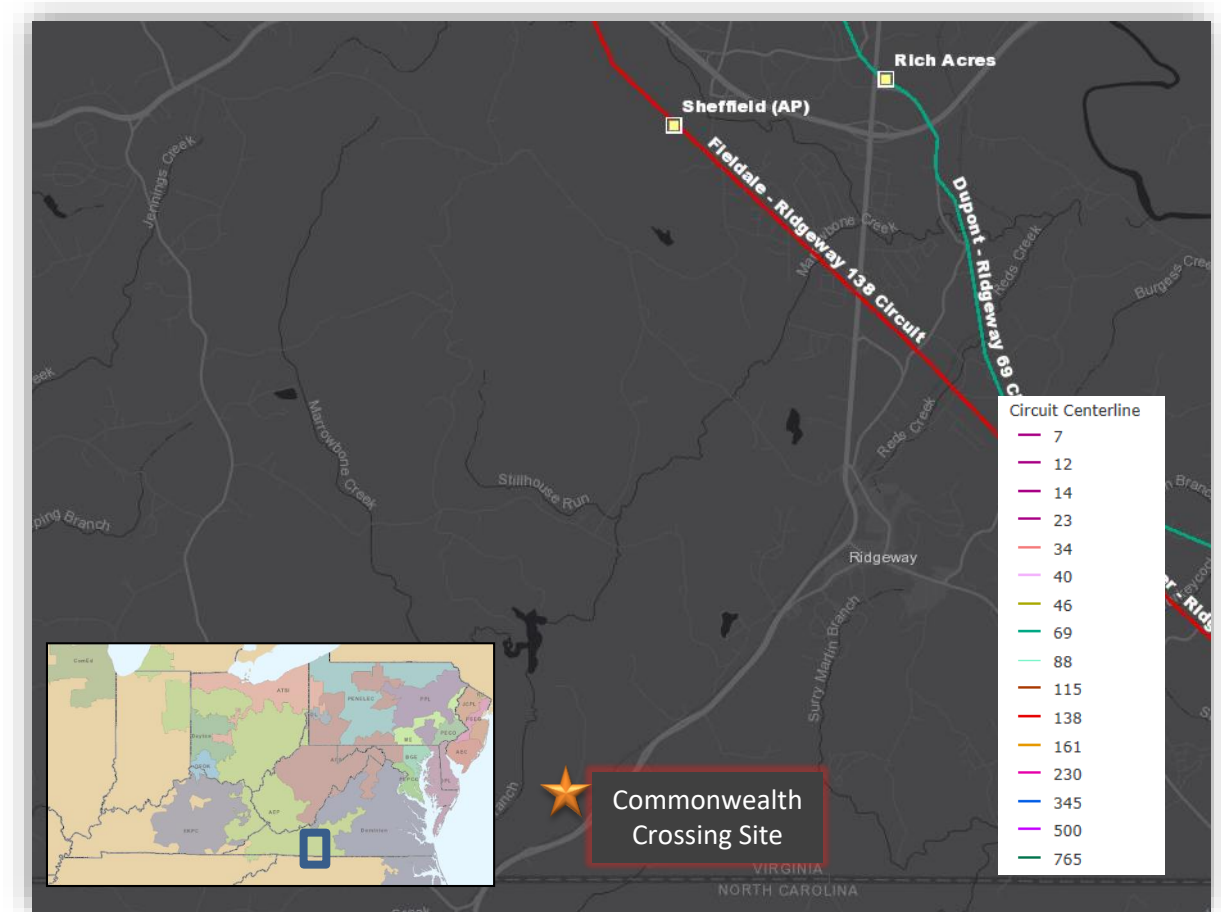

AEP Transmission Zone M-3 Process Commonwealth Crossing

Need Number: AEP-2019-AP045

Process Stage: Submission of Supplemental Project for inclusion in the Local Plan 04/10/2020

Selected Solution:

- Construct ~5.75 miles of new double circuit 138 kV line from the Fieldale-Ridgeway 138 kV circuit to a new Commonwealth Crossing station. **(S2191.1) Estimated Cost: \$14.8M**
- Establish a new 138/34.5 kV Commonwealth Crossing Station with 2-138 kV, 3000 A, 40 kA circuit breakers, high-side 3000 A, 40 kA circuit switcher, 138/34.5 kV, 30 MVA transformer, and 3-34.5 kV distribution feeders. **(S2191.2) Estimated Cost: \$0**
- Install 5.75 miles of 48 ct. fiber between Commonwealth Crossing station and Ridgeway station to support SCADA and relaying. **(S2191.3) Estimated Cost: \$0.4M**

Ancillary Benefits: The new station will provide a reliable source to the Commonwealth Crossing Business Centre (CCBC) which will be ready to accommodate new customers as needed.

Estimated Cost: \$15.2 M

Projected In-Service: 3/1/2020

Supplemental Project ID: S2191.1-.3

Project Status: Construction

Model: 2024 RTEP

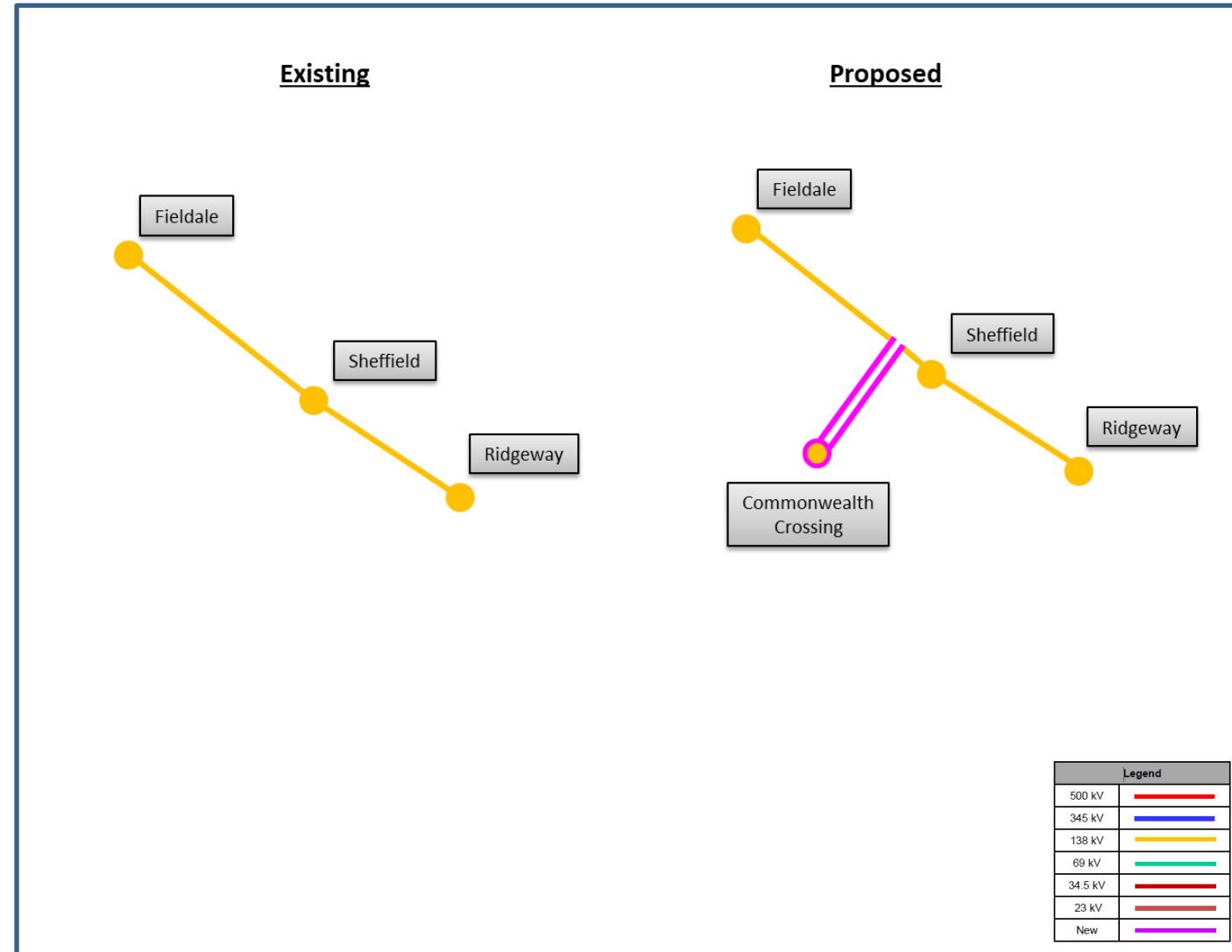

AEP Transmission Zone M-3 Process

Reusens – Altavista Rebuild

Need Number: AEP-2019-AP050

Process Stage: Submission of Supplemental Project for inclusion in the Local Plan 04/10/2020

Previously Presented:

Needs Meeting 11/22/2019

Solutions Meeting 2/21/2020

Project Driver:

Equipment Material/Condition/Performance/Risk

Specific Assumption Reference:

AEP Guidelines for Transmission Owner Identified Needs (AEP Assumptions Slide 8)

Problem Statement:

• **Reusens-Altavista 138 kV Line Asset (11.6 mi.)**

- A total of 16 open conditions on 13 unique structures (comprising 18% of the line asset)
- New London-Reusens 138 kV Circuit: From 2015-2018, a total of 2 permanent and 2 momentary outages occurred
- McConville-Reusens 138 kV Circuit: From 2015-2018, a total of 2 permanent and 2 momentary outages occurred
 - **138 kV Double Circuit Section (5.5 mi.)**
 - Section exists between Reusens Station and structure 5-10
 - 1949 steel lattice structures
 - The lattice towers used on this line are approximately 70 years old, which exceeds the projected life span for that structure type. Structure loading does not comply with the NESC 250B and 250D standards for the line.
 - The shield wire and most of the conductor is 70 years old as well, which exceeds the expected life span of the conductor. The current shielding does not comply with the current standards, specifying a maximum of 30 degrees. The current shielding angle is approximately 50 degrees.
 - **138 kV Single Circuit Section (6.1 mi.)**
 - Section exists between structure 5-10 and New London Station
 - 1949 wood H-Frame construction
 - The wood structures used on this line are approximately 70 years old, which exceeds the projected life span for that structure type. Structure loading does not comply with the NESC 250B and 250D standards for the line.
 - The shield wire and most of the conductor is 70 years old as well, which exceeds the expected life span of the conductor.
 - The current shielding does not comply with the current standards, specifying a maximum of 30 degrees. The current shielding angle is approximately 50 degrees.

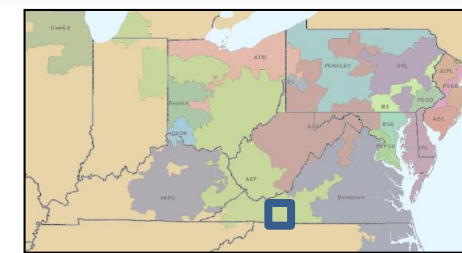
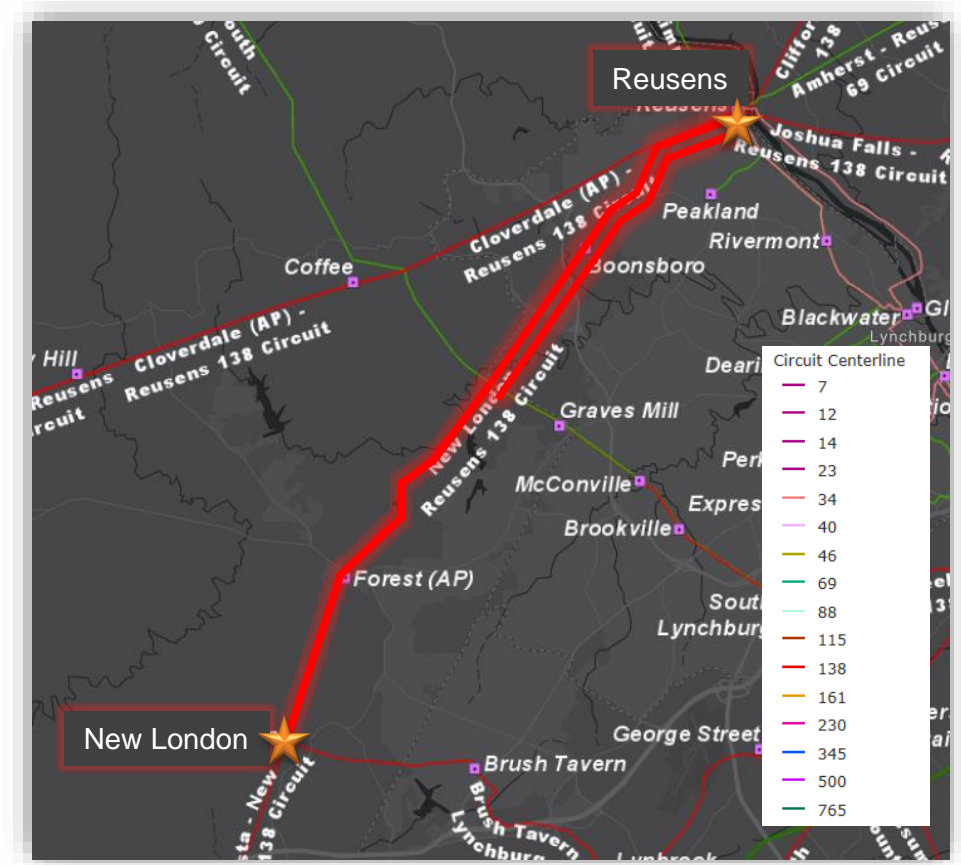

AEP Transmission Zone M-3 Process Reusens – Altavista Rebuild

Need Number: AEP-2019-AP050

Process Stage: Submission of Supplemental Project for inclusion in the Local Plan 04/10/2020

Selected Solution:

- Rebuild 11.6 mile section of the Reusens-Altavista 138 kV line asset from Reusens to New London. Approximately 5.5 miles consists of double circuit 138 kV construction and approximately 6 miles consists of single circuit 138 kV construction between Reusens and New London. **(S2192.1)**

Estimated Cost: \$36.2M

- Install a 57.6 MVAR cap bank at Brush Tavern due to low voltage concerns from operations during construction outages in the area. **(S2192.2) Estimated Cost: \$0.0M**

Estimated Cost: \$36.2 M

Projected In-Service: 10/31/2022

Supplemental Project ID: S2192.1-.2

Project Status: Scoping

Model: N/A

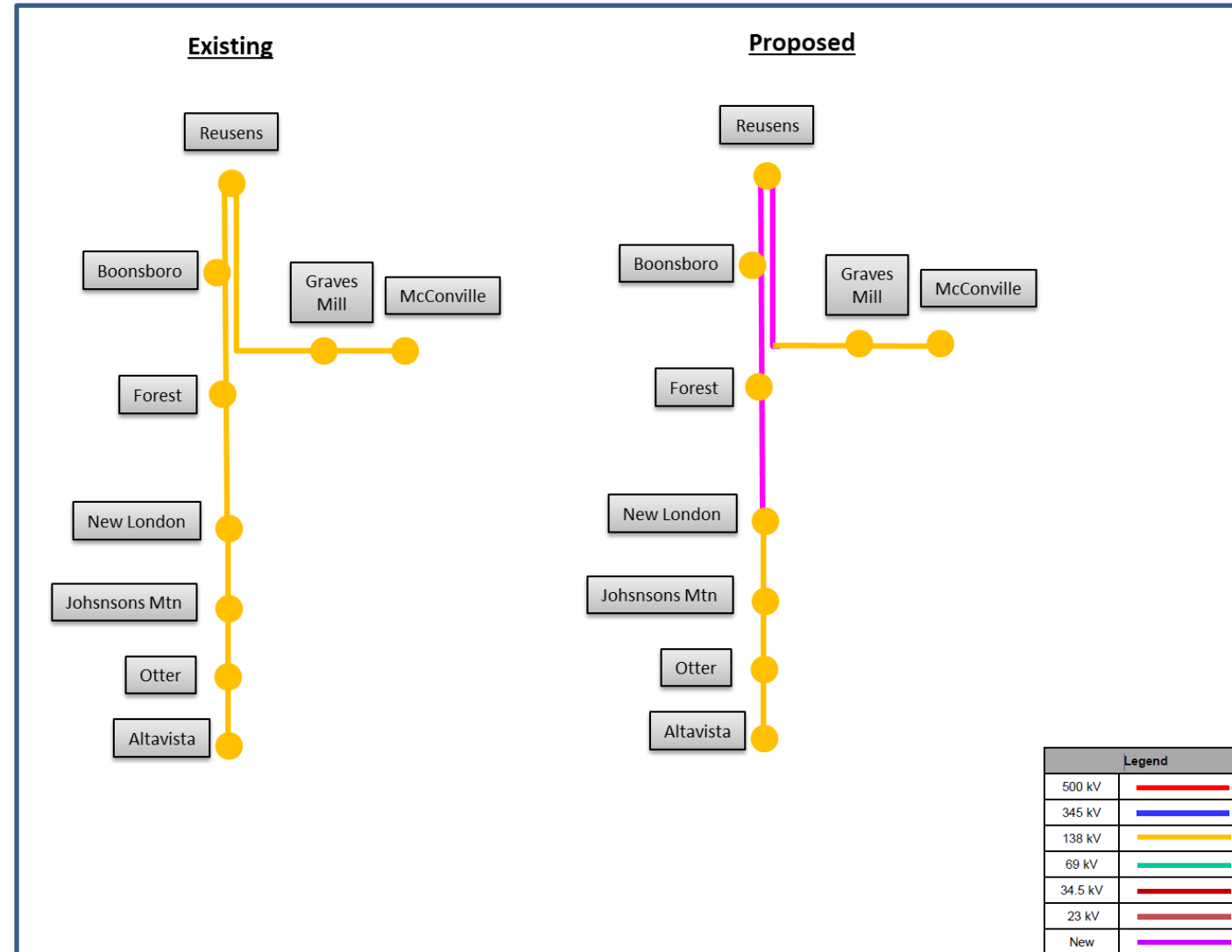

AEP Transmission Zone M-3 Process Illinois Road Station Improvements

Need Number: AEP-2019-IM012

Process Stage: Submission of Supplemental Project for inclusion in the Local Plan 04/10/2020

Previously Presented:

Needs Meeting 3/28/2019

Solution Meeting 2/21/2020

Project Driver:

Equipment Material/Condition/Performance/Risk

Specific Assumption Reference:

AEP Guidelines for Transmission Owner Identified Needs (AEP Assumptions Slide 8)

Problem Statement:

Illinois Road 138kV station

- Breakers A & B 69kV
 - 1969 and 1970 vintage Oil breakers
 - Fault Operations: A(23) & B(67) – Recommended(10)
 - Oil filled breakers have much more maintenance required due to oil handling that their modern, vacuum counterparts do not require. Finding spare parts for these units is difficult or impossible, and these models are no longer vendor supported

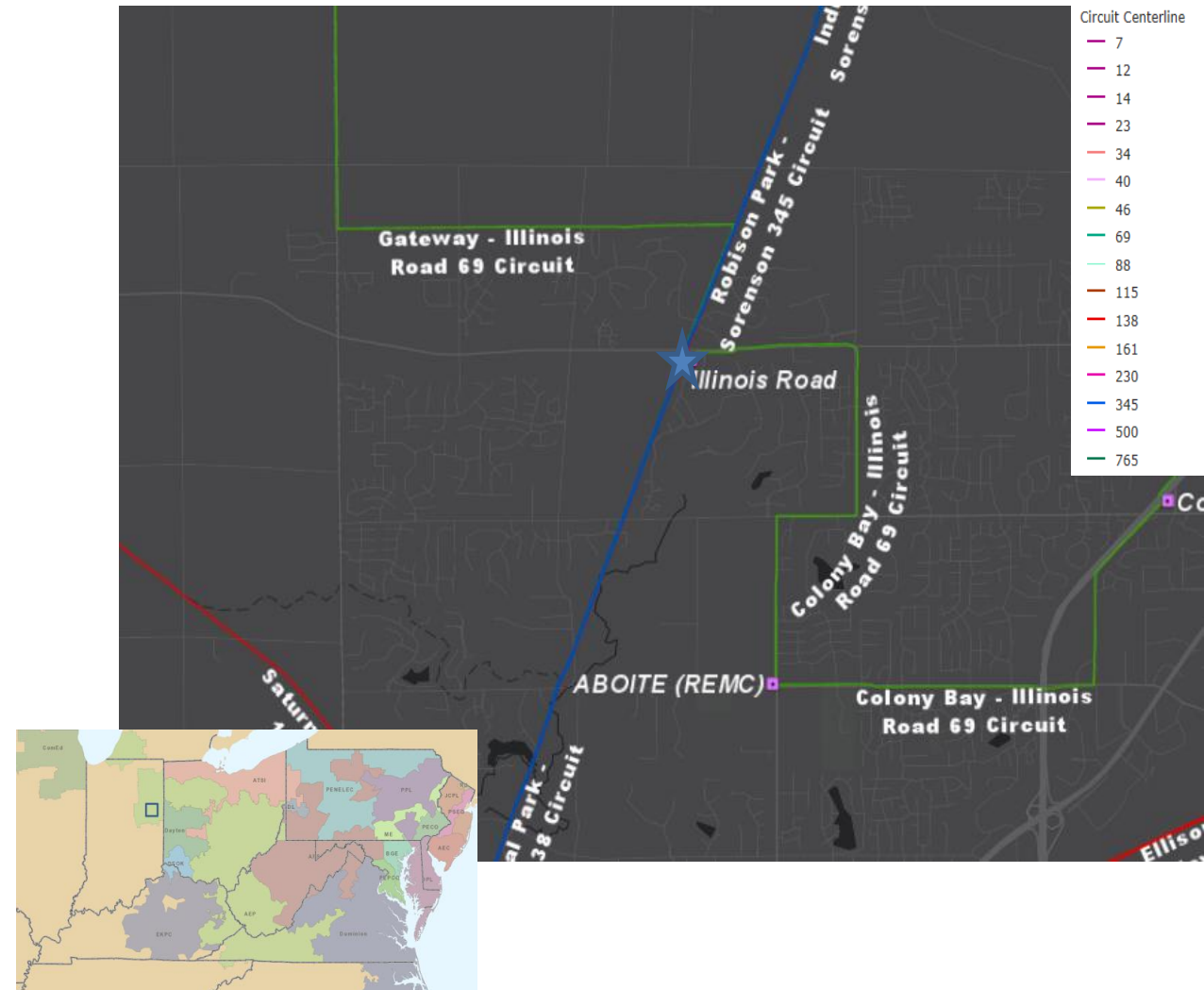

AEP Transmission Zone M-3 Process Illinois Road Station Improvements

Need Number: AEP-2019-IM012

Process Stage: Submission of Supplemental Project for inclusion in the Local Plan 04/10/2020

Selected Solution:

Replace 69kV CB's A and B and add a low side 69kV CB. Add 2 138kV CB's on the line exits.

Ancillary Benefits: Since the outage on the 138/69kV XFR was required, AEP decided to take the time to install the low side 69kV CB and high side 138kV CB's in order to bring the station up to the current protection standard. **S2193**

Estimated Cost: \$5.9 M

Projected In-Service: 11/10/2021

Supplemental Project ID: S2193

Project Status: Scoping

Model: N/A

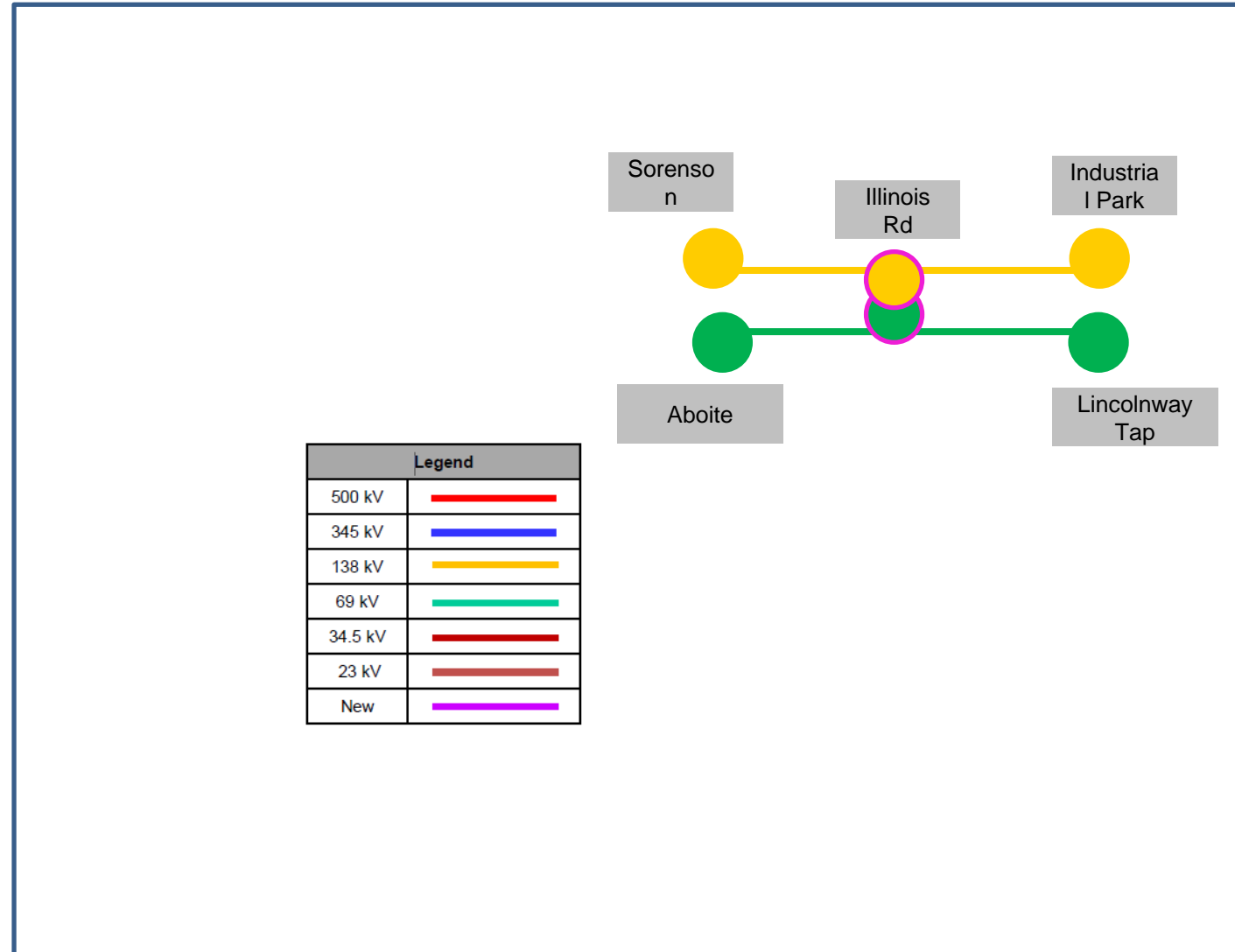

AEP Transmission Zone M-3 Process Adams & Pennville Station Rehab

Need Number: AEP-2019-IM019

Process Stage: Submission of Supplemental Project for inclusion in the Local Plan
04/10/2020

Previously Presented:

Needs Meeting 06/17/2019
Solution Meeting 2/21/2020

Project Driver:

Equipment Material/Condition/Risk/Performance/

Specific Assumption Reference:

AEP Guidelines for Transmission Owner Identified Needs (AEP Assumptions Slide 8)

Problem Statement:

Adams 138/69kV station

- The 138/69kV XFR currently is protected by a high side ground switching MOAB.
- Currently there are 3 dissimilar zones of protection at this station with a 138kV line, 138kV bus and a 138/69kV transformer

Pennville 138kV station

- This station's through path is composed of wood support structures and cap and pin bus insulators, both have been identified as safety concerns.
- The Cap and Pin support insulators have a documented history of failing due to degradation in the glue that holds them together. It is currently AEP policy to remove these support style insulators as we have opportunity.
- The support structures for the station's through path reside mostly outside of the station footprint. These bus support structures straddle the station fence which leaves most of the main bus, switches, insulators and support structures outside the station's footprint where there is no ground grid. This has been identified as a safety hazard and will be addressed.

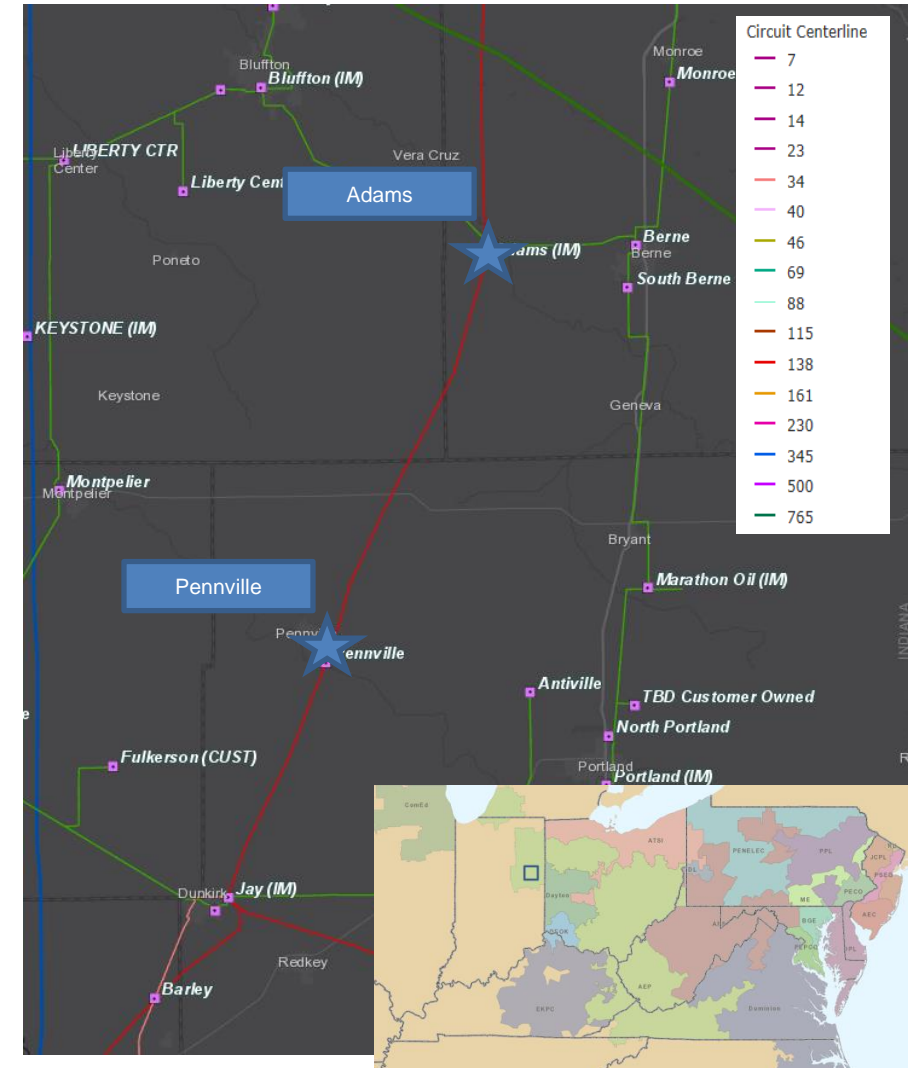

AEP Transmission Zone M-3 Process Adams & Pennville Station Rehab

Need Number: AEP-2019-IM027

Process Stage: Submission of Supplemental Project for inclusion in the Local Plan
04/10/2020

Previously Presented:

Needs Meeting 08/29/2019

Solution Meeting 2/21/2020

Project Driver:

Equipment Material/Condition/Risk/Performance

Specific Assumption Reference:

AEP Guidelines for Transmission Owner Identified Needs (AEP Assumptions Slide 8)

Problem Statement:

Adams 69kV Station:

69kV Circuit Breaker D

- Vintage 1966 Oil filled McGraw Edison CF type breaker
- Last oil breaker at Adams station
- Oil filled breakers have much more maintenance required due to oil handling that their modern, vacuum counterparts do not require
- Spare parts are not available and these models are no longer vendor supported
- Fault operations (10) – Manufacturers recommended maximum (10)

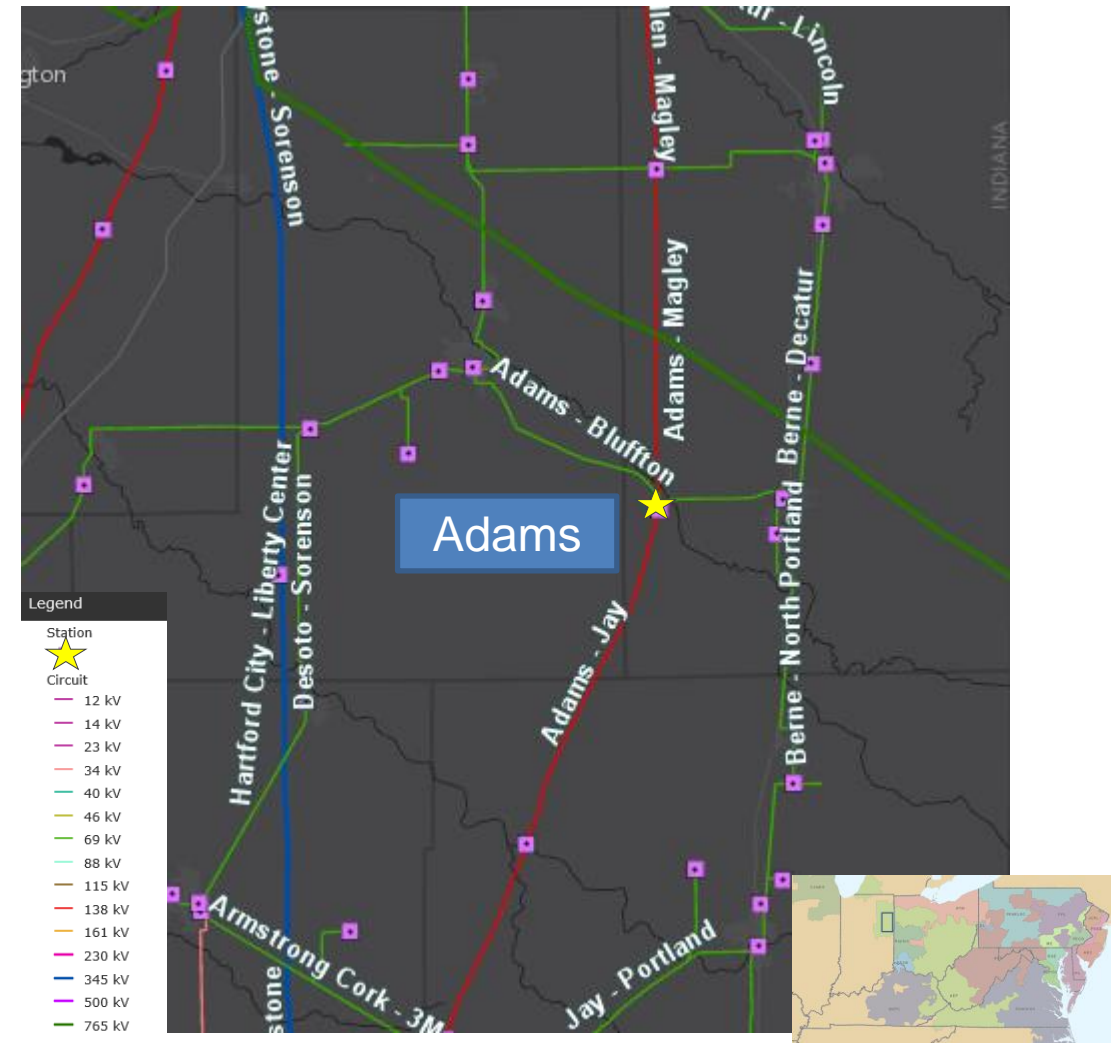

AEP Transmission Zone M-3 Process Adams & Pennville Station Rehab

Need Number: AEP-2019-IM019 & AEP-2019-IM027

Process Stage: Submission of Supplemental Project for inclusion in the Local Plan 04/10/2020

Selected Solution:

Rebuild the high side of Adams 138/69kV station as a 3 breaker ring bus, re-using the existing breaker “C,” and replace 69kV Breaker “D”

(S2194.1) Estimated Cost: \$6.3M

Rebuild the through-path of Pennville 138kV station with 2 MOABS

(S2194.2) Estimated Cost: \$1.7M

Total Estimated Transmission Cost: \$8 M

Projected In-Service: 1/2/2026

Supplemental Project ID: S2194.1-.2

Project Status: Scoping

Model: N/A

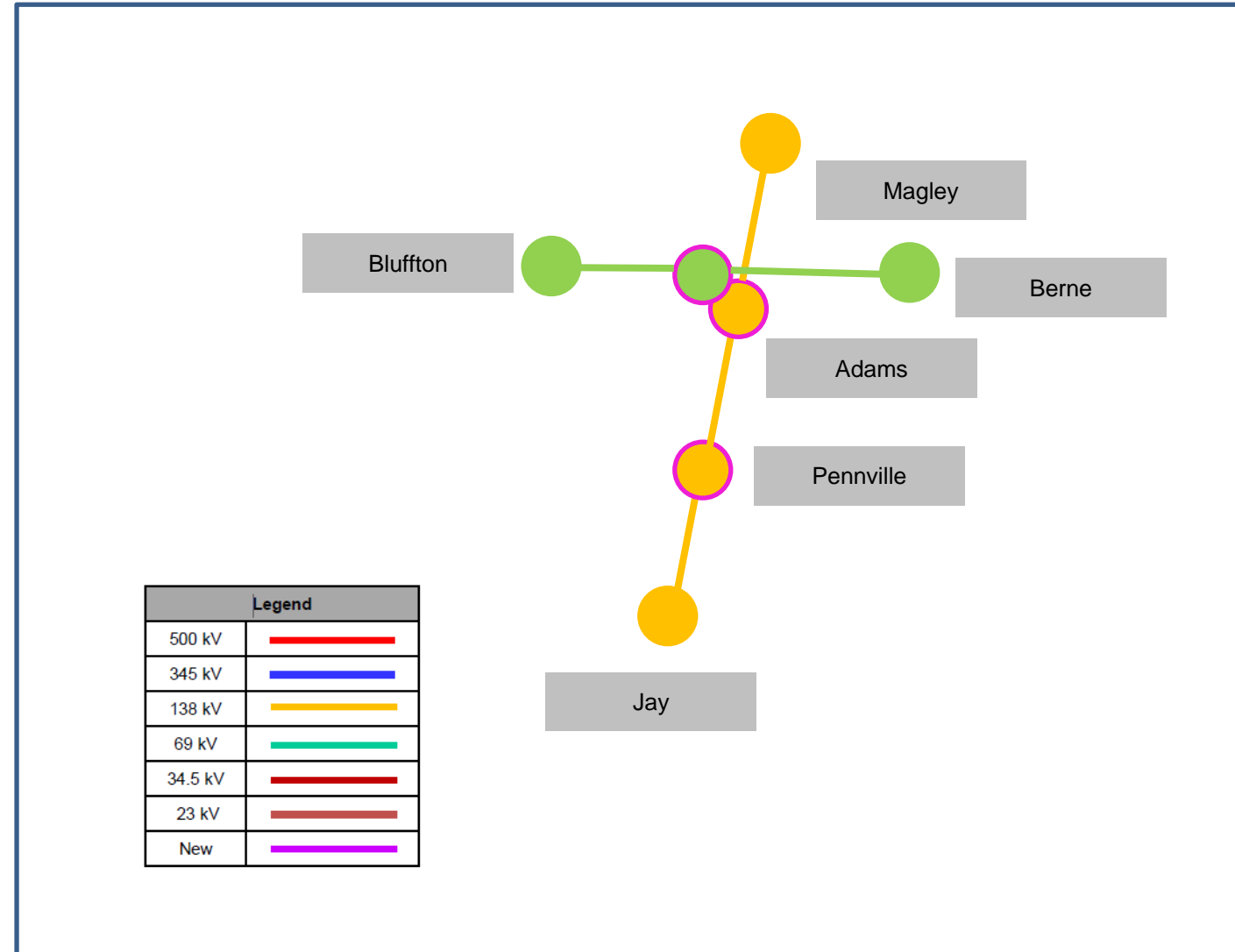

AEP Transmission Zone M-3 Process West Side Station Improvements

Need Number: AEP-2019-IM034

Process Stage: Submission of Supplemental Project for inclusion in the Local Plan
04/10/2020

Previously Presented:

Needs Meeting 9/25/2019

Solution Meeting 2/21/2020

Project Driver:

Equipment Condition/Performance/Risk

Specific Assumption Reference:

AEP Guidelines for Transmission Owner Identified Needs (AEP Assumptions Slide 8)

Problem Statement:

West Side 138kV Station

- Three terminal line
 - Three-terminal lines are very challenging to protect/coordinate and mis-operation or switching error become much more significant.
- Bus Tie Switch between the distribution transformers
 - Bus Tie Switch when operated without de-energizing the whole bus jeopardizes the Bus Differential Protection.
 - With no Bus Differential Protection the correct interrupting device wouldn't operate during fault scenarios, this can be dangerous for people working in the station.

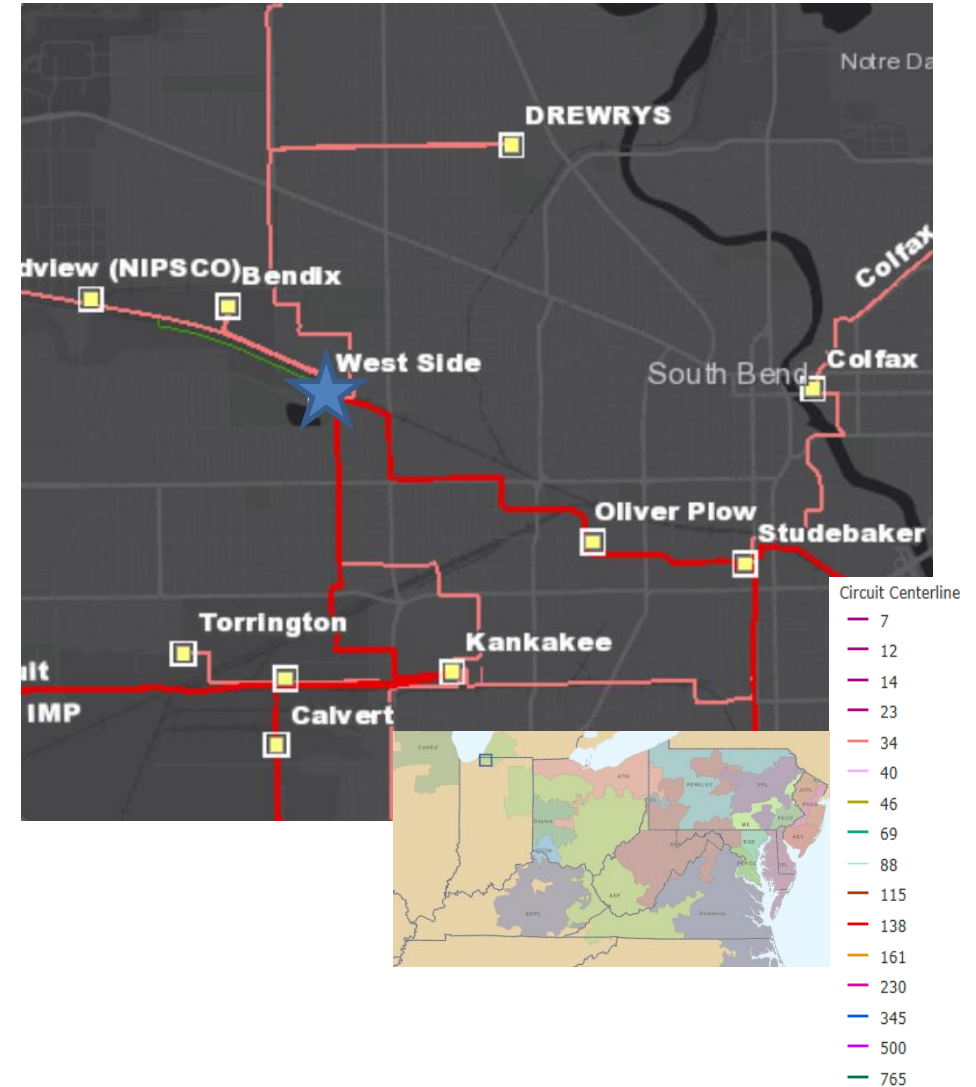

AEP Transmission Zone M-3 Process West Side Station Improvements

Need Number: AEP-2019-IM034

Process Stage: Submission of Supplemental Project for inclusion in the Local Plan 04/10/2020

Selected Solution:

Install 2 138kV line breakers at West Side station to break up the three-terminal line. Install 1 138kV bus tie breaker. Install one 69kV low-side breaker at Westside Station. (**S2195**)

Ancillary Benefits: While at the station, AEP will take advantage of the outage and also install a 69kV low side Transformer Circuit Breaker. This way the bus can remain in-service when the transformer goes out as the 69kV has more than one exit and the bus is a single bus single breaker.

Estimated Cost: \$3.5 M

Projected In-Service: 1/15/2021

Supplemental Project ID: S2195

Project Status: Scoping

Model: N/A

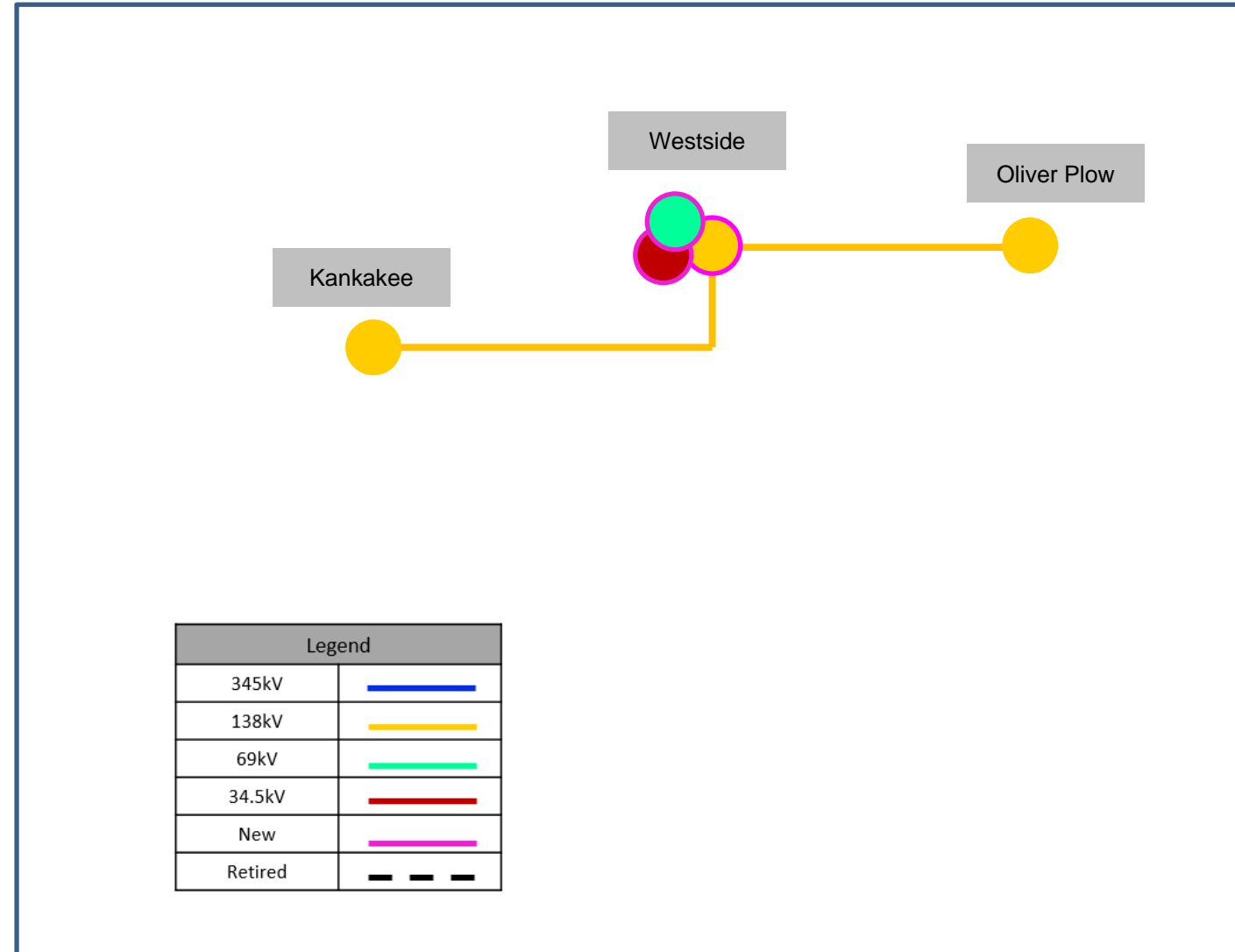

AEP Transmission Zone M-3 Process Ameriplex Station Solution

Need Number: AEP-2019-IM039

Process Stage: Submission of Supplemental Project for inclusion in the Local Plan 04/10/2020

Previously Presented:

Needs Meeting 10/25/2019

Solutions Meeting 2/21/2020

Project Driver:

Customer Service

Specific Assumption Reference:

AEP Interconnection Guidelines (AEP Assumptions Slide 7)

Problem Statement:

South Bend-Olive 138kV line-

- New 1.5MVA block load addition to the Ameriplex complex and new delivery point request from I&M distribution.
- Expected loading of 14MVA at Ameriplex distribution station. Future plans to double initial distribution configuration to allow for up to 25MVA load.

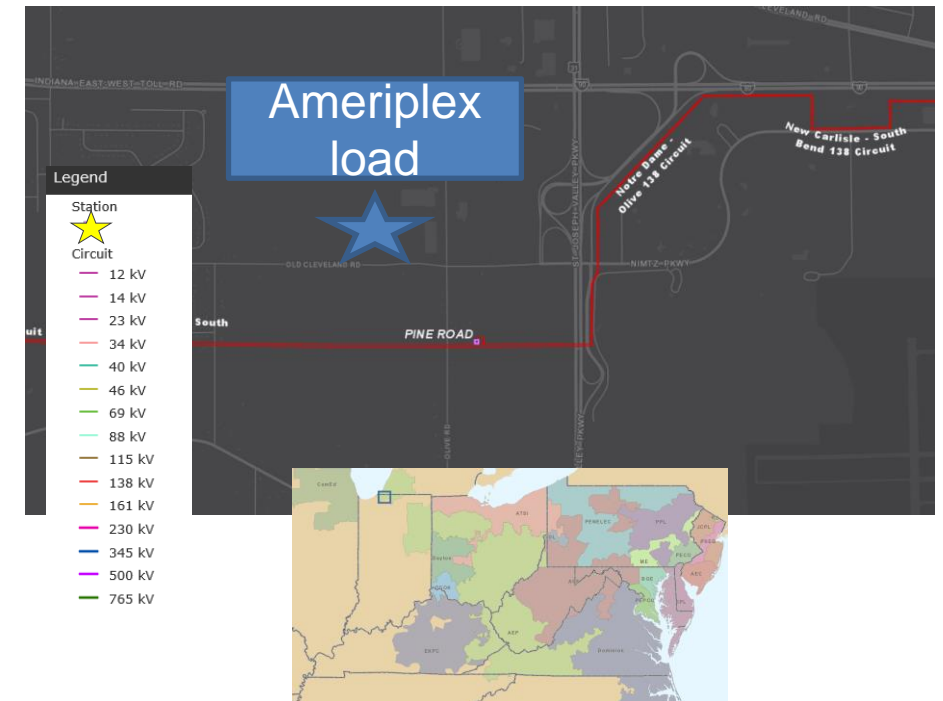

AEP Transmission Zone M-3 Process Ameriplex Station Solution

Need Number: AEP-2019-IM039

Process Stage: Submission of Supplemental Project for inclusion in the Local Plan 04/10/2020

Selected Solution:

Cut into the existing South Bend-New Carlisle 138kV line and install tap structures for the Ameriplex extension.

(S2196.1) Estimated Cost: \$0.7M

Install 1.75 miles of double circuit 138kV, 795 ACSR, off of the New Carlisle-South Bend 138kV line between New Carlisle and Pine road to serve new Ameriplex station.

(S2196.2) Estimated Cost: \$6.8M

Install new greenfield station Ameriplex on new greenfield Ameriplex 138kV tap off of the New Carlisle-South Bend 138kV line. The transmission through path consists of one 138kV breaker, one MOAB and one 138kV bus.

(S2196.3) Estimated Cost: \$2.1M

Estimated Cost: \$9.6 M

Projected In-Service: 6/1/2021

Supplemental Project ID: S2196.1-.3

Project Status: Scoping

Model: 2024 RTEP

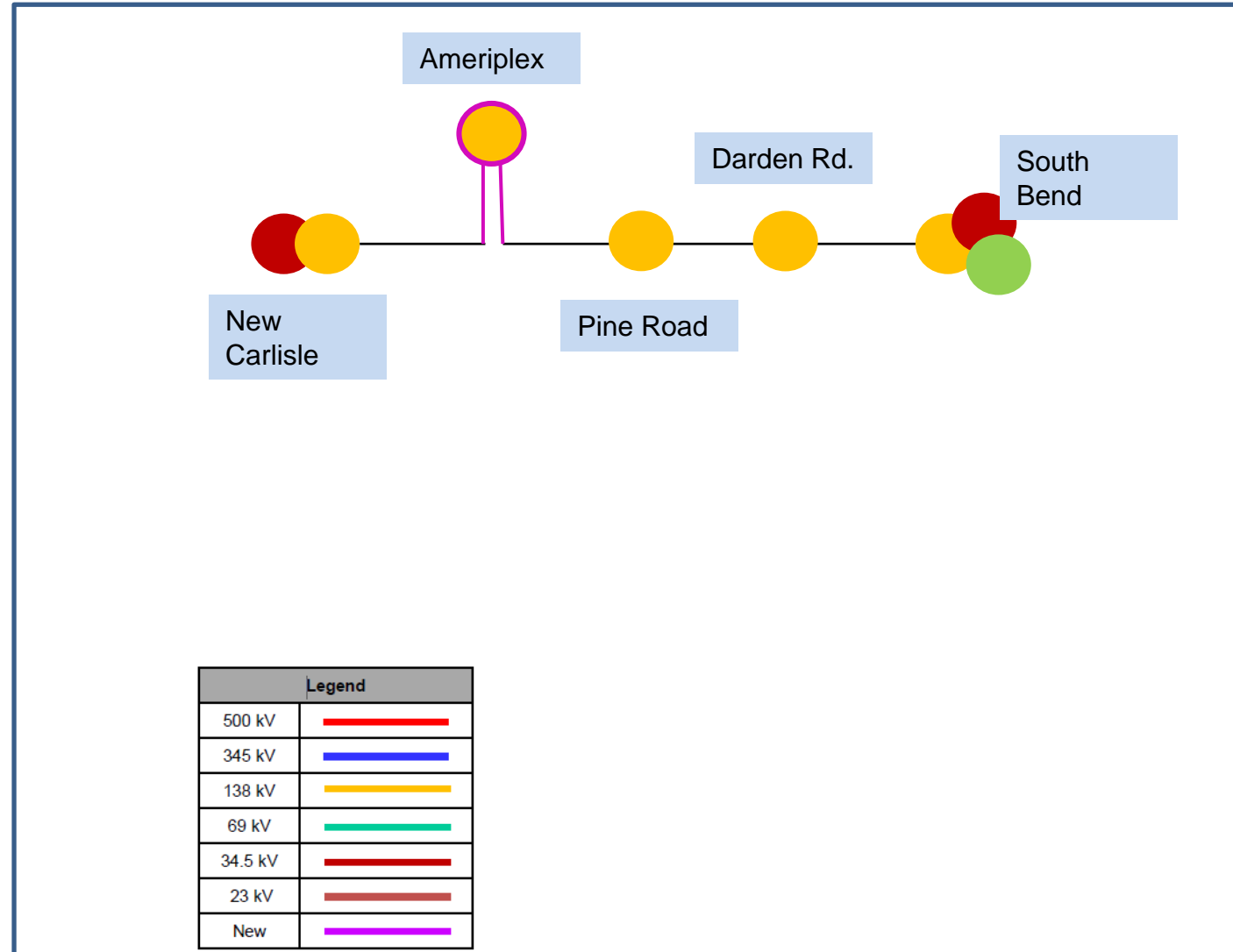

AEP Transmission Zone M-3 Process Dragoon Station

Need Number: AEP-2019-IM040

Process Stage: Submission of Supplemental Project for inclusion in the Local Plan 04/10/2020

Previously Presented:

Needs Meeting 10/25/2019

Solution Meeting 2/21/2020

Project Driver:

Equipment Material/Condition/Performance/Risk

Specific Assumption Reference:

AEP Connection Requirements for the AEP Transmission System (AEP Assumptions Slide 7)

Problem Statement:

Dragoon Station:

- The 34.5 kV Circuit Breakers A, C and D at Dragoon Station are GE 'FK' oil-filled breaker manufactured in 1968
- 17, 51 and 9 fault operations (manufacturer recommendation of 10)
- Oil filled Breakers without oil containment
- The breakers have the following documented conditions:
 - Bushing problems
 - Unavailability of spare parts
 - Fault operations count
 - High moisture readings
- Oil spills are frequent with failures and routine maintenance which is also an environmental hazard

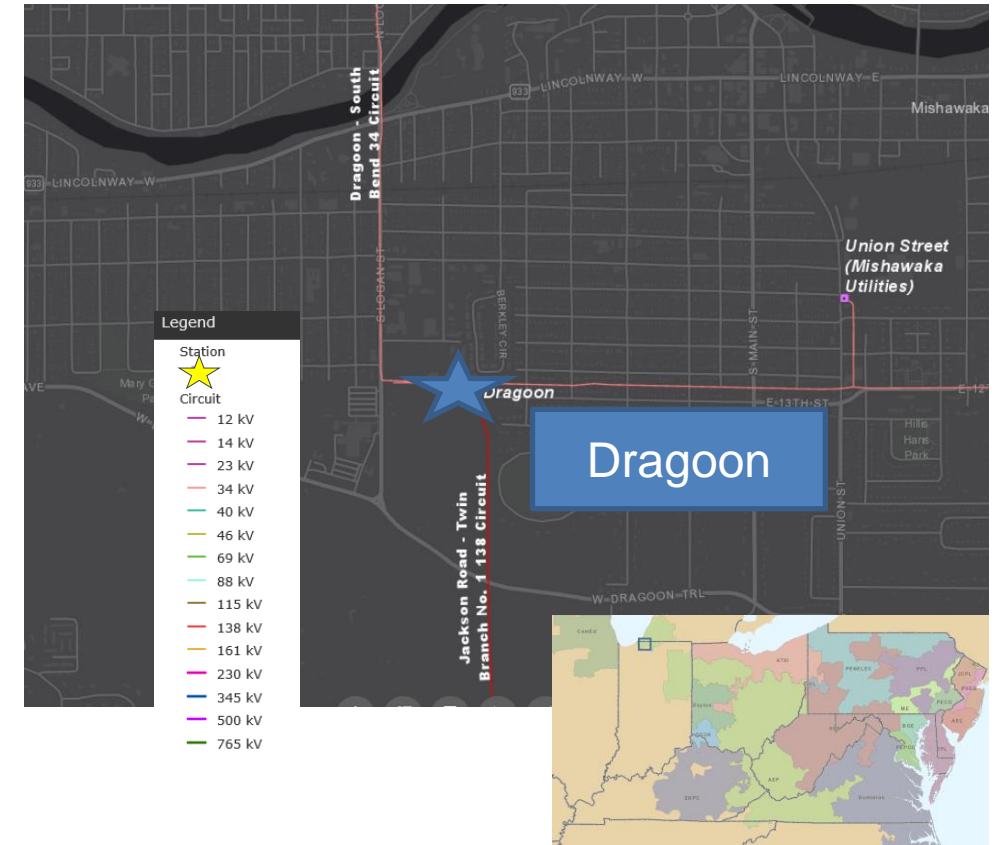

AEP Transmission Zone M-3 Process Dragoon Station

Need Number: AEP-2019-IM040

Process Stage: Submission of Supplemental Project for inclusion in the Local Plan 04/10/2020

Selected Solution:

At Dragoon Station, replace ~~3 69kV breakers A, C & D.~~

Replace the 34.5KV breaker A. (S2197)

Estimated Cost: ~~\$2 M~~ **\$0.66M**

Projected In-Service: 11/1/2020~~1~~

Supplemental Project ID: S2197

Project Status: Scoping

Model: N/A

NOTE: The breaker replacement for Dragoon Station 34.5kV breakers C and D are converted to baseline B3270.1



Dragoon

Legend	
500 kV	
345 kV	
138 kV	
69 kV	
34.5 kV	
23 kV	
New	

AEP Transmission Zone M-3 Process Falcon – Middle Creek

Need Number: AEP-2018-AP010

Process Stage: Submission of Supplemental Project for inclusion in the Local Plan 04/20/2020

Previously Presented:

Needs Meeting 11/29/2018

Solutions Meeting 12/18/2019

Project Driver:

Equipment Condition/Performance/Risk

Specific Assumption Reference:

AEP Guidelines for Transmission Owner Identified Needs (AEP Assumptions Slide 8)

Problem Statement:

From 2013-2018 the Falcon –Prestonsburg 46 kV circuit (~ 23 miles) has experienced 19 momentary and permanent outages. Over the last three years the circuit has experienced 1.77 million customer minutes of interruption. The ~14.5 mile 46 kV line section between Falcon and Middle Creek has 84 category A open conditions associated with the structures that make up the line. These conditions include damaged/rotted poles and damaged guy wires, cross arms. The majority of this line utilizes 1950s wood structures and 3/0 ACSR conductor. The ~8.5 mile 46 kV line section between Middle Creek and Prestonsburg has 27 category A open conditions associated with the structures that make up the line. These conditions include damaged/rotted poles and damaged guy wires, cross arms. About half the structures that make up the line are 1940s wood structures with the majority of the line utilizing 1/0 Cu. conductor.

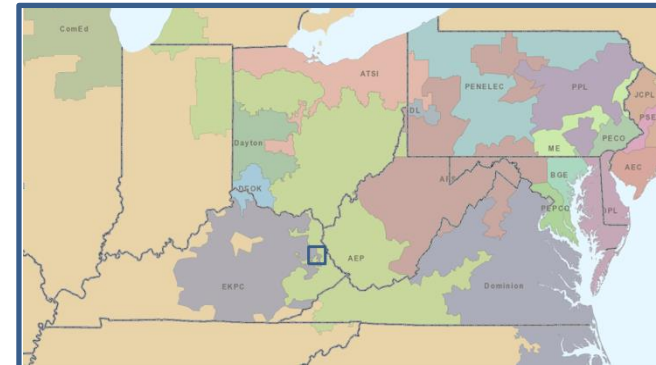

AEP Transmission Zone M-3 Process Falcon – Middle Creek

Need Number: AEP-2018-AP010

Process Stage: Submission of Supplemental Project for inclusion in the Local Plan 04/20/2020

Selected Solution:

- **Phase 1:**
 - Install a 2MW BESS at Middle Creek substation. (**S2200.1**) **Estimated Cost: \$9.7M**
- **Phase 2:**
 - Rebuild ~8.5 miles of 46 kV line between Prestonsburg and Middle Creek station. (**S2200.2**) **Estimated Cost: \$25.5M**
 - Retire ~14.5 miles of 46 kV line between Falcon and Middle Creek. (**S2200.3**) **Estimated Cost: \$6.1M**

Estimated Cost: \$41.3 M

Projected In-Service:

Phase 1: 12/1/2020

Phase 2: 4/1/2023

Supplemental Project ID: S2200.1-.3

Project Status: Scoping

Model: N/A

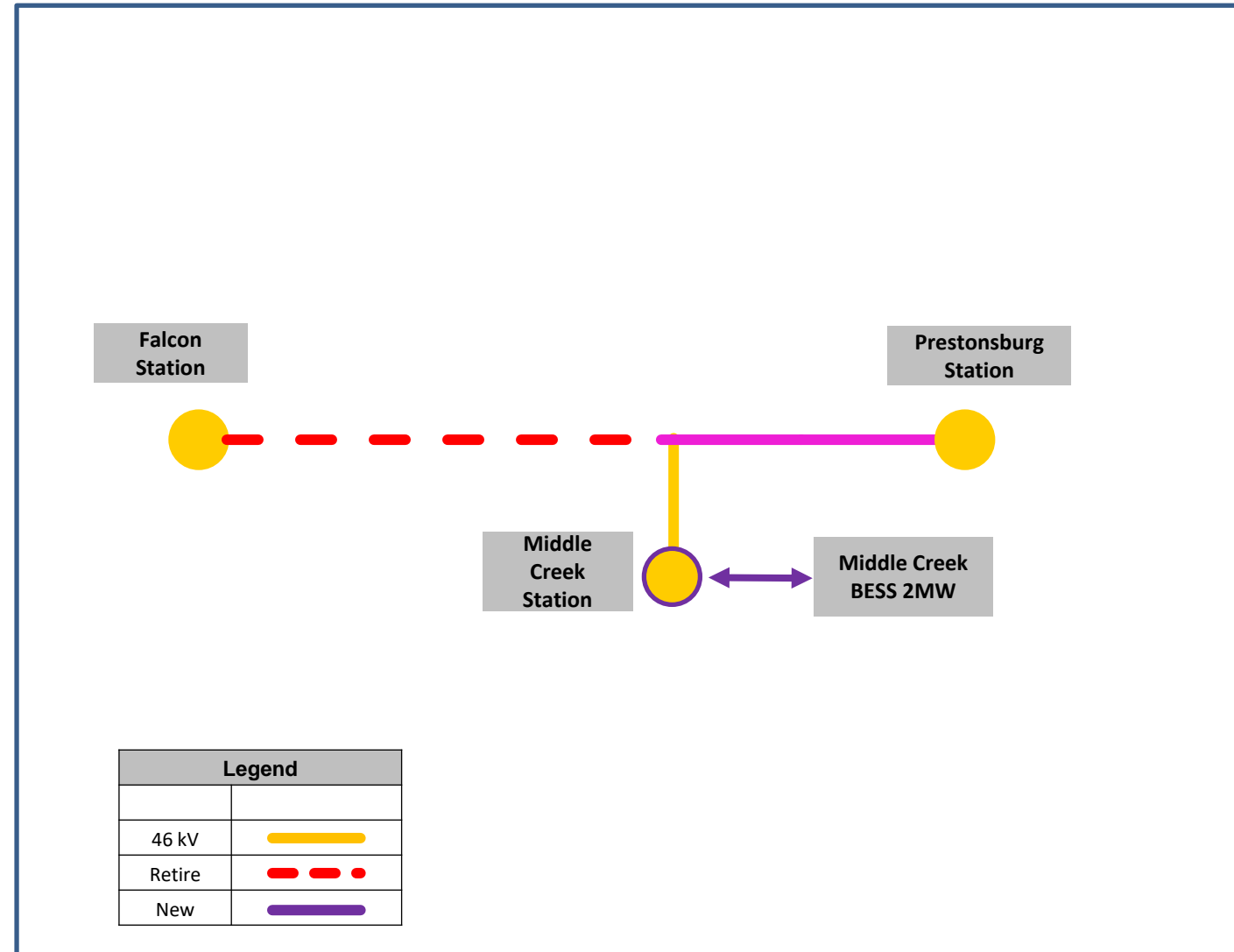

AEP Transmission Zone M-3 Process Hillsboro – Millbrook Park 138 kV Line Rebuild

Need Number: AEP-2019-OH024

Process Stage: Submission of Supplemental Project for inclusion in the Local Plan 04/20/2020

Previously Presented:

Needs Meeting 5/20/2019

Solutions Meeting 2/21/2020

Project Driver:

Equipment Condition/Performance/Risk

Specific Assumption Reference:

AEP Guidelines for Transmission Owner Identified Needs (AEP Assumptions Slide 8)

Problem Statement:

- The 1943 Hillsboro – Millbrook Park 138 kV circuit (~52 miles) is wood pole construction and has 1,342 open conditions.
- The majority (93%) of the original conductor (vintage 1944 & 1948) is 477 MCM (26/7) ACSR and is still in-service.
- Half of the wood pole structures from the 1940's are still in-service; the remaining are a mixture from 1960's – 1980's.
- There are additional concerns with the shielding, grounding, and hardware along this 52 mile long line.
- Sinking Springs is in a remote part of AEP's service territory making manual switching difficult.
- Originally installed in 1942-1943 timeframe. 98% of the line is on wood structures.
- Age Profile: 53% from 1940's; 4.4% from 1960's; 13% from 1970's; 27% from 1980's; 2.6% from 2000's

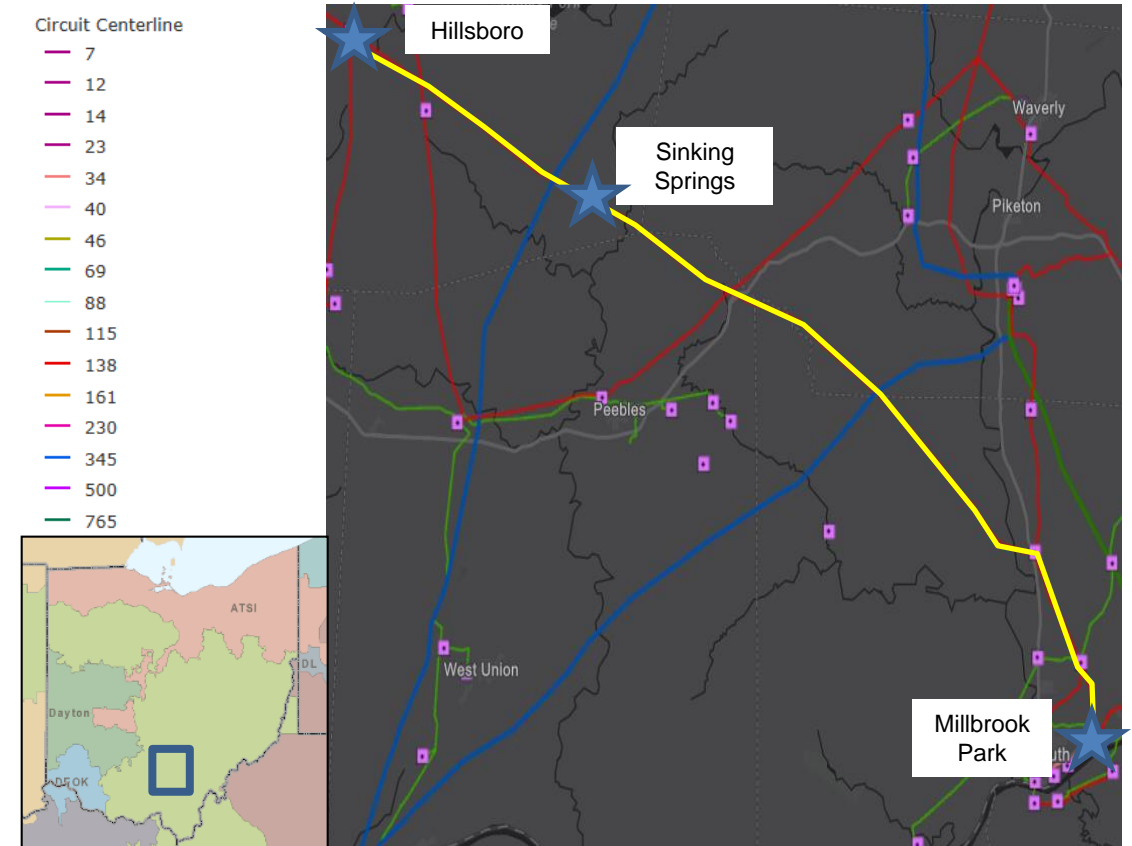

AEP Transmission Zone M-3 Process Hillsboro – Millbrook Park 138 kV Line Rebuild

Need Number: AEP-2019-OH024

Process Stage: Submission of Supplemental Project for inclusion in the Local Plan 04/20/2020

Selected Solution:

Portsmouth – Trenton #1 & #2 138kV Cost: \$126.1M

Rebuild 43.4 miles single circuit line between Hillsboro – South Lucasville with 1033 ACSR. **(S2201.1) Estimated Cost: \$92.5M**

Rebuild 8.5 miles double circuit between Millbrook Park – South Lucasville with 1033 ACSR. **(S2201.2) Estimated Cost: \$33.6M**

Install a new 3-way 2000A 138kV, phase over phase switch at Sinking Springs. **(S2201.3) Estimated Cost: \$0.7M**

Estimated Cost: \$126.8 M

Projected In-Service: 09/30/2022

Supplemental Project ID: S2201.1-.3

Project Status: Scoping

Model: N/A

Existing:

Legend	
500 kV	
345 kV	
138 kV	
69 kV	
34.5 kV	
23 kV	
New	

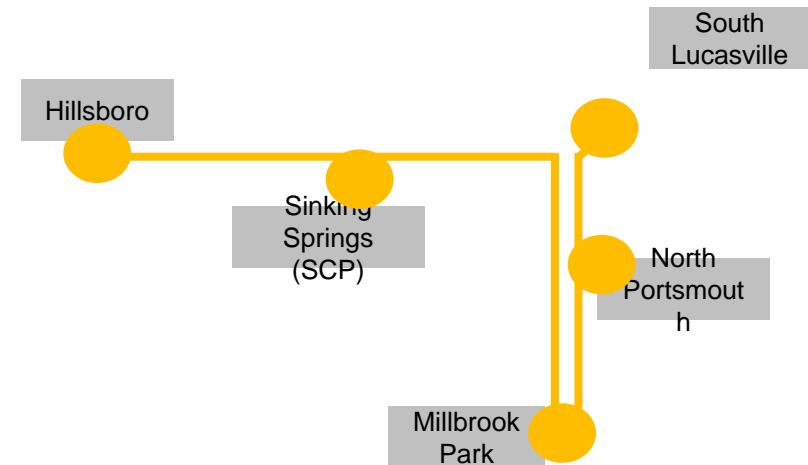

Proposed:

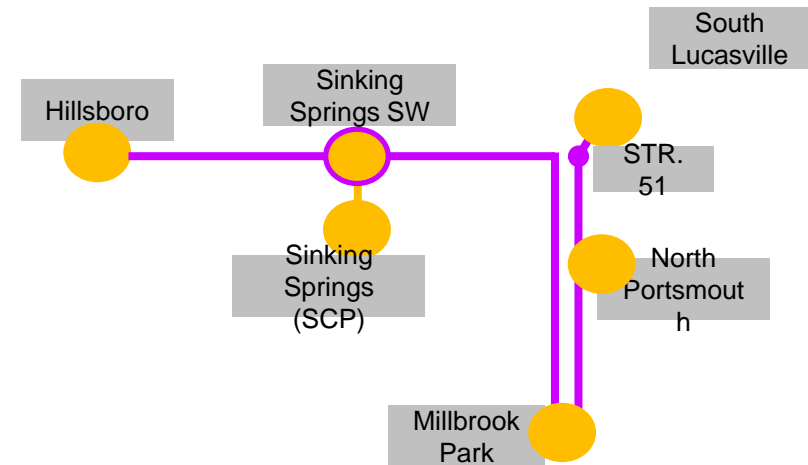

AEP Transmission Zone M-3 Process Cliffview Area Project

Need Number: AEP-2018-AP023

Process Stage: Submission of Supplemental Project for inclusion in the Local Plan
05/11/2020

Previously Presented:

Needs Meeting 01/11/2019

Solutions Meeting 3/19/2020

Project Driver:

Equipment Material/Condition/Performance/Risk

Specific Assumption Reference:

AEP Guidelines for Transmission Owner Identified Needs (AEP Assumptions Slide 8)

Problem Statement:

Wythe 138/69 kV transformer has experienced thermal through fault events, mostly in excess of 700°C, have led to numerous overheating events, steady increases in gasses including high levels of ethylene and ethane, and carbonization of the insulating paper. The oil's interfacial tension is showing signs of sludge beginning to form due to the carbonization created contaminants. In addition, the moisture content is beginning to climb which has not yet been reflected in a drop in dielectric strength. Wythe circuit breaker F is an FK type oil filled breaker. Oil filled breakers have much more maintenance required due to oil handling that their modern, SF6 counterparts do not require. The FK-439-115-3500-3 is no longer vendor supported and is 1 of 2 remaining on the AEP system, making spare parts difficult or impossible to acquire. Wythe circuit breaker M is a CF type oil filled breaker. Oil filled breakers have much more maintenance required due to oil handling that their modern, SF6 counterparts do not require. This particular unit has a recorded malfunction related to a broken S.S. line on the maintenance valve and pressure switches.

Continued on next slide

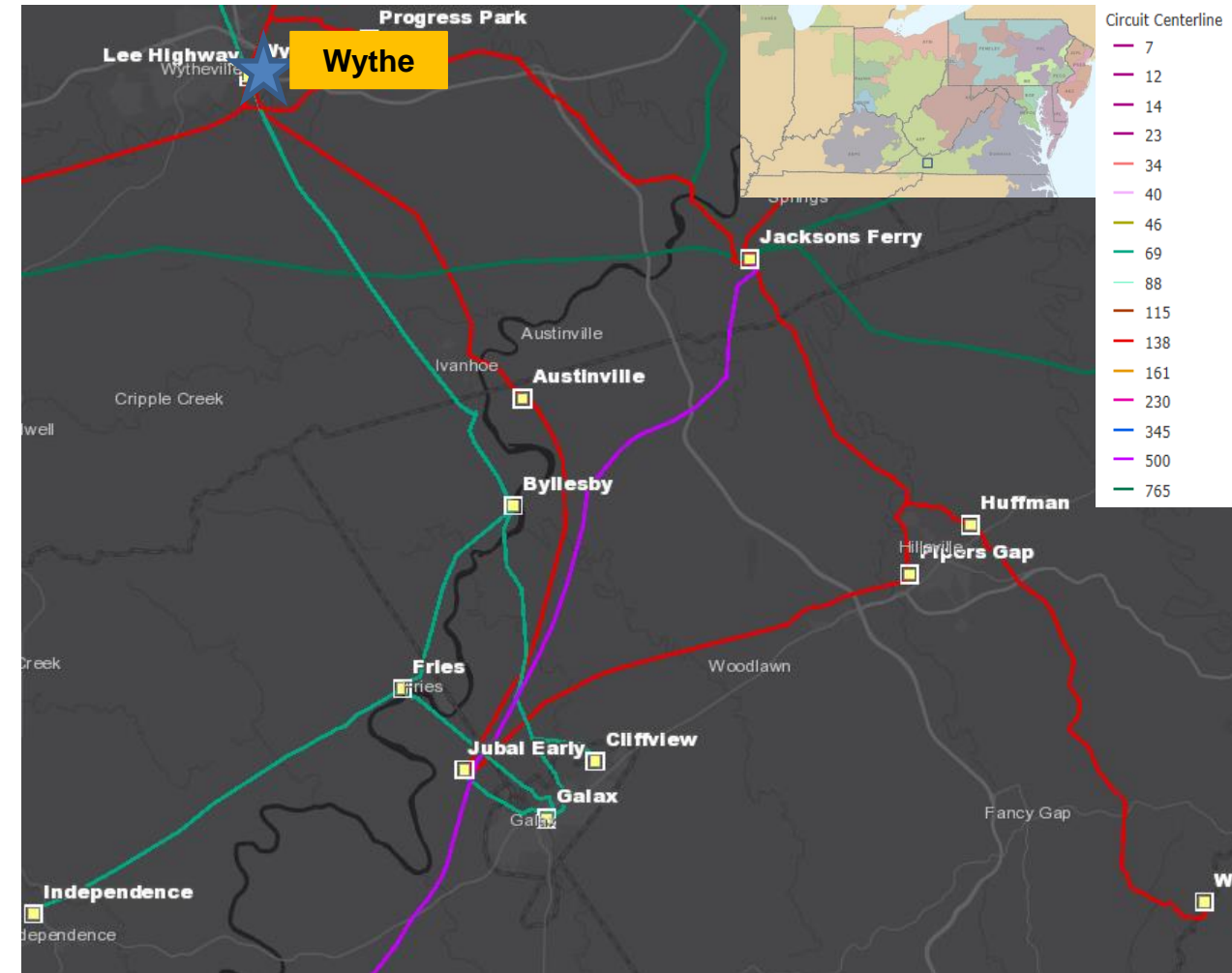

AEP Transmission Zone M-3 Process Cliffview Area Project

Need Number: AEP-2018-AP023 continued

Process Stage: Submission of Supplemental Project for inclusion in the Local Plan
05/11/2020

Previously Presented:

Needs Meeting 01/11/2019

Solutions Meeting 03/19/2020

Project Driver:

Equipment Material/Condition/Performance/Risk

Specific Assumption Reference:

AEP Guidelines for Transmission Owner Identified Needs (AEP Assumptions Slide 8)

Problem Statement:

Byllesby circuit breakers B and D are oil filled breakers manufactured in 1952 and 1965 respectively. Both breakers have exceeded the designed number of fault operations (10). These breakers are GE FK type oil breakers with no oil containment. The GE FK type breakers are known to have an internal operating mechanism that are prone to high failure rates.

Galax circuit breakers G, F, and H are all GE FK type oil breakers with no oil containment. The GE FK type breakers are known to have an internal operating mechanism that are prone to high failure rates. Circuit Breakers G, F, and H are all approximately 50 years old and have exceeded the designed number of fault operations (10).

Jubal Early 138/69kV Transformer has reoccurring bushing damage, dielectric strength breakdown (insulation breakdown) and short circuit breakdown (due to fault events). Recent test reports show oil interfacial tension to be below the minimum acceptable level for a unit of this voltage class. Reduction in oil interfacial tension is related to oil contamination and presence of oxidation byproducts in the oil.



AEP Transmission Zone M-3 Process Cliffview Area Project

Need Number: AEP-2018-AP023

Process Stage: Submission of Supplemental Project for inclusion in the Local Plan 05/11/2020

Selected Solution:

At Galax Station, replace existing 69 kV circuit breakers F, G, and H with new 40 kA 3000 A circuit breakers. **(S2214.1) Estimated Cost: \$0 (no transmission cost)**

At Byllesby Station, replace existing 69 kV circuit breakers B and D with new 40 kA 3000 A circuit breakers. **(S2214.2) Estimated Cost: \$ 4.7 M**

At Jubal Early Station, replace the existing 138/69/34.5 kV 75 MVA XFR with a new 138/69/34.5 kV 90 MVA XFR. **(S2214.3) Estimated Cost: \$1.6 M**

At Wythe Station, replace existing 138/69 kV 75 MVA XFR with a new 138/12 kV 20 MVA XFR, remove 69 kV CBs F and M, remove 69 kV bus and install 12 kV bus. Retire Lee Highway Station and serve load from Wythe. **(S2214.4) Estimated Cost: \$ 3.9M**

Ancillary Benefits: Wythe Station work allows for the retirement of the Lee Highway Station and consolidates the two stations by serving the 12 kV load from Wythe.

Estimated Cost: \$10.2M

Projected In-Service: 10/31/2021

Supplemental Project ID: S2214.1-.4

Project Status: Engineering

Model: N/A

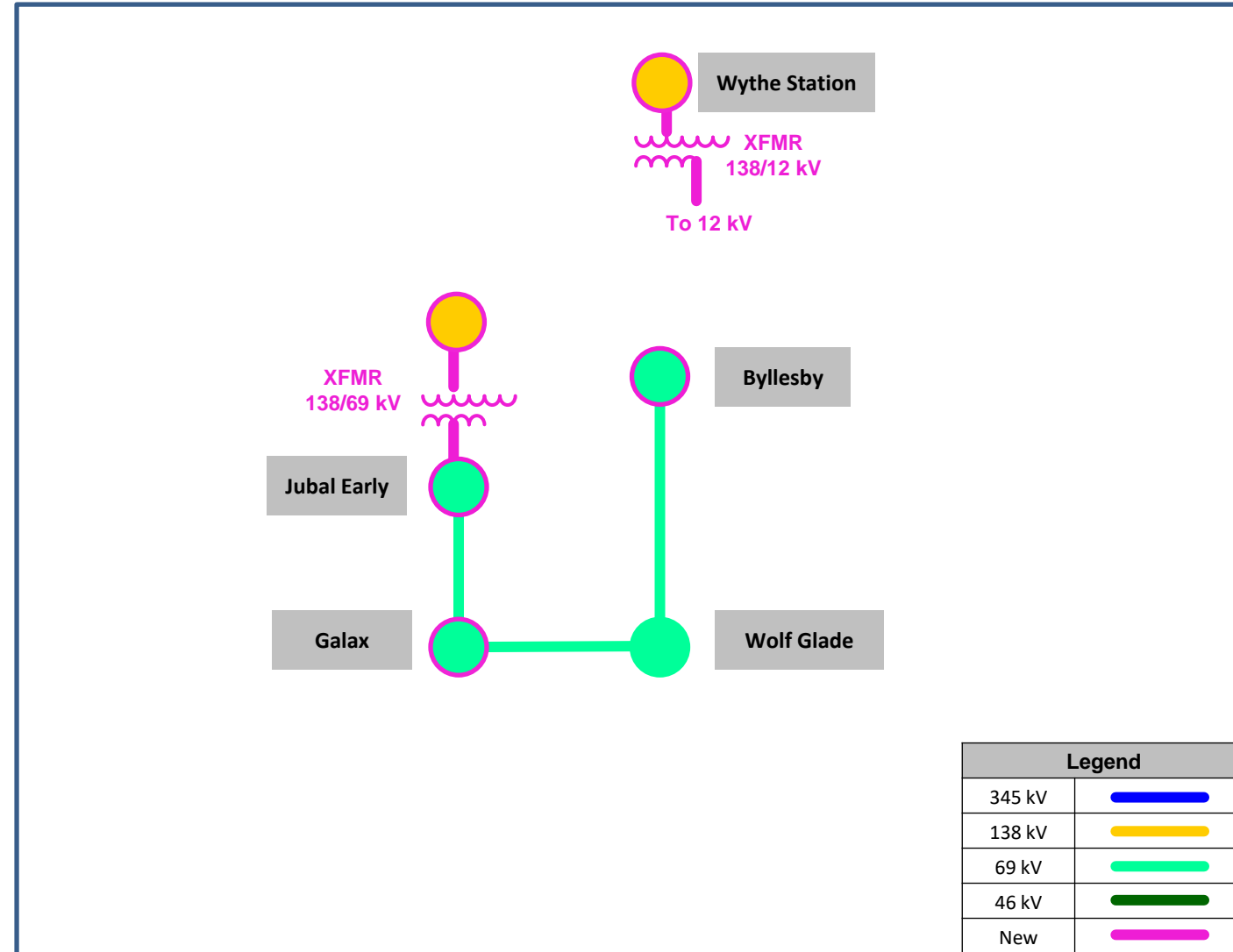

AEP Transmission Zone M-3 Process Fleming Station

Need Number: AEP-2019-AP007

Process Stage: Submission of Supplemental Project for inclusion in the Local Plan 05/11/2020

Previously Presented:

Needs Meeting 03/25/2019

Solutions Meeting 03/19/2020

Project Driver:

Equipment Material/Condition/Performance/Risk, Operational Flexibility and Efficiency

Specific Assumption Reference:

AEP Guidelines for Transmission Owner Identified Needs (AEP Assumptions Slide 8)

Problem Statement:

Fleming Station

- 138/69 kV Transformer #1
 - 1984 vintage transformer.
 - Shows signs of dielectric breakdown (insulation), accessory damage (bushings), and short circuit breakdown (due to through faults).
 - Reports from the field show active oil leaks from the gaskets and slight leaks from the unit's welds.
 - Utilizes a ground switch MOAB scheme as part of the high side transformer protection.
- 69/12 kV Transformer #3
 - 1979 vintage transformer.
 - Shows signs of dielectric breakdown (insulation), accessory damage (bushings), and short circuit breakdown (due to through faults).
- 69 kV Circuit Breakers B, E, and F
 - CF-48 type oil breakers. (1965, 1968, and 1967 vintage)
 - These are oil breakers that are difficult to maintain due to the required oil handling. There is an increased potential for oil spills during routine maintenance and failures with these types of breakers.
 - Other drivers include damage to bushings and an excessive number of fault operations exceeding the manufacturers recommendations.
 - Have experienced 114, 26, and 68 fault operations respectively. The manufacturer's recommendation for this type of breaker is 10.
 - This circuit breaker model family has experienced numerous documented mechanism bearing issues and failures within the AEP population. CBs B & F have had malfunction records indicating a failure to properly latch during operation.

Continued on next slide...

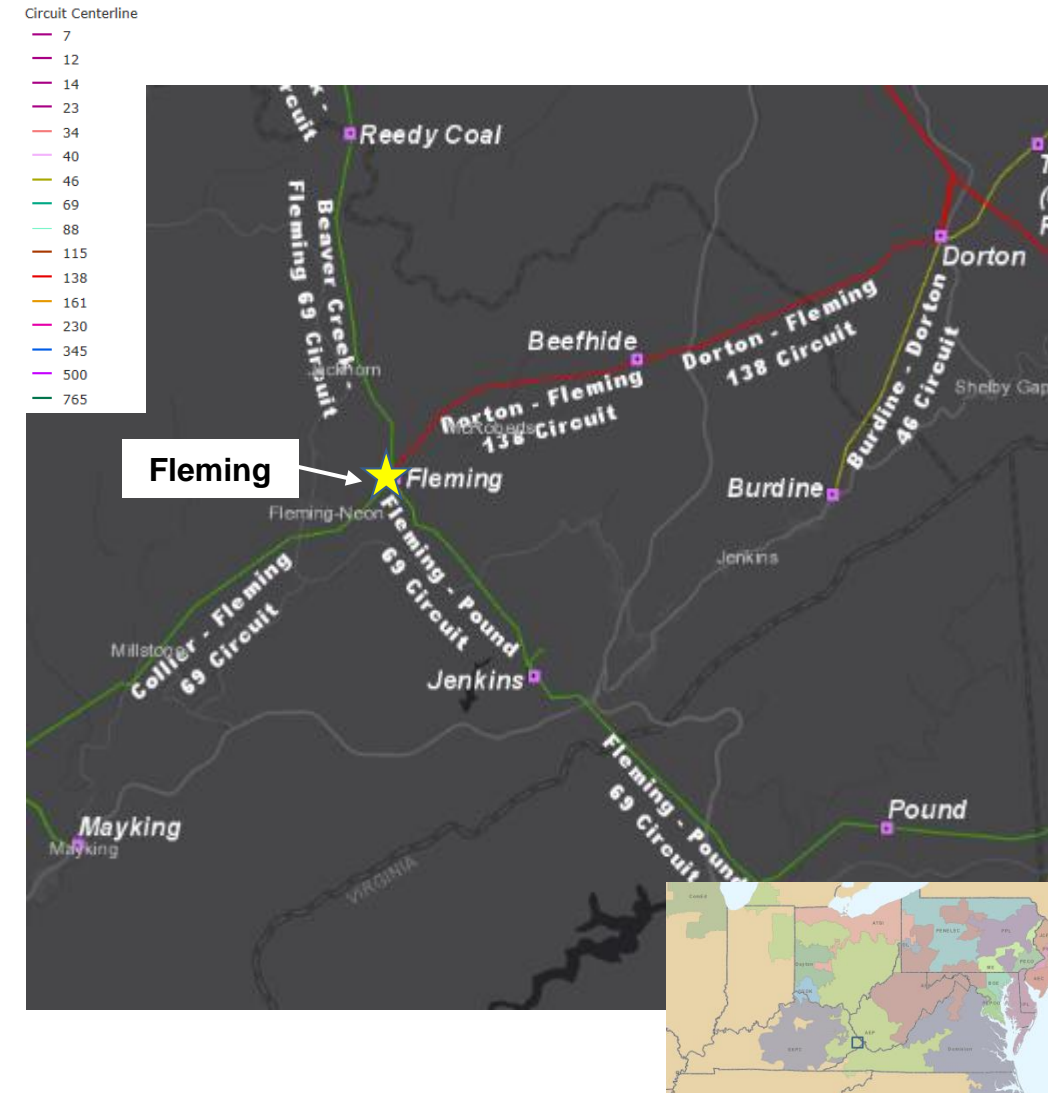

AEP Transmission Zone M-3 Process Fleming Station

Continued from previous slide...

Fleming Station

- S&C 69 kV Circuit Switcher 'AA'
 - No gas monitor, sister units on the AEP system have a history of gas loss, interrupter failures, and operating mechanism failures.
- 12 kV Circuit Breakers C and D
 - ES type oil breakers. (1979 vintage)
 - These are oil breakers that have become more difficult to maintain due to the required oil handling. There is an increased potential for oil spills during routine maintenance and failures with these types of breakers.
 - Have experienced 36 and 19 fault operations respectively. The manufacturer's recommendation for this type of breaker is 10.
- 69 kV Circuit Breaker A
 - 72EPB-31.5-20 SF6 type breaker with known gas leaks. (1990 vintage)
 - 18 malfunction records for this breaker since 2009 related to low gas alerts.
 - 1 of 12 remaining breakers of this type on the AEP system.

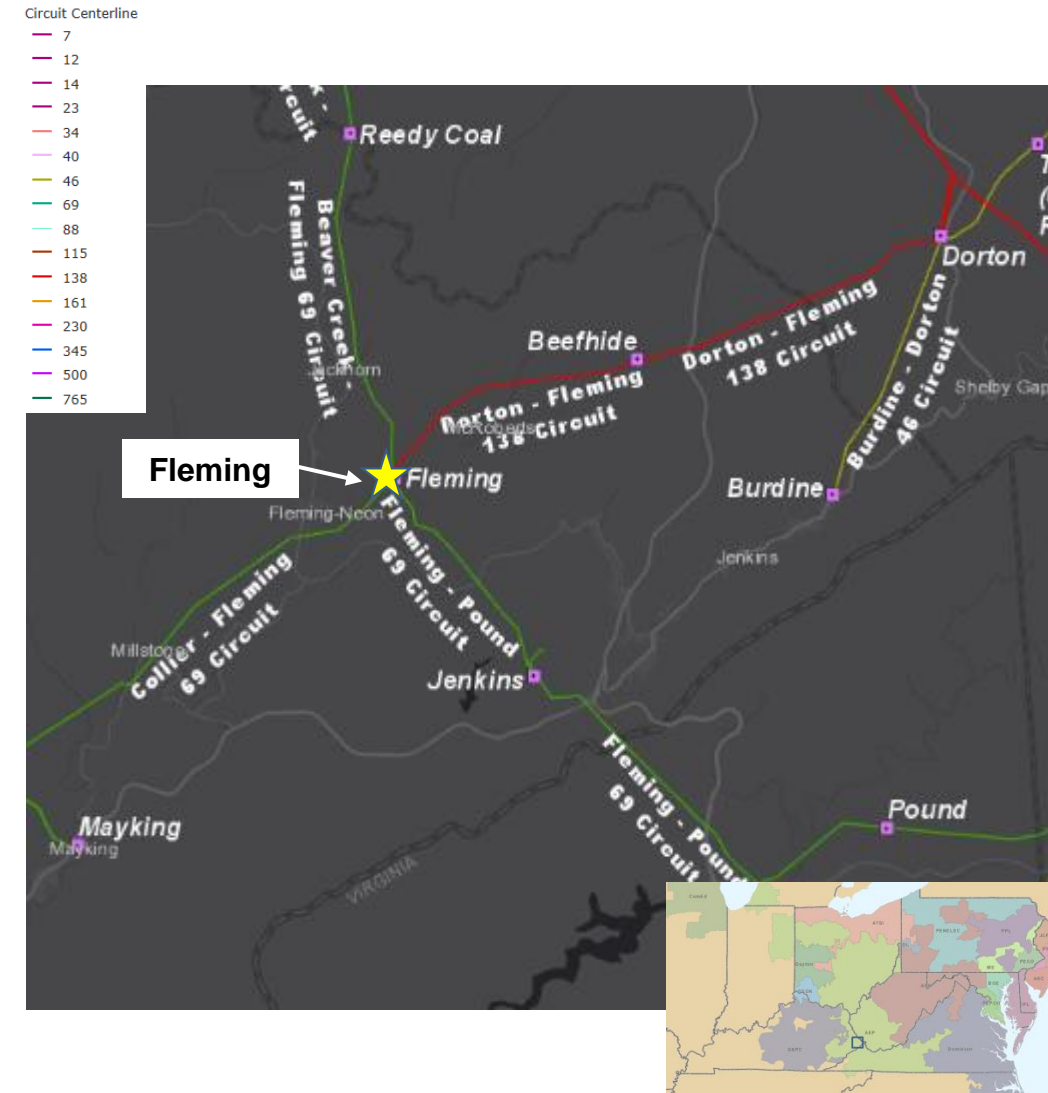

AEP Transmission Zone M-3 Process Fleming Station

Need Number: AEP-2019-AP007

Process Stage: Submission of Supplemental Project for inclusion in the Local Plan 05/11/2020

Selected Solution:

Fleming Substation (Supplemental):

- Rebuild Fleming station in the clear
- Replace 138/69kV Fleming Transformer #1 with 138/69kV 130 MVA transformer with high side 138 kV CB
- Install a 5 breaker 69 kV ring bus on the low side of the transformer, replace 69 kV circuit switcher AA, replace 69/12kV transformer #3 with 69/12kV 30 MVA transformer, Replace 12 kV CB A and D. Retire existing Fleming substation.
- **(S2219)**

Estimated Cost: \$21.1M

Projected In-Service: 09/01/2022

Supplemental Project ID: S2219

Project Status: Scoping

Model: N/A

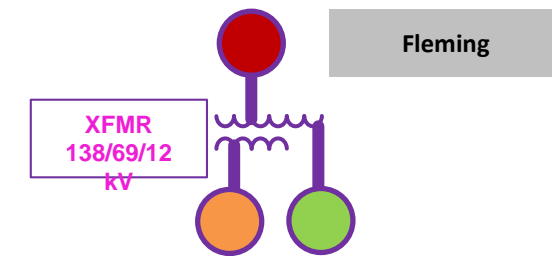

Legend	
345 kV	
138 kV	
69 kV	
46 kV	
New	

AEP Transmission Zone M-3 Process Speedway

Need Number: AEP-2019-AP018

Process Stage: Submission of Supplemental Project for inclusion in the Local Plan
05/11/2020

Previously Presented:

Needs Meeting 05/20/2019

Solutions Meeting 03/19/2020

Project Driver:

Equipment Material/ Condition/Performance/Risk, Operational Flexibility and Efficiency

Specific Assumption Reference:

AEP Guidelines for Transmission Owner Identified Needs (AEP Assumptions Slide 8)

Problem Statement:

Speedway 138 kV Tap

•There are 34 open conditions associated with the 1960s wood structures that comprise the 7.3 mile Speedway Tap that serves Speedway station. These conditions include damage due to woodpecker holes, damaged poles, and corroded cross-arms.

Glen Lyn –Hatcher 138 kV Line Section

•The Glen Lyn –Hatcher 138 kV line section utilizes double circuit lattice structures and conductor installed during the 1920s. The structures, conductor, hardware, and insulators on the line are displaying issues associated with their age.

Speedway Station

•Speedway station is currently radially served off the ~7.3 mile Speedway 138 kV Tap.

•Speedway station has 20 MW of nontransferable load (25 MW peak).

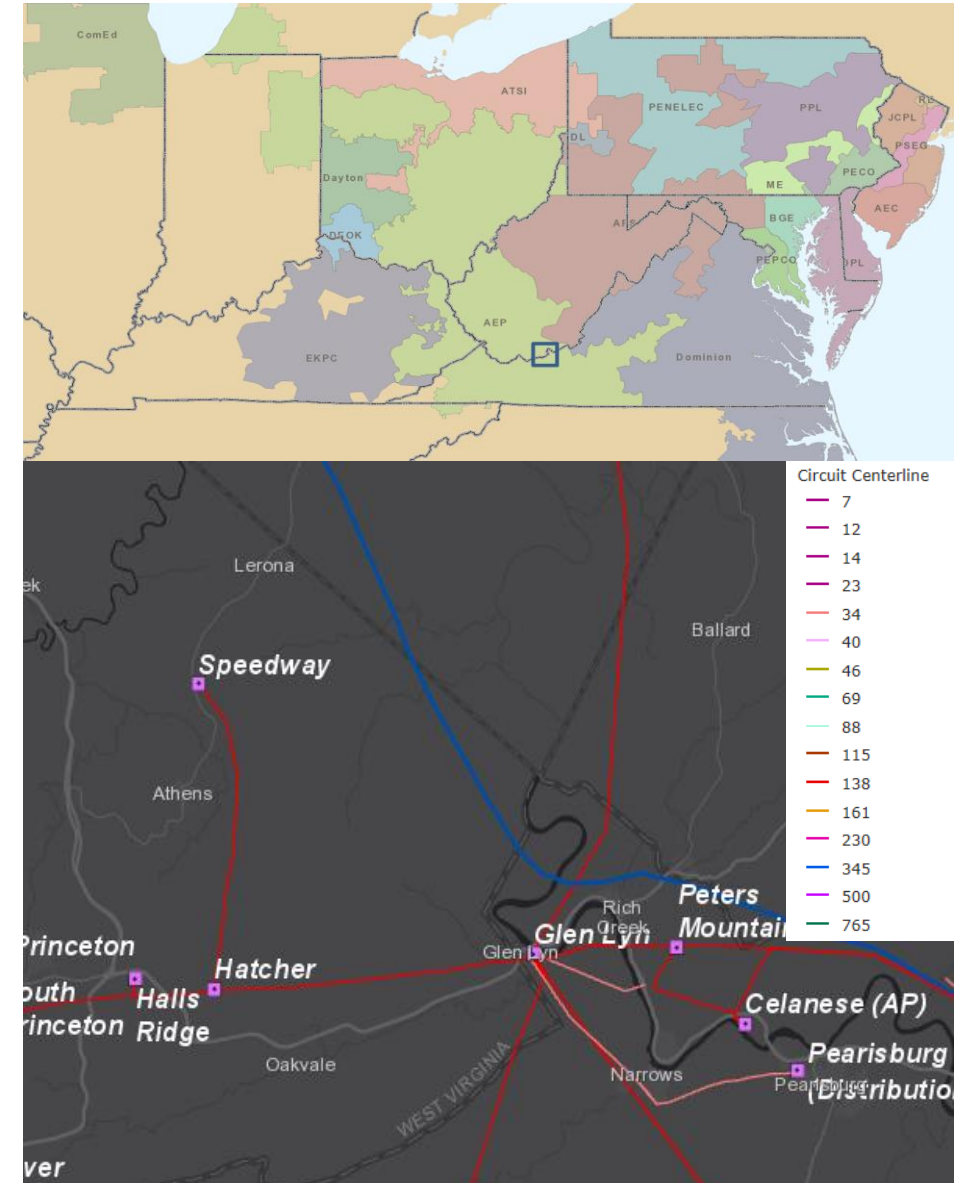

AEP Transmission Zone M-3 Process Speedway

Need Number: AEP-2019-AP018

Process Stage: Submission of Supplemental Project for inclusion in the Local Plan 05/11/2020

Selected Solution:

Phase 1:

Construct approximately 10 miles of new 138kV line between Glen Lyn and Speedway. New ROW will be required for the new Glen Lyn – Speedway 138kV line. Retire the existing section of line from Glen Lyn to Hatcher Switch (~ 8 miles), including Hatcher Switch.

(S2226.1) Estimated Cost: \$32.0M

Retire Hatcher Switch. Install MOABs at Speedway on new line to Glen Lyn and existing line towards South Princeton. Install a circuit switcher on the Speedway transformer.

(S2226.2) Estimated Cost: \$1.5M

Phase 2:

Rebuild ~7.3 miles of the Glen Lyn – South Princeton 138 KV circuit between Speedway station and the previous Hatcher Switch. **(S2226.3) Estimated Cost: \$21.9M**

Estimated Cost: \$55.4M

Projected In-Service: Phase 1: 5/1/2023

Projected In-Service: Phase 2: 12/1/2026

Supplemental Project ID: S2226.1-.3

Project Status: Scoping

Model: N/A

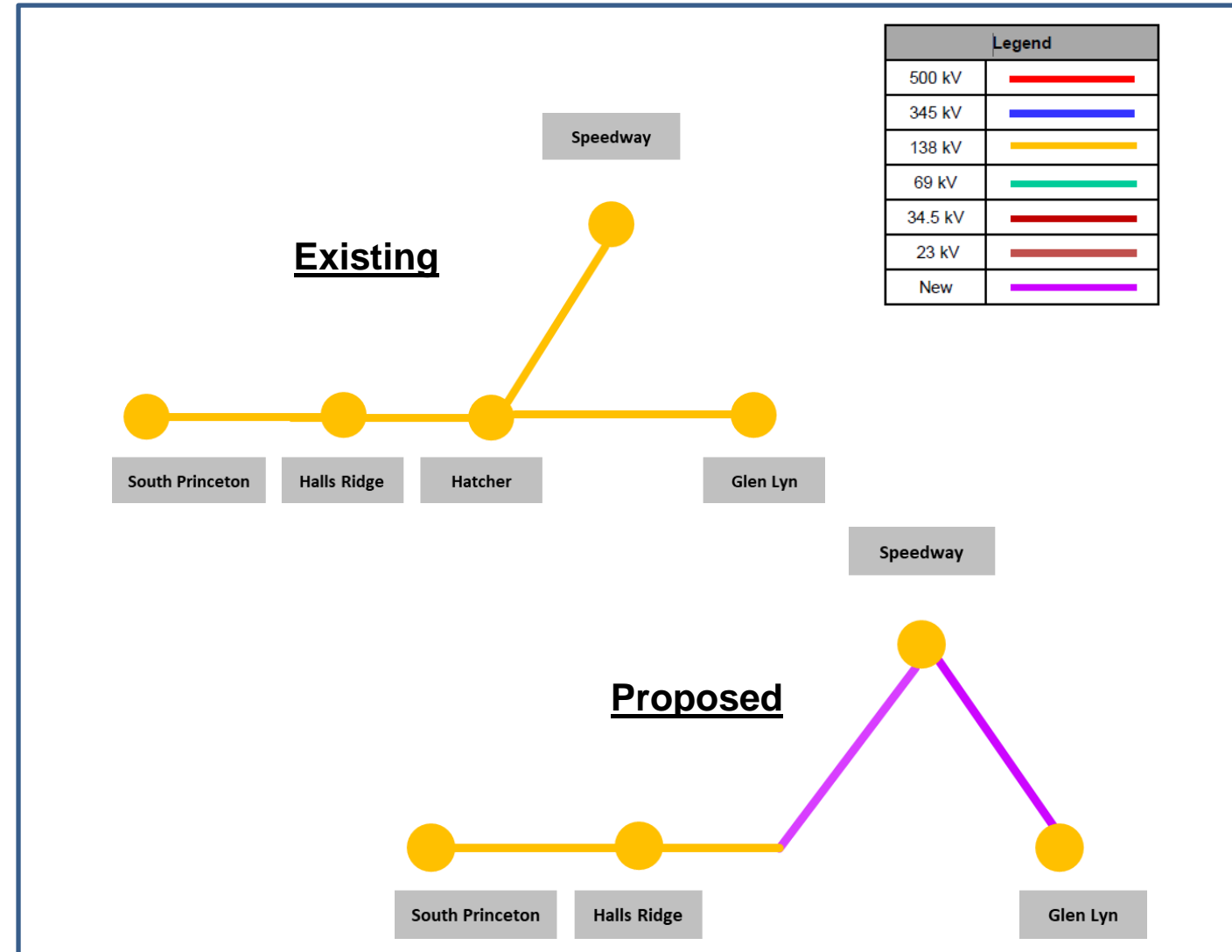

AEP Transmission Zone M-3 Process Cedar Creek Distribution

Need Number: ~~AEP-2020-AP022~~ AEP-2019-AP022

Process Stage: Submission of Supplemental Project for inclusion in the Local Plan 05/11/2020

Previously Presented:

Needs Meeting 5/20/2019

Solutions Meeting 3/19/2020

Project Driver:

Customer Service

Specific Assumption Reference:

AEP Connection Requirements for the AEP Transmission System (AEP Assumptions Slide 7)

Problem Statement:

- AEP Kentucky Power Distribution has requested a new distribution service out of the existing Cedar Creek Station located in Pikeville, Kentucky. Winter projected load is 12.5 MVA.

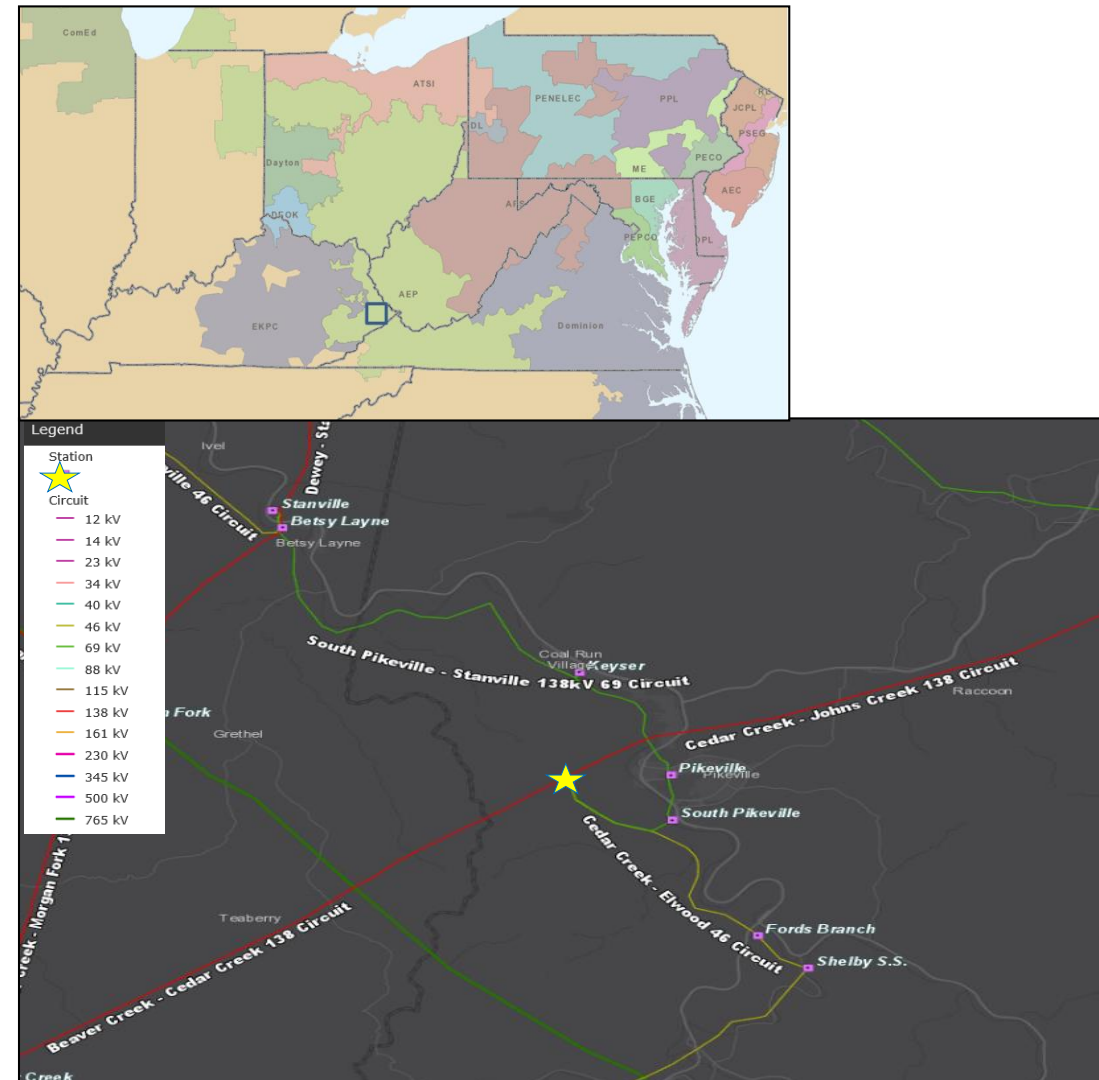

AEP Transmission Zone M-3 Process Cedar Creek Distribution

Need Number: AEP-2019-AP022

Process Stage: Submission of Supplemental Project for inclusion in the Local Plan 05/11/2020

Selected Solution:

Install 138/12 kV 25 MVA transformer on the Cedar Creek 138kV Bus #1 to serve the new load. (**S2220**)

Estimated Cost: \$3.5 M

Projected In-Service: 3/29/2020

Supplemental Project ID: S2220

Project Status: In Service (Customer Service)

Model: 2024 RTEP

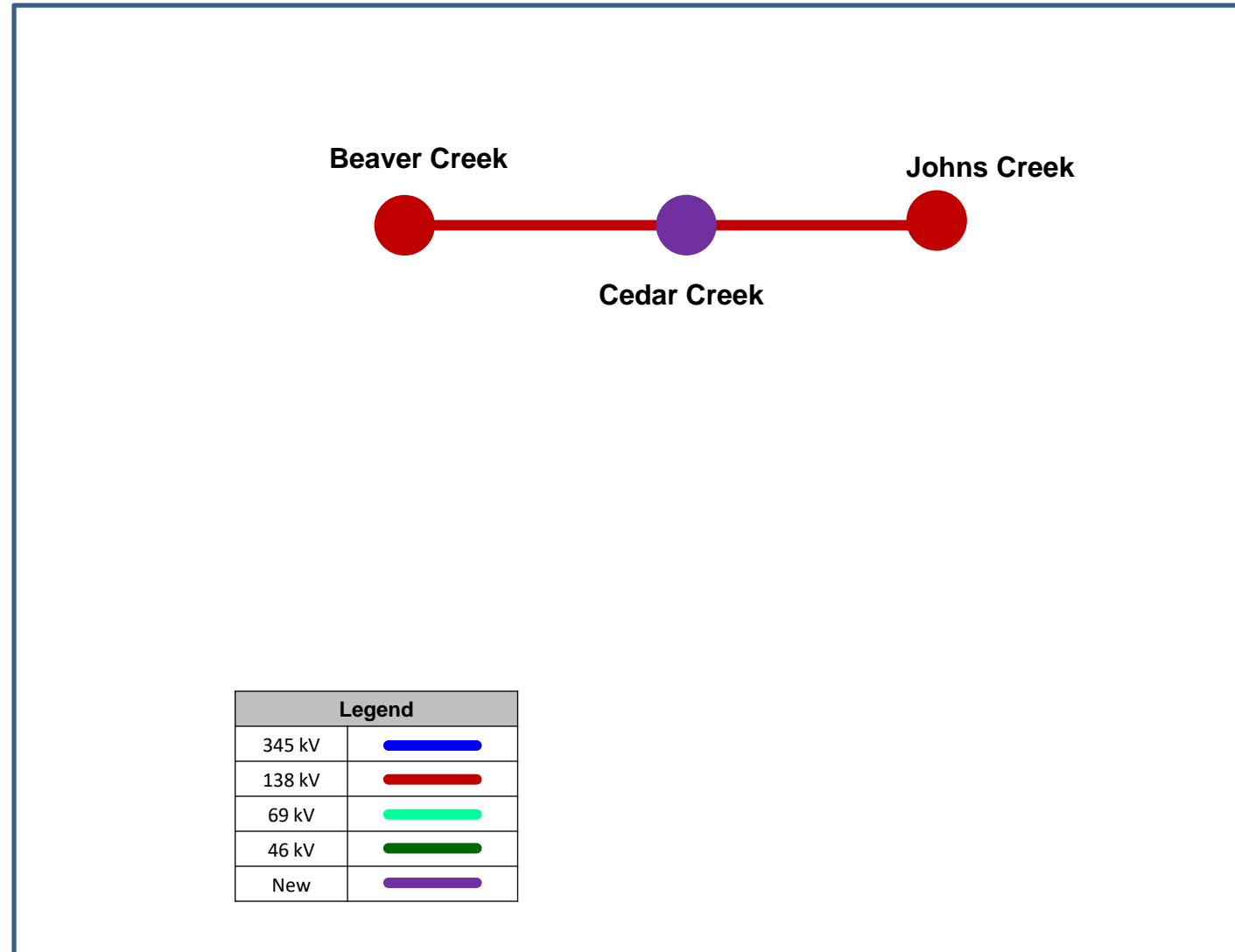

AEP Transmission Zone M-3 Process Hernshaw Area Project

Need Number: AEP-2019-AP015

Process Stage: Submission of Supplemental Project for inclusion in the Local Plan
05/11/2020

Previously Presented:

Needs Meeting 8/29/2019

Solutions Meeting 3/19/2020

Project Driver:

Equipment Material/Condition/Performance/Risk

Specific Assumption Reference:

AEP Guidelines for Transmission Owner Identified Needs (AEP Assumptions Slide 8)

Problem Statement:

- A customer station is currently served off a hard tap on the Belle – Cabin Creek – Marmet Hydro 46 kV circuit.
 - Hard taps are difficult to maintain due to required outages or temporary jumper configurations in lieu of a switch.
 - Hard taps can also result in extended outages to customers due to the inability to sectionalize faulted facilities.

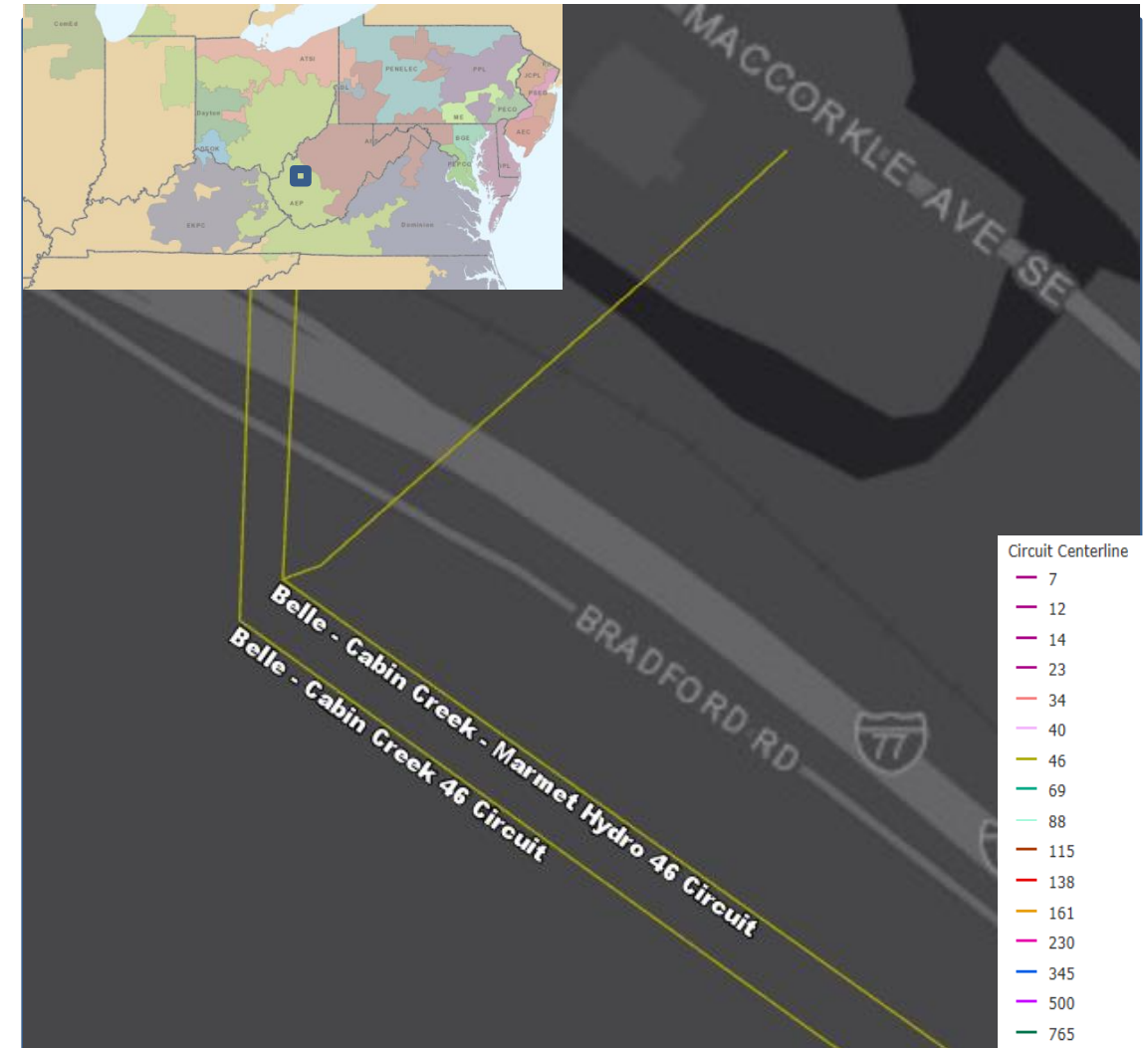

AEP Transmission Zone M-3 Process Hernshaw Area Project

Need Number: AEP-2019-AP027

Process Stage: Submission of Supplemental Project for inclusion in the Local Plan
05/11/2020

Previously Presented:

Needs Meeting 8/29/2019

Solutions Meeting 3/19/2020

Project Driver:

Equipment Material/Condition/Performance/Risk

Specific Assumption Reference:

AEP Guidelines for Transmission Owner Identified Needs (AEP Assumptions Slide 8)

Problem Statement:

Belle – Cabin Creek – Marmet Hydro 46 kV Circuit (7.58 miles)

- Majority of the circuit is constructed with 1930s lattice structures.
- Between 2015-2018 the circuit experienced 4 momentary and 3 permanent outage resulting in approximately 24k customer minutes of interruption
- There are currently 13 open conditions associated with the structures and hardware and include heavy rust, broken insulators and damaged shield wire hardware.
- The line does not comply with current NESC Standards.
- Most structures are situated on an extreme side hill, which also sits above the WV Turnpike which presents a significant danger/risk should the structures fail.
- This line parallels the Belle – Cabin Creek – Marmet line, need AEP-2019-AP028.

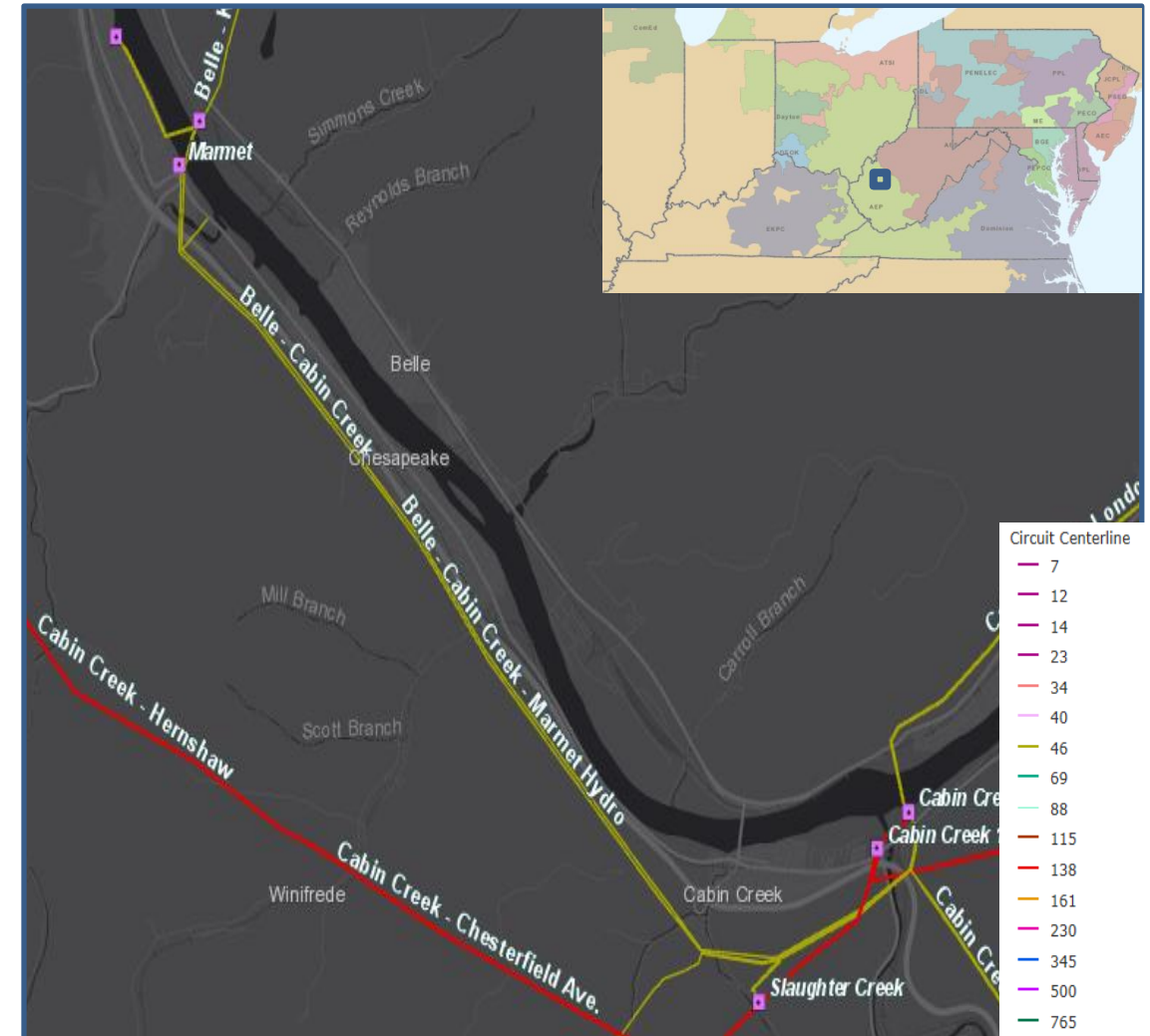

AEP Transmission Zone M-3 Process Hernshaw Area Project

Need Number: AEP-2019-AP028

Process Stage: Submission of Supplemental Project for inclusion in the Local Plan
05/11/2020

Previously Presented:

Needs Meeting 8/29/2019

Solutions Meeting 3/19/2020

Project Driver:

Equipment Material/Condition/Performance/Risk

Specific Assumption Reference:

AEP Guidelines for Transmission Owner Identified Needs (AEP Assumptions Slide 8)

Problem Statement:

Belle – Cabin Creek 46 kV Circuit (7.14 miles)

- Majority of the circuit is constructed with 1930s lattice structures.
- Between 2015-2018 the circuit experienced 6 momentary and 2 permanent outage resulting in approximately 242k customer minutes of interruption
- There are currently 13 open conditions associated with the structures and hardware and include heavy rust, broken insulators and corroded shield wire.
- The line does not comply with current NESC Standards
- Most structures are situated on an extreme side hill, which also sits above the WV Turnpike which presents a significant danger/risk should the structures fail.
- This line parallels the Belle – Cabin Creek – Marmet line, need AEP-2019-AP027.



AEP Transmission Zone M-3 Process Hernshaw Area Project

Need Number: AEP-2019-AP029

Process Stage: Submission of Supplemental Project for inclusion in the Local Plan
05/11/2020

Previously Presented:

Needs Meeting 8/29/2019

Solutions Meeting 3/19/2020

Project Driver:

Equipment Material/Condition/Performance/Risk

Specific Assumption Reference:

AEP Guidelines for Transmission Owner Identified Needs (AEP Assumptions Slide 8)

Problem Statement:

- Marmet Hydro is currently served off a hard tap on the Belle – Marmet Hydro – Cabin Creek 46 kV circuit
 - Hard taps are difficult to maintain due to required outages or temporary jumper configurations in lieu of a switch.
 - Hard taps result in extended outages to customers due to the inability to sectionalize faulted facilities.

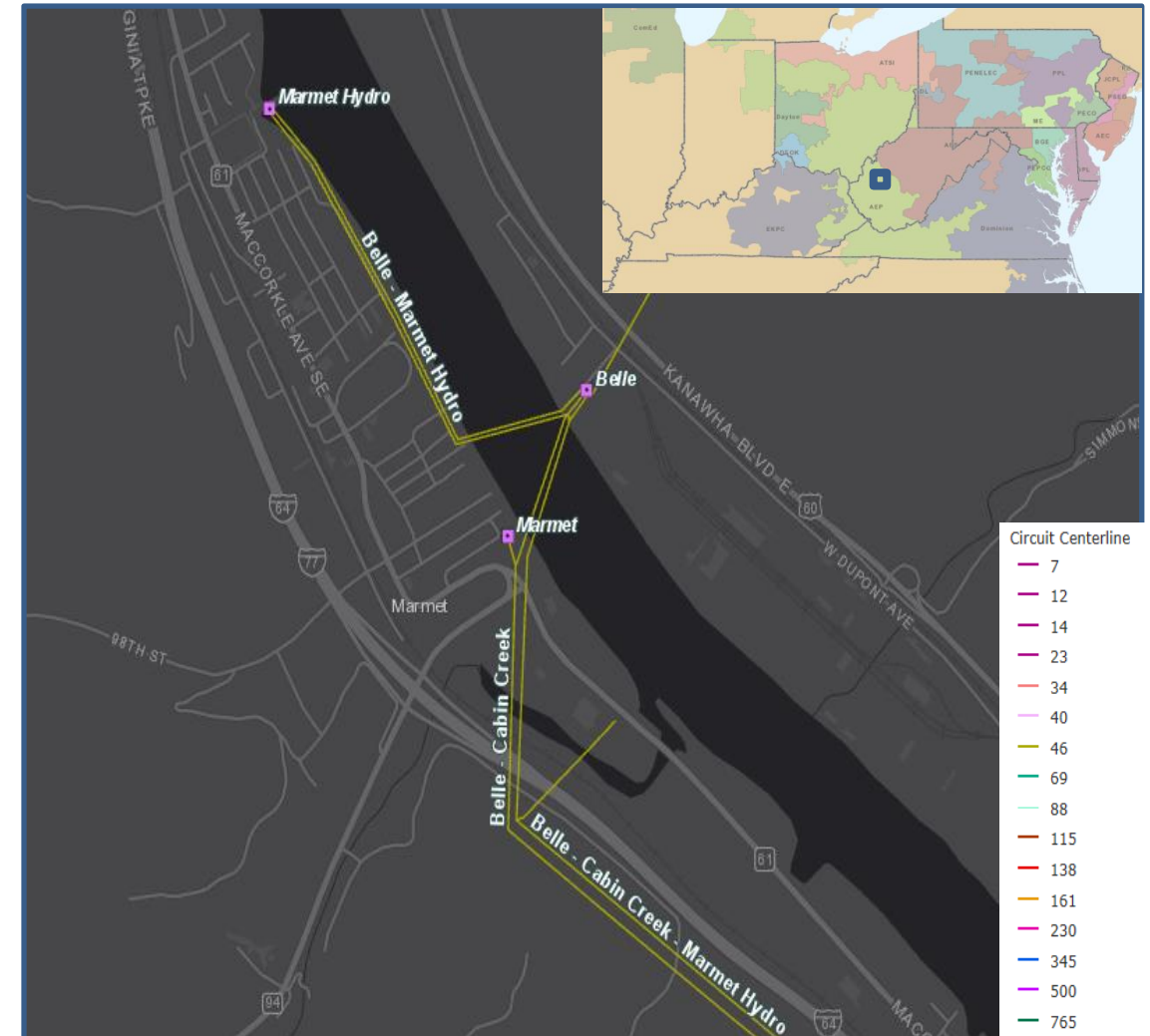

AEP Transmission Zone M-3 Process Hernshaw Area Project

Need Number: AEP-2019-AP015, AEP-2019-AP027, AEP-2019-AP028, AEP-2019-AP029

Process Stage: Submission of Supplemental Project for inclusion in the Local Plan 05/11/2020

Selected Solution:

Retire the existing 7.5-mile long Belle-Cabin Creek #1 and #2 circuits from Belle to Cabin Creek. **(S2225.1) Estimated Cost: \$10.0M**

Construct new double circuit 46kV line (designed to 138 kV) from Belle to Hernshaw (~4 miles). **(S2225.2) Estimated Cost: \$13.5M**

At Hernshaw Station, install 4 new 3000 A 40 kA 46 kV CBs (138 kV design) in a ring configuration. Install two new 138/46 kV 90 MVA transformers at Hernshaw with two 3000 A 40 kA 138 kV CBs on the high side of each new XFR. **(S2225.3) Estimated Cost: \$13.5M**

Remote end work and retire circuit breakers AA and AB at Cabin Creek station. **(S2225.4) Estimated Cost: \$0.8M**

Install Chesapeake 46 kV S.S. to eliminate existing hard tap currently serving Praxair. Install a new line extension to Praxair (0.2 miles). **(S2225.5) Estimated Cost: \$1.8M**

Replace the existing switches at Marmet Station to accommodate the new line construction. **(S2225.6) Estimated Cost: \$0.3M**

Marmet Hydro Hard Tap will be relocated to be positioned between 46 kV circuit breaker G at Belle and the new switches at Marmet Station. Remote end work required at Marmet Hydro Station. **(S2225.7) Estimated Cost: \$0.6M**

Belle Station work to replace CCVTs with new 46 kV PTs and upgrade line surge arresters. **(S2225.8) Estimated Cost: \$1.3M**

Ancillary Benefits: The extreme terrain on which the line sits presents numerous maintenance and access issues. This project moves the line away from the WV Turnpike and eliminates the access and maintenance concerns with the current location.

Estimated Cost: \$41.8 M

Projected In-Service: 4/1/2023

Supplemental Project ID: S2225.1-8

Project Status: Scoping

Model: N/A

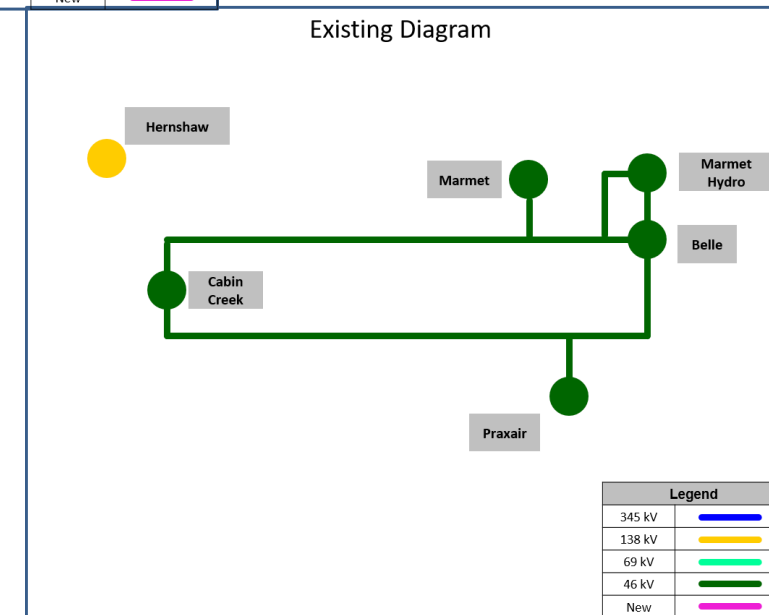
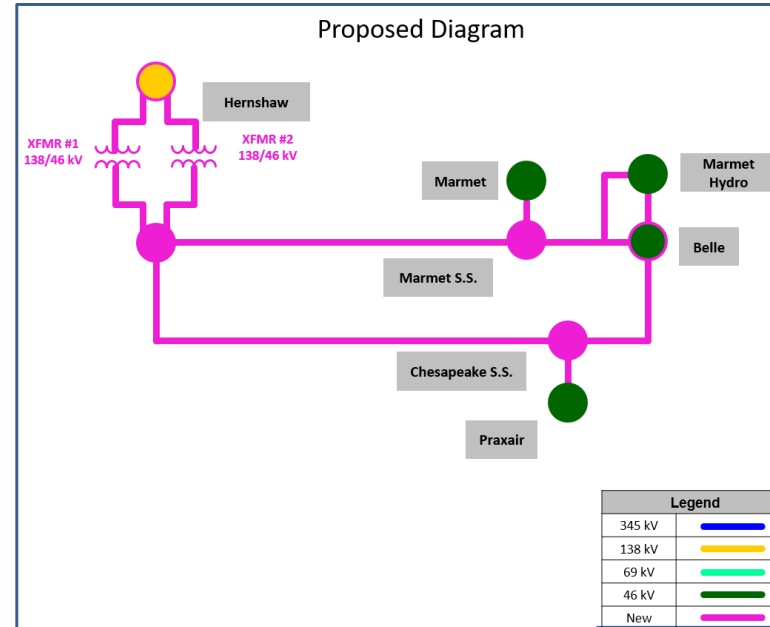

AEP Transmission Zone M-3 Process Sullivan Station Improvements

Need Number: AEP-2019-IM041

Process Stage: Submission of Supplemental Project for inclusion in the Local Plan 05/11/2020

Previously Presented:

Needs Meeting 10/25/2019

Solutions Meeting 3/10/2020

Project Driver:

Equipment Condition/Performance/Risk

Specific Assumption Reference:

AEP Guidelines for Transmission Owner Identified Needs (AEP Assumptions Slide 8)

Problem Statement:

Sullivan 765/345kV Station

765kV CB A2

- The Sullivan CB A2 is an ELF-SL8-4 Type SF6 breaker.
- As of September 2019 there are 9 of these breakers remaining in AEP's system including CB A at this station which just recently failed under AEP-2019-IM036.
- Since 2002, there have been 16 documented issues with the 9 remaining breakers dealing primarily with compressor failures and failure to open/reclose.

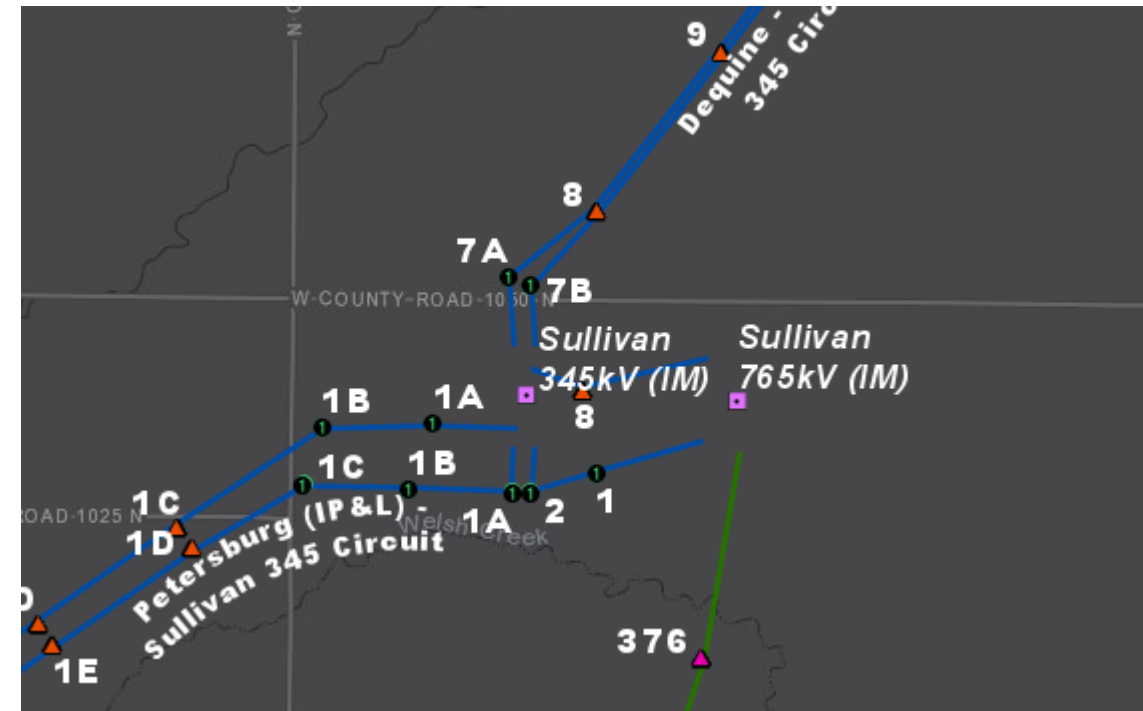

AEP Transmission Zone M-3 Process Sullivan Station Improvements

Need Number: AEP-2019-IM041

Process Stage: Submission of Supplemental Project for inclusion in the Local Plan 05/11/2020

Selected Solution:

Sullivan 765/345kV Station:

Replace Sullivan CB A2 765kV CB and associated equipment. (S2212)

Estimated Cost: \$7.1M

Projected In-Service: 2/1/2023

Supplemental Project ID: S2212

Project Status: Scoping

Model: N/A

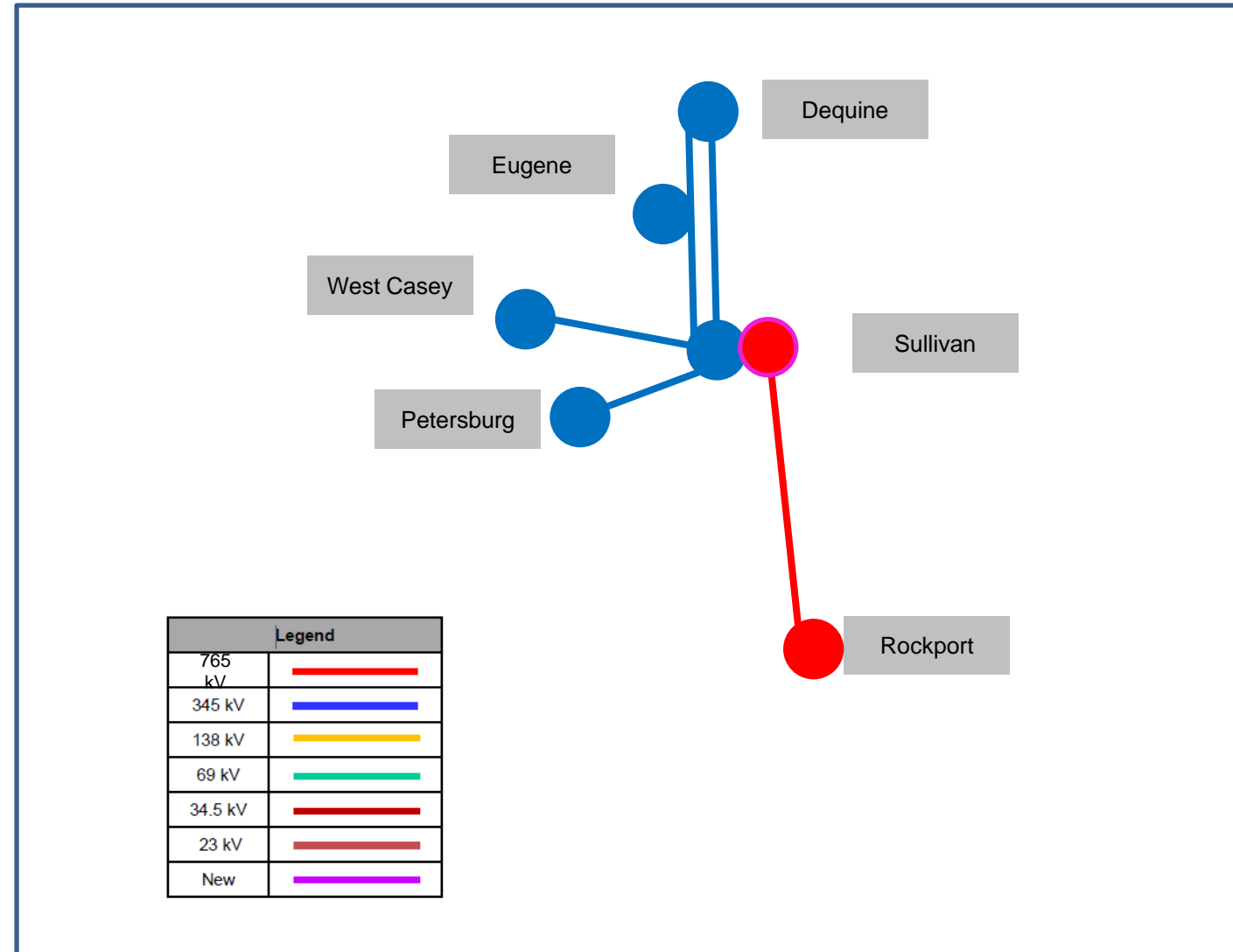

AEP Transmission Zone M-3 Process DOE X-350

Need Number: AEP-2018-OH003

Process Stage: Submission of Supplemental Project for inclusion in the Local Plan 05/11/2020

Previously Presented:

Needs Meeting 10/26/2018

Solutions Meeting 3/10/2020

Project Driver:

Customer Service

Specific Assumption Reference:

AEP Guidelines for Transmission Owner Identified Needs (AEP Assumptions Slide 8)

Problem Statement:

The Ohio Valley Electric Corporation (OVEC) and the US Department of Energy (DOE) are in the process of terminating their connection at Don Marquis. The DOE has informed AEP of its intention to retire its X-530 Substation, adjacent to AEP's Don Marquis Substation and has requested a new delivery point from AEP at the same location. The new load is anticipated to peak near 38MW.

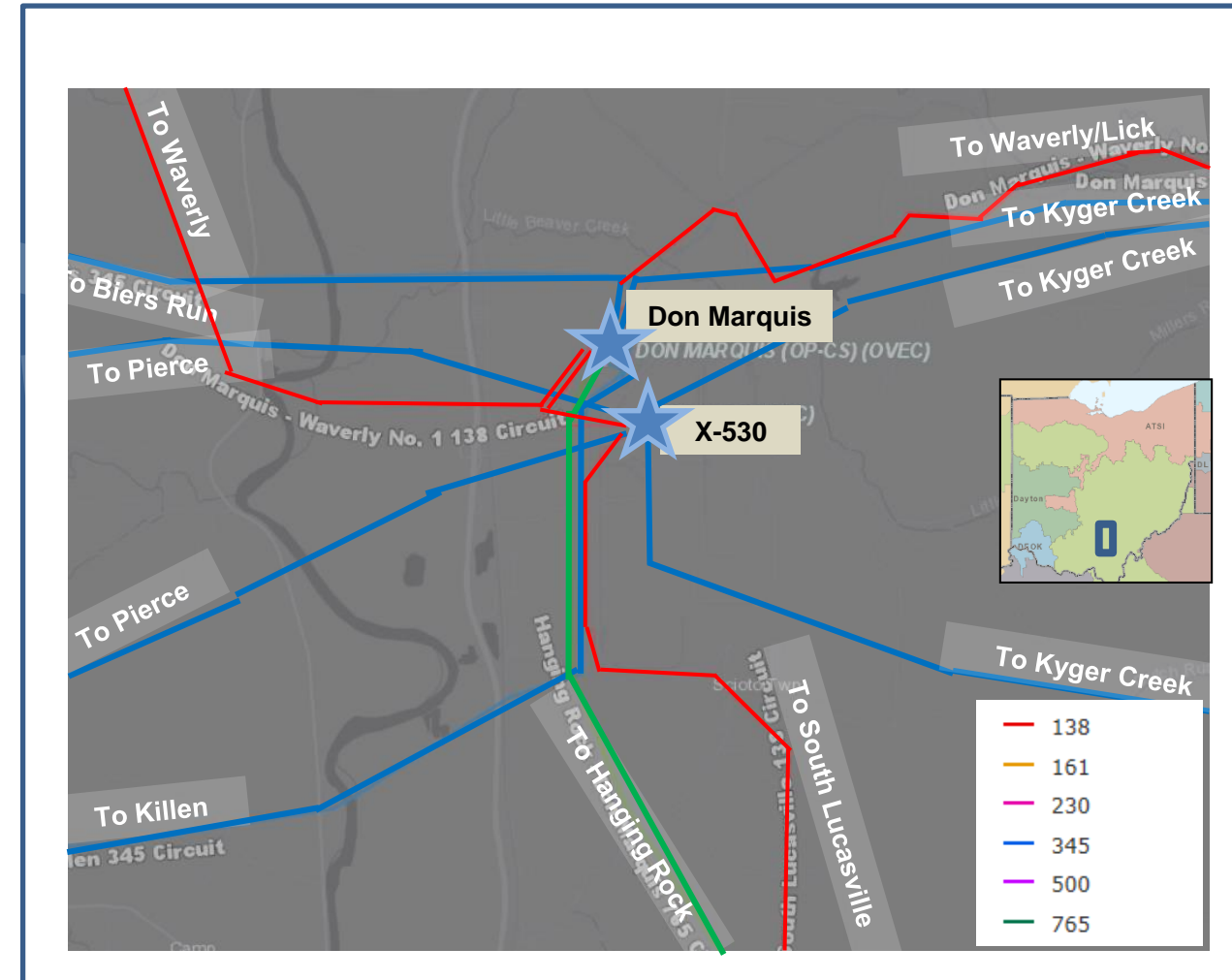

AEP Transmission Zone M-3 Process DOE X-350

Need Number: AEP-2018-OH003

Process Stage: Submission of Supplemental Project for inclusion in the Local Plan 05/11/2020

Selected Solution:

- Install a new transmission switching station (Arboles) to connect 138 kV lines to Don Marquis, Waverly, and Wakefield as well as four radial lines to serve the two new loads. The station will have 11 CBs (3000A, 40kA) in a breaker-and-a-half configuration. DOE requires 3 feeds and has requested 138 kV service. **(S2213.1) Estimated Cost: \$13.4M (AEP)**
- 6-wire the existing Don Marquis extension for 0.4-miles and rebuild 0.7 miles of the existing Marquis-Wakefield line as double circuit for two feeds from Waverly and Don Marquis. **(S2213.2) Estimated Cost: \$1.7M (AEP)**
- Construct ~0.3 miles of new line to terminate the South Lucasville circuit into Arboles. **(S2213.3) Estimated Cost: \$1.3M (AEP)**
- Construct two independent lines to serve the X-555 substation (DP #1). The lines will be ~0.4 miles long each. **(S2213.4) Estimated Cost: \$1.7M (AEP)**
- Construct two independent lines to serve the X-5001 substation (DP #2). The lines will be ~0.8 miles long each. **(S2213.5) Estimated Cost: \$3.5M (AEP)**

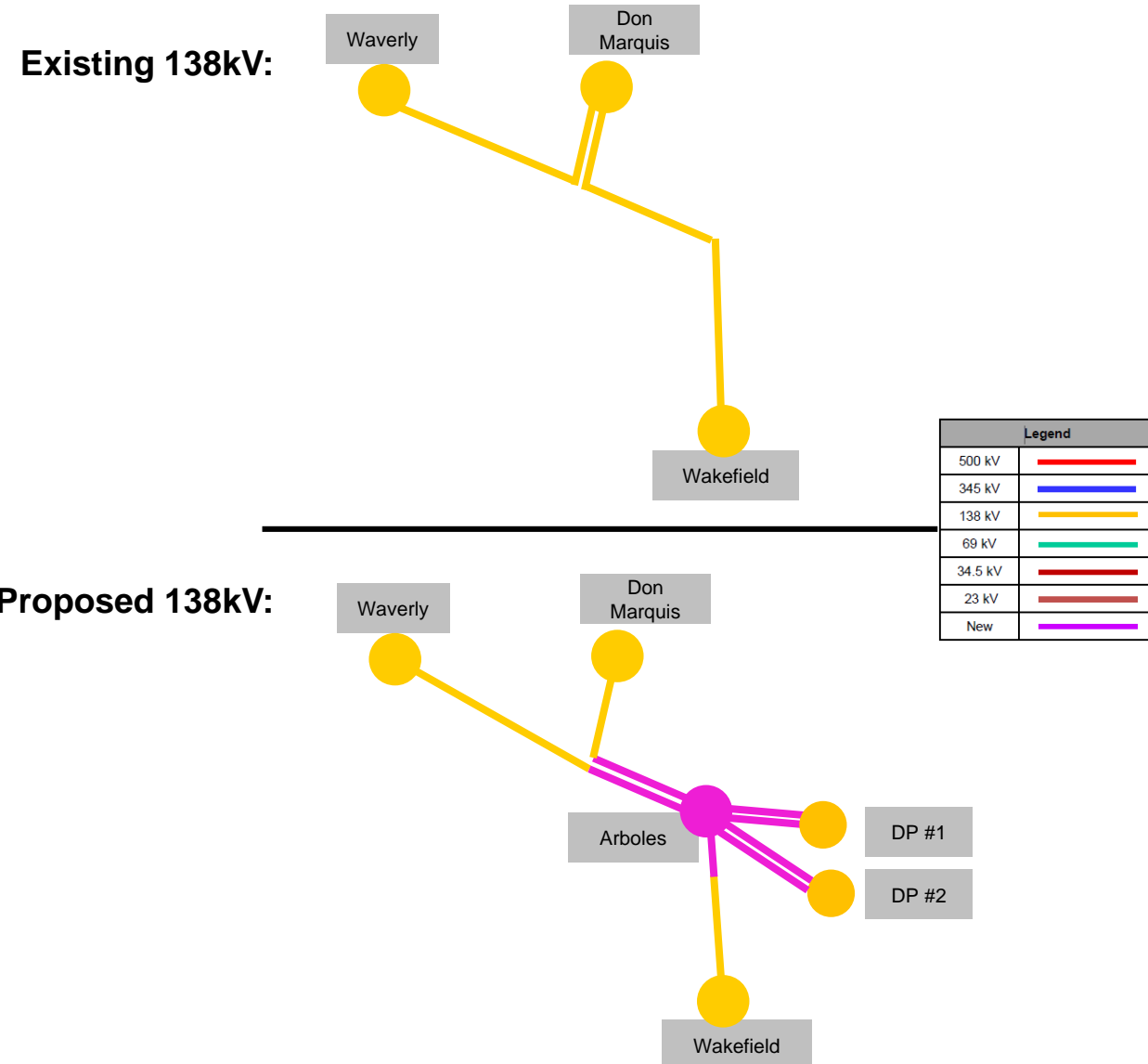

- At Don Marquis 345 kV, install 3-345kV 4000A 63kA circuit breakers to terminate the OVEC lines from Pierce and Kyger Creek. ~~Install intertie metering. -AEP side (S2213.6) Estimated Cost: \$8.8M (AEP), \$0.8M (OVEC)~~

- At Kyger Creek station, remove X-530 No.1 Exit and associated equipment. Update remote end relaying towards Don Marquis. (S2213.7) **Estimated Cost: \$1.1M (OVEC)**

- At Pierce station, remove X-530 No.1 Exit and associated equipment. Update the remote end relaying towards Don Marquis. (S2213.8) **Estimated Cost: \$0.8M (OVEC)**

- Six-wire 71.5 miles of the Pierce-Don Marquis line. Construct 0.13 miles of line to tie into Don Marquis station. (S2213.9) **Estimated Cost: \$0.8M (OVEC)**

- Six-wire 50.4 miles of the Kyger Creek-Don Marquis line. Construct 0.5 miles of line to tie into Don Marquis station. (S2213.10) **Estimated Cost: \$0.9M (OVEC)**

- At Don Marquis 345 kV, install 3-345kV 4000A 63kA circuit breakers to terminate the OVEC lines from Pierce and Kyger Creek. Install intertie metering. -OVEC side (S2213.11) **Estimated Cost: \$0.8M (OVEC)**

- ~~Install intertie metering at Don Marquis 345 kV station - OVEC side (S2213.11) Estimated Cost: \$0.8M (OVEC)~~

Total Cost AEP: \$30.4M

Total Cost OVEC: \$4.4M

Projected In-Service: 11/01/2021

Supplemental Project ID: S2213.1-.11

Project Status: Scoping

Model: N/A

AEP Transmission Zone M-3 Process DOE X-350

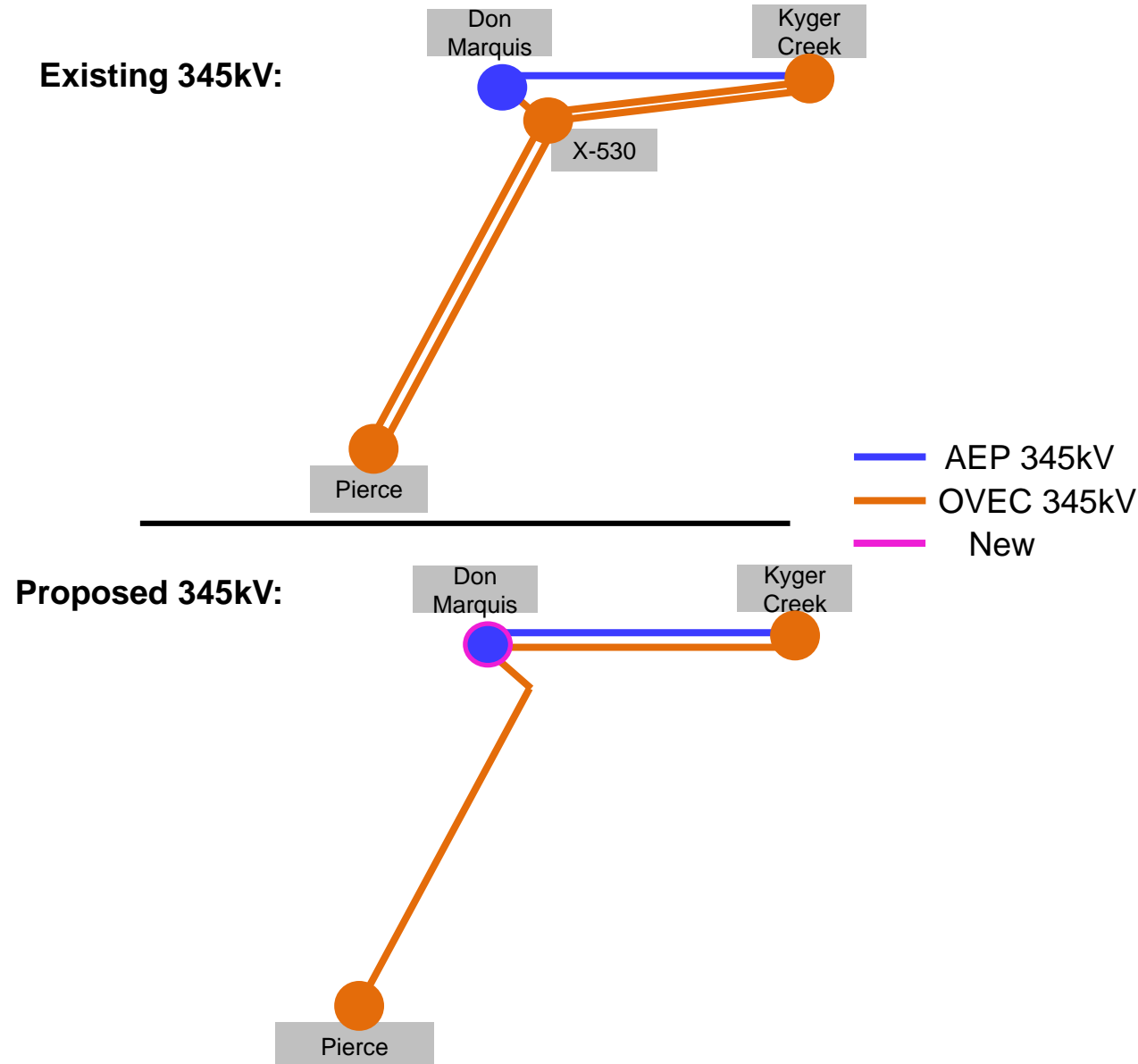

AEP Transmission Zone M-3 Process Roselms – Kalida 69kV

Need Number: AEP-2018-OH017

Process Stage: Submission of Supplemental Project for inclusion in the Local Plan 05/11/2020

Previously Presented:

Needs Meeting 10/26/2018

Solutions Meeting 03/19/2020

Project Driver:

Equipment Material/Condition/Performance/Risk and Customer Service

Specific Assumption Reference:

AEP Guidelines for Transmission Owner Identified Needs and AEP Connection Requirements for the AEP Transmission System

Problem Statement:

Continental – Roselms 69 kV is a 18 mi radial circuit serving ~10.6 MVA load. The customers served from this radial line have experienced 2.1 million customer minutes of interruptions over last 5 years. These radial loads are not automatically transferable. Any maintenance on this line results in outages to multiple stations.

Majority of the line has 4/0 ACSR conductor with a 2 mi section with 795 ACSR. This circuit has 89 open conditions. Most of the 258 structures on this circuit are 1960s and 1970s wood pole vintage with rotting issues.

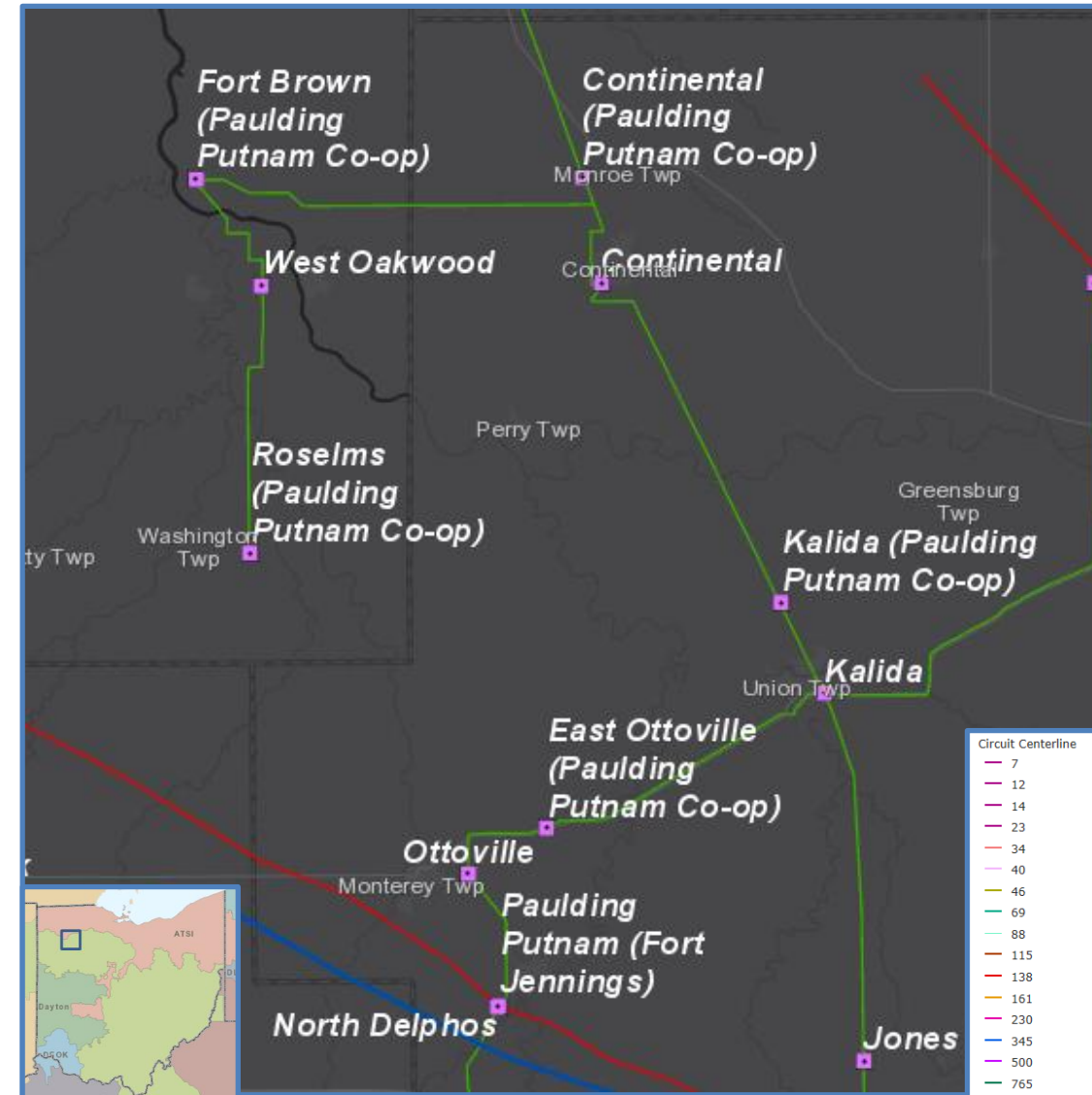

AEP Transmission Zone M-3 Process

Roselms – Kalida 69kV

Need Number: AEP-2019-OH059

Process Stage: Submission of Supplemental Project for inclusion in the Local Plan 05/11/2020

Previously Presented:

Needs Meeting 11/22/2019

Solutions Meeting 03/19/2020

Project Driver:

Equipment Material/Condition/Performance/Risk

Specific Assumption Reference:

AEP Guidelines for Transmission Owner Identified Needs

Problem Statement:

Kalida – North Delphos (Original 1914)

- Length: 11.26
- Original Construction Type: Wood
- Original Conductor Type: 4/0 Copper 7
- Momentary/Permanent Outages: 9 Momentary, 3 Permanent (5 year)
- CMI: 206,131 (5 year)
- Total structure count: 268
- Number of open conditions: 58
 - Open conditions include: rot heart, insect damage, broken/missing ground leads, burnt insulators
- Unique structure count with open conditions: 50

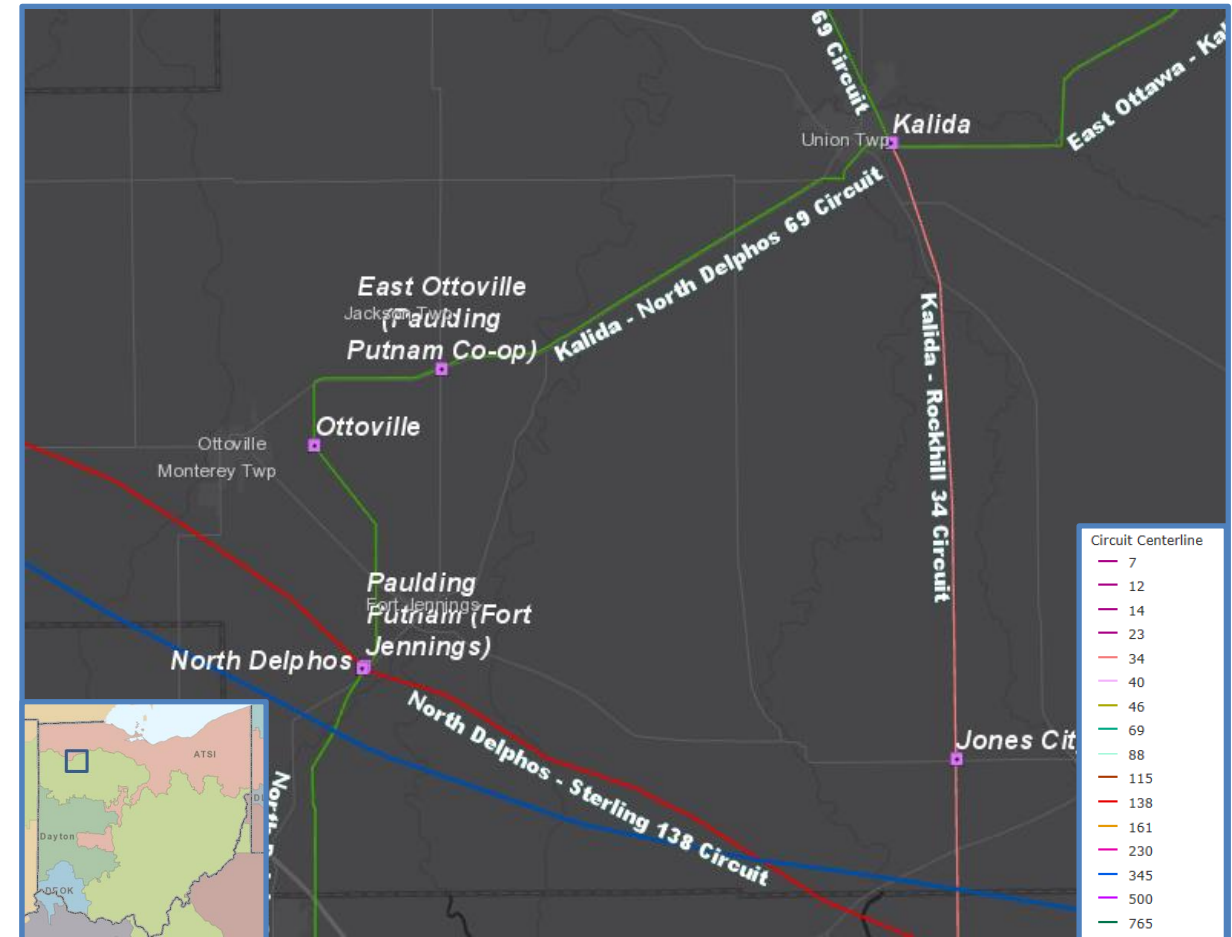

AEP Transmission Zone M-3 Process Roselms – Kalida 69kV

Need Number: AEP-2018-OH017 & AEP-2019-OH059

Process Stage: Submission of Supplemental Project for inclusion in the Local Plan 05/11/2020

Selected Solution:

- Rebuild 16 miles of 69 kV single circuit line from North Continental Switch (existing switch to be retired) to Roselms Switch (located next to the existing Roselms- PP Co-op Station). **(S2215.1) Estimated Cost: \$38.4M**
- Build 9.4 miles of single circuit 69 kV line from Roselms to near East Ottoville 69 kV Switch. **(S2215.2) Estimated Cost: \$13.7M**
- Rebuild 7.5 miles of double circuit 69kV line between East Ottoville Switch and Kalida Station (combining with the new Roselms to Kalida 69 kV circuit). **(S2215.3) Estimated Cost: \$23.6M**
- Rebuild 5.1 miles of single circuit 69 kV line from East Ottoville to North Delphos. **(S2215.4) Estimated Cost: \$9.4M**
- At North Continental, remove normally open bypass switch. **(S2215.5) Estimated Cost: \$0.1M**
- At Fort Brown Switch, install a three way 69kV, 1200 A phase-over-phase switch, with sectionalizing capability. **(S2215.6) Estimated Cost: \$0.7M**

Existing Configuration:

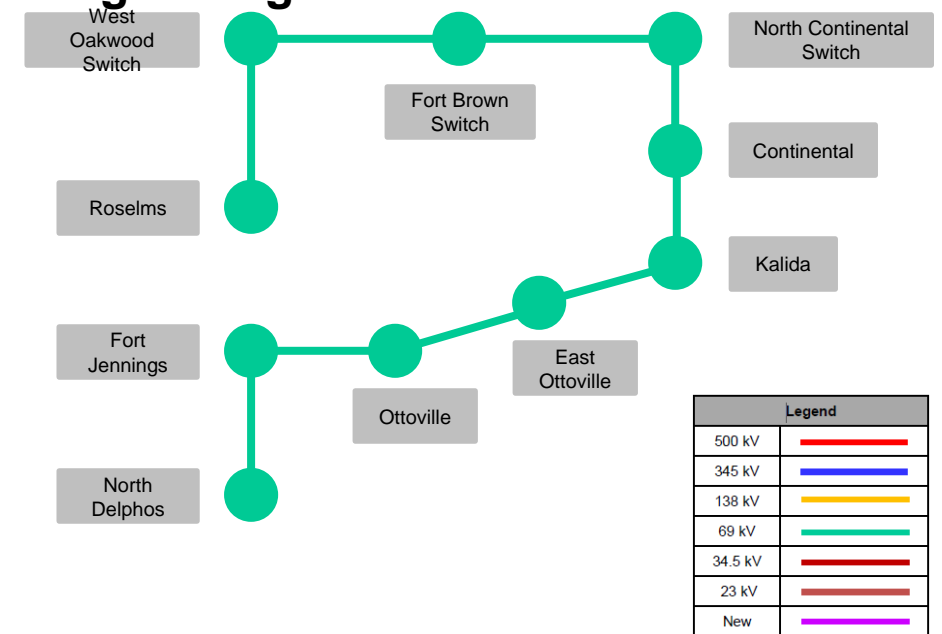

Proposed Configuration:

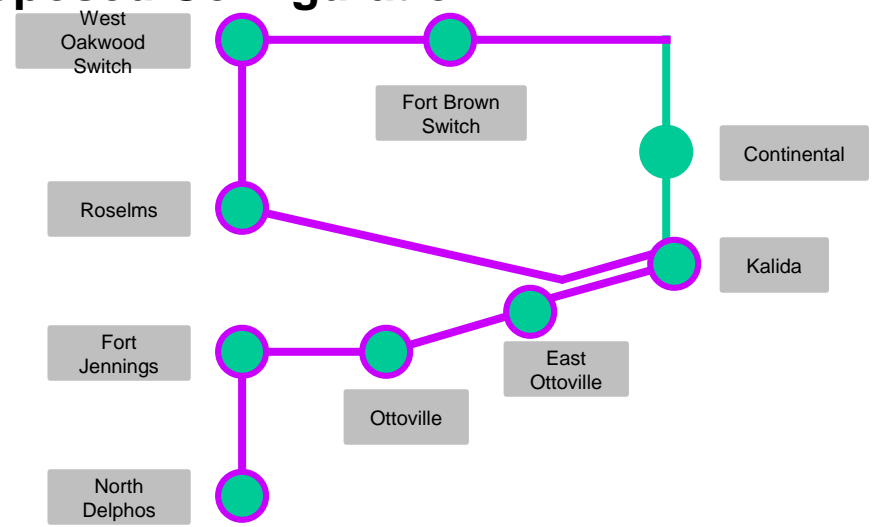

AEP Transmission Zone M-3 Process Roselms – Kalida 69kV

- At West Oakwood Switch, install a three way 69kV, 1200 A phase-over-phase switch, with sectionalizing capability. **(S2215.7) Estimated Cost: \$0.6M**
- At Roselms Switch, install a new three way 69kV, 1200 A phase-over-phase switch, with sectionalizing capability. **(S2215.8) Estimated Cost: \$0.6M**
- At Kalida station, move CB J from low side of Transformer 2 to terminate the new line from Roselms Switch. Move the CS XT2 from high side of T2 to the high side of T1. Remove existing T2 transformer. **(S2215.9) Estimated Cost: \$1.0M**
- Remote end work at North Delphos station. **(S2215.10) Estimated Cost: \$0.8M**
- At East Ottoville, install a three way 69kV, 1200 A phase-over-phase switch, with sectionalizing capability. **(S2215.11) Estimated Cost: \$0.7M**
- At Ottoville station, install 2- three way 69 kV, 1200 A, phase over phase Switches, with sectionalizing capability. **(S2215.12) Estimated Cost: \$1.9M**
- At Fort Jennings, replace hard tap with a three way 69kV, 1200 A phase-over-phase switch, with sectionalizing capability. **(S2215.13) Estimated Cost: \$0.6M**

Estimated Cost: \$92.1M

Projected In-Service: 8/15/2022

Supplemental Project ID: S2215.1-.13

Project Status: Engineering

Model: 2024 Summer RTEP

Existing Configuration:

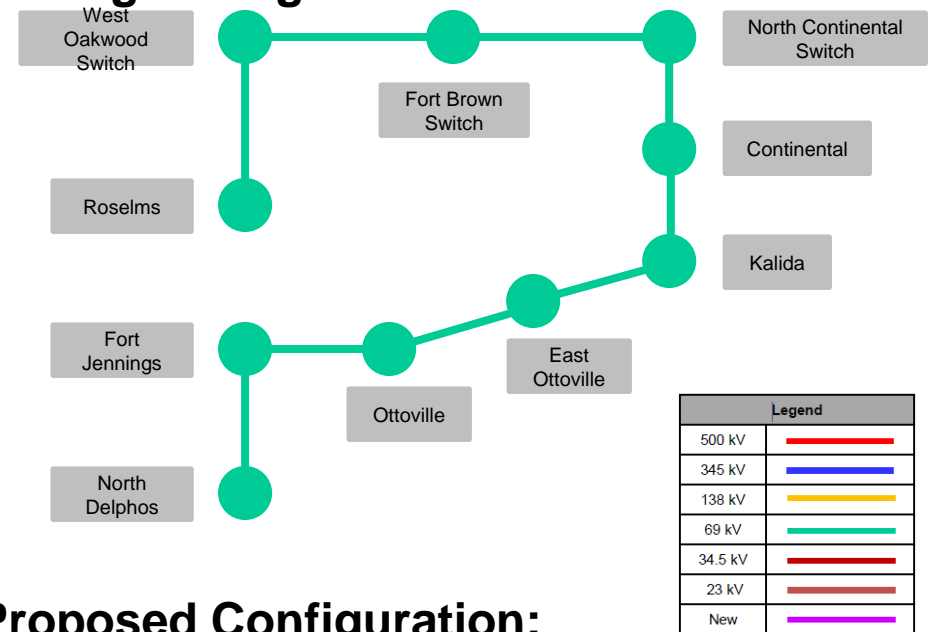

Proposed Configuration:

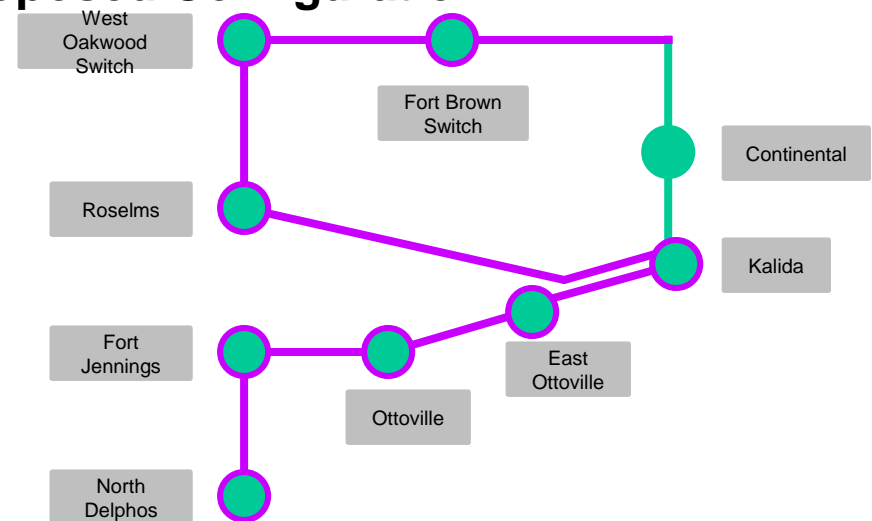

AEP Transmission Zone M-3 Process Athens Area Improvements

Need Number: AEP-2018-OH027

Process Stage: Submission of Supplemental Project for inclusion in the Local Plan 05/11/2020

Previously Presented:

Needs Meeting 11/29/2018

Solutions Meeting 3/19/2020

Project Driver:

Equipment Material/Condition/Performance/Risk, Operational Flexibility and Efficiency

Specific Assumption Reference:

AEP Guidelines for Transmission Owner Identified Needs (slide 8)

Problem Statement:

Equipment Material / Condition / Performance / Risk:

- Elliott 138 kV circuit breaker 102 (vintage 1956) is an oil type breaker recommended for replacement due to bushing damage, reliability, and lack of spare part availability.
- Elliot 69kV circuit breakers 61, 66, and 67 (vintage 1972) have experienced the following numbers of fault operations: CB-102 (38), CB-67 (10), CB-66 (40), and CB-61 (1). These breakers are oil type breakers recommended for replacement due to reliability and lack of spare part availability.
- Strouds Run 69kV circuit breakers 63 and 66 (vintage 1969-1973) are oil breakers recommended to replace due to reliability and lack of spare part availability. Maintenance has become more difficult due to the oil handling required to maintain them. They have experienced the following fault operations: CB 63 (24), CB 66 (0).
- Strouds Run 138kV Circuit switchers “CS-TR1” and “CS-TR2” are Mark type switchers. Mark switchers are being recommended for replacement system wide due to their inability to coordinate with modern relaying packages. Circuit switchers have experienced the following fault operations: CS-TR1 (17), CS-TR2 (18).
- Strouds Run 138/69 kV 33.6MVA transformer #1 (vintage 1972) is also showing significant signs of deterioration. Drivers for replacement include dielectric strength breakdown, short circuit strength breakdown, and bushing damage.
- Clark Street 69 kV circuit breakers 61 and 64 (vintage 1968) are oil filled breakers that have been recommended for replacement due to oil handling requirements, no longer has vendor support, lacks sufficient spare part availability, and has a history of malfunctions. The breakers have had the following fault operations: CB 61 (8) and CB 64 (15).

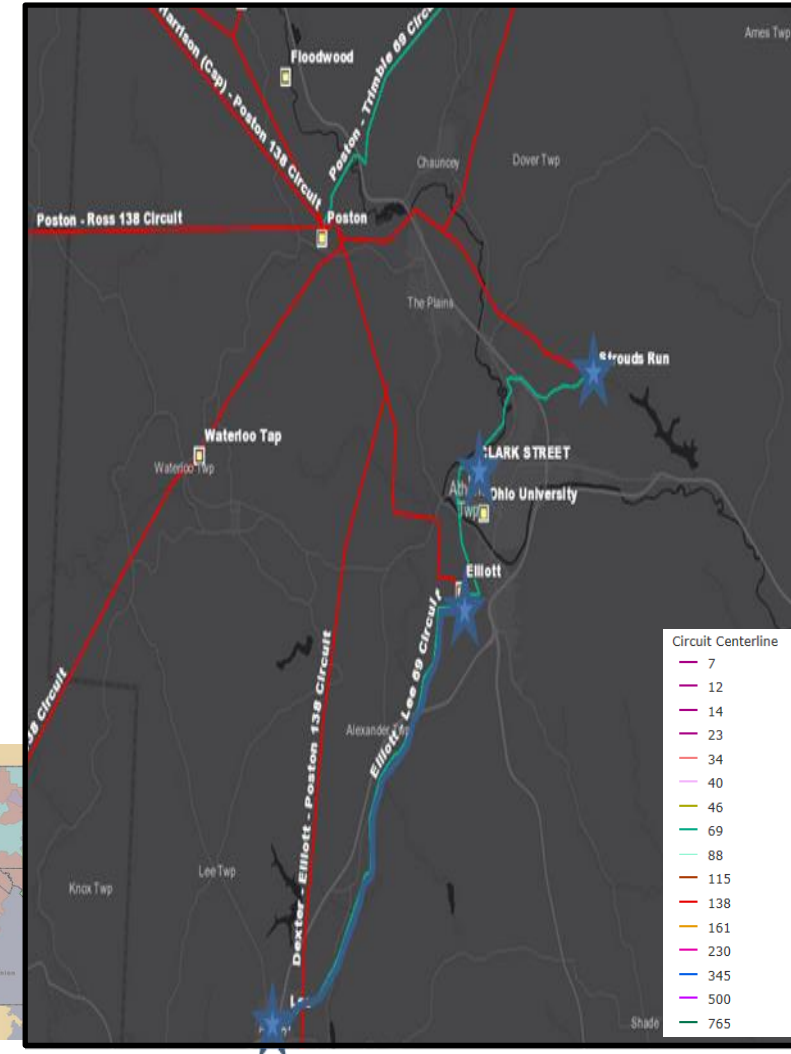
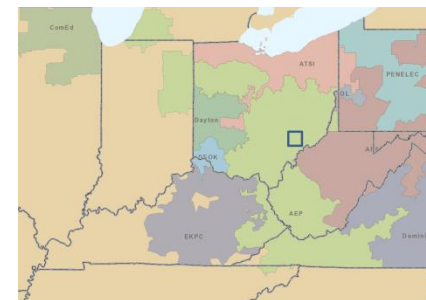

AEP Transmission Zone M-3 Process Athens Area Improvements

Problem Statement Continued:

Equipment Material / Condition / Performance / Risk:

- The Elliot – Lee 69kV 8 mile, 69 kV line (vintage 1974) was constructed using wood pole structures with 336.4 KCM ACSR 18/1 conductor (73 MVA rating).
- There are 106 open A conditions on this line, including rotten structures, burnt/broken insulators, and loose/broken/sagging conductor sections, improperly installed shield wires and woodpecker damaged structures.
- These stations still have the following amount of electromechanical relays employed: Elliot (29), Strouds Run (78), Clark Street (25). EM relays have limited vendor support, lack SCADA functionality, and don't offer fault data collection.

Operational Flexibility and Efficiency:

- The Crooksville – Poston – Strouds Run 138kV circuit is a three-terminal line, which limits sectionalizing and can cause mis-operations and over tripping.
- The Dexter – Elliott – Poston 138kV circuit is a three-terminal line, which limits sectionalizing and can cause mis-operations and over tripping

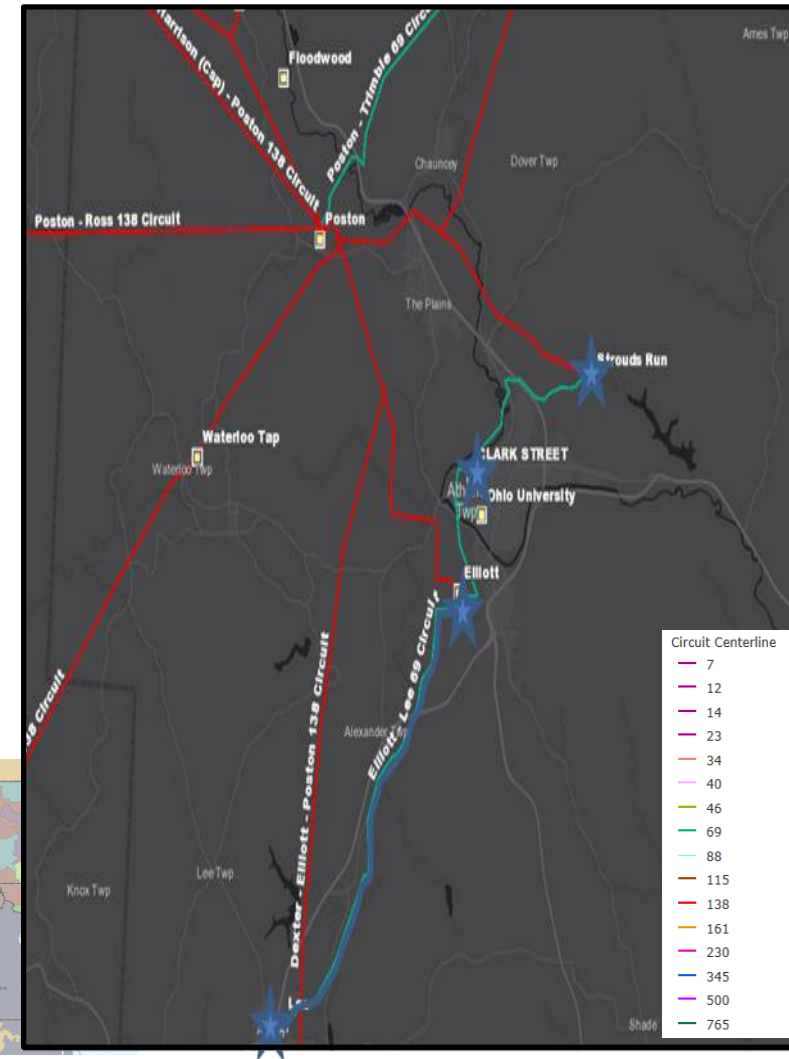
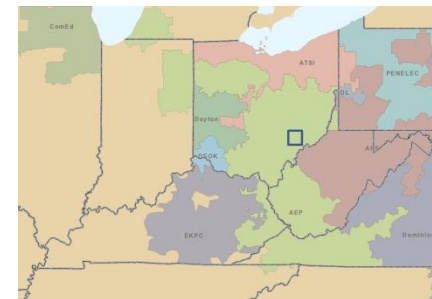

AEP Transmission Zone M-3 Process Athens Area Improvements

Need Number: AEP-2020-OH011

Process Stage: Submission of Supplemental Project for inclusion in the Local Plan 05/11/2020

Previously Presented:

Needs Meeting 2/21/2020

Solutions Meeting 3/19/2020

Project Driver:

Equipment Material/Condition/Performance/Risk

Specific Assumption Reference:

AEP Guidelines for Transmission Owner Identified Needs (AEP Assumptions Slide 8), AEP Presentation on Pre-1930s Lines

Problem Statement:

Dexter –Rosewood 138kV (1927 Steel Lattice Line)

- Length: 8.8 Miles
- Original Construction Type: Aluminum/Steel Lattice
- Original Conductor Type: 397.5 CM ACSR 30/7 (1926 vintage)
- Momentary/Permanent Outages: 3 total outages over last 5 years
- Total structure count: 38
- Please reference needs materials on pre-1930s era lattice lines
- There is an additional 2.5 miles of the 1920’s Philo -Rutland lattice line which is de-energized and runs through the middle of The Plains community north of Athens

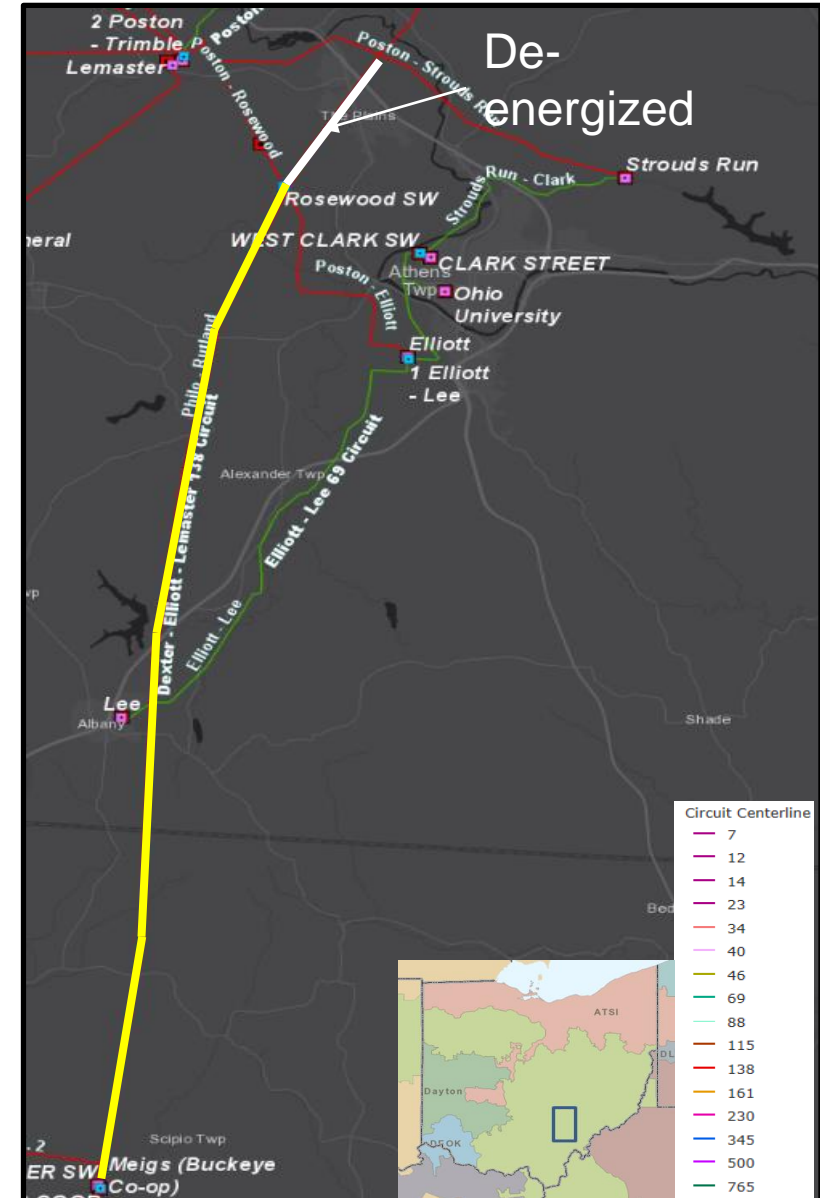

AEP Transmission Zone M-3 Process Athens Area Improvements

Need Number: AEP-2020-OH014

Process Stage: Submission of Supplemental Project for inclusion in the Local Plan 05/11/2020

Previously Presented:

Needs Meeting 02/21/2020

Solutions Meeting 3/19/2020

Project Driver:

Equipment Material/Condition/Performance/Risk

Specific Assumption Reference:

AEP Guidelines for Transmission Owner Identified Needs (AEP Assumptions slide 8)

Problem Statement:

Poston – Strouds Run 138kV (1965)

- Length 7.52 Miles
- Original Construction Type: Wood H-Frame
- Original Conductor Type: 636 ACSR Conductor (vintage 1966)
- Momentary/Permanent Outages: 3 total outages last 5 years
 - Number of open conditions: 62
 - Total structure count: 46
 - Open conditions include: rot top, woodpecker holes, bowed structures, and burnt poles
 - Unique structure count with open conditions: 31



AEP Transmission Zone M-3 Process Athens Area Improvements

Need Number: AEP-2018-OH027, AEP-2020-OH011 & AEP-2020-OH014

Process Stage: Submission of Supplemental Project for inclusion in the Local Plan 05/11/2020

Selected Solution:

- Rebuild the existing ~8 mile Elliott – Lee 69kV line to 138 kV and retire the existing 69 kV line. **(S2224.1) Estimated Cost: \$20.7M**
- Retire approximately 11.5 miles of the Philo – Rutland 138kV line asset from Lee station north, including the de-energized portion of the line that runs through the Plains community. **(S2224.2) Estimated Cost: \$3.5M**
- Convert Lee to 138 kV service and install two line MOABs connected to the 138 kV line between Dexter and Elliot. **(S2224.3) Estimated Cost: \$3.0M**
- At Clark Street, replace 69 kV circuit breakers “61” & “64” (3000A 40kA). **(S2224.4) Estimated Cost: \$2.9M**
- At Elliot, install a new 138/69 kV transformer (130 MVA) in addition to high and low side protection (3000 A 40 kA) which will replace transformer #1 at Strouds Run that will be retired. Replace existing 138 kV circuit breaker “102” and 69 kV circuit breakers “61” and “66” (3000A, 40 kA). Install 138 kV circuit breaker (3000A, 40 kA) on the new 138 kV line towards Dexter (via Lee) along with a 138 kV bus-tie breaker (3000, 40 kA). Retire 69 kV circuit breaker “67” due to the conversion of Lee station to 138 kV. **(S2224.5) Estimated Cost: \$6.7M**
- Rebuild ~3.68 miles of single circuit line from the Poston - Strouds Run line as double circuit 138kV transmission line to eliminate the hard tap on the line. **(S2224.6) Estimated Cost: \$16.0M**

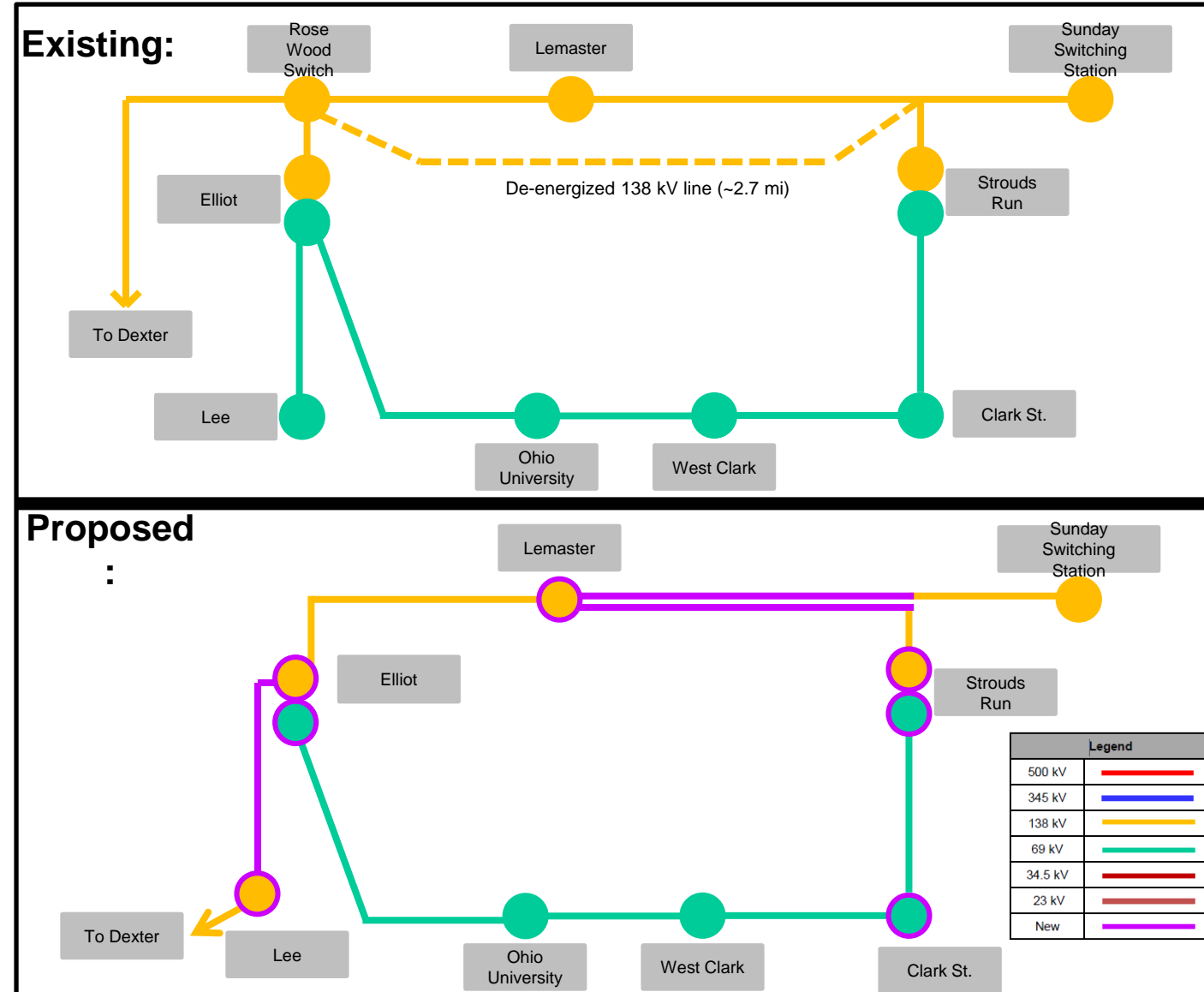

AEP Transmission Zone M-3 Process Athens Area Improvements

Selected Solution Continued:

- At Strouds Run, install a 138kV line breaker (3000A 40kA) towards Lemaster. Replace transf #2 high side circuit switcher with a circuit breaker (3000A, 40 kA). Replace the 69kV circuit breaker “66” (3000A, 40kA). Retire 138/69/13 kV 33.6 MVA transf #1, 69 kV circuit breaker “63”, and circuit switcher # 1. **(S2224.7) Estimated Cost: \$1.6M**
- At Lemaster station, install a 138kV breaker (3000A 40kA) to accommodate the new circuit. **(S2224.8) Estimated Cost: \$1.0M**
- Remove Rosewood switch. **(S2224.9) Estimated Cost: \$0.1M**

Estimated Cost: \$55.5M

Projected In-Service: 10/01/2024

Supplemental Project ID: S2224.1-9

Project Status: Scoping

Model: N/A

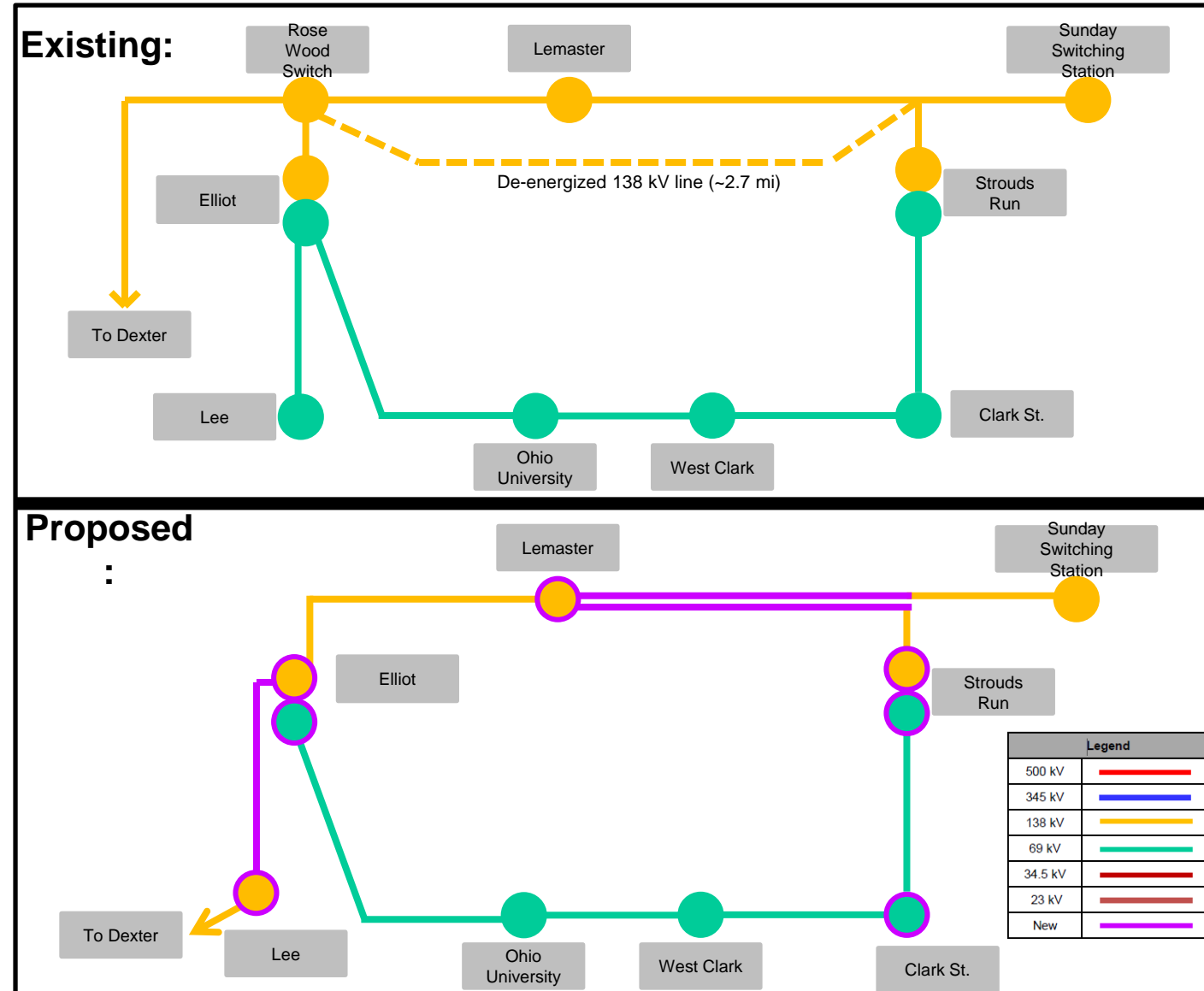

AEP Transmission Zone M-3 Process Lamping - Woodsfield

Need Number: AEP-2019-OH037

Process Stage: Submission of Supplemental Project for inclusion in the Local Plan
05/11/2020

Previously Presented:

Needs Meeting 6/17/2019

Solutions Meeting 3/19/2020

Project Driver:

Customer Service and Operational Flexibility

Specific Assumption Reference:

AEP Guidelines for Transmission Owner Identified Needs (AEP Assumptions Slides 7 and 8)

Problem Statement:

The Cameron-Switzer 69kV circuit is 16.2 miles long and serves 3 wholesale customer stations (over 3,800 customers), with a combined peak load of 11 MW.

The circuit is radially fed from AEP's Switzer Station, making it difficult to perform proactive maintenance or restoration activities after an outage. The circuit is located in a remote part of AEP's service territory and traverses very hilly and wooded terrain.

The 69kV transmission line is of wood pole construction and was built in 1970. There are currently 121 open conditions on the circuit, with the majority being structure deficiencies (e.g., burnt insulators, insect damage, & cracked cross-braces).

In addition, the City of Woodsfield is served via a 69kV hard tap, with no line sectionalizing switches present.

South Central Power Co-op has reported 1.1 million customer-outage minutes (CMI) over a three year period (2015-2017).

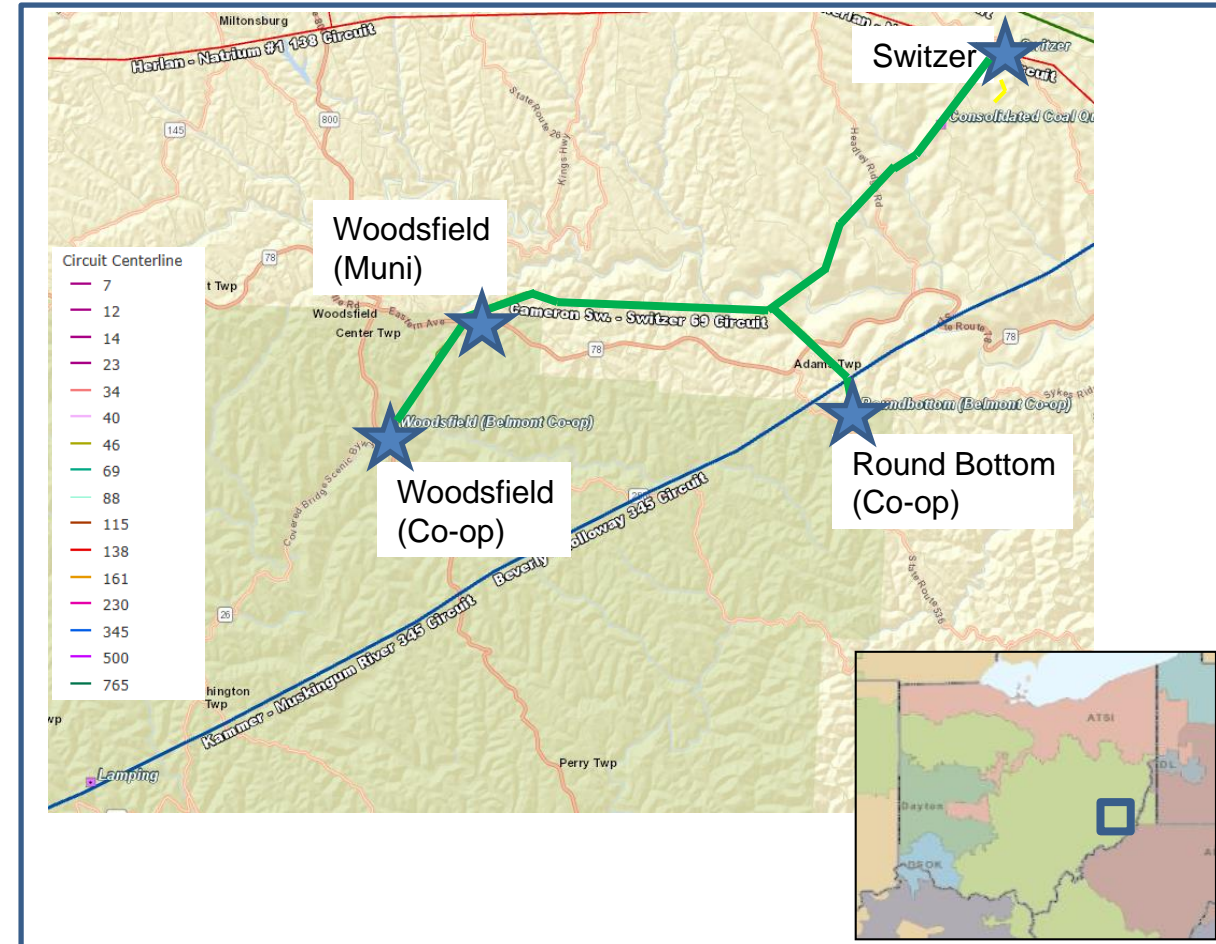

AEP Transmission Zone M-3 Process

Lamping - Woodsfield

Need Number: AEP-2019-OH037

Process Stage: Submission of Supplemental Project for inclusion in the Local Plan 05/11/2020

Selected Solution:

At Lamping station, install a 138kV breaker string with 2 breakers, a 90 MVA 138-69kV transformer, and 1- 69kV breaker. **(S2216.1) Estimated Cost: \$4.8M**

Construct a 10-mile 69kV transmission line between Lamping and the Woodsfield area. **(S2216.2) Estimated Cost: \$19.9M**

At the existing Woodsfield Co-op station, install a 3-way 69kV switch with SCADA functionality (Cranes Nest Switch). **(S2216.3) Estimated Cost: \$0.6M**

At the existing hard tap to Woodsfield Municipal, install a 3-way 69kV switch with SCADA functionality (Standingstone Switch). **(S2216.4) Estimated Cost: \$0.6M**

Remove the existing Cameron 2-way switch and install a new 3-way 69kV switch with SCADA functionality. **(S2216.5) Estimated Cost: \$0.6M**

At Switzer station, install 2- 138kV line breakers (toward Herlan & Natrium). **(S2216.6) Estimated Cost: \$1.1M**

At the 138kV remote-end of Natrium, replace the line protection relays to coordinate with the upgrade at Switzer. **(S2216.7) Estimated Cost: \$0.6M**

Modify the existing Switzer-Woodsfield 69kV transmission line on each side of the switches due to the switch installation. **(S2216.8) Estimated Cost: \$1.9M**

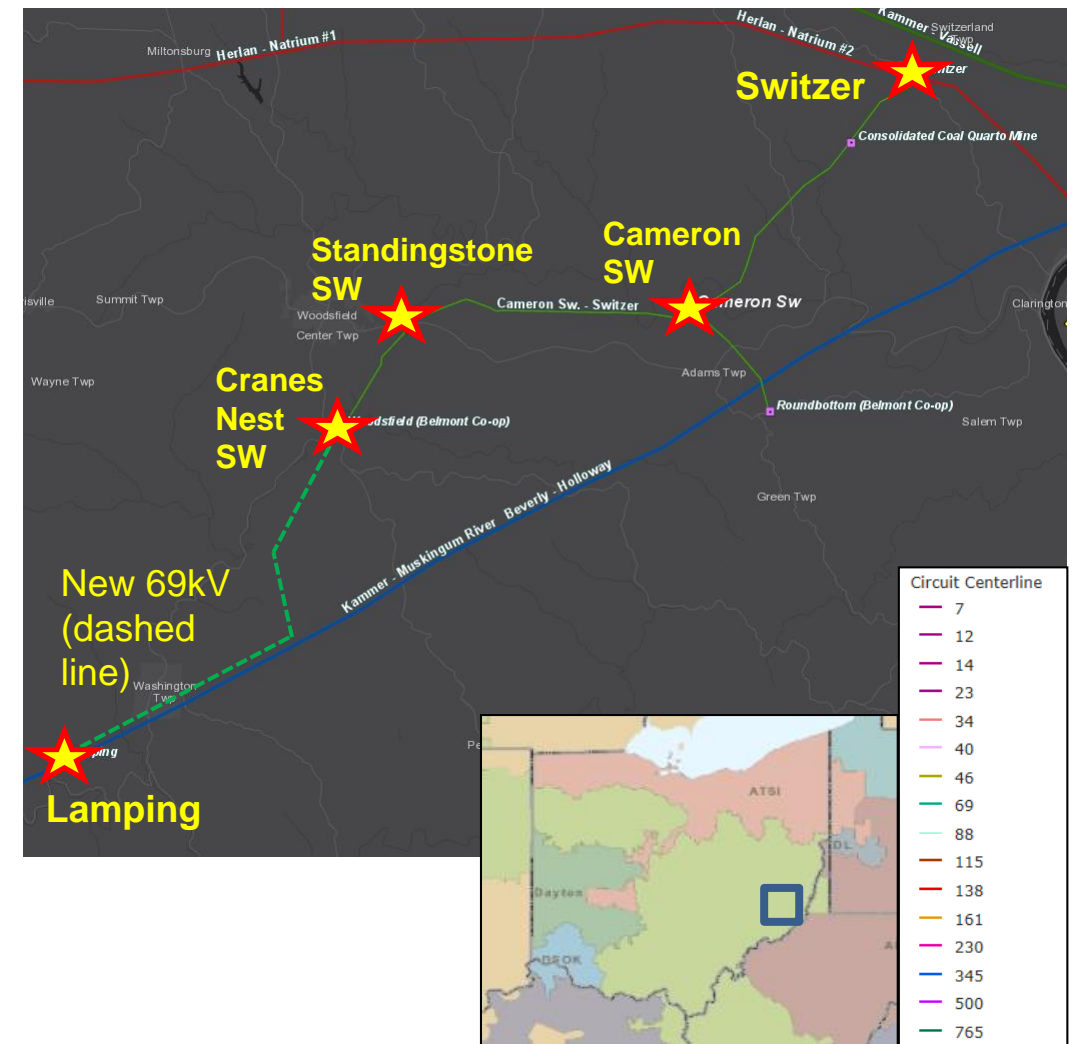

AEP Transmission Zone M-3 Process Lamping - Woodsfield

Legend	
500 kV	
345 kV	
138 kV	
69 kV	
34.5 kV	
23 kV	
New	

Ancillary Benefits: Improved reliability for the 3 wholesale customer stations served from the 69kV circuit; increased ability for AEP to maintain the existing 69kV transmission line and Switzer station equipment (without dropping customers).

Estimated Cost: \$30.1M

Projected In-Service: 5/1/2023

Supplemental Project ID: S2216.1-.8

Project Status: Scoping

Model: PJM 2019 RTEP Series Models

Existing:

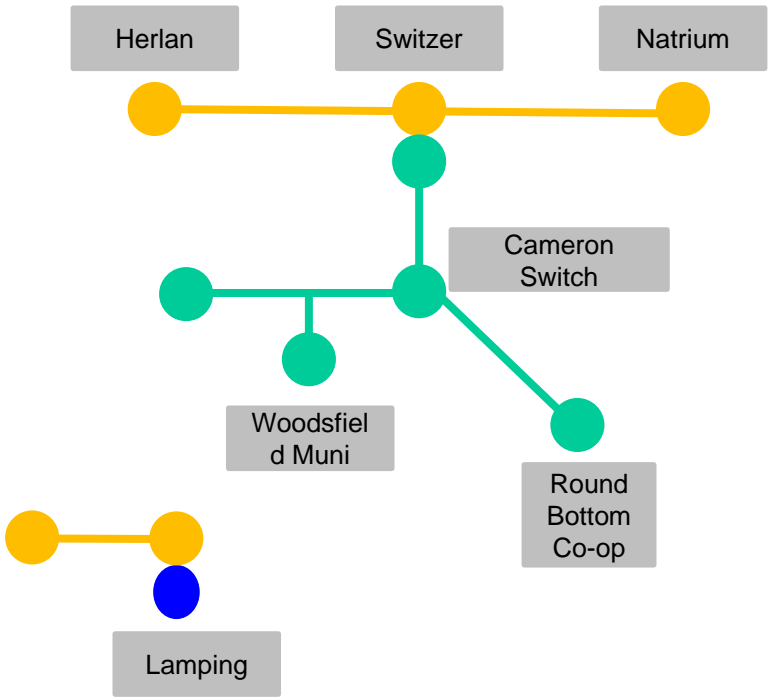

Proposed:

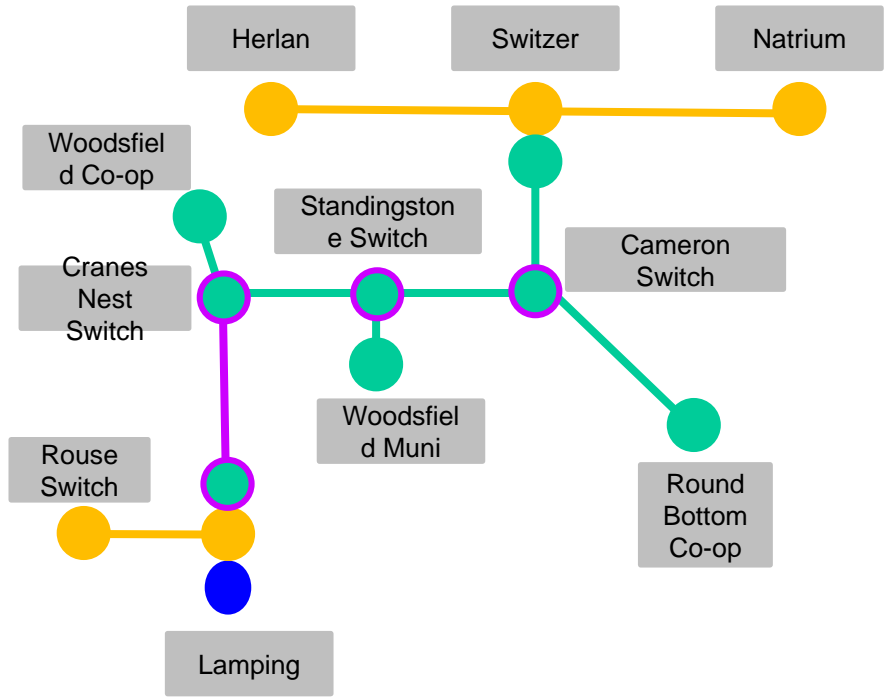

AEP Transmission Zone M-3 Process Hyatt XFMR

Need Number: AEP-2019-OH038

Process Stage: Submission of Supplemental Project for inclusion in the Local Plan
05/11/2020

Previously Presented:

Needs Meeting 6/17/2019

Solutions Meeting 3/19/2020

Project Driver:

Equipment Material/Condition/Performance/Risk, Operational Flexibility and Efficiency

Specific Assumption Reference:

AEP Guidelines for Transmission Owner Identified Needs (AEP Assumptions Slide 8)

Problem Statement:

138kV circuit breaker 105S at Hyatt station is showing signs of deterioration. This is an oil breaker installed in 1980. Oil breaker maintenance has become more difficult due to the oil handling required to maintain them. Oil spills are frequent with breaker failures and routine maintenance and can become an environmental hazard. This is the last remaining oil breaker at Hyatt.

Transformer 1A has failed at Hyatt station and needs to be replaced. Transformer 1B is the same age (1973) and type, and Transmission Field Services has expressed similar concerns with 1B as they did with 1A (pre-failure), including dielectric breakdown (insulation), accessory damage (bushings), and short circuit breakdown (due to through faults).

The existing configuration of Hyatt station includes both 345/138kV transformers in the same protection zone. The 345kV side of this zone is only energized from one bus such that a single bus outage would outage both transformers.

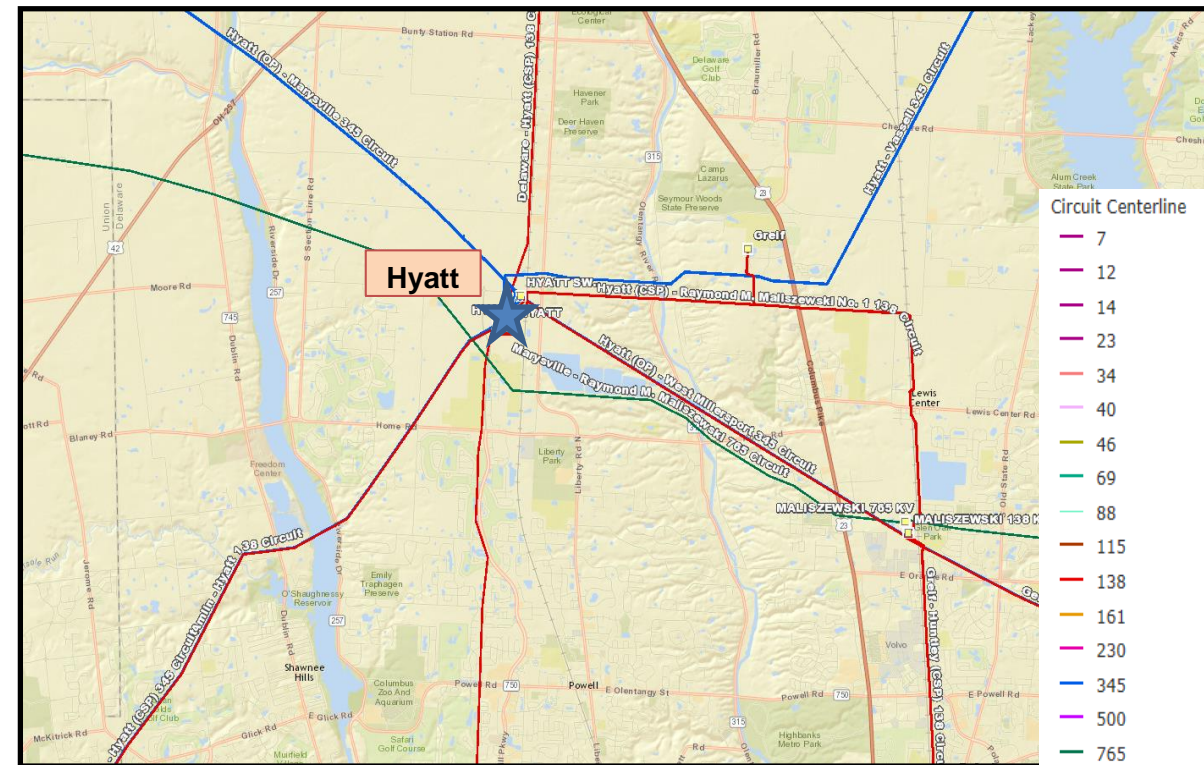

AEP Transmission Zone M-3 Process Hyatt XFMR

Need Number: AEP-2019-OH038

Process Stage: Submission of Supplemental Project for inclusion in the Local Plan 05/11/2020

Selected Solution:

At Hyatt station, replace 2-345/138kV 300MVA transformers 1A & 1B with 450 MVA units. Install 3-345kV 5,000A / 63kA circuit breakers to separate the transformer protection zones. Replace 138kV breaker 105S with a 3,000A / 63kA breaker. Install new 138kV 3,000A breakers to terminate the second transformer. **(S2217)**

Estimated Cost: \$25M

Projected In-Service: 11/27/2019

Supplemental Project ID: S2217

Project Status: In Service (Failure Replacement)

Model: 2024 Summer

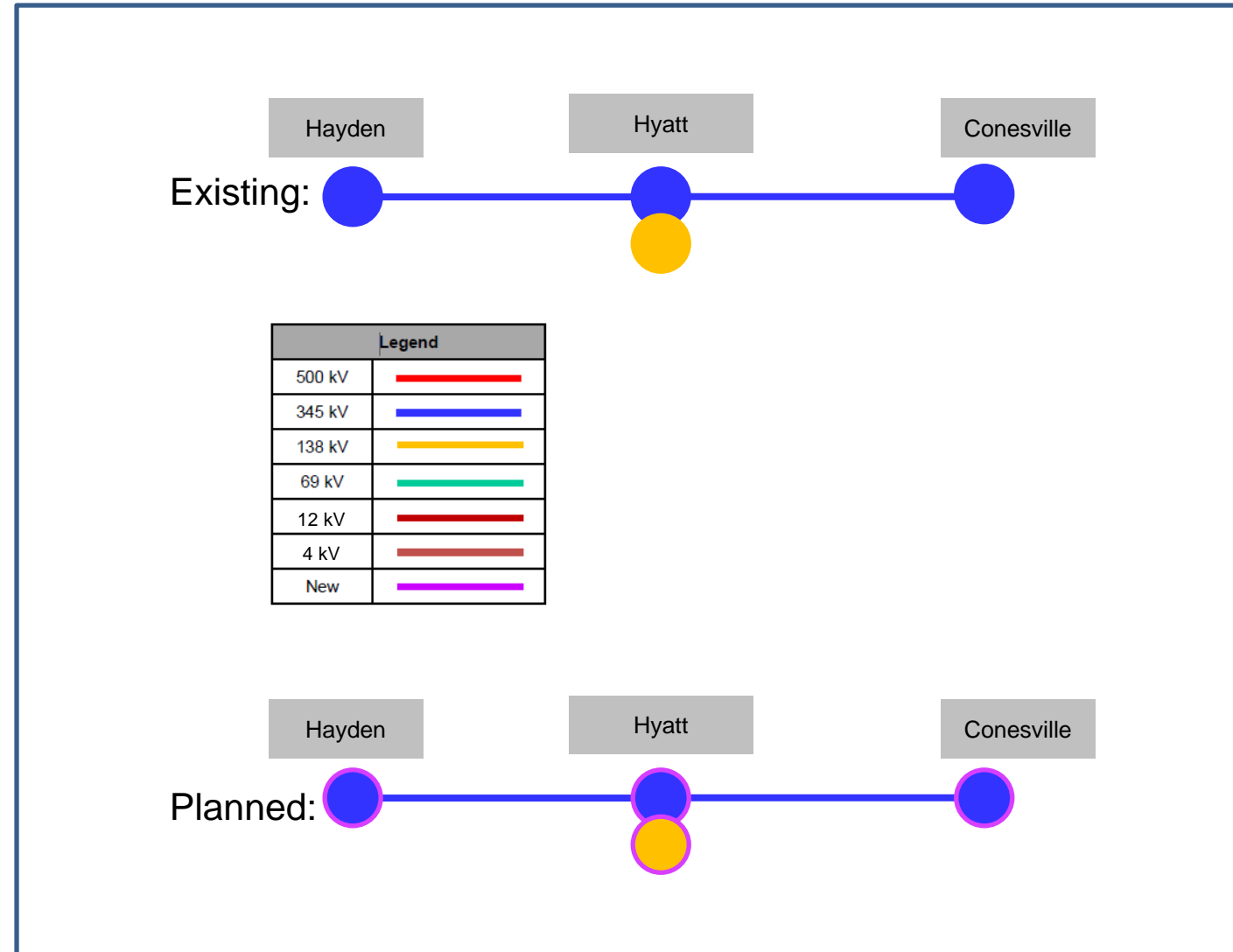

AEP Transmission Zone M-3 Process

Senecaville Loop 69kV

Need Number: AEP-2019-OH040

Process Stage: Submission of Supplemental Project for inclusion in the Local Plan 05/11/2020

Previously Presented:

Needs Meeting 06/17/2019

Solutions Meeting 03/19/2020

Project Driver:

Operational Flexibility and Customer Service

Specific Assumption Reference:

AEP Guidelines for Transmission Owner Identified Needs (AEP Assumptions slides 7 and 8);

Problem Statement:

Derwent – Senecaville 69 kV circuit

- The Derwent – Senecaville 69 kV circuit is ~4.3 miles long and serves a AEP Ohio and Guernsey-Muskingum Electric Cooperative station radially out of Derwent station.
- Guernsey-Muskingum Electric Cooperative and AEP Ohio customers are currently served off the radial line.
- Maintenance on the line is difficult to coordinate as it requires outages to multiple stations.
- Guernsey-Muskingum Electric Cooperative has reported approximately 210,000 customer-outage minutes (CMI) over a three year period (2015-2017).

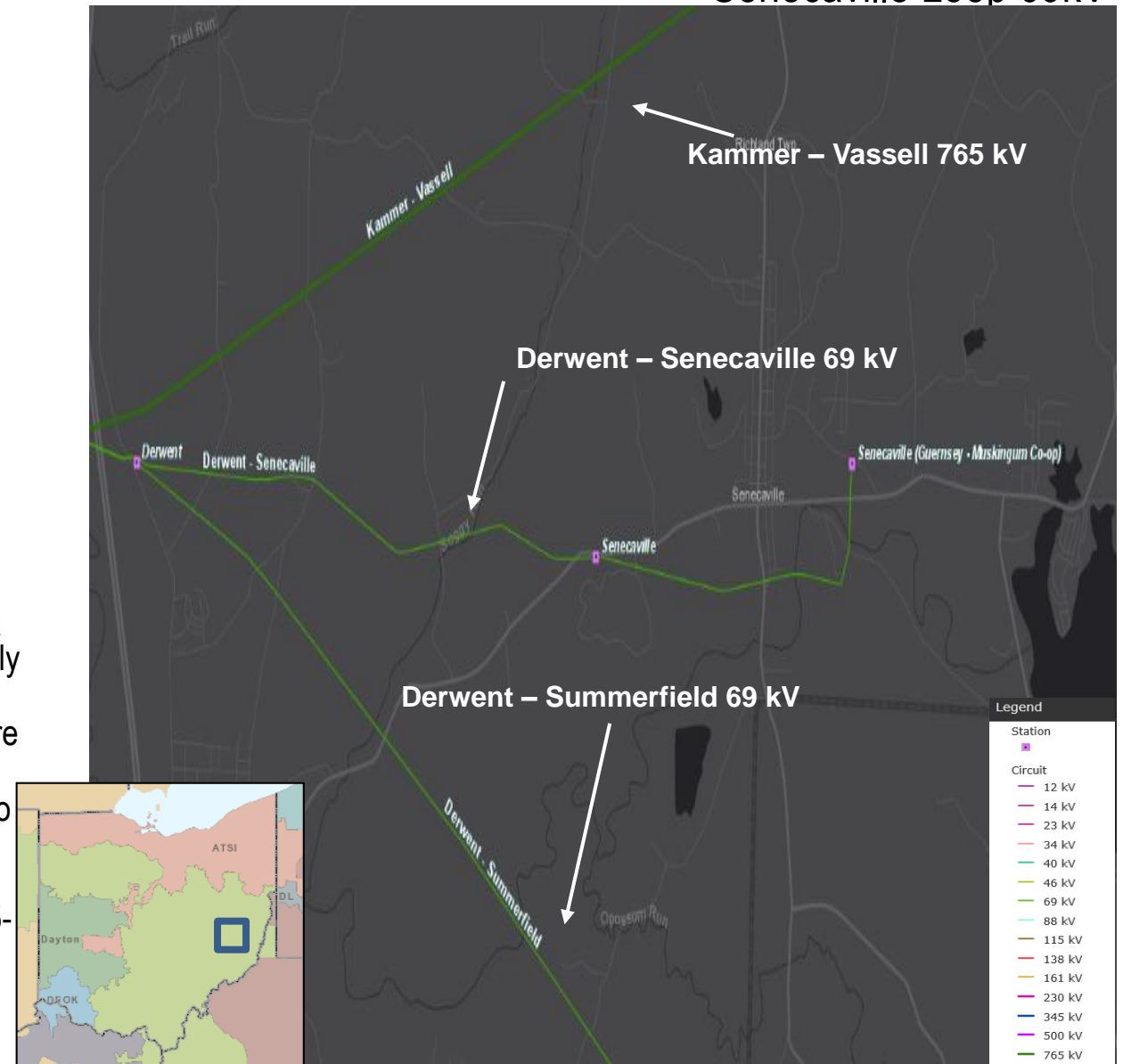

AEP Transmission Zone M-3 Process

Senecaville Loop 69kV

Need Number: AEP-2019-OH047

Process Stage: Submission of Supplemental Project for inclusion in the Local Plan 05/11/2020

Previously Presented:

Needs Meeting 07/24/2019

Solutions Meeting 03/19/2020

Project Driver:

Equipment Material/Condition/Performance/Risk

Specific Assumption Reference:

AEP Guidelines for Transmission Owner Identified Needs

Problem Statement:

Derwent –Summerfield 69kV

- Majority of 3.3 miles circuit utilizes wood structures installed in 1962.
- Circuit utilizes 336.4 kCM ACSR 30/7 Oriole conductor installed in 1962.
- Five momentary and permanent outages over last three years.
- 20 Open Structure/Conductor conditions
 - Insect damage, woodpecker holes, along with rotted and cracked structures.

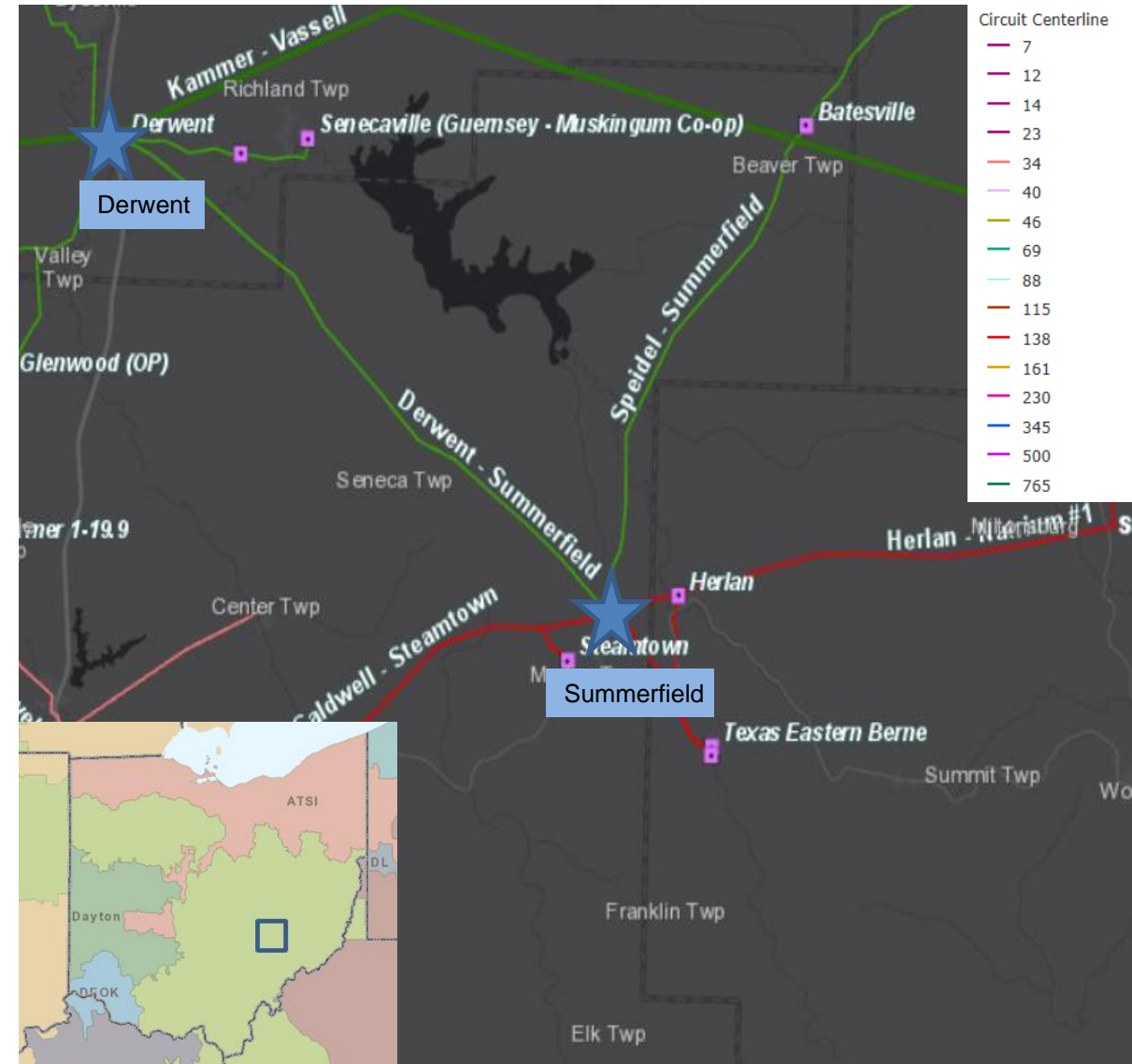

AEP Transmission Zone M-3 Process Senecaville Loop 69kV

Need Number: AEP-2019-OH040 & AEP-2019-OH047

Process Stage: Submission of Supplemental Project for inclusion in the Local Plan 05/11/2020

Selected Solution:

- Remove ~3.3 miles of the Derwent – Summerfield 69 kV line. (**S2221.1**)
Estimated Cost: \$2.0M
- Build a new 69 kV line (~2.42 miles) from Lashley to the existing Summerfield line to loop the customers served from the existing radial. (**S2221.2**) **Estimated Cost: \$6.1M**
- Install a new 69kV 1200A 3-way POP switch (Lashley) with auto-sectionalizing MOABs to serve the Senecaville GM co-op. (**S2221.3**)
Estimated Cost: \$1.1M
- Install 1 - 69kV 2000A wave trap at Senecaville (AEP) Station for relaying coordination. (**S2221.4**) **Estimated Cost: \$0.1M**
- Install 1 - 69kV 2000A wave trap at the GM Senecaville Station for relaying coordination. (**S2221.5**) **Estimated Cost: \$0.1M**
- At Derwent station, remove the Summerfield line exit and associated equipment. (**S2221.6**) **Estimated Cost: \$0.4M**

Estimated Cost: \$9.8M

Projected In-Service: 11/01/2024

Supplemental Project ID: S2221.1-6

Project Status: Engineering

Model: N/A

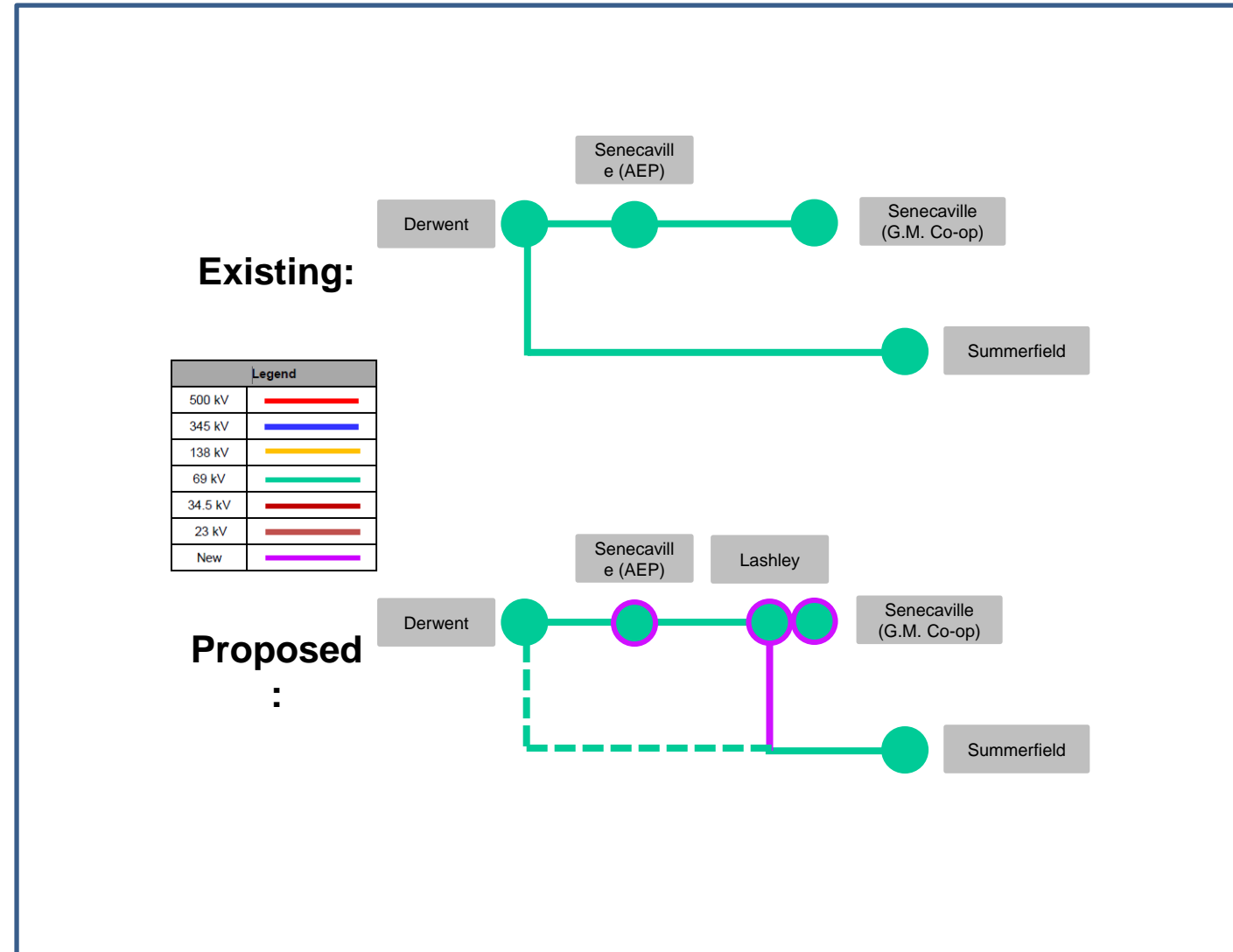

AEP Transmission Zone M-3 Process Service to Ilesboro (65-91) 138kV

Need Number: AEP-2019-OH044

Process Stage: Submission of Supplemental Project for inclusion in the Local Plan 05/11/2020

Previously Presented:

Needs Meeting 7/24/2019

Solutions Meeting 3/19/2020

Project Driver:

Customer Service

Specific Assumption Reference:

AEP Guidelines for Transmission Owner Identified Needs (AEP Assumptions slide 7)

Problem Statement:

South Central Power is requesting a new 138kV delivery point on the Lemaster –Ross 138 kV circuit by September 2020. Anticipated load is about 4 MW.

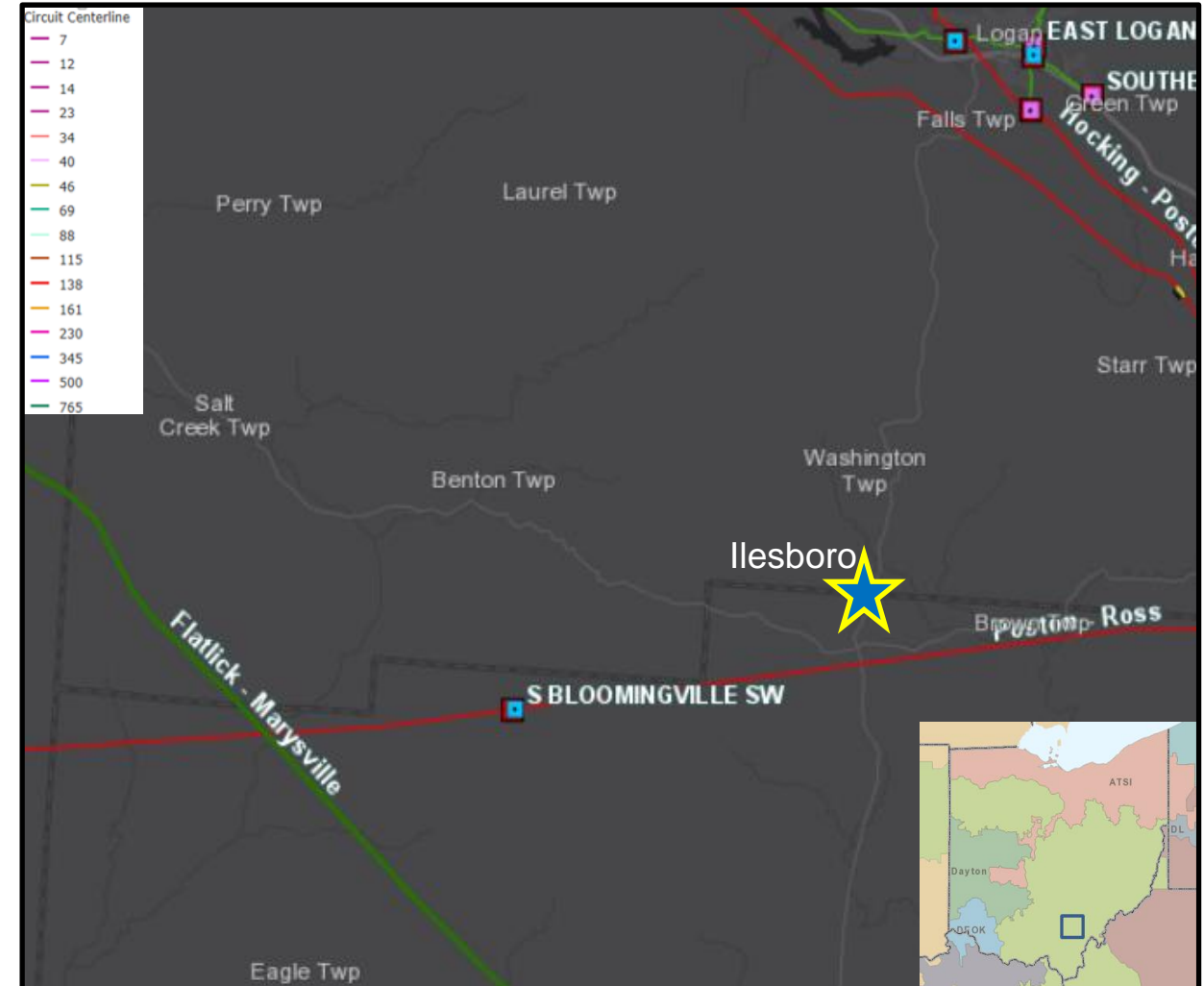

AEP Transmission Zone M-3 Process Service to Ilesboro (65-91) 138kV

Need Number: AEP-2019-OH044

Process Stage: Submission of Supplemental Project for inclusion in the Local Plan 05/11/2020

Selected Solution:

- Build a new single circuit 138 kV line (~1.5 mi) to connect the new Ilesboro delivery point to the Lemaster - Ross 138kV circuit using 336.4 ACSR. **(S2222.1) Estimated Cost: \$4.3M**
- Install a new 3-way phase over phase 138 kV 2000 A switch (Fiddlestix) with MOABs on the Lemaster – Ross 138kV circuit. Update remote end work at Lemaster. **(S2222.2) Estimated Cost: \$0.9M**

Estimated Cost: \$5.2M

Projected In-Service: 12/1/2022

Supplemental Project ID: S2222.1-.2

Project Status: Engineering

Model: 2024 Summer RTEP

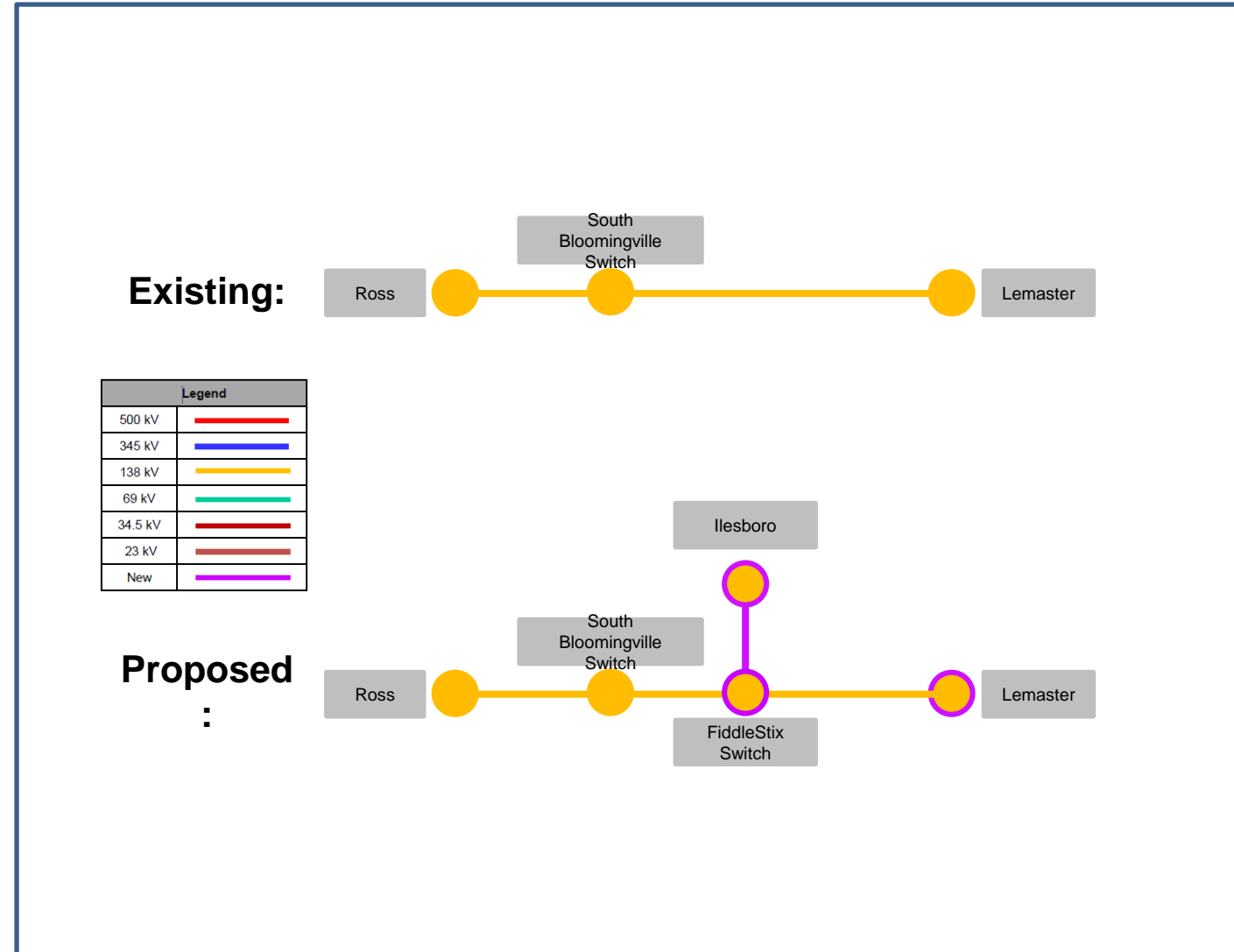

AEP Transmission Zone M-3 Process Bladensburg

Need Number: AEP-2019-OH050

Process Stage: Submission of Supplemental Project for inclusion in the Local Plan 05/11/2020

Previously Presented:

Needs Meeting 8/29/2019

Solutions Meeting 3/19/2020

Project Driver:

Equipment Material/Condition/Performance/Risk

Specific Assumption Reference:

AEP Guidelines for Transmission Owner Identified Needs

Problem Statement:

- The Bladensburg Licking Rural Electrification Co-op (LRE) 138 kV delivery point, connected to the 45 mile North Bellville – Ohio Central 138 kV circuit, has a load of 3.9 MW peak demand serving 1449 customers. The Bladensburg load is 100% transferrable but under high loading conditions transferring loads can take several hours. For heavy loading periods LRE has experienced areas of low voltage while transferring loads.
- The Bladensburg delivery point has experienced approximately 553,000 minutes of CMI over the last 5 years.
- This delivery point is connected to the North Belleville – Ohio Central 138 kV circuit via a hard tap which limits operational flexibility and the effectiveness of protection schemes. In addition, it is difficult to coordinate maintenance efforts because the line cannot be removed from service without either a customer outage or temporary jumper configuration.

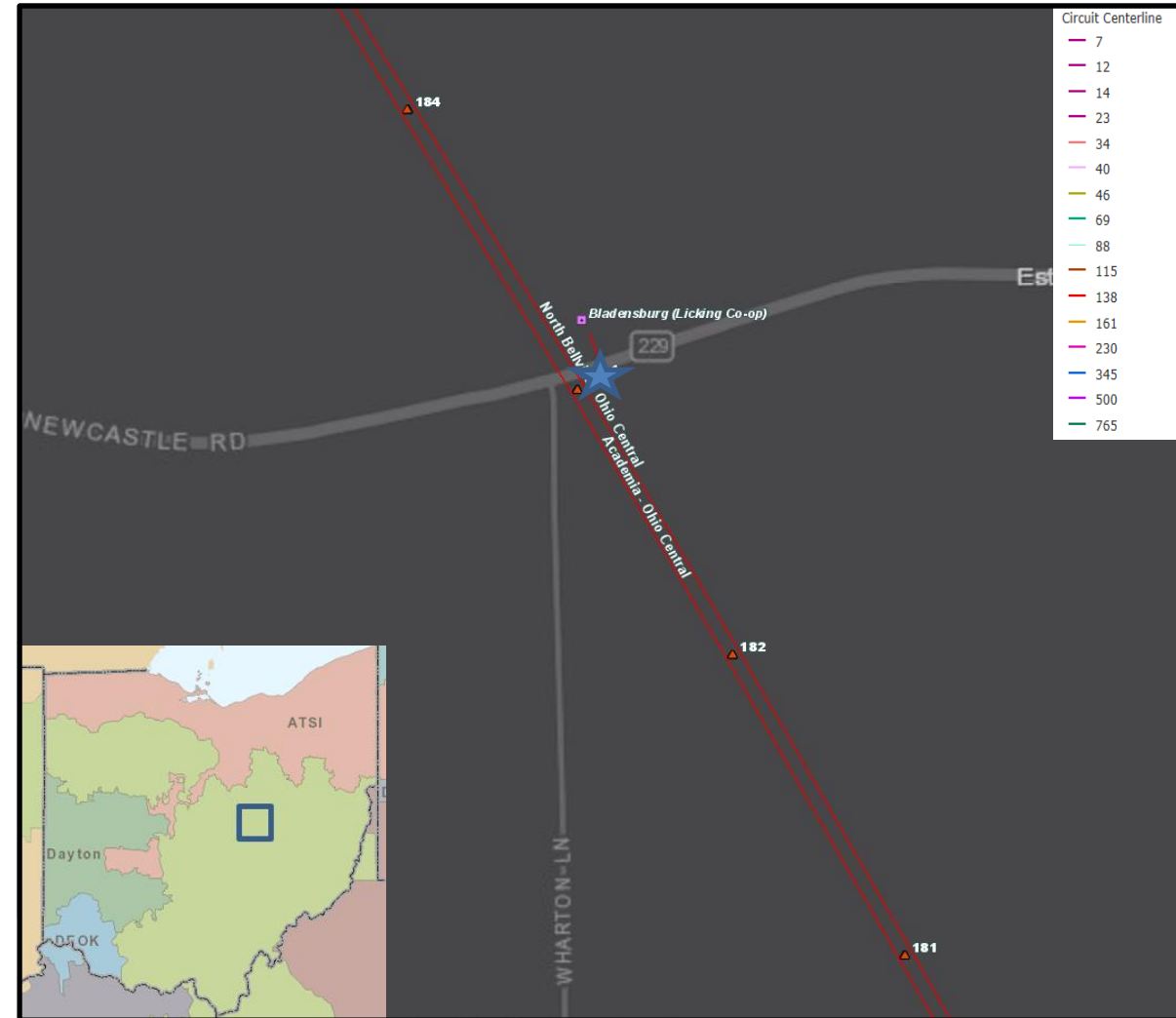

AEP Transmission Zone M-3 Process Bladensburg

Need Number: AEP-2019-OH050

Process Stage: Submission of Supplemental Project for inclusion in the Local Plan 05/11/2020

Selected Solution:

- Install a new 3-way 1200A switch with Auto-Sectionalizing, MOABs, and SCADA to serve the existing Bladensburg Delivery Point (Wakatomika). Additional structure work on the existing line will be required to accommodate the new switching structure. **(S2218)**

Ancillary Benefits: Removes a hard tap from the 138kV system and provides a more reliable service to customers.

Estimated Cost: \$1.90M

Projected In-Service: 4/15/2021

Supplemental Project ID: S2218

Project Status: Engineering

Model: N/A

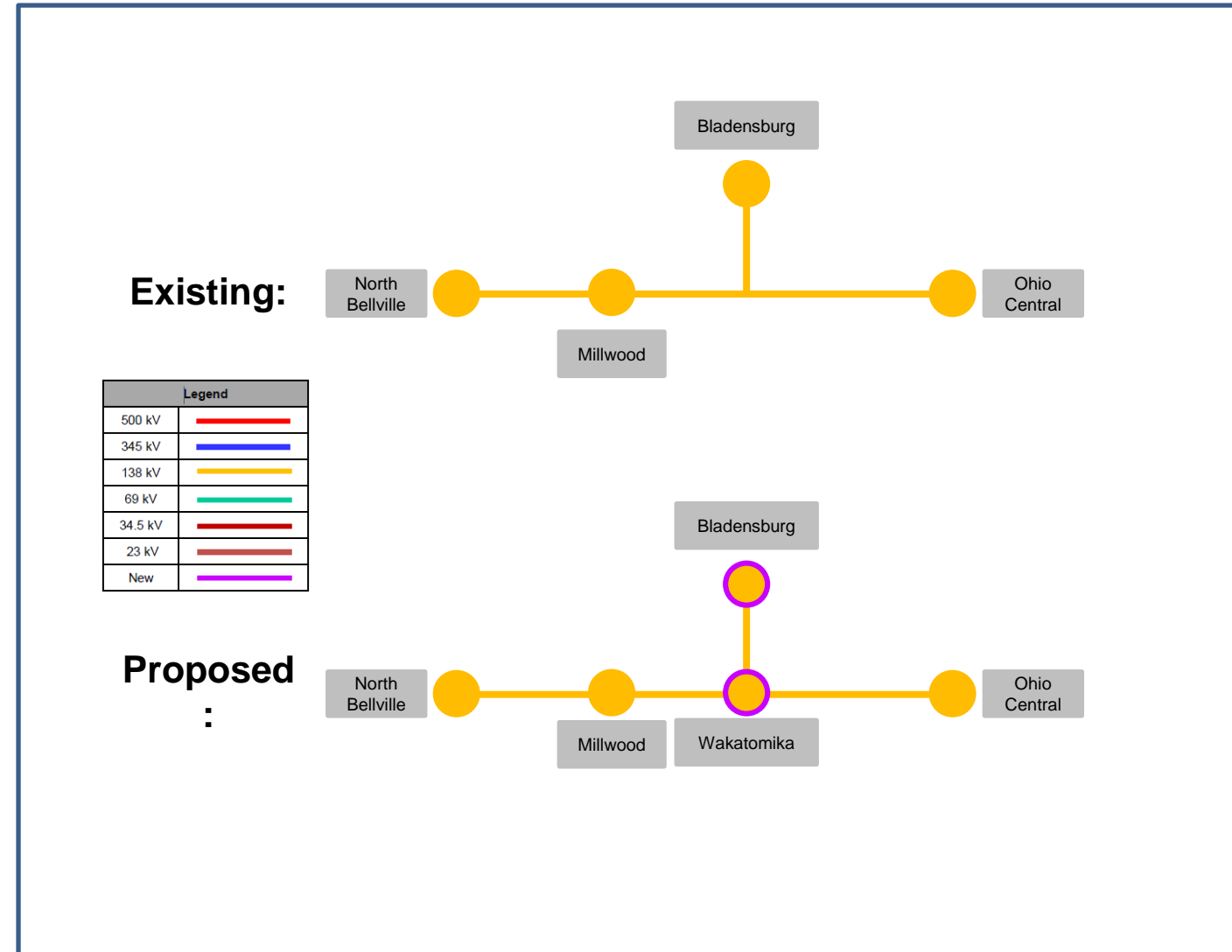

AEP Transmission Zone M-3 Process Crooksville-Philo 138kV Circuit Rebuild

Need Number: AEP-2020-OH004

Process Stage: Submission of Supplemental Project for inclusion in the Local Plan 05/11/2020

Previously Presented:

Needs Meeting 2/21/2020

Solutions Meeting 3/19/2020

Project Driver:

Equipment Material/Condition/Performance/Risk

Specific Assumption Reference:

AEP Guidelines for Transmission Owner Identified Needs (AEP Assumptions Slide 8), AEP Presentation on Pre-1930s Lines

Problem Statement:

Crooksville – Philo 138kV

- Length: 13 Miles
- Original Construction Type: Aluminum/Steel Lattice
- Original Conductor Type: 397.5 ACSR Lark / 636 ACSR Grosbeak (vintage 1926)
- Momentary/Permanent Outages: 1 total outages
 - CMI: 320,767
 - Number of open conditions: 5
 - Total structure count: 65
 - Open conditions include: Burnt insulators, damaged shield wire
- Please reference assumptions materials on pre-1930s era lattice lines

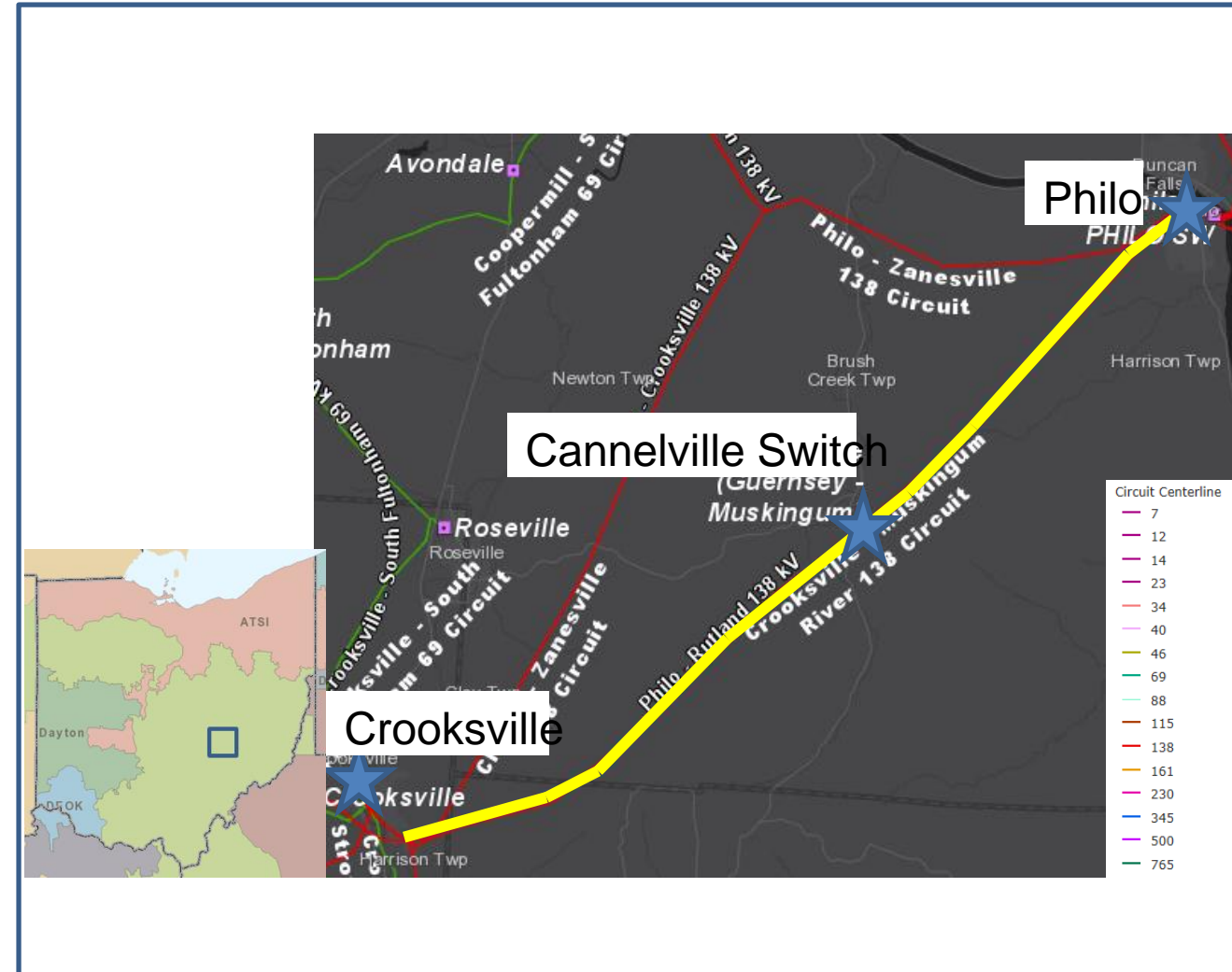

AEP Transmission Zone M-3 Process Crooksville-Philo 138kV Circuit Rebuild

Need Number: AEP-2020-OH004

Process Stage: Submission of Supplemental Project for inclusion in the Local Plan 05/11/2020

Selected Solution:

- Rebuild ~12 miles of the Crooksville – Philo 138kV circuit. **(S2223.1) Estimated Cost: \$29.8M**
- Replace Cannelville Switch with a new phase-over-phase switch. Relocate the existing Cannelville – Guernsey-Muskingum Co-op 138kV line to new Cannelville Switch. The switch needs to be relocated to maintain service to the customer while the line is being rebuilt. **(S2223.2) Estimated Cost: \$1.1M**

Estimated Cost: \$30.9M

Projected In-Service: 9/30/2022

Supplemental Project ID: S2223.1-.2

Project Status: Engineering

Model: N/A

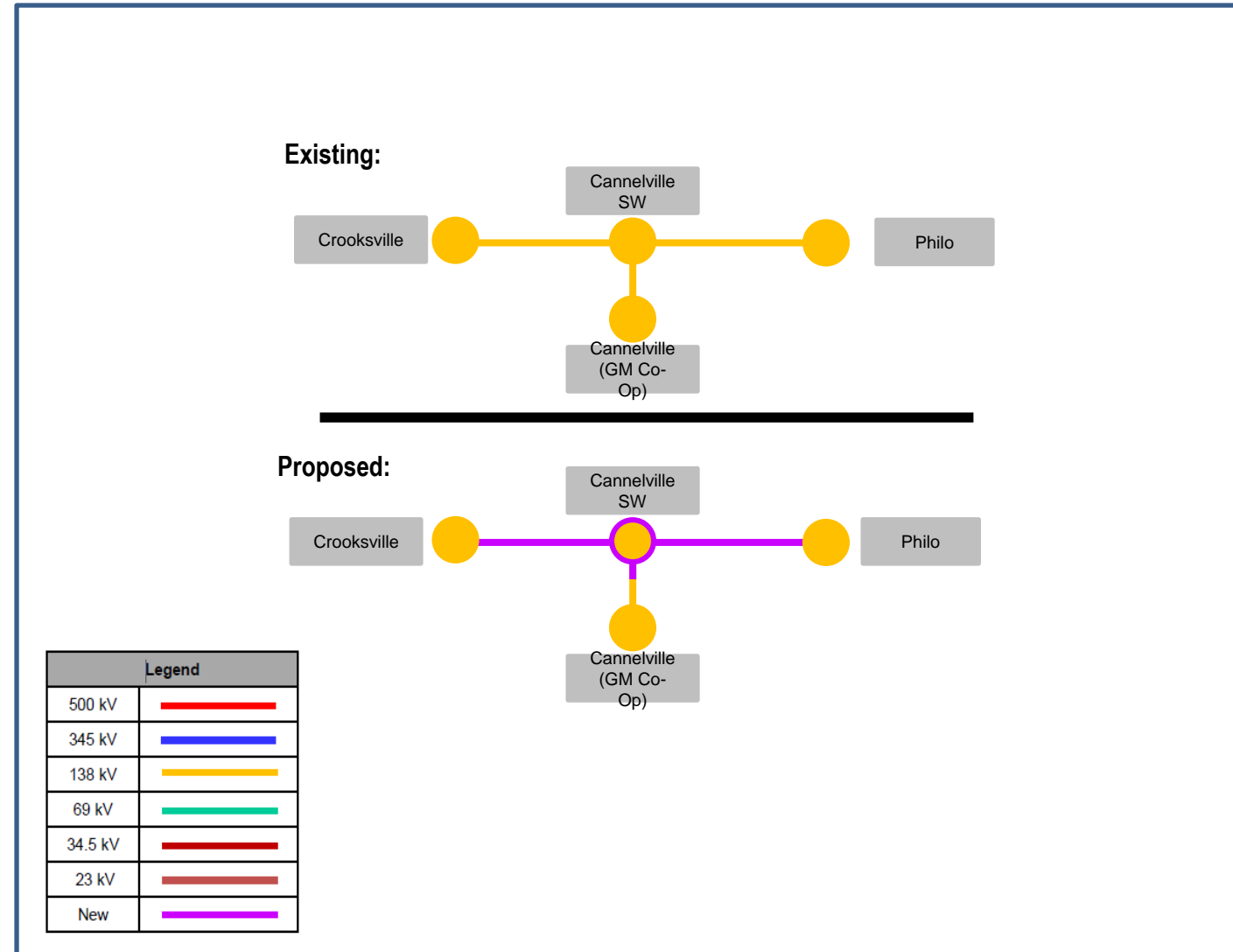

AEP Transmission Zone M-3 Process Apple Valley Switch

Need Number: AEP-2019-OH011

Process Stage: Submission of Supplemental Project for inclusion in the Local Plan 06/15/2020

Previously Presented:

Need Meeting 03/25/2019

Solutions Meeting 04/20/2020

Project Driver:

Equipment Material/Condition/Performance/Risk

Specific Assumption Reference:

AEP Guidelines for Transmission Owner Identified Needs

Problem Statement:

- The Apple Valley (Licking Co-op) 138 kV delivery point serves approximately 2,300 customers with a peak demand of 6.5 MW. Apple Valley isn't 100% transferrable during all times of the year and can take several hours to complete the required switching. This delivery point has experienced 971,280 customer minutes of interruption.
- This delivery point is connected with a hard tap which limits sectionalizing during outages and maintenance. In addition, relay coordination can be difficult with hard taps.



AEP Transmission Zone M-3 Process Apple Valley Switch

Need Number: AEP-2019-OH011

Process Stage: Submission of Supplemental Project for inclusion in the Local Plan 06/15/2020

Selected Solution:

- Install a new 3-way phase over phase 138 kV 2000 A switch (Apple Valley Switch) with SCADA, Auto-Sectionalizing MOABs outside of the Apple Valley (Licking Co-op) Station. **(S2248.1) Estimated Cost: \$0.84M**
- Rebuild the existing radial hard tap ~0.24 Miles as a double circuit with 556.5 ACSR 26/7. **(S2248.2) Estimated Cost: \$1.54M**

Ancillary Benefits: Removes a hard tap from the 138kV system and provides a more reliable service to customers.

Estimated Cost: \$2.38 M

Projected In-Service: 05/01/2021

Supplemental Project ID: S2248.1 -.2

Project Status: Engineering

Model: 2023 Summer RTEP

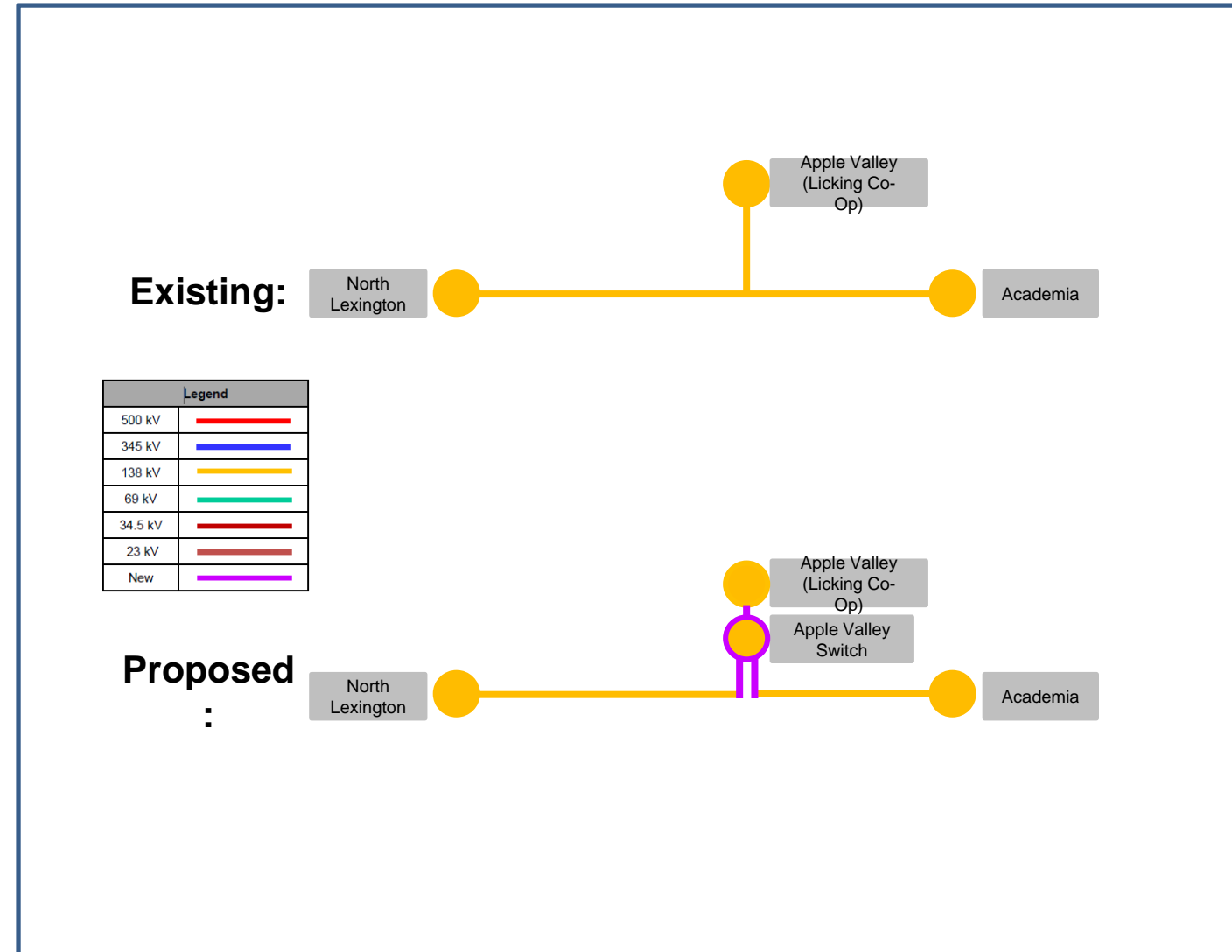

AEP Transmission Zone M-3 Process Holston Station Improvements

Need Number: AEP-2019-AP021

Process Stage: Submission of Supplemental Project for inclusion in the Local Plan
06/15/2020

Previously Presented:

Needs Meeting 05/20/2019

Solutions Meeting 04/20/2020

Project Driver:

Equipment Material/ Condition/Performance/Risk, Operational Flexibility and Efficiency

Specific Assumption Reference:

AEP Guidelines for Transmission Owner Identified Needs (AEP Assumptions Slide 8)

Problem Statement:

Holston Station

- 138/34.5 kV Transformer #1
 - Manufactured in 1979.
 - Showing signs of dielectric breakdown (insulation), accessory damage (bushings/windings), and short circuit breakdown (due to through faults).
 - Currently tied directly to 138 kV bus #1 via a MOAB on high side.

34.5/23-2.4 kV Transformer #8 (GND Bank)

- Manufactured in 1954.
- Showing signs of dielectric breakdown (insulation), accessory damage (bushings), and short circuit breakdown (due to through faults).



AEP Transmission Zone M-3 Process Holston Station Improvements

Continued from previous slide...

Holston Station

Capacitor switchers 'BB' and 'CC'

- Capacitor switchers 'BB' and 'CC' at Holston station are Mark V model which no longer support modern relaying packages.
- Mark V's have been historically prone to mechanism failures and are being replaced system wide where possible.

34.5/23-2.4 kV Transformer #9 (GND Bank)

- Manufactured in 1953.
- Showing signs of dielectric breakdown (insulation), accessory damage (bushings), and short circuit breakdown (due to through faults).

34.5 kV Circuit breakers E, F, and U

- FK type oil breakers. (1959, 1955, and 1950 vintage)
- These are oil breakers that are difficult to maintain due to the required oil handling. There is an increased potential for oil spills during routine maintenance and failures with these types of breakers.
- Other drivers include damage to bushings and the breakers have experienced 2, 19, and 7 fault operations respectively. The manufacturer's recommendation for this type of breaker is 10.

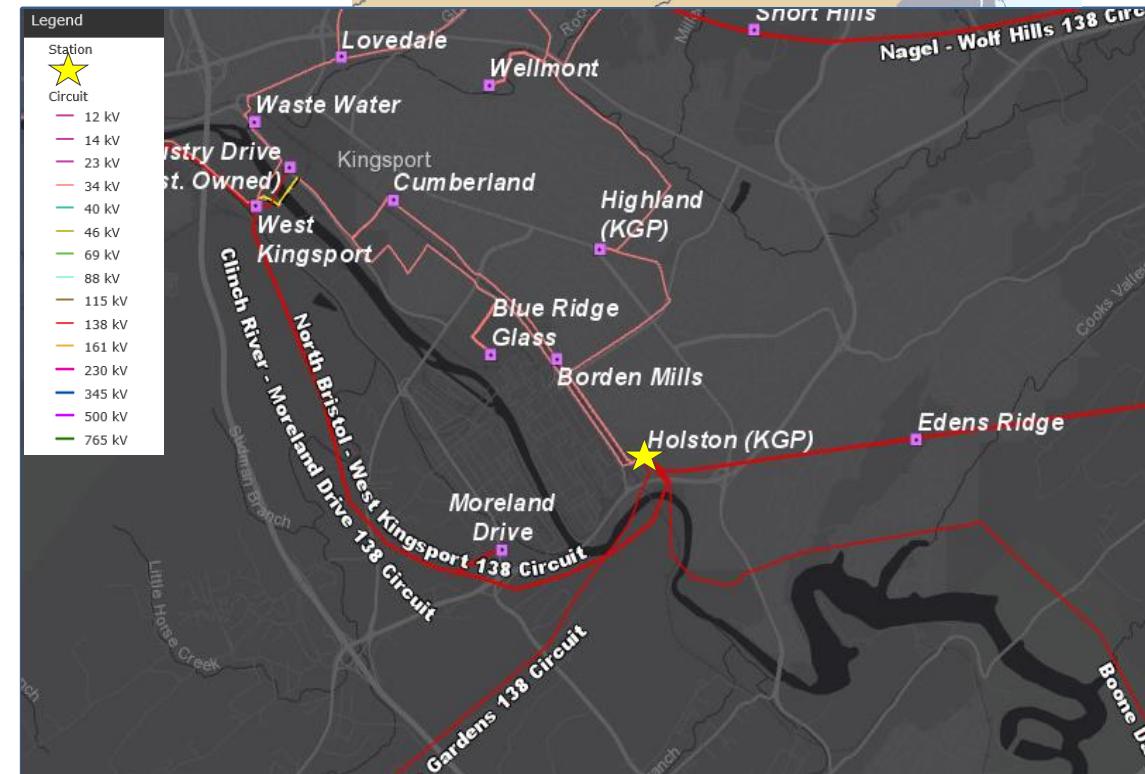
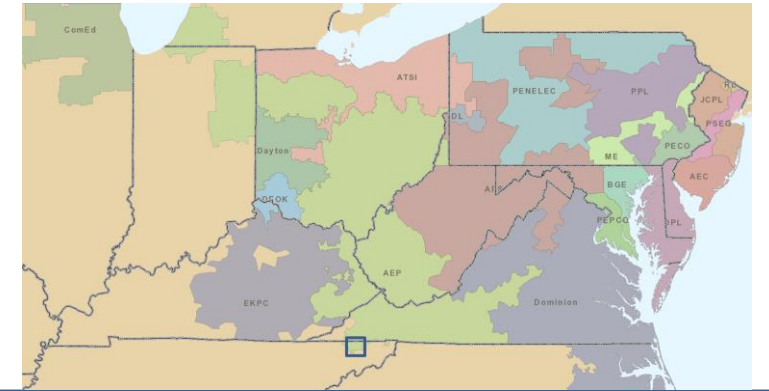

AEP Transmission Zone M-3 Process Holston Station Improvements

Need Number: AEP-2019-AP021

Process Stage: Submission of Supplemental Project for inclusion in the Local Plan 06/12/2020

Selected Solution:

Replace existing 138/34.5 KV 45 MVA transformer #1 with a new 138/69/34.5 KV 90 MVA transformer. Replace existing high side MOAB switches on transformer#1 with new 138 KV 3000 A 40 KA circuit breaker. Replace existing ground transformers #8 and #9 with new ground banks. Reconfigure the existing 34.5 kV into a ring bus configuration with five new 34.5 kV breakers. (**S2249**)

Estimated Cost: \$11.5 M

Projected In-Service: 12/1/2023

Supplemental Project ID: S2249

Project Status: Scoping

Model: N/A

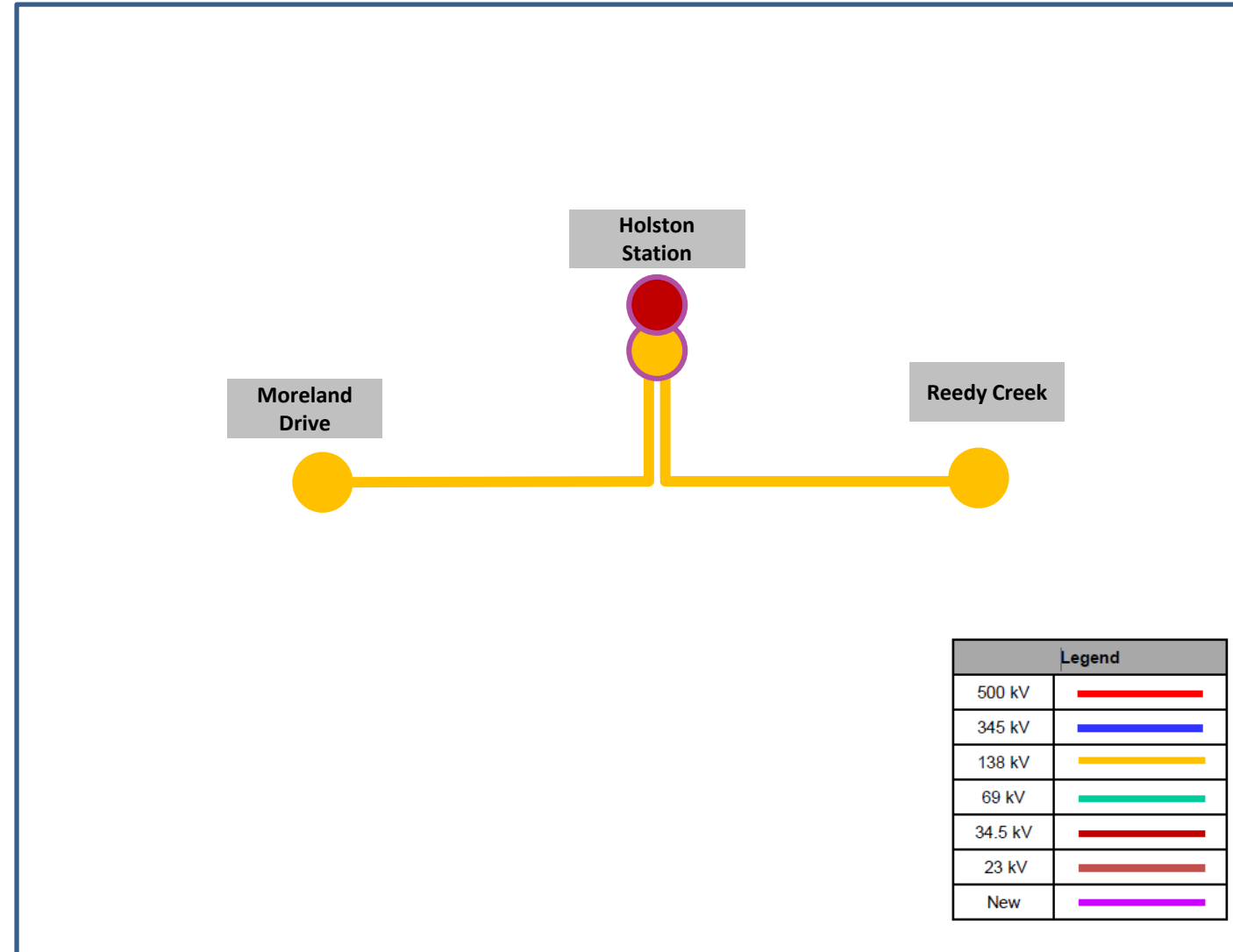

AEP Transmission Zone M-3 Process

Saltville – Kingsport Rebuild

Need Number: AEP-2020-AP005

Process Stage: Submission of Supplemental Project for inclusion in the Local Plan 06/15/2020

Previously Presented:

Needs Meeting 1/17/2020

Solutions Meeting 04/20/2020

Project Driver:

Equipment Condition/Performance/Risk

Specific Assumption Reference:

AEP Guidelines for Transmission Owner Identified Needs (AEP Assumptions Slide 8), AEP Presentation on Pre-1930s Lines

Problem Statement:

Line:

Broadford — Wolf Hills 138 KV (~26 miles installed in the 1920's, ~5.5 miles installed in the 1960's)

- Length: 31.54 Miles
- Original Construction Type: Lattice Steel
- Original Conductor Type: 82.5% 397.5 CM ACSR 30/7, 15.2% 795 CM ACSR 45/7
- Momentary/Permanent Outages: 9/1 (5 years)
- Total structure count: 144
- Number of open conditions: 12
 - Open conditions include: broken conductor strands, broken/burnt insulators.
- Unique structure count with open conditions: 6 (7%)
- Additional Info: Insulator & Hardware Corrosion:
 - Section Loss: The connecting elements including the tower attachment hole and the insulator hook have experienced serious section loss due to corrosion and wear. This loss of metal cross-section significantly reduces the capacity of the connection
 - Corrosion: The insulator caps and connecting hardware have experienced heavy to complete loss of galvanizing. When the protective galvanized coating is gone or significantly compromised the bare steel corrodes at an accelerated rate
 - Tower members with corrosion and damage. Lattice tower structures have little structural redundancy. A failure of one member of the structure will impact the integrity of the structure and may cause the entire tower to collapse.

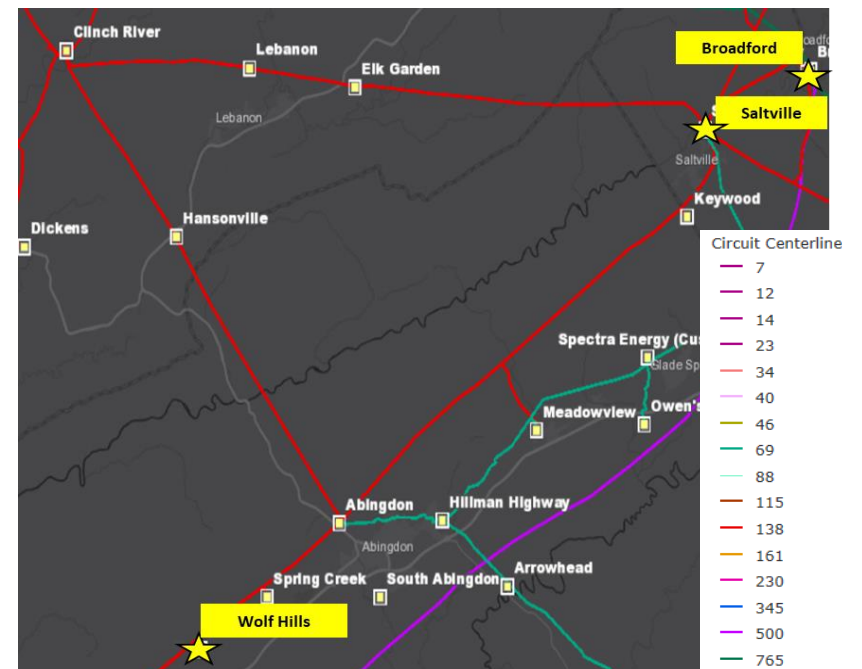
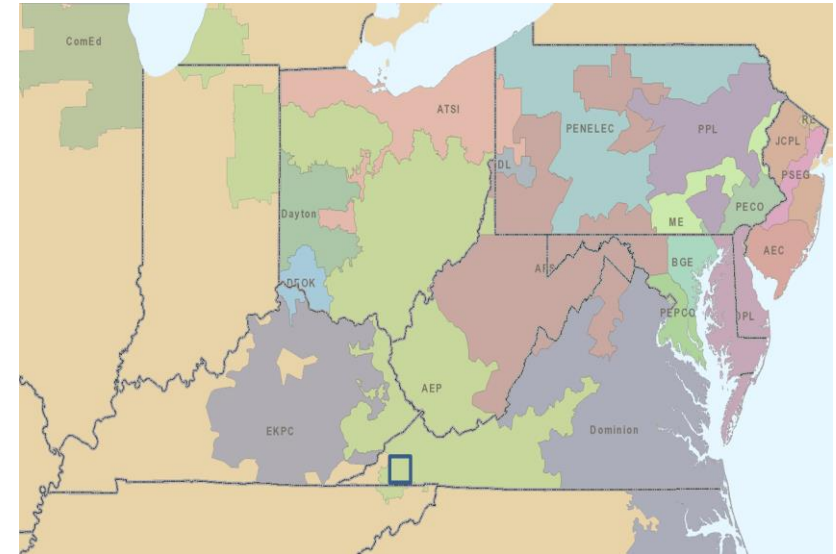

AEP Transmission Zone M-3 Process Saltville – Kingsport rebuild

Need Number: AEP-2020-AP005

Process Stage: Submission of Supplemental Project for inclusion in the Local Plan 06/15/2020

Selected Solution:

- Rebuild the existing Broadford - Wolf Hills/Clinch River - Saltville #2 138kV double circuit line (~26 miles) section between Saltville and Wolf Hills stations. (**S2250**)

Estimated Cost: \$107.1 M

Projected In-Service: 05/01/2024

Supplemental Project ID: S2250

Project Status: Scoping

Model: N/A

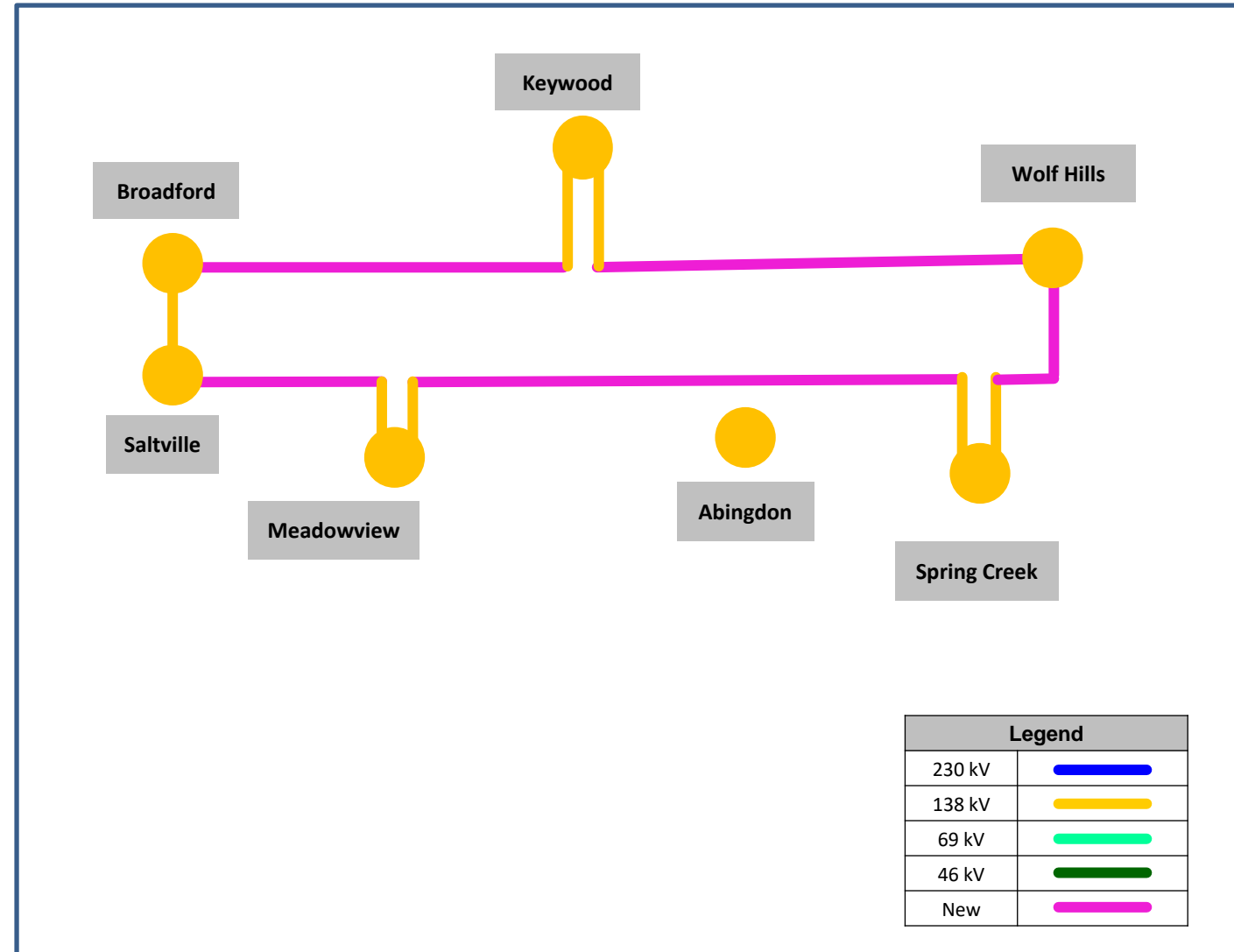

AEP Transmission Zone M-3 Process Tygart Station

Need Number: AEP-2020-AP008

Process Stage: Submission of Supplemental Project for inclusion in the Local Plan 06/15/2020

Previously Presented:

Needs Meeting 02/21/2020

Solutions Meeting 04/20/2020

Project Driver:

Customer Service

Specific Assumption Reference:

AEP Connection Requirements for the AEP Transmission System (AEP Assumptions Slide 7)

Problem Statement:

- Kentucky Power has requested a new 69kV Transmission delivery point in Siloam area with a projected load of 9 MW.

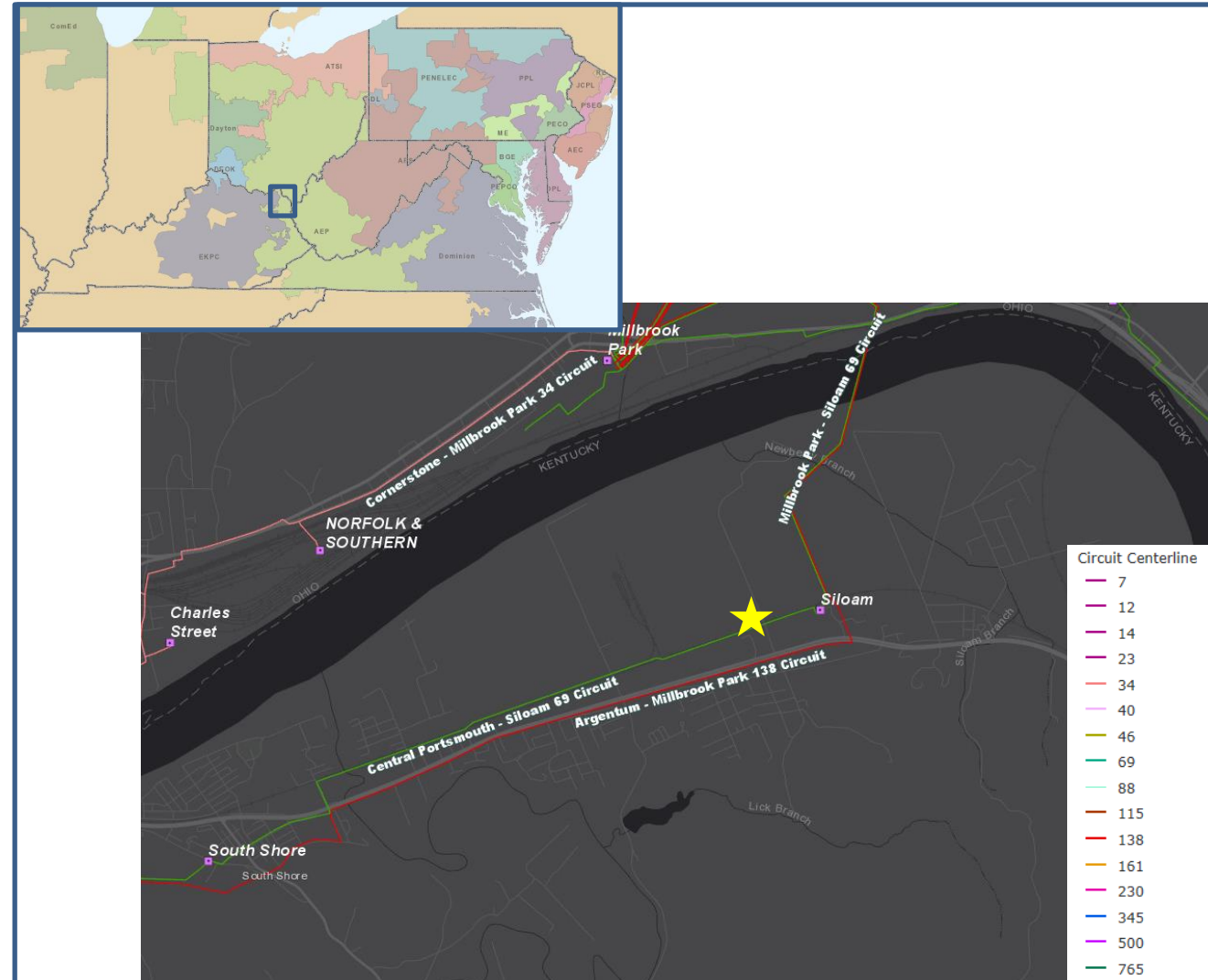

AEP Transmission Zone M-3 Process Tygart Station

Need Number: AEP-2020-AP008

Process Stage: Submission of Supplemental Project for inclusion in the Local Plan 06/15/2020

Selected Solution:

- Establish a new station (Tygart) and install a 69/12 kV 25 MVA transformer and two 69kV breakers. **(S2251.1) Estimated Cost: \$2.6M**
- Retire Siloam Station. **(S2251.2) Estimated Cost \$0M**
- Remote end relaying at Millbrook Park to coordinate with new breakers. **(S2251.3) Estimated Cost: \$0.4M**
- Tap the 69kV Central Portsmouth – Millbrook Park line and install 3 custom T-line structures due to proximity to the Railroad. **(S2251.4) Estimated Cost: \$0.9M**

Estimated Cost: \$3.9 M

Projected In-Service: 12/01/2020

Supplemental Project ID: S2251.1-4

Project Status: Engineering

Model: 2024 RTEP

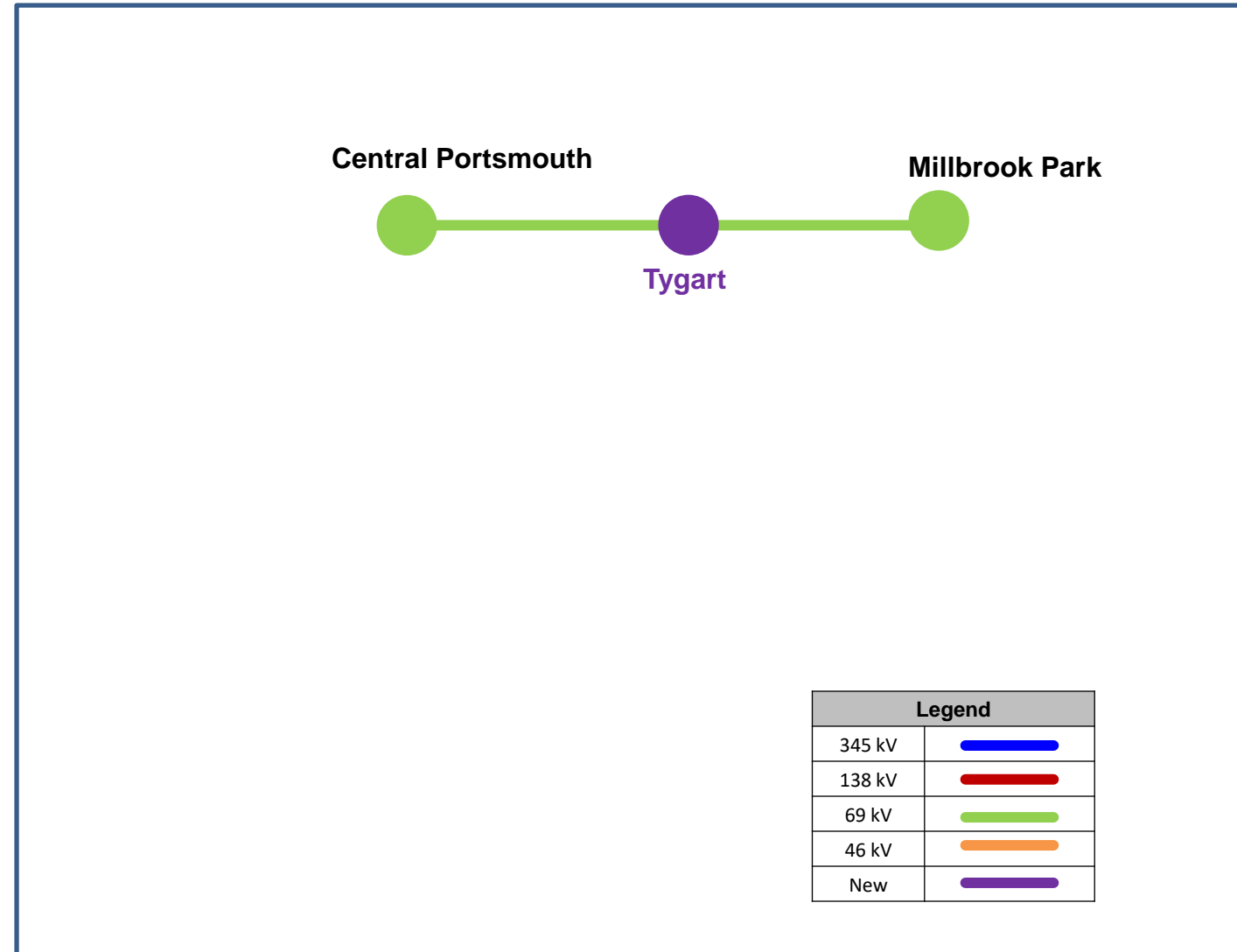

AEP Transmission Zone M-3 Process Glenmary Station

Need Number: AEP-2020-AP020

Process Stage: Submission of Supplemental Project for inclusion in the Local Plan
06/15/2020

Selected Solution:

- Establish new Glenmary 138 kV station with 2-138 kV circuit breakers and a 138/12 kV, 25 MVA transformer with high-side circuit switcher and 3 distribution feeders. (**S2252.1**) **Estimated Cost: \$0M**
- Add a tap structure to the Kumis-Cloverdale (between Matt Funk and West Salem) 138 kV line. (**S2252.2**) **Estimated Cost: \$0.8M**
- Construct ~0.5 miles of double circuit 138 kV extending from the Kumis-Cloverdale 138 kV line to the new Glenmary Station. (**S2252.3**) **Estimated Cost: \$3.1M**
- Upgrade line relay and retire wave trap on the Matt Funk Line at Cloverdale station. (**S2252.4**) **Estimated Cost: \$0.5M**
- Upgrade line relay and retire wave trap on the Cloverdale Line at Matt Funk station. (**S2252.5**) **Estimated Cost: \$0.5M**
- Install 0.2 mi of fiber for station entrances into Glenmary station. (**S2252.6**) **Estimated Cost: \$0.2M**

Ancillary Benefits: The new station will also allow for the establishment of another distribution circuit to split up an existing circuit in the area (Kumis/Glenvar 12 kV) in order to reduce exposure to over 1200 customers which experienced over 2.3 million customer minutes of interruption over the past 3 years. In addition, the new station will provide additional capacity to help restore load in the event of a station outage at Kumis.

Estimated Cost: \$5.1 M

Projected In-Service: 08/01/2021

Supplemental Project ID: S2252.1-6

Project Status: Scoping

Model: 2024 RTEP

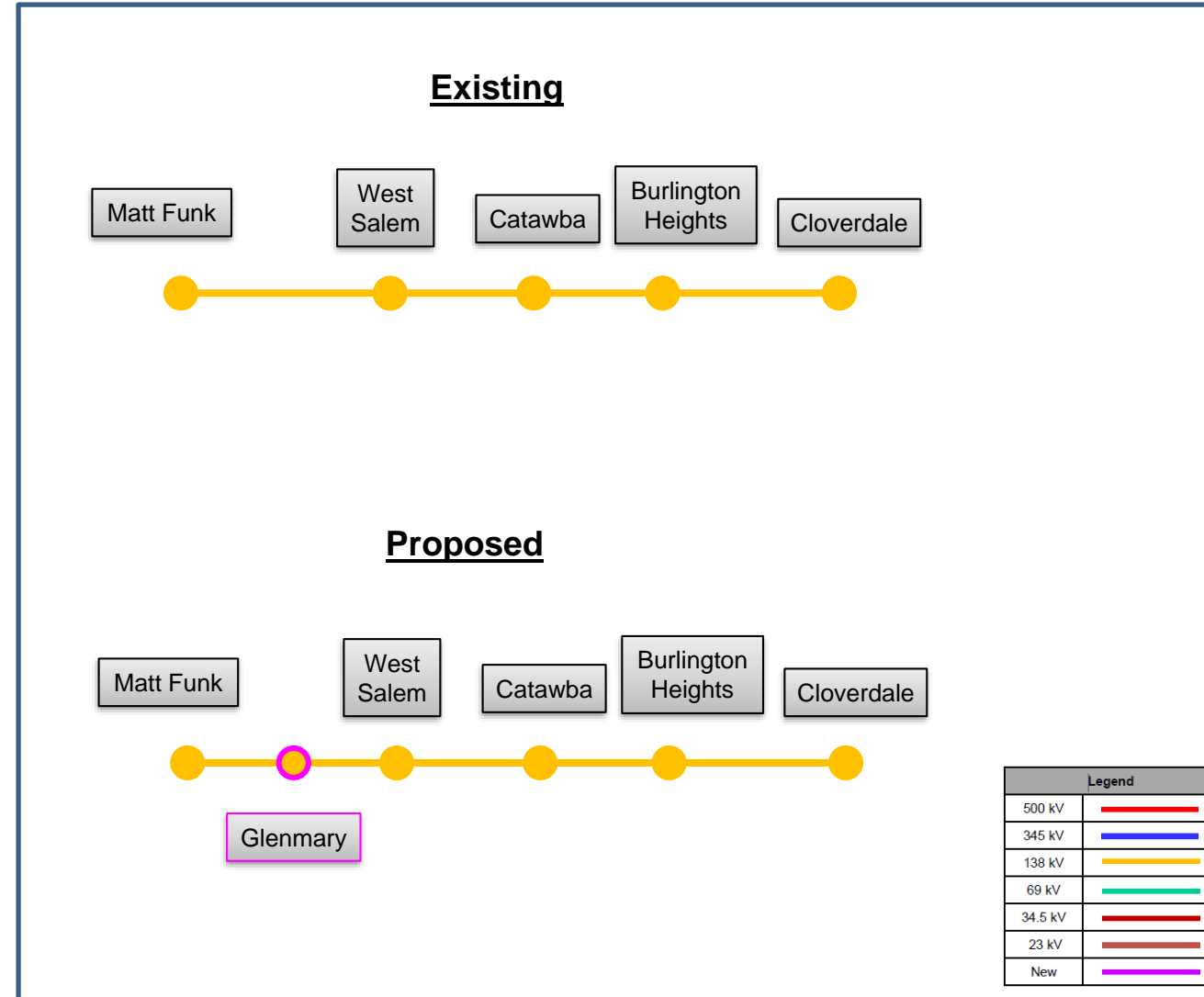

AEP Transmission Zone M-3 Process

Raccoon Station

Need Number: AEP-2020-AP022

Process Stage: Submission of Supplemental Project for inclusion in the Local Plan 06/15/2020

Previously Presented:

Needs Meeting 03/19/2020

Solutions Meeting 04/20/2020

Project Driver:

Customer Service

Specific Assumption Reference:

AEP Connection Requirements for the AEP Transmission System (AEP Assumptions Slide 7)

Problem Statement:

- AEP Kentucky Power Distribution has requested a new distribution service out of the Cedar Creek – John Creek 138kV circuit near Pikeville, Kentucky. The projected Winter peak projected load is 13 MVA.

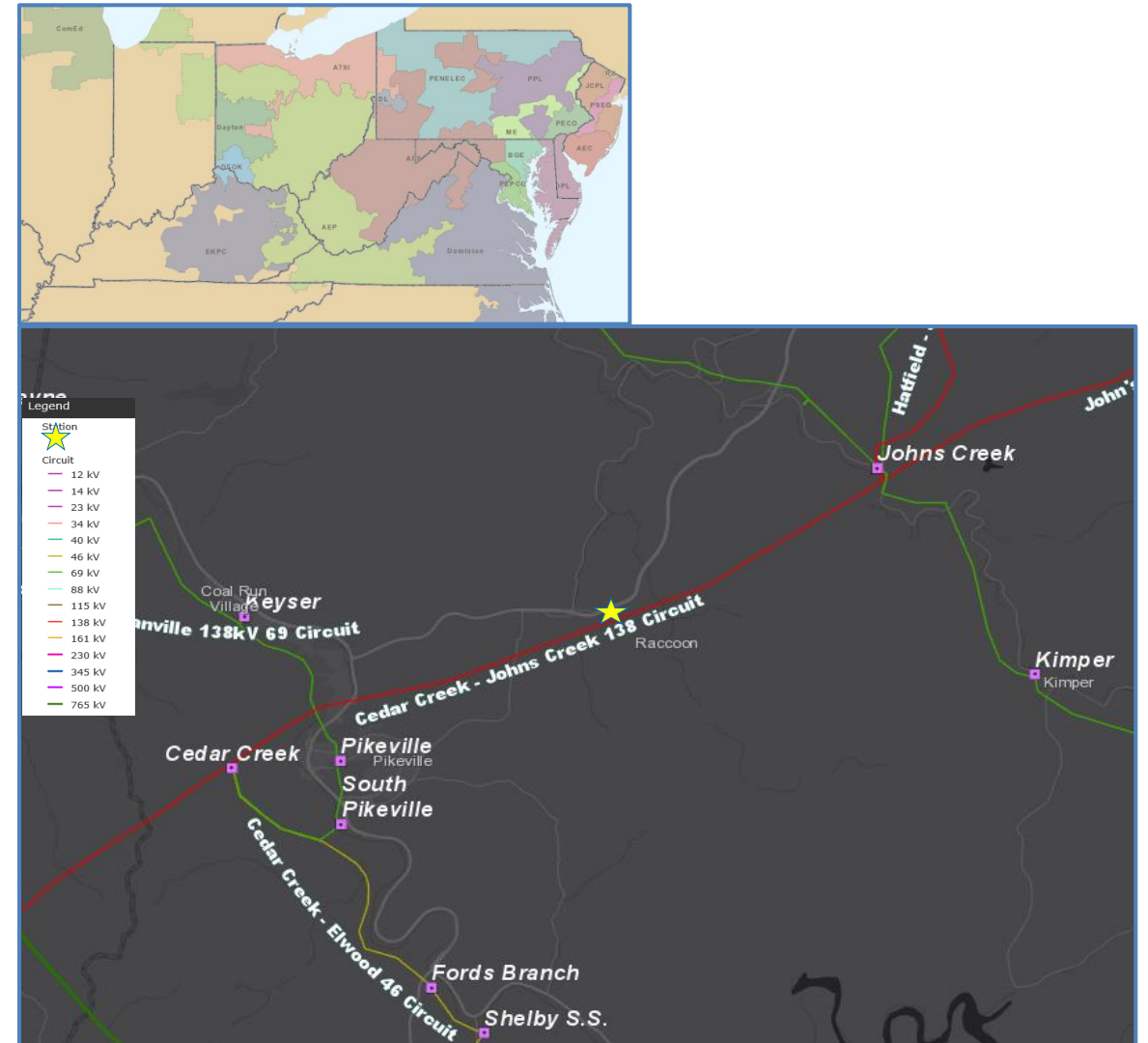

AEP Transmission Zone M-3 Process Raccoon Station

Need Number: AEP-2020-AP022

Process Stage: Submission of Supplemental Project for inclusion in the Local Plan 06/15/2020

Selected Solution:

Raccoon substation:

- Construct a new station (Raccoon) and install a 138/34.5kV 30 MVA transformer and 138 kV MOABs. (**S2253.1**)
Estimated Cost: \$0M
- Install 0.2 mi double circuit extension from the Cedar Creek – Johns Creek 138kV circuit to cut the line into Raccoon Station. (**S2253.2**) **Estimated Cost: \$1.3M**

Estimated Cost: \$1.3 M

Projected In-Service: 12/01/2020

Supplemental Project ID: S2253.1-.2

Project Status: Engineering

Model: 2024 RTEP

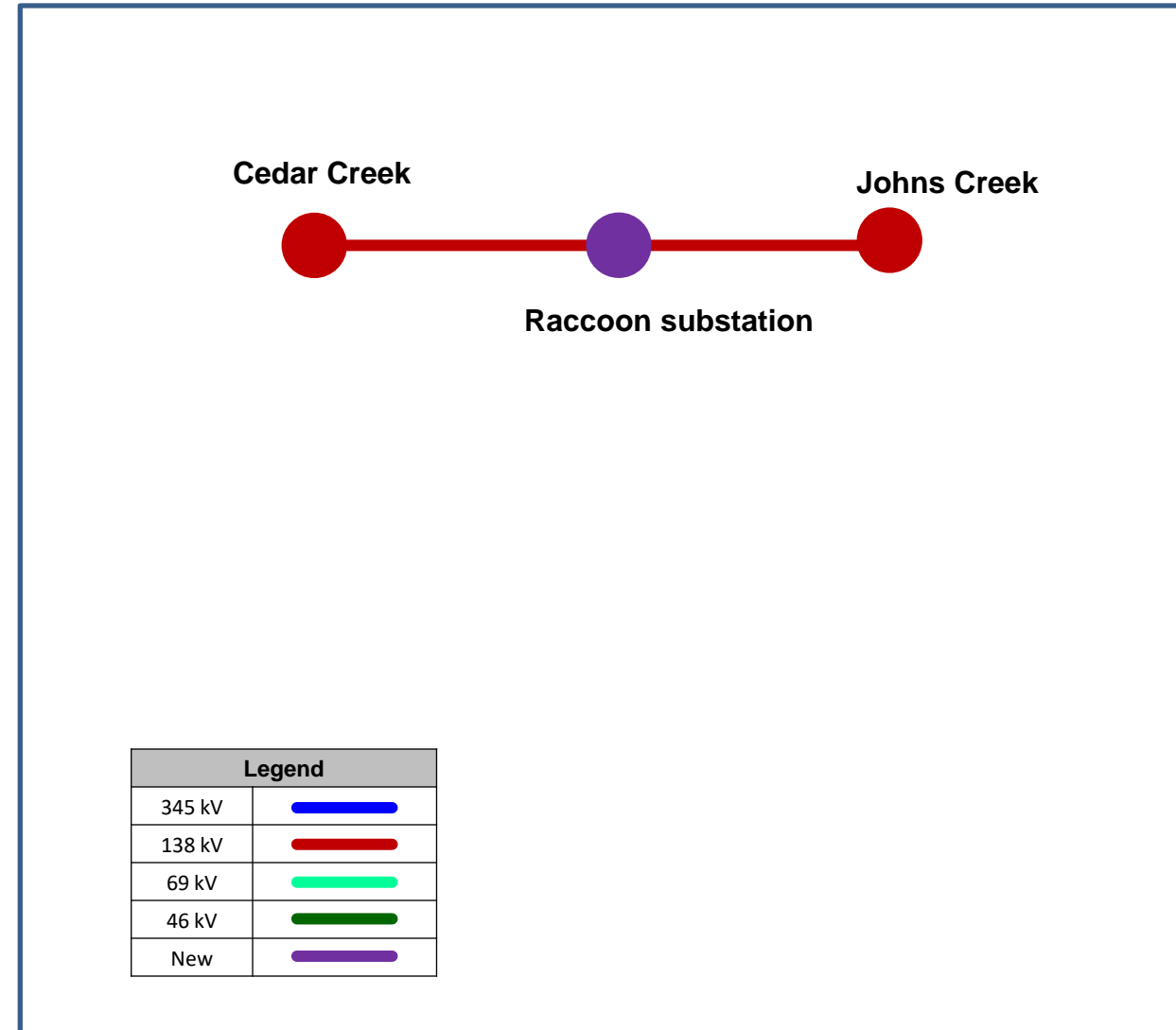

AEP Transmission Zone M-3 Process Cameron Customer Service

Need Number: AEP-2018-OH032

Process Stage: Submission of Supplemental Project for inclusion in the Local Plan
08/06/2020

Previously Presented:

Needs Meeting 1/11/2019

SRRTEP-W Solutions Meeting 2/21/2020

TEAC Meeting 3/10/2020

Solutions Meeting 05/12/2020 (2nd Review)

Project Driver:

Customer Service

Specific Assumption Reference:

AEP Connection Requirements for the AEP Transmission System (AEP Assumptions Slide 7)

Problem Statement:

A customer has requested new service west of Cameron, West Virginia. The forecasted peak demand is 30 MW initially, with long-term prospects of 90 MW.

With the addition of this customer load, plus the new customer load on S2097 (AEP-2019-OH006), the Wayman-Gosney-Nauvoo Ridge 138kV radial line has an MVA-mile demand of 4442 896, far exceeding AEP's guideline of 75 MVA-miles. The MVA-mile demand that exists today on the Wayman-Gosney Hill 138kV circuit is 313 without any new load additions. **After additional DNH study by PJM, a generation deliverability overload was found at Gosney Hill 138kV station on the Gosney Hill-Nauvoo Ridge 138 kV line for loss of the Kammer-Panhandle 500 kV line and the Kammer 765/500 kV transformer ('AEP_P1-3_#8975_05KAMMER 765_200', 'AEP_P1-2_500-1').**

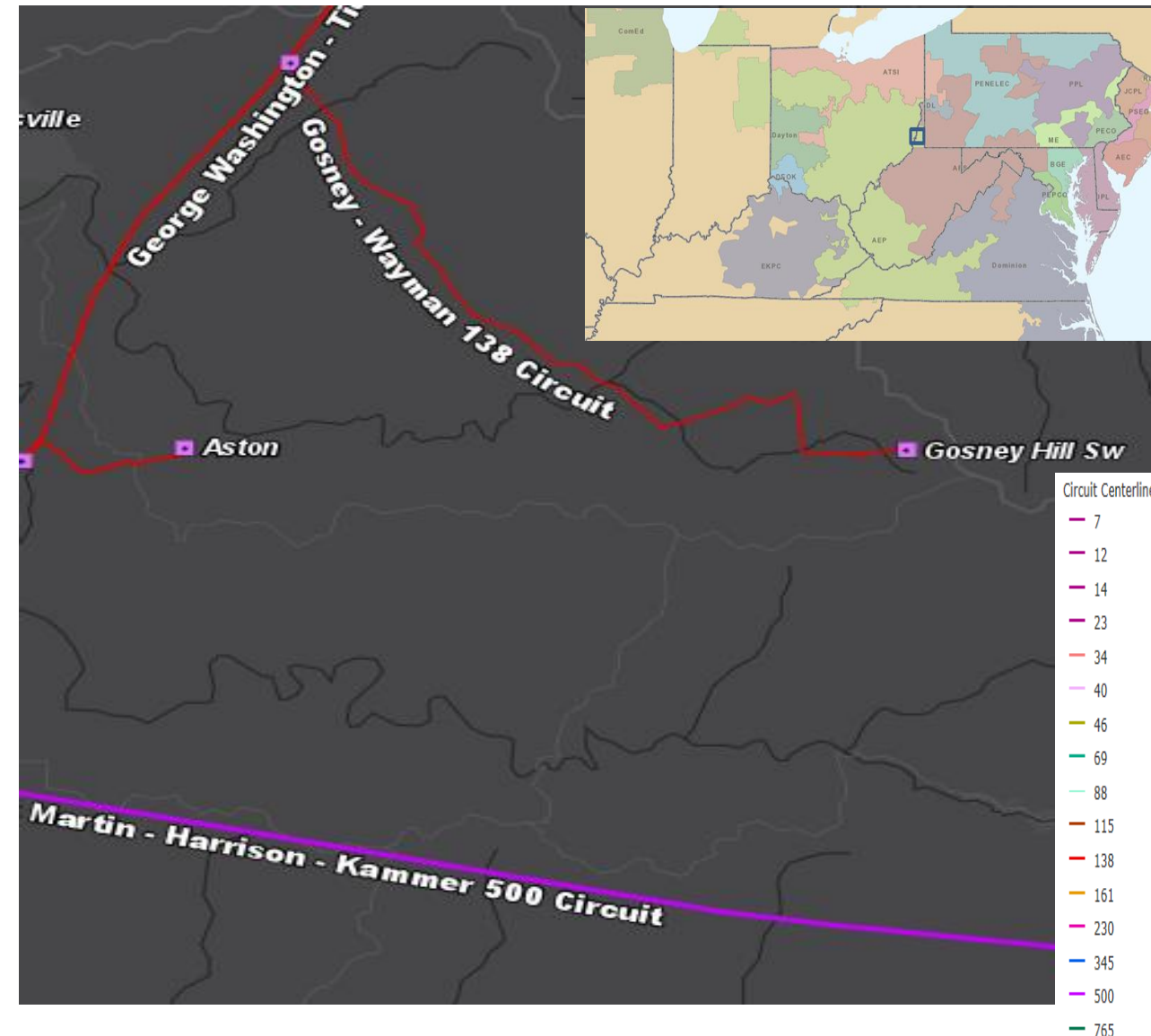

AEP Transmission Zone M-3 Process Cameron Customer Service

Need Number: AEP-2018-OH032

Process Stage: Submission of Supplemental Project for inclusion in the Local Plan 08/06/2020

Selected Solution:

Construct a new 500-138kV station (Panhandle), connecting to the Kammer-502 Junction 500kV circuit (~10.3 miles from Kammer, 31.7 miles from 502 Junction). Install a 3-breaker 500kV ring bus; 450 MVA 500-138kV transformer; 3-breaker 138kV ring bus. **(S2270.1)**

Estimated Cost: \$25.0 M

Construct a new 138kV switching station (Nauvoo Ridge) with 8- 138kV breakers in a breaker-and-a-half design. The station will have 1 circuit to Gosney Hill, 2 circuits to the customer's facility, 2 circuits to Panhandle, and a 23 MVAR 138kV cap bank. **(S2270.2) Estimated Cost: \$16.4 M**

At Gosney Hill, install a new 138kV breaker toward Nauvoo Ridge. Update station protection. **Replace the 795 kcmil AAC risers and strain bus with 2000 kcmil AAC risers. (S2270.3) Estimated Cost: \$1.3 M**

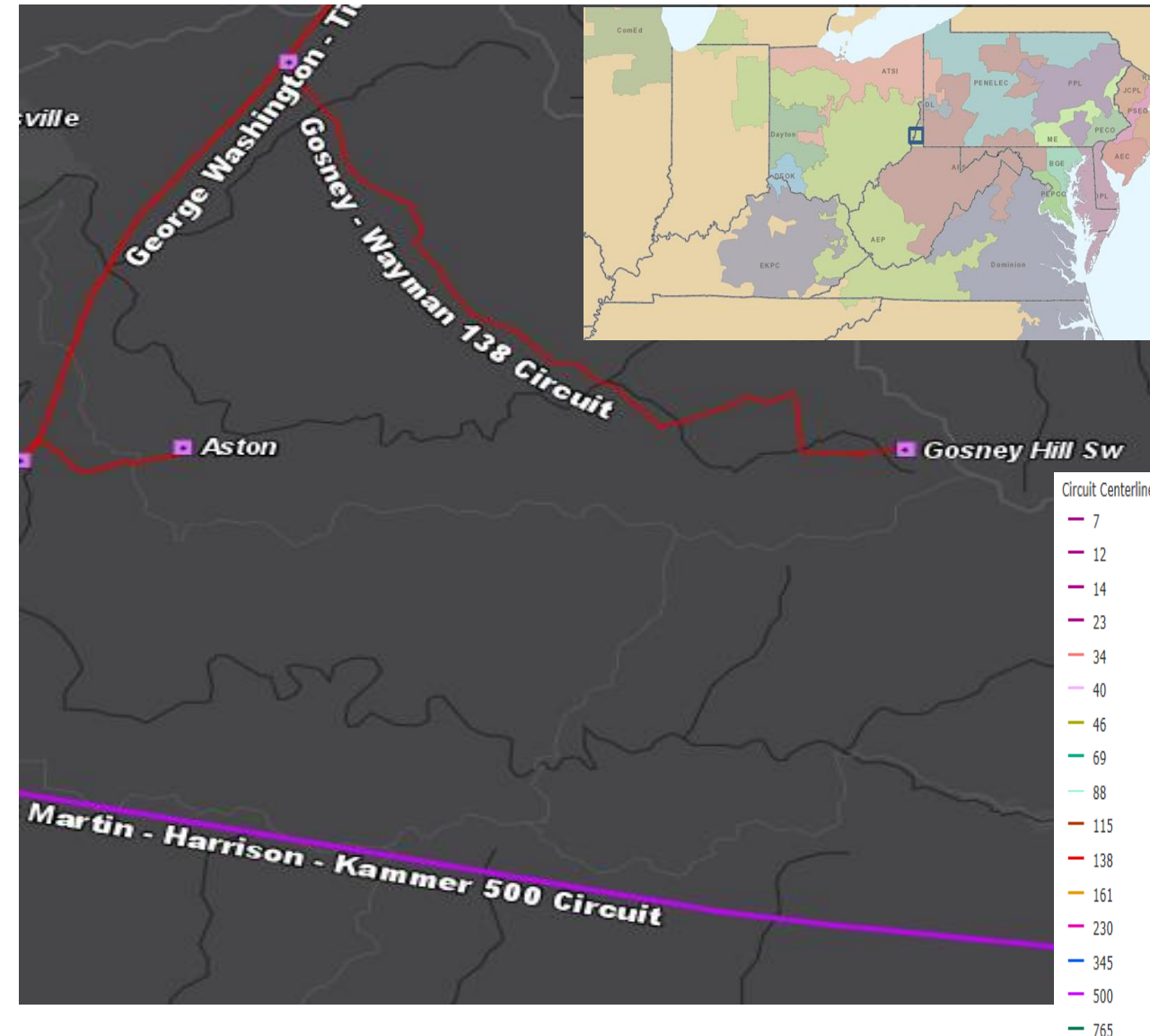

AEP Transmission Zone M-3 Process Cameron Customer Service

Need Number: AEP-2018-OH032

Process Stage: Submission of Supplemental Project for inclusion in the Local Plan 08/06/2020

Selected Solution Continued:

Construct a new 4.7-mile 138kV line south of Gosney Hill station to Nauvoo Ridge. Utilize 1033 ACSR conductor. Acquire new right-of-way. **(S2270.4) Estimated Cost: \$14.7 M**

Construct a new 1.3 mile double-circuit 138kV line from Nauvoo Ridge to the customer's substation. Acquire new right-of-way. **(S2270.5) Estimated Cost: \$4.8 M**

Construct a new 1.5 mile double-circuit 138kV line from Panhandle to Nauvoo Ridge. Utilize 1033 ACSR conductor for each circuit. Acquire new right-of-way. **(S2270.6) Estimated Cost: \$5.0 M**

Extend the Kammer-502 Junction 500kV transmission line 0.1-mile into Panhandle station (0.2 mile total). **(S2270.7) Estimated Cost: \$1.5 M**
Estimated Cost: \$68.7 M

Projected In-Service: 7/21/2020 (for initial 138kV service to the customer). 3/1/2022 (for the 2nd phase to construct Panhandle station and complete the 138kV loop).

Supplemental Project ID: S2270.1-7

Project Status: Engineering (for initial customer service project); Scoping (for 2nd phase)

Model: Summer RTEP 2024

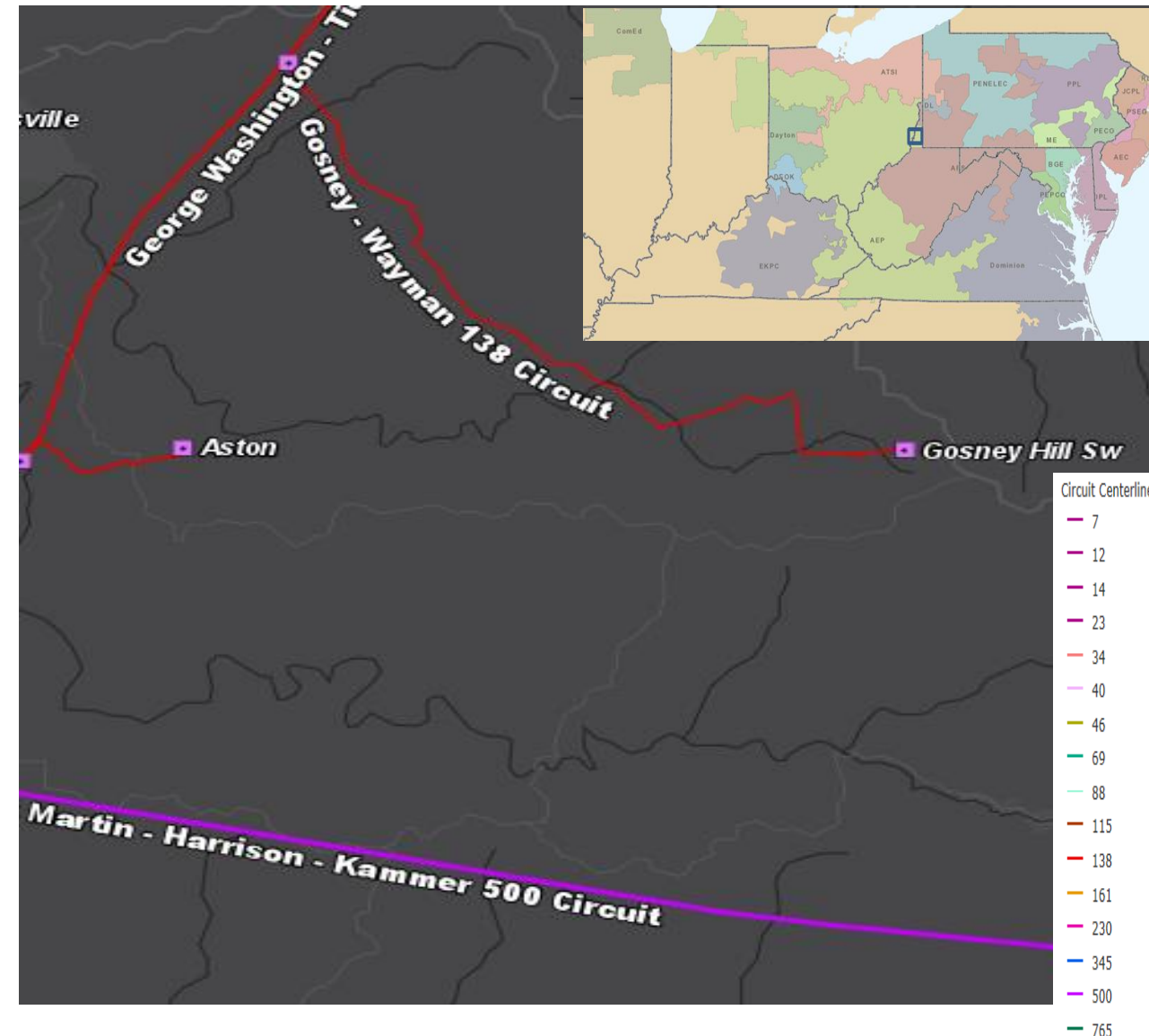

AEP Transmission Zone M-3 Process Cameron Customer Service

Need Number: AEP-2018-OH032

Process Stage: TEAC Solutions Meeting 05/12/2020

Proposed Solution:

Legend	
500 kV	
345 kV	
138 kV	
69 kV	
34.5 kV	
23 kV	
New	

Existing:

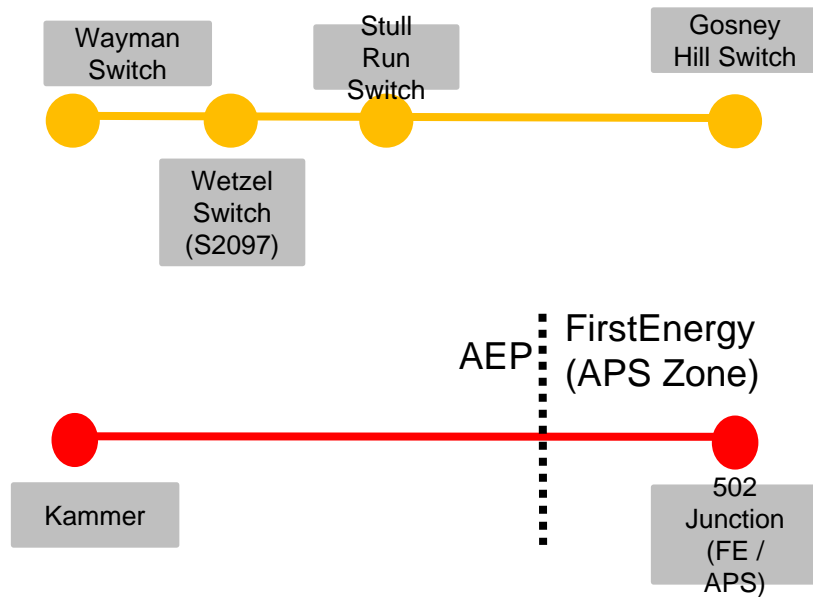

Proposed:

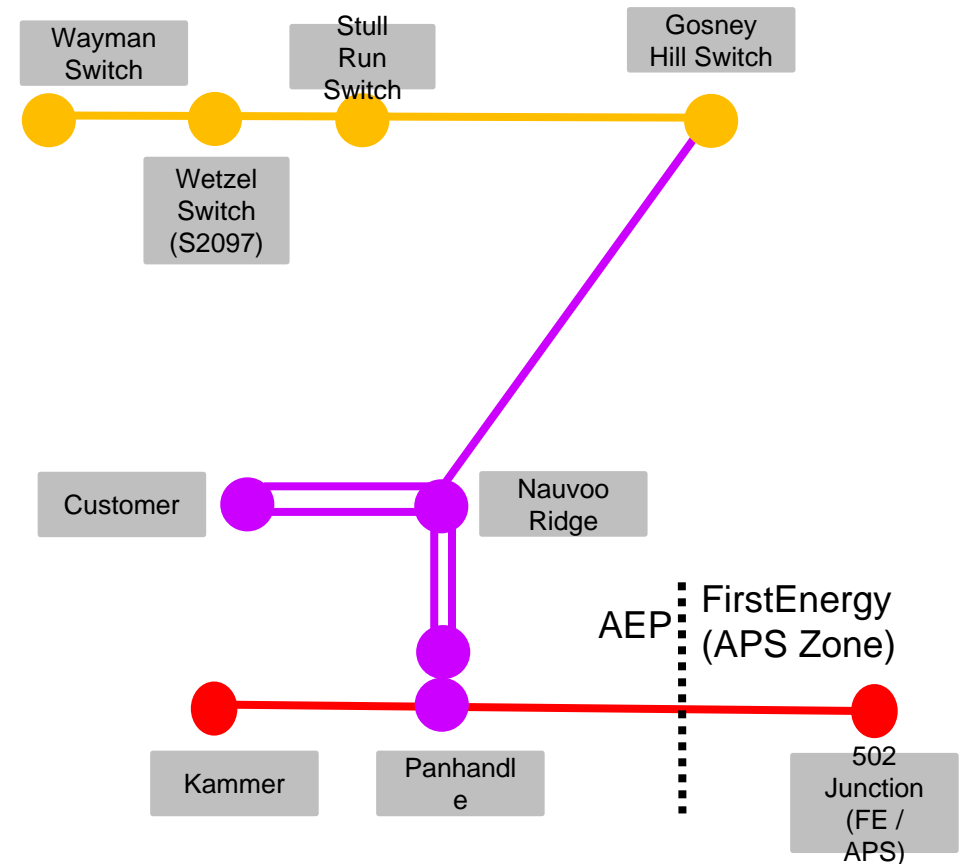

AEP Transmission Zone M-3 Process Walhonding

Need Number: AEP-2018-OH035

Process Stage: Submission of Supplemental Project for inclusion in the Local Plan 08/06/2020

Previously Presented:

Need Meeting 11/22/2019

Solutions Meeting 05/22/2020

Project Driver:

Customer Service

Specific Assumption Reference:

AEP Connection Requirements for the AEP Transmission System (AEP Assumptions Slide 7)

Problem Statement:

A recent customer service request of 2.5 MW has been made on the Killbuck – South Coshocton 34.5 kV circuit.

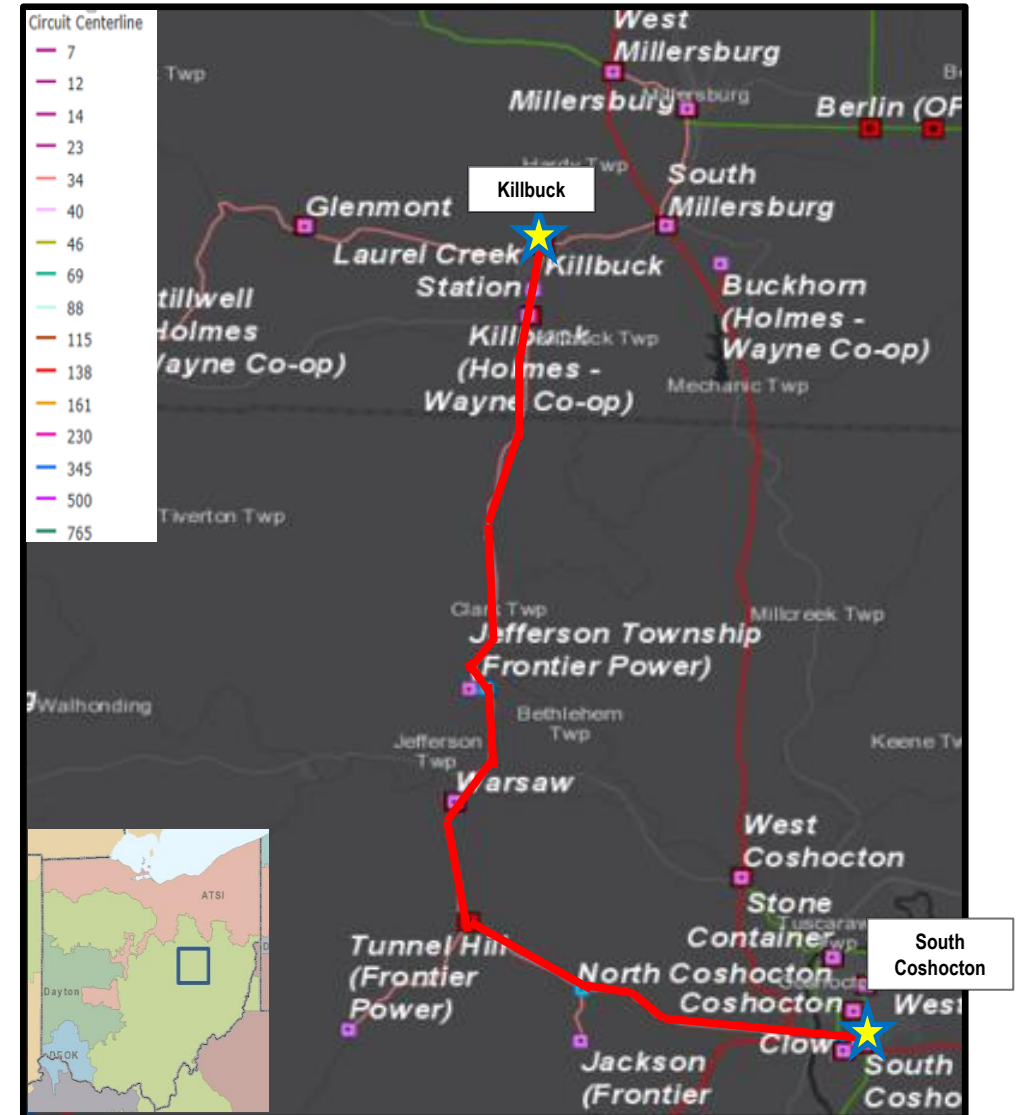

AEP Transmission Zone M-3 Process Walhonding

Need Number: AEP-2018-OH035

Process Stage: Submission of Supplemental Project for inclusion in the Local Plan 08/06/2020

Selected Solution:

Walhonding Switch and the Walhonding Extension will be built at 69 kV design but will operate at 34.5 kV until project S2149 is in service, at which time it will operate at 69 kV.

- Install approximately 1 mile of double circuit line to tie the greenfield Walhonding Switch to the Killbuck – South Coshocton 34.5kV circuit. (**S2271.1**) **Estimated Cost: \$3.2M**
- Install approximately 0.01 mile radial line extension, connecting Marathon’s station to Walhonding switch. (**S2271.2**) **Estimated Cost: \$0.1M**
- Install a new 3-way 69 kV 1200A switch with Auto-Sectionalizing, MOABs, and SCADA to serve the new customer. (**S2271.3**) **Estimated Cost: \$1.0M**

Estimated Cost: \$4.3M

Projected In-Service: 04/01/2021

Supplemental Project ID: S2271.1-.3

Project Status: Engineering

Model: 2024 RTEP

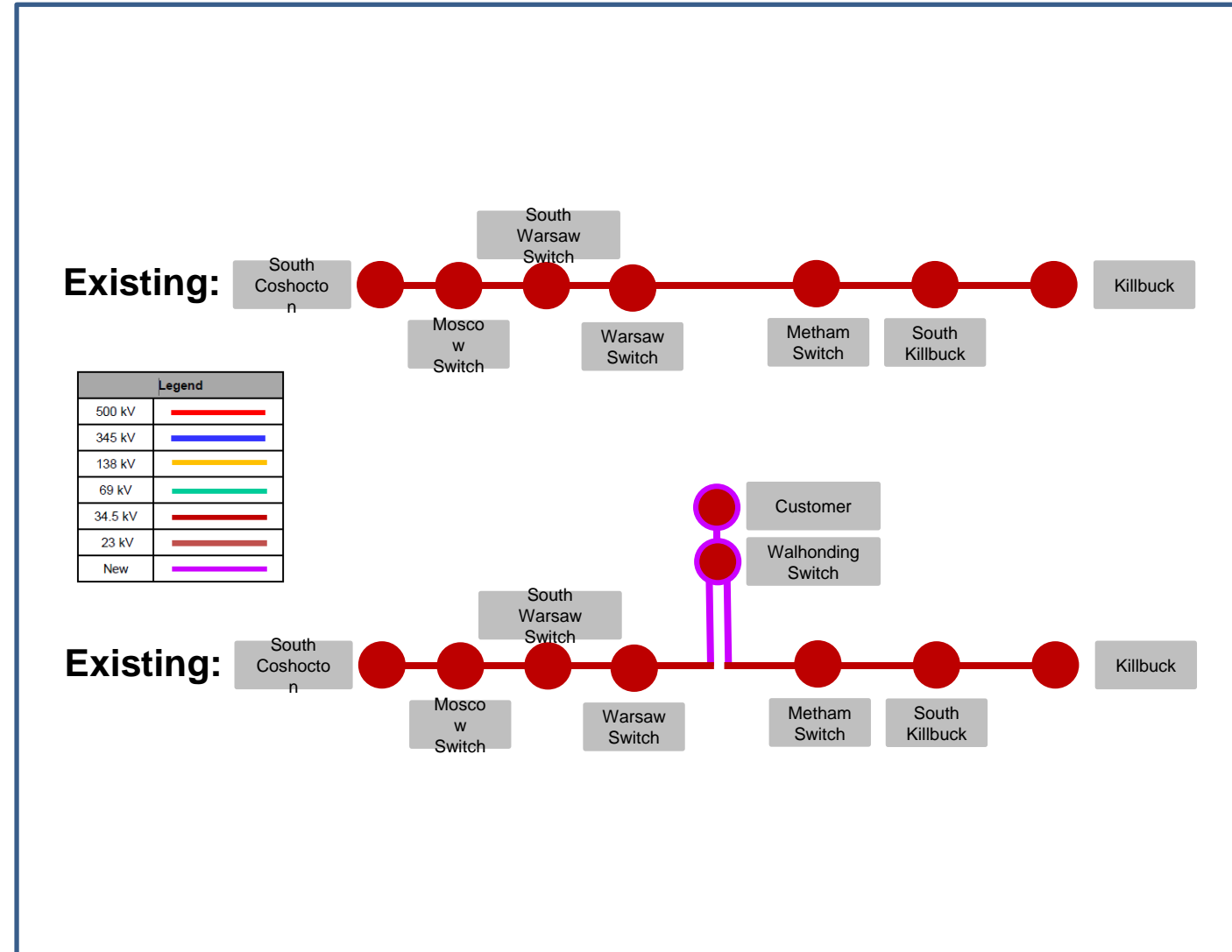

AEP Transmission Zone M-3 Process

Millbrook Park-South Point Rebuild

Need Number: AEP-2019-OH025

Process Stage: Submission of Supplemental Project for inclusion in the Local Plan 08/06/2020

Previously Presented:

Needs Meeting 05/20/2019

Solutions Meeting 05/22/2020

Project Driver:

Equipment/Material/Performance/Risk

Specific Assumption Reference:

AEP Guidelines for Transmission Owner Identified Needs (AEP Assumptions Slide 8), Presentation on pre-1930s lines

Problem Statement:

- The South Point – Portsmouth 138 kV double circuit is 34.7 miles and the Bellefonte 138 kV Extension is 4 miles in length.
- The conductor is primarily 397.5 ACSR (167 MVA).
- The South Point-Portsmouth line was originally constructed in 1929, with the majority of the structures and conductor being original.
- There are 45 open conditions on the line, including conductor issues, burnt/broken insulators, and loose/broken conductor hardware.
- Insulators of this vintage have shown heightened failure rates.

In general, several issues impact 1920 lattice tower lines:

- The steel conductor attachment plates have significant wear resulting in a loss of 50% of its strength.
- The cross arm hanger tension members are single mode of failure elements that are deteriorated and undersized due to the original design criteria.
- Lattice towers of this vintage do not meet current design requirements for wind and ice loading.
- Foundations are undersized for modern wind loading.
- Towers are beginning to show corrosion.

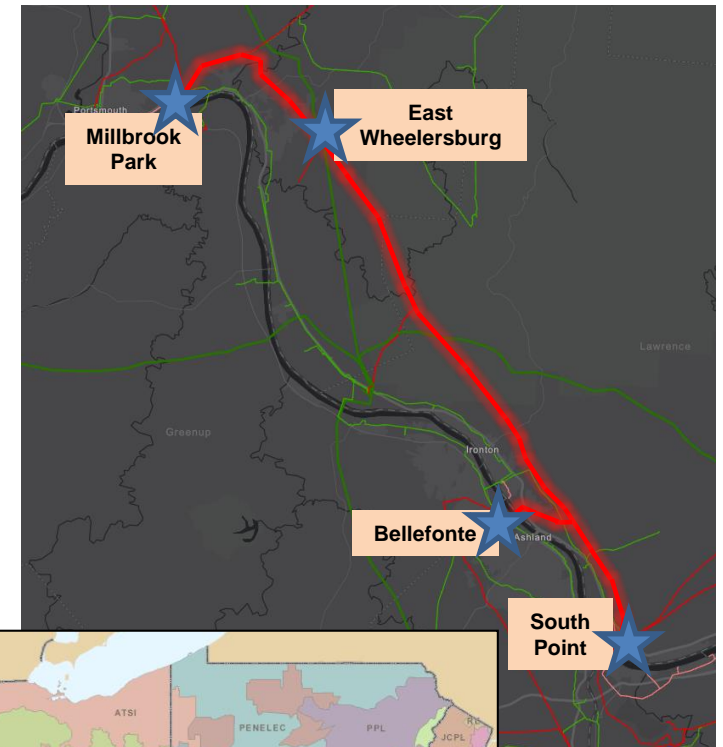
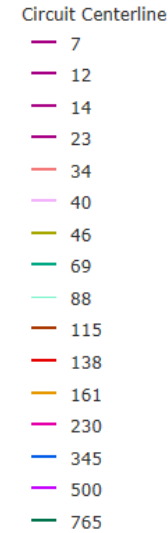

AEP Transmission Zone M-3 Process Millbrook Park-South Point Rebuild

Need Number: AEP-2019-OH025

Process Stage: Submission of Supplemental Project for inclusion in the Local Plan 08/06/2020

Selected Solution:

Rebuild the 35-miles of the South Point- Portsmouth double circuit 138 kV line between Millbrook Park – South Point; with 795 ACSR (257MVA) or equivalent conductor. **(S2272.1) Estimated Cost: \$128.0M**

Rebuild the 3.8-miles of the Bellefonte Extension Line from the South Point – Portsmouth line to Bellefonte; with 795 ACSR (257MVA) or equivalent conductor. **(S2272.2) Estimated Cost: \$20.1M**

Remote end work at South Point station. **(S2272.3) Estimated Cost: \$0.6M**

Estimated Cost: \$148.7M

Projected In-Service: 12/15/2025

Supplemental Project ID: S2272.1-3

Project Status: Scoping

Model: N/A

Existing:

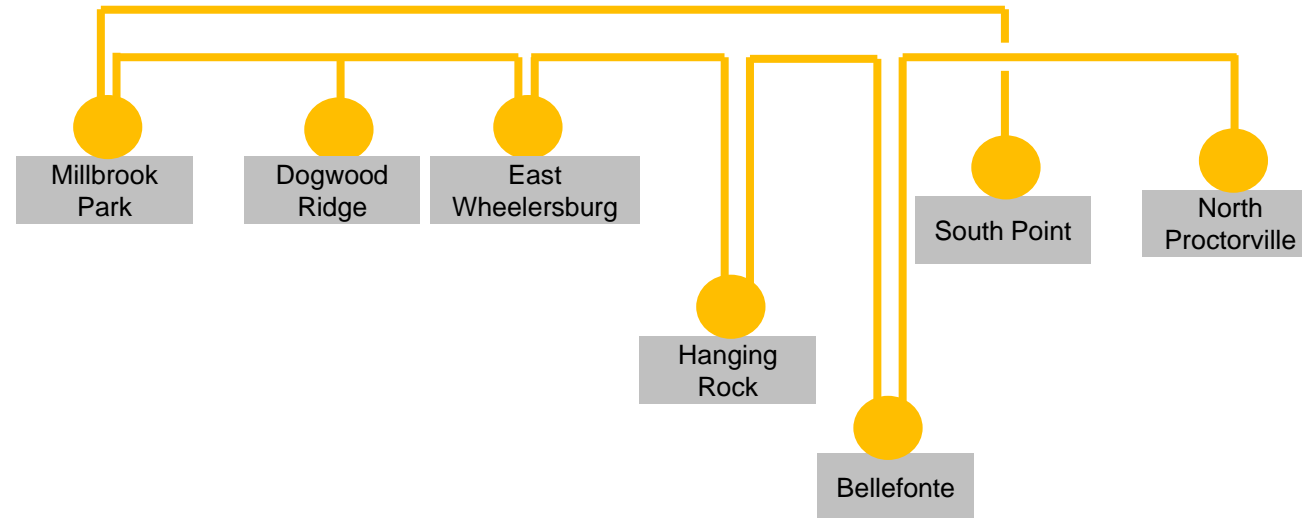

Proposed:

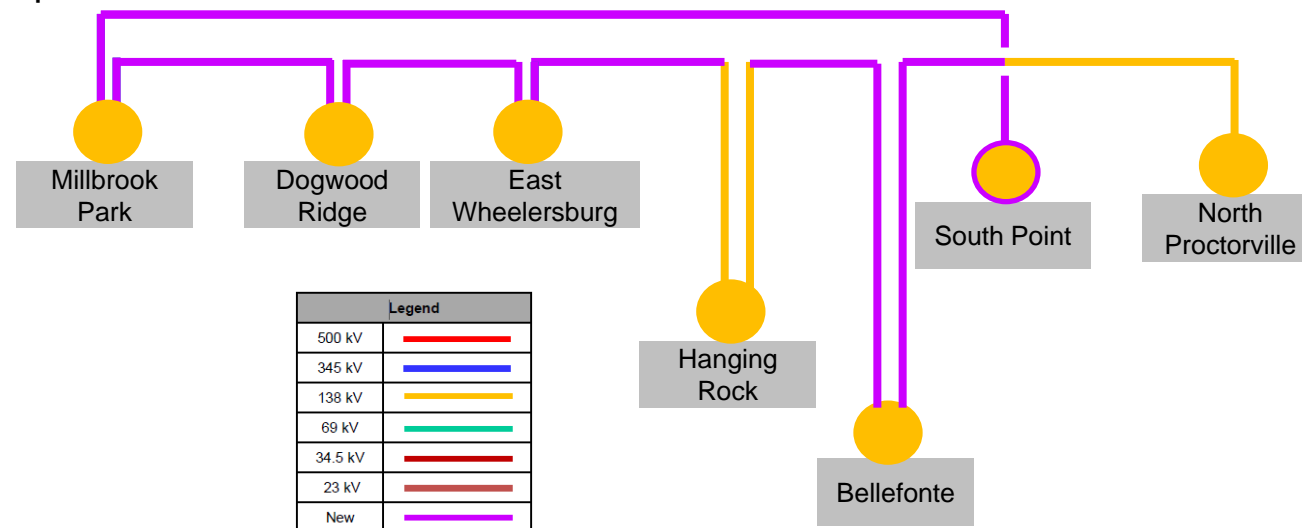

AEP Transmission Zone M-3 Process Winchester Area Improvements Supplemental

Need Number: AEP-2020-IM004

Process Stage: Submission of Supplemental Project for inclusion in the Local Plan 08/06/2020

Previously Presented:

- Needs Meeting 02/21/2020
- Solutions Meeting 05/22/2020

Project Driver:

Equipment Material/Condition/Performance/Risk

Specific Assumption Reference:

AEP Guidelines for Transmission Owner Identified Needs (AEP Assumptions Slide 8)

Problem Statement:

Anchor Hocking – Winchester 69kV Line (~1.25 Miles)

- 1968 vintage wood pole, crossarm construction
- There are currently 12 open conditions on this line (11 structures with at least one open condition or 25% of the line).
- Open conditions include: Damaged pole, worn shield wires, stolen ground lead wires, and damaged jumpers.

Anchor Hocking 69kV station

- Breaker B 69kV
 - 1972 vintage oil filled, CF-type breaker. This type is oil filled without oil containment. Oil filled breakers have much more maintenance required due to oil handling that their modern, vacuum counterparts do not require. Finding spare parts for these units not possible as these models are no longer vendor supported

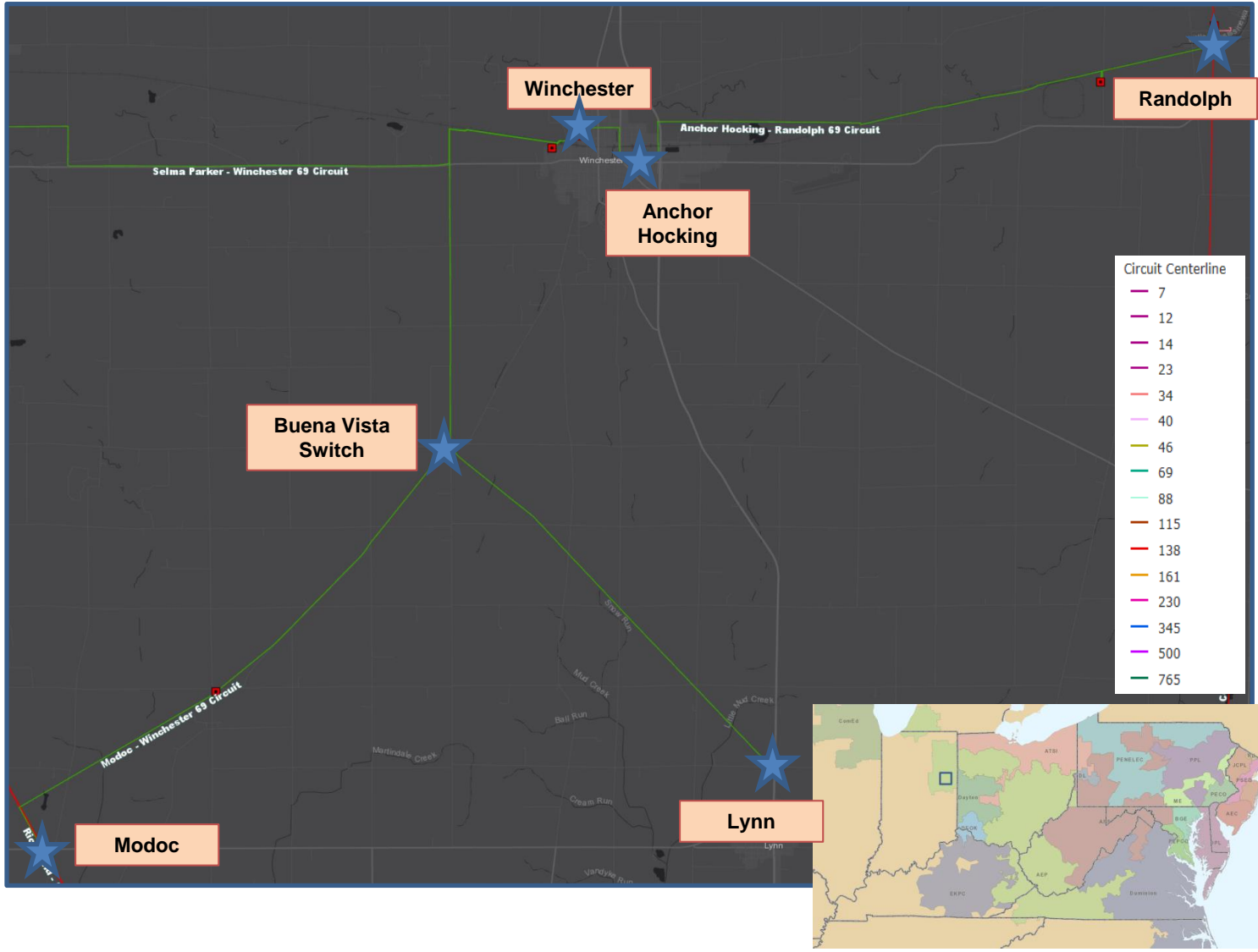

AEP Transmission Zone M-3 Process Winchester Area Improvements Supplemental

Need Number: AEP-2020-IM004

Process Stage: Submission of Supplemental Project for inclusion in the Local Plan 08/06/2020

Previously Presented:

- Needs Meeting 02/21/2020
- Solutions Meeting 05/22/2020

Project Driver:

Equipment Material/Condition/Performance/Risk

Specific Assumption Reference:

AEP Guidelines for Transmission Owner Identified Needs (AEP Assumptions Slide 8)

Problem Statement:

Winchester 69kV station

- Breakers A and B 69kV
 - 1971 vintage oil filled, CF-type breaker. This type is oil filled without oil containment. Oil filled breakers have much more maintenance required due to oil handling that modern, vacuum counterparts do not require. Finding spare parts for these units not possible as these models are no longer vendor supported. Also, oil spills can result in significant cost to mitigate

Modoc 138/69/12kV station

- 138/69kV Transformer #1
 - 1965 vintage
 - Elevated moisture levels
 - Decrease in interfacial tension of the oil, reducing its insulating capabilities
 - Unit is showing signs of leaking

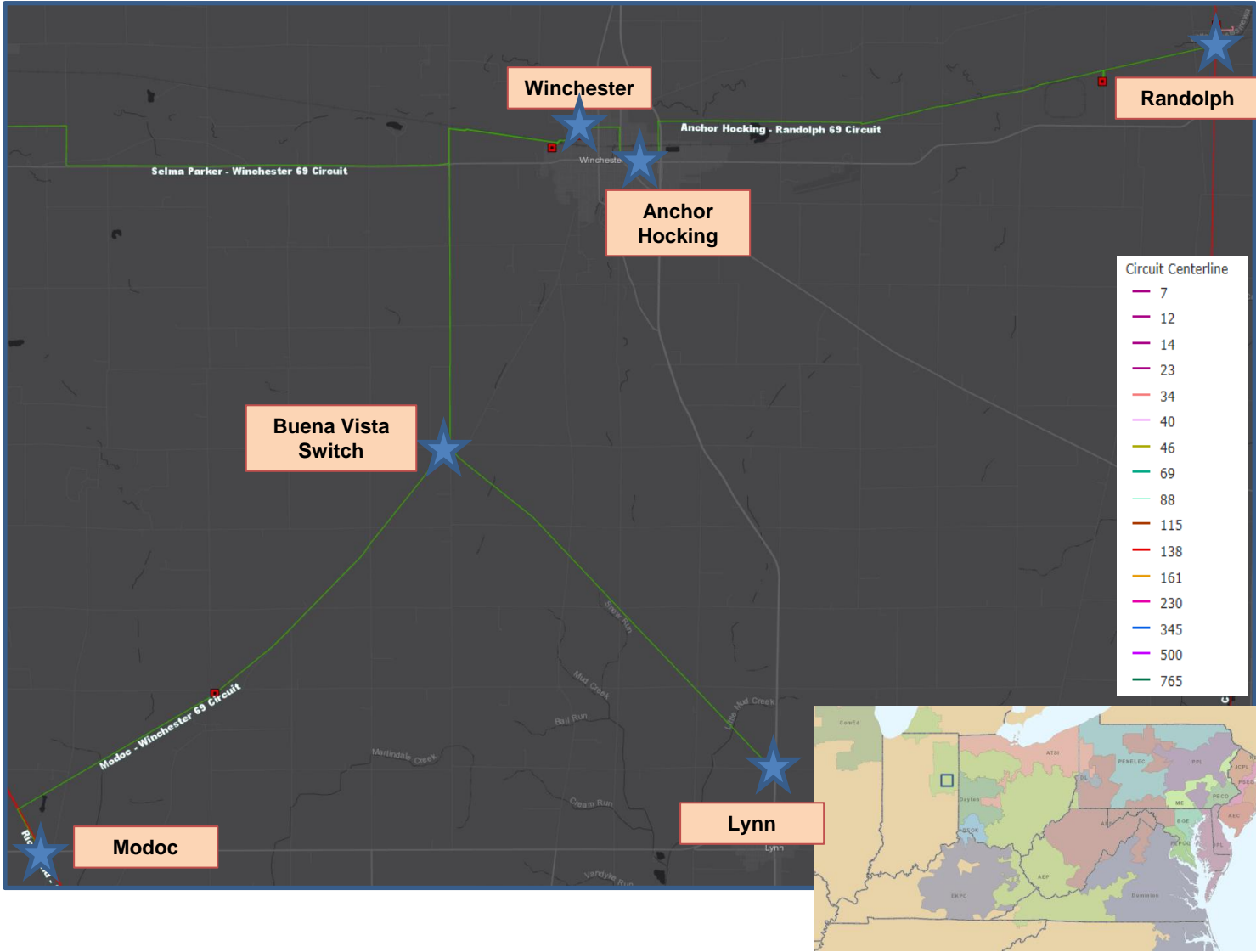

AEP Transmission Zone M-3 Process Winchester Area Improvements Supplemental

Need Number: AEP-2020-IM004

Process Stage: Submission of Supplemental Project for inclusion in the Local Plan 08/06/2020

Previously Presented:

- Needs Meeting 02/21/2020
- Solutions Meeting 05/22/2020

Project Driver:

Equipment Material/Condition/Performance/Risk

Specific Assumption Reference:

AEP Guidelines for Transmission Owner Identified Needs (AEP Assumptions Slide 8)

Problem Statement:

Randolph 138/69kV station

- 138/69/12 kV Transformer #1
 - 1970 vintage
 - Elevated carbon dioxide levels
 - Increased levels of decomposition of the paper insulating materials, leading to increased risk of failure
- Switcher V 138kV
 - Mark V S&C Electric type switcher
 - Failed operational components including high contact resistance, gas loss, and interrupter failure represent half of these malfunctions.
 - This model has no gas monitor and a history of malfunction
- Cap Switcher AA
 - 2030-69 S&C Electric type switcher.
 - This model has no gas monitor and a history of malfunction.
 - This particular switcher has exceeded the recommended number of switched operations with 5497 (5000 recommended)

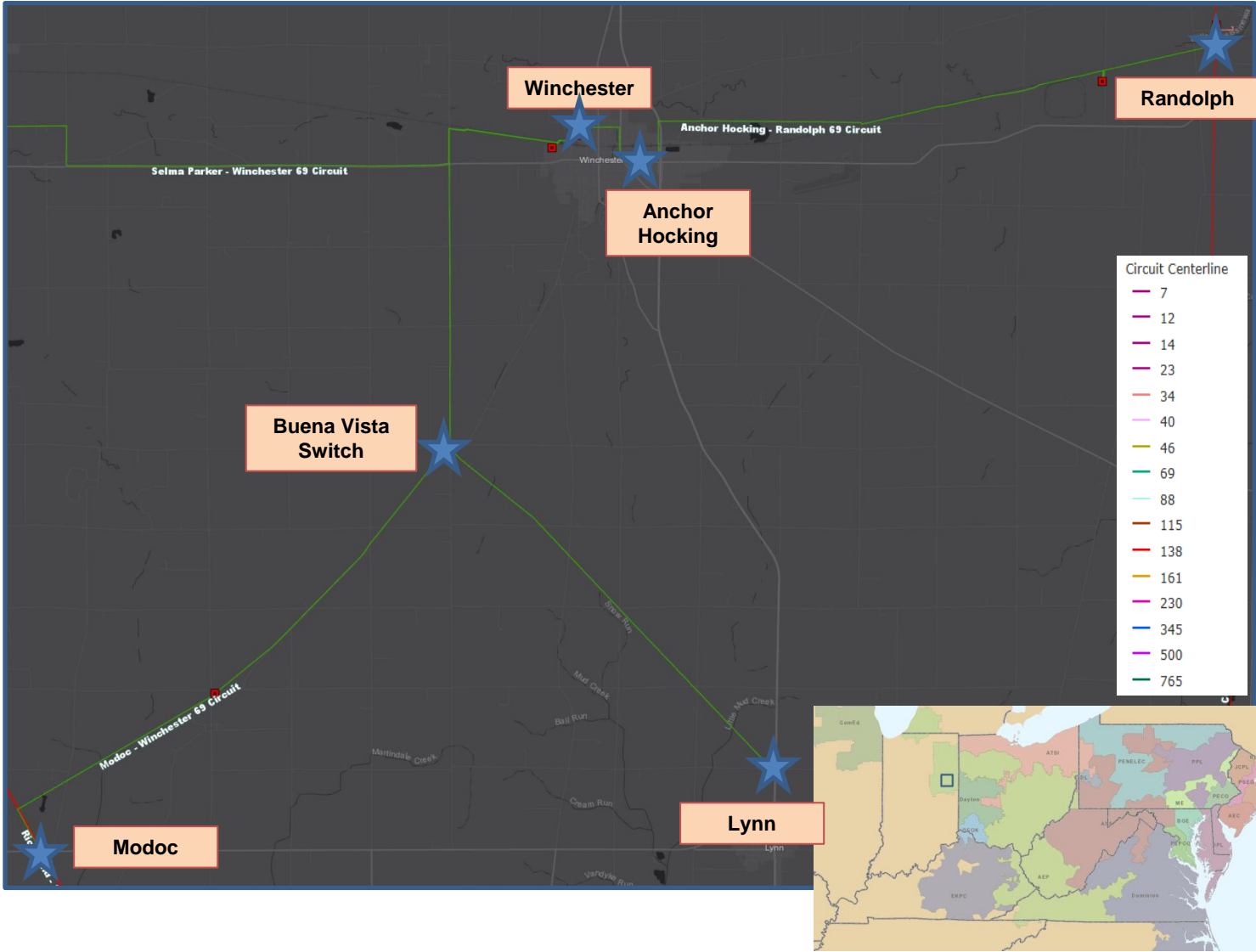

AEP Transmission Zone M-3 Process Winchester Area Improvements Supplemental

Need Number: AEP-2020-IM004

Process Stage: Submission of Supplemental Project for inclusion in the Local Plan 08/06/2020

Previously Presented:

- Needs Meeting 02/21/2020
- Solutions Meeting 05/22/2020

Project Driver:

Equipment Material/Condition/Performance/Risk

Specific Assumption Reference:

AEP Guidelines for Transmission Owner Identified Needs (AEP Assumptions Slide 8)

Problem Statement:

Modoc – Winchester 69kV Line (~13.4 Miles)

- 1967 vintage wood pole, horizontal insulator line
- There are currently 69 open conditions on this line (63 structures with at least one open condition or 26% of the line).
- Open conditions include: Damaged poles, damaged braces, broken guy wires, and damaged insulators.

Buena Vista – Lynn 69kV Line (~5.7 Miles)

- 1967 vintage wood pole, horizontal insulator line
- There are currently 31 open conditions on this line (28 structures with at least one open condition or 38% of the line).
- Open conditions include: Damaged poles, damaged shield wires, broken ground lead wires, and damaged insulators.

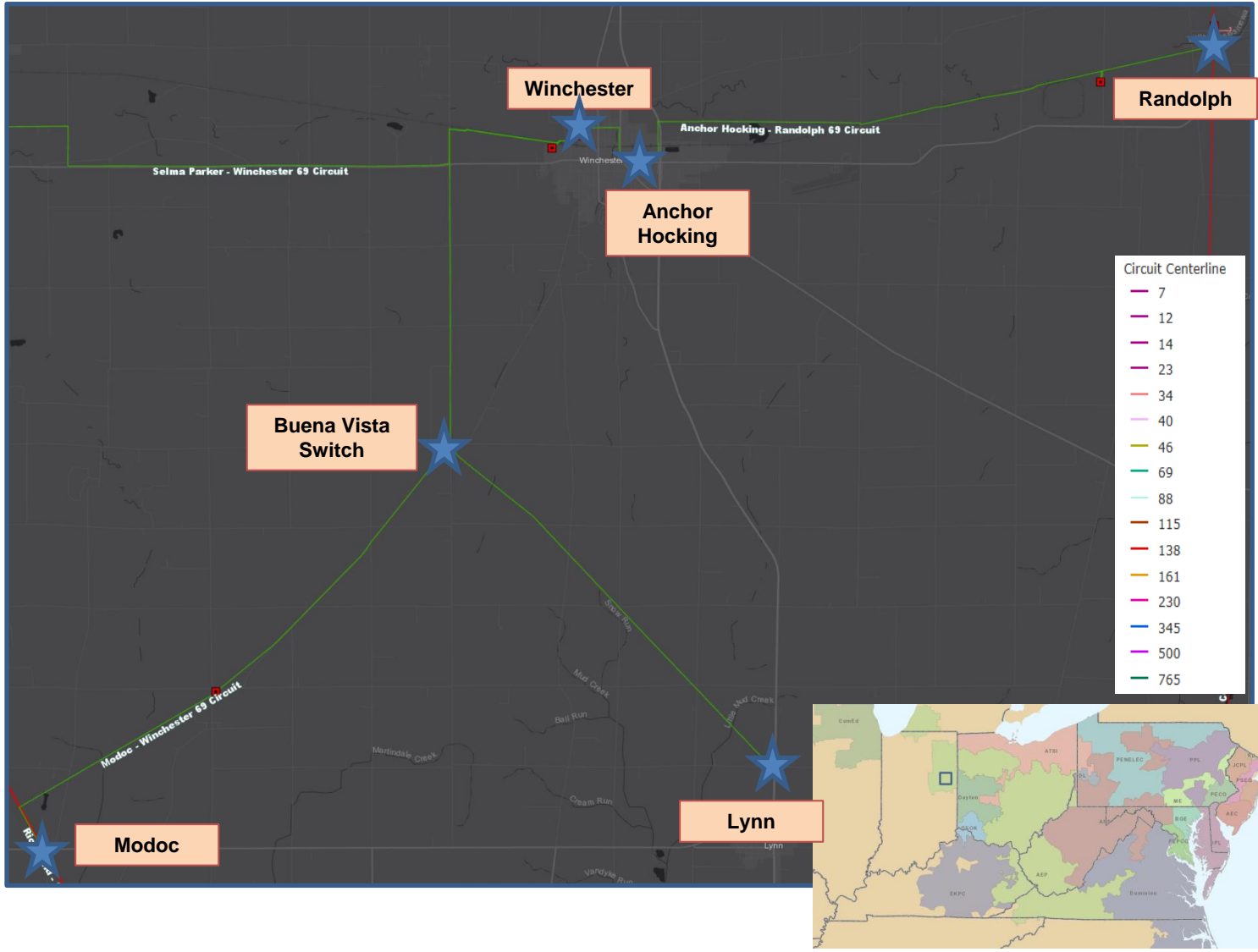

AEP Transmission Zone M-3 Process Winchester Area Improvements Supplemental

Need Number: AEP-2020-IM004

Process Stage: Submission of Supplemental Project for inclusion in the Local Plan 08/06/2020

Previously Presented:

- Needs Meeting 02/21/2020
- Solutions Meeting 05/22/2020

Project Driver:

Operational Flexibility

Specific Assumption Reference:

AEP Guidelines for Transmission Owner Identified Needs (AEP Assumptions Slide 8)

Problem Statement:

- Lynn 69/12kV station
 - Radial circuit serving 7MW peak load to REMC and the distribution network for the city of Lynn.
- Modoc 138/69/12kV station
 - Modoc is a 3 terminal line off of the Desoto – College Corner 138kV circuit with high speed ground switch protection on the transformer

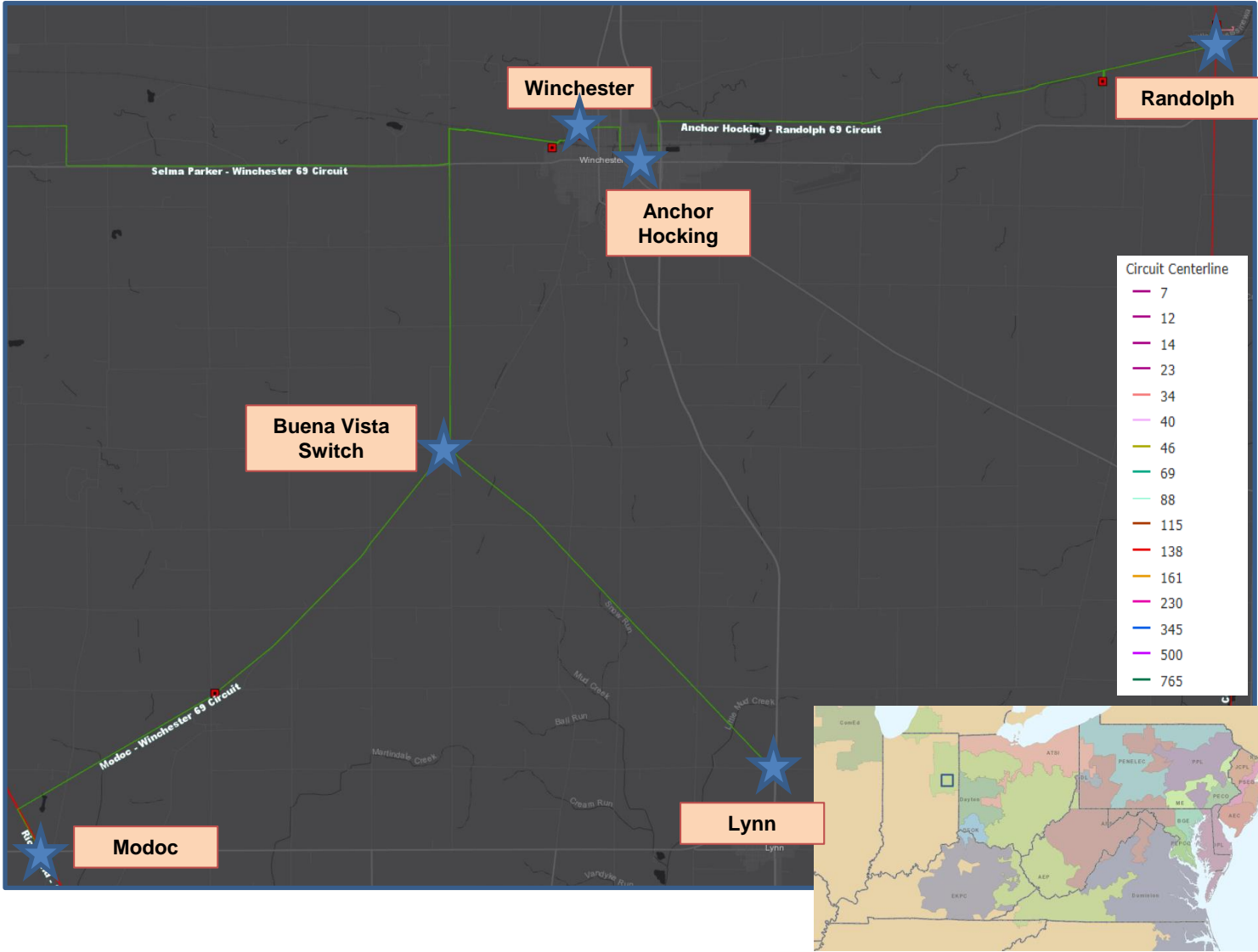

AEP Transmission Zone M-3 Process Winchester Area Improvements Supplemental

Need Number: AEP-2020-IM004

Process Stage: Submission of Supplemental Project for inclusion in the Local Plan
08/06/2020

Selected Solution:

Rebuild the 1.25 mile long Anchor Hocking-Winchester 69 kV circuit. **(S2273.1) Estimated Cost: \$5.9M**

Expand and upgrade Anchor Hocking station to a 5 breaker ring bus to accommodate 5 elements (2 transmission lines and 3 distribution transformers). **(S2273.2) Estimated Cost: \$6.7M**

Replace circuit breakers A & B at Winchester station. **(S2273.3) Estimated Cost: \$3.0M**

At Modoc station, replace 138/69kV Transformer #1. Install a 3 breaker ring bus eliminating the 3 terminal line. **(S2273.4) Estimated Cost: \$11.8M**

At Randolph station, replace 138/69/12 kV Transformer #1 with a 138/69kV 90MVA unit, move the distribution load to a new 138/12kV transformer, and install a 138kV bus tie circuit breaker. Replace cap switcher AA. **(S2273.5) Estimated Cost: \$6.8M**

At Lynn station, install 2 69kV switches for sectionalizing. **(S2273.6) Estimated Cost: \$0.8M**

Replace the Huntsville (REMC) switch structure on the Modoc – Winchester 69kv line. **(S2273.7) Estimated Cost: \$0.6M**

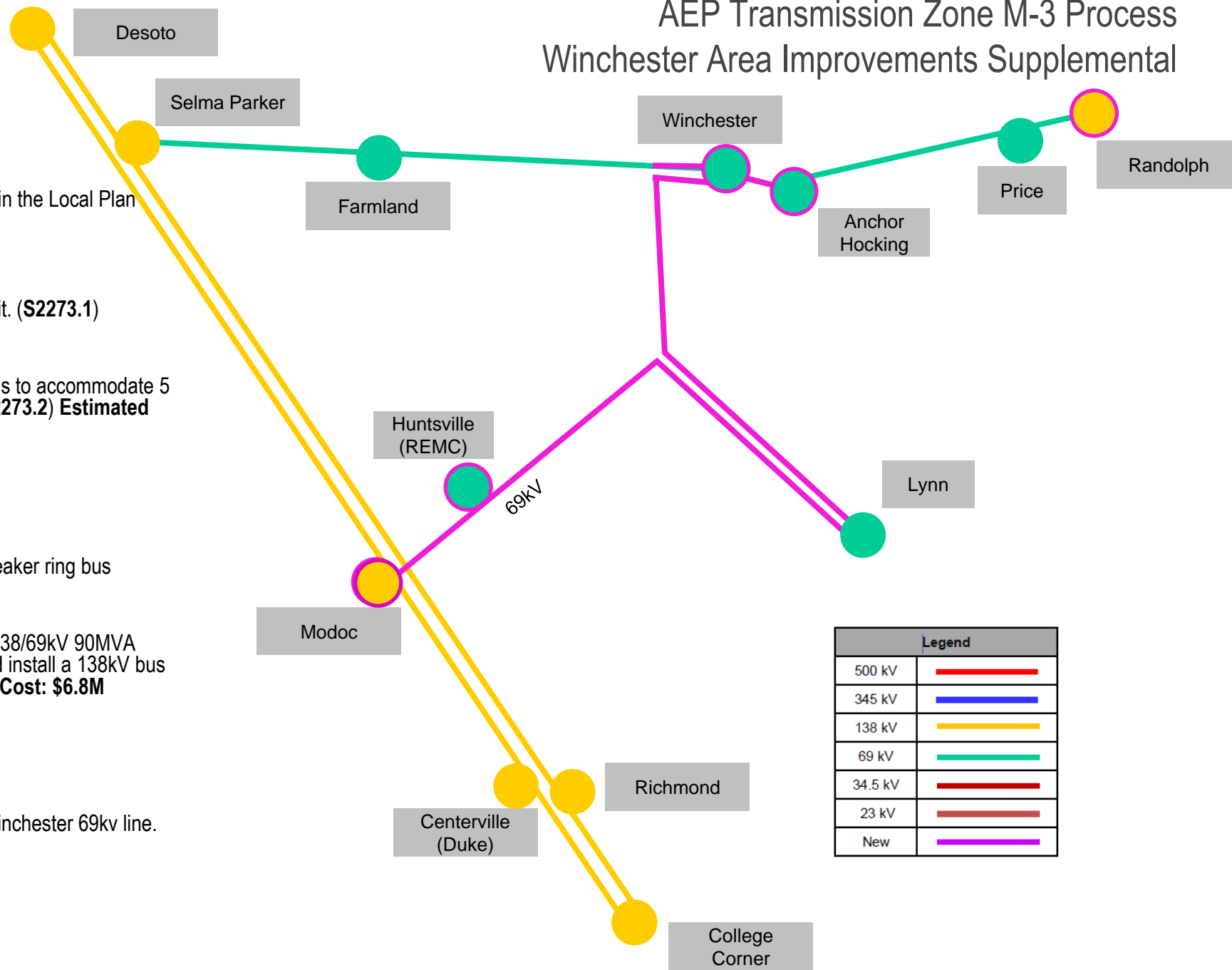

Legend	
500 kV	
345 kV	
138 kV	
69 kV	
34.5 kV	
23 kV	
New	

AEP Transmission Zone M-3 Process Winchester Area Improvements Supplemental

Need Number: AEP-2020-IM004

Process Stage: Submission of Supplemental Project for inclusion in the Local Plan 08/06/2020

Selected Solution Continued:
 Rebuild the 13.4 mile Modoc-Winchester 69 kV line with 11.3 miles as single circuit and 2.1 miles as double circuit. (**\$2273.8**)
Estimated Cost: \$22.8M

Rebuild the 5.7 mile Buena Vista-Lynn 69 kV line as double circuit. (**\$2273.9**) **Estimated Cost: \$9.9M**

Retire Lobdell station. Moved the load from 69kV to 12kV. (**\$2273.10**) **Estimated Cost: \$0.0M**

Retire Buena Vista Switch. (**\$2273.11**) **Estimated Cost: \$0.2M**

Total Estimated Transmission Cost: \$68.5M

Estimated Cost: \$68.5M

Projected In-Service: 08/01/2025

Supplemental Project ID: S2273.1-.11

Project Status: Scoping

Model: N/A

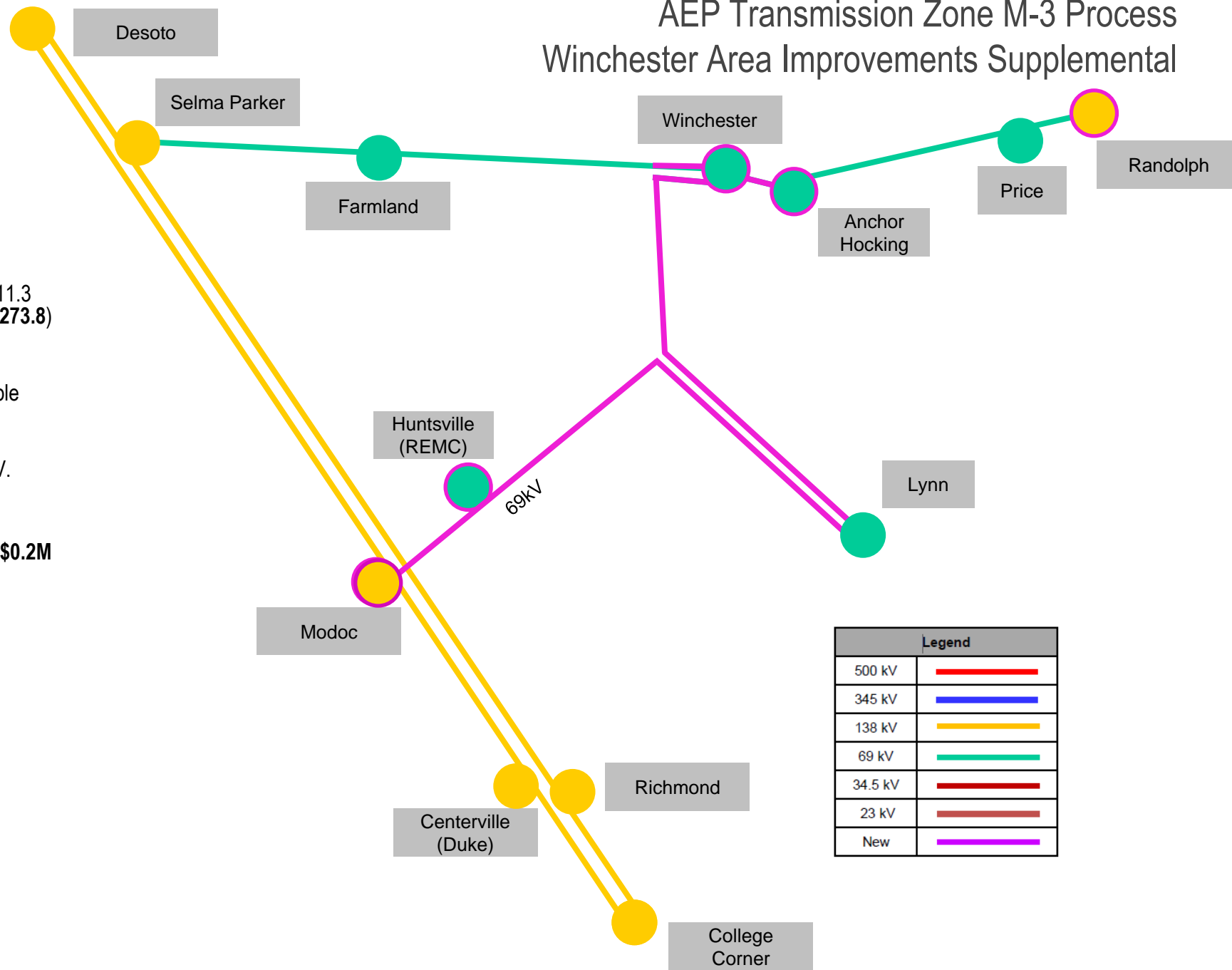

Legend	
500 kV	
345 kV	
138 kV	
69 kV	
34.5 kV	
23 kV	
New	

AEP Transmission Zone M-3 Process Madison-Pendleton 138kV Line Rebuild

Need Number: AEP-2020-IM005

Process Stage: Submission of Supplemental Project for inclusion in the Local Plan 08/06/2020

Previously Presented:

Needs Meeting 02/21/2020

Solutions Meeting 05/22/2020

Project Driver:

Equipment Material/Condition/Performance/Risk/Operational

Specific Assumption Reference:

AEP Guidelines for Transmission Owner Identified Needs (AEP Assumptions Slide 8)

Problem Statement:

Madison – Pendleton 138kV Line (~4.2 Miles)

- 1967 vintage wood pole, H-Frame construction
- There are currently 16 open conditions on this line (9 structures with at least one open condition or 24% of the line).
- Open conditions include: Rotting or bowed crossarms or poles, broken shield wires, and stolen ground lead wires.

Meadowbrook 138/34.5kV station

- Three-terminal line and overlapping zones of protection on the bus, line, and transformer.

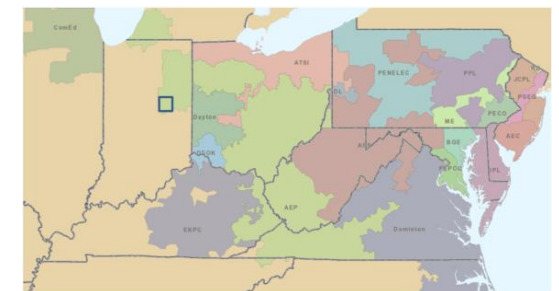
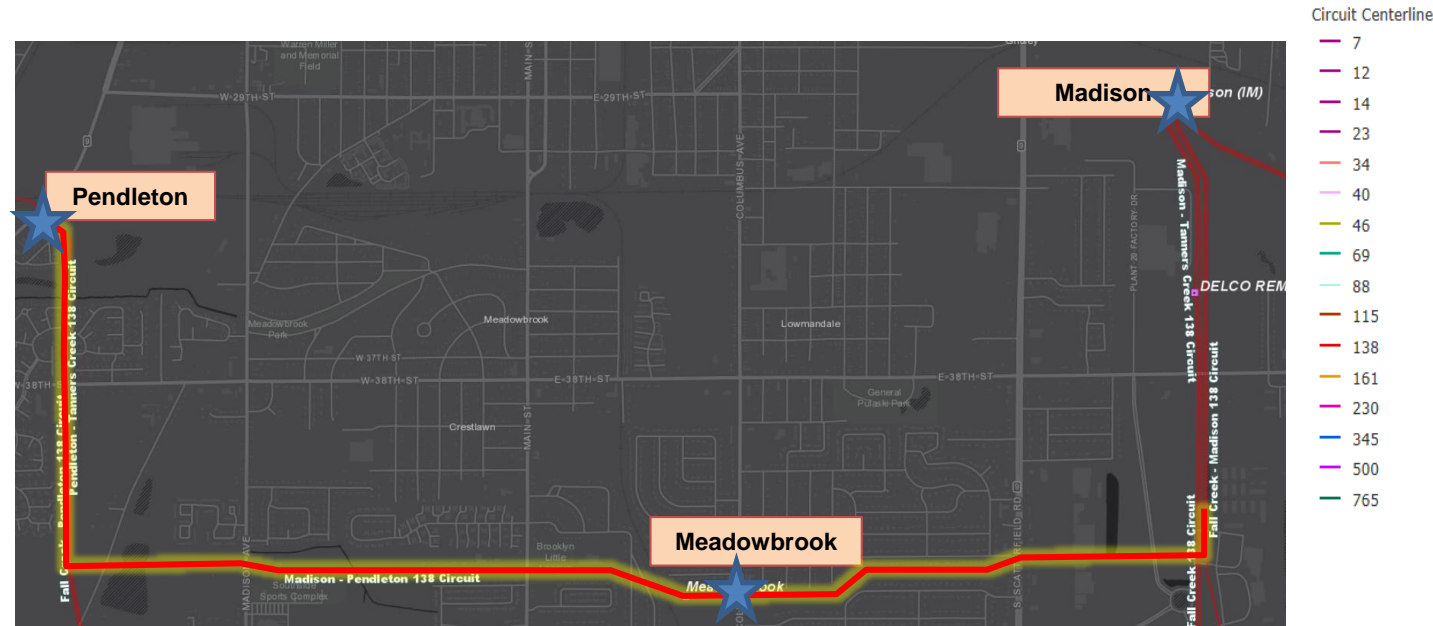

AEP Transmission Zone M-3 Process Madison-Pendleton 138kV Line Rebuild

Need Number: AEP-2020-IM005

Process Stage: Submission of Supplemental Project for inclusion in the Local Plan 08/06/2020

Selected Solution:

Rebuild a 4.17 mile portion of the Madison – Pendleton 138kV single circuit line with DRAKE 795 ACSR 26/7. (~~S2274~~ **S2274.1**) **Estimated Cost: \$7.7M**

At Meadowbrook station, install 2 138kV circuit breakers to eliminate the 3 terminal line. (**S2274.2**)

Estimated Cost: \$2.8M

Estimated Cost: \$10.5M

Projected In-Service: 05/01/2023

Supplemental Project ID: ~~S2274~~ **S2274.1 -.2**

Project Status: Scoping

Model: N/A

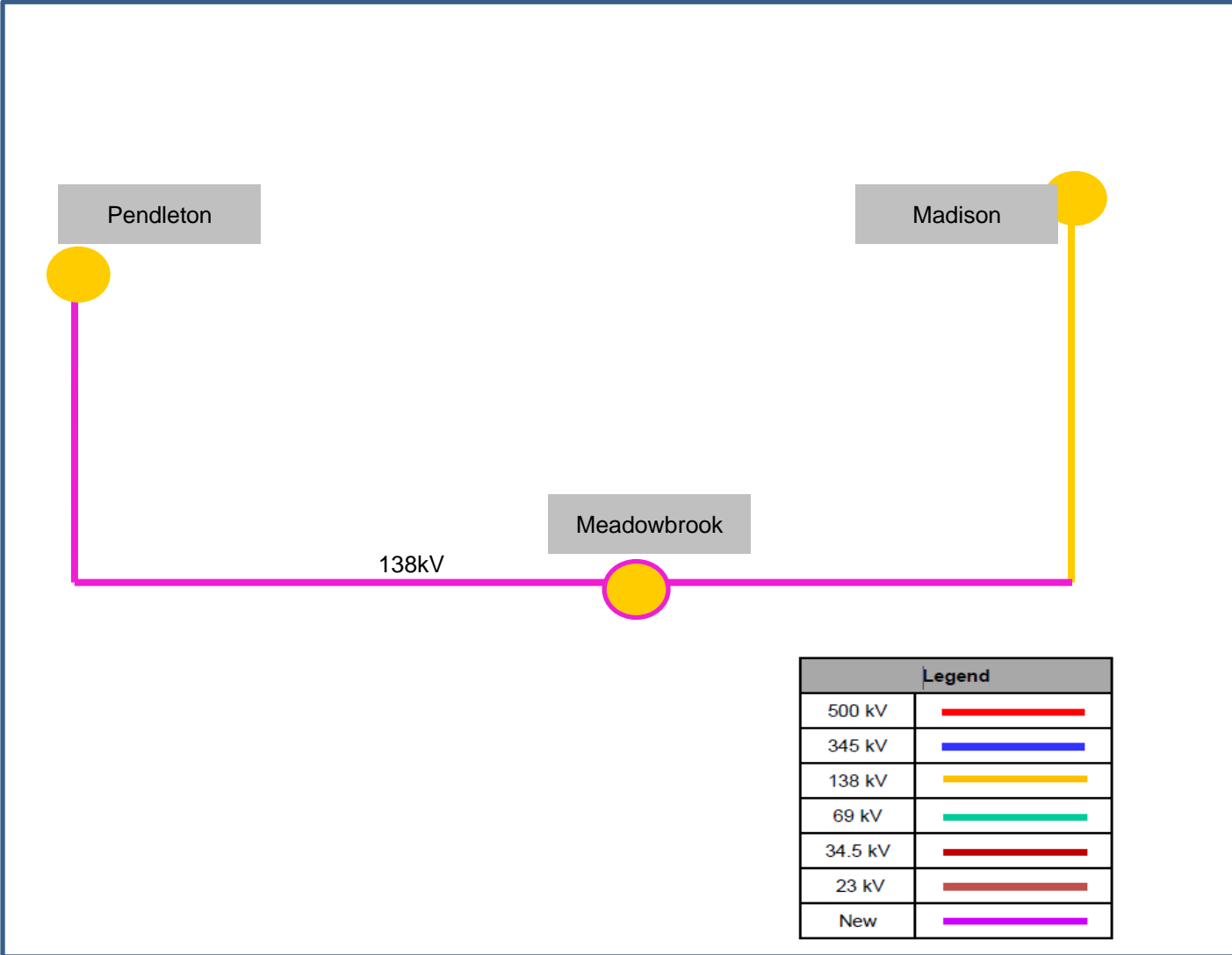

AEP Transmission Zone M-3 Process Rockport Station Improvements

Need Number: AEP-2019-IM042

Process Stage: Submission of Supplemental Project for inclusion in the Local Plan 09/14/2020

Previously Presented:

Needs Meeting 10/25/2019

Solutions Meeting 06/02/2020

Project Driver:

Equipment Condition/Performance/Risk

Specific Assumption Reference:

AEP Guidelines for Transmission Owner Identified Needs (AEP Assumptions Slide 8)

Problem Statement:

Rockport 765kV Station

765kV CB's A, B, B1, B2, C and C2

- These Rockport CB's are ELF-SL8-4 Type SF6 breakers.
- As of September 2019 there are 9 of these breakers remaining in AEP's system including CB A at this station which just recently failed under AEP-2019-IM036.
- Since 2002, there have been 16 documented issues with the 9 remaining breakers dealing primarily with compressor failures and failure to open/reclose.

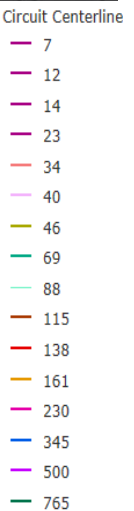
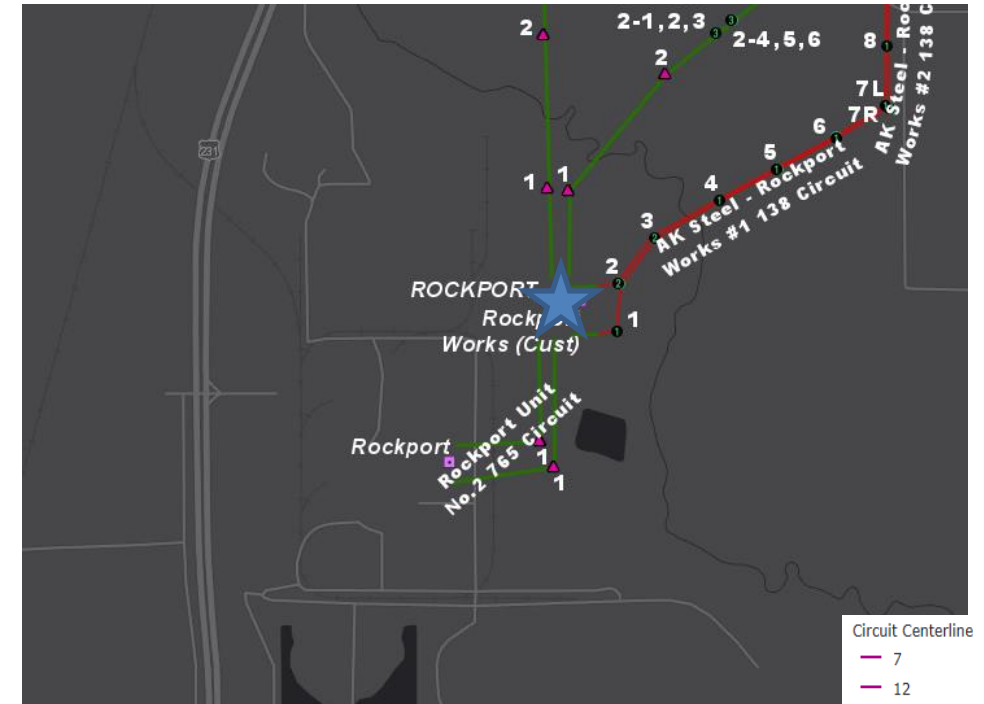

AEP Transmission Zone M-3 Process Rockport Station Improvements

Need Number: AEP-2019-IM042

Process Stage: Submission of Supplemental Project for inclusion in the Local Plan 09/14/2020

Selected Solution:

Rockport 765kV Station:

Replace Rockport CB's B, B2, C and C2 with 765kV SFMT 4000A Cb's (**S2280**)

Estimated Cost: \$18.5M

Projected In-Service: 10/1/2024

Supplemental Project ID: S2280

Project Status: Scoping

Model: N/A

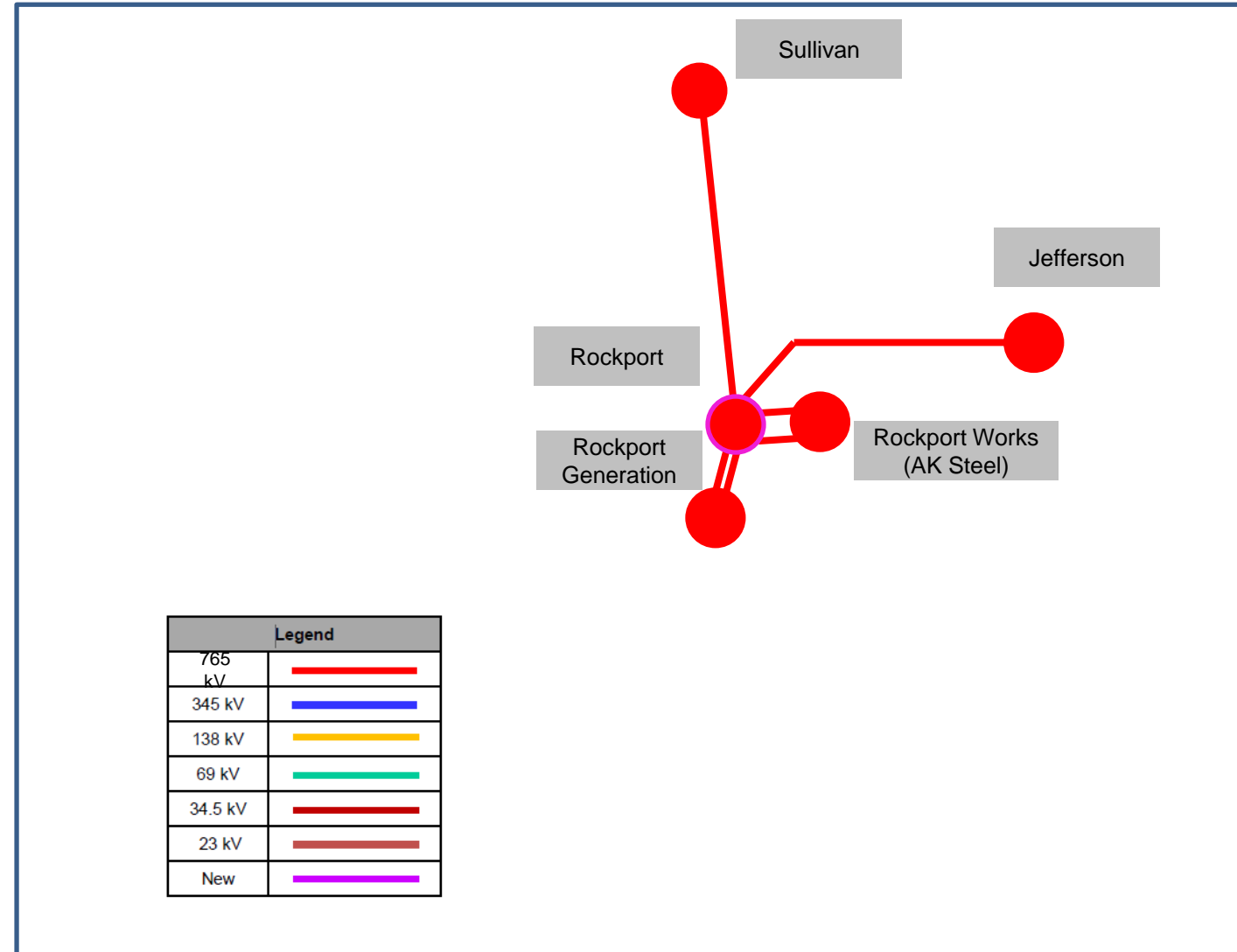

AEP Transmission Zone M-3 Process Inez Station

Need Number: AEP-2018-AP011

Process Stage: Submission of Supplemental Project for inclusion in the Local Plan 9/14/2020

Previously Presented:

Needs Meeting 11/29/2018

Solutions Meeting 06/19/2020

Project Driver:

Equipment Condition/Performance/Risk

Specific Assumption Reference:

AEP Guidelines for Transmission Owner Identified Needs (AEP Assumptions Slide 8)

Problem Statement:

Capacitor switchers 'BB' and 'CC' at Inez station are Mark V model which no longer support modern relaying packages. Mark V's have been historically prone to mechanism failures and are being replaced system wide where possible. S&C circuit switcher 'AA' at Inez station is an S&C 2030 type with no gas monitor.

The Inez 138 kV yard was designed as a breaker and a half station, but the 'B' string was never completed leaving dissimilar zones of protection between the #1 bus and 20+ mile Inez to Johns Creek 138 kV circuit. Dissimilar zones of protection also exist between the 138 kV bus #2, 138/69 kV transformer #1, and the 138 kV circuit to the Martiki coal service point.

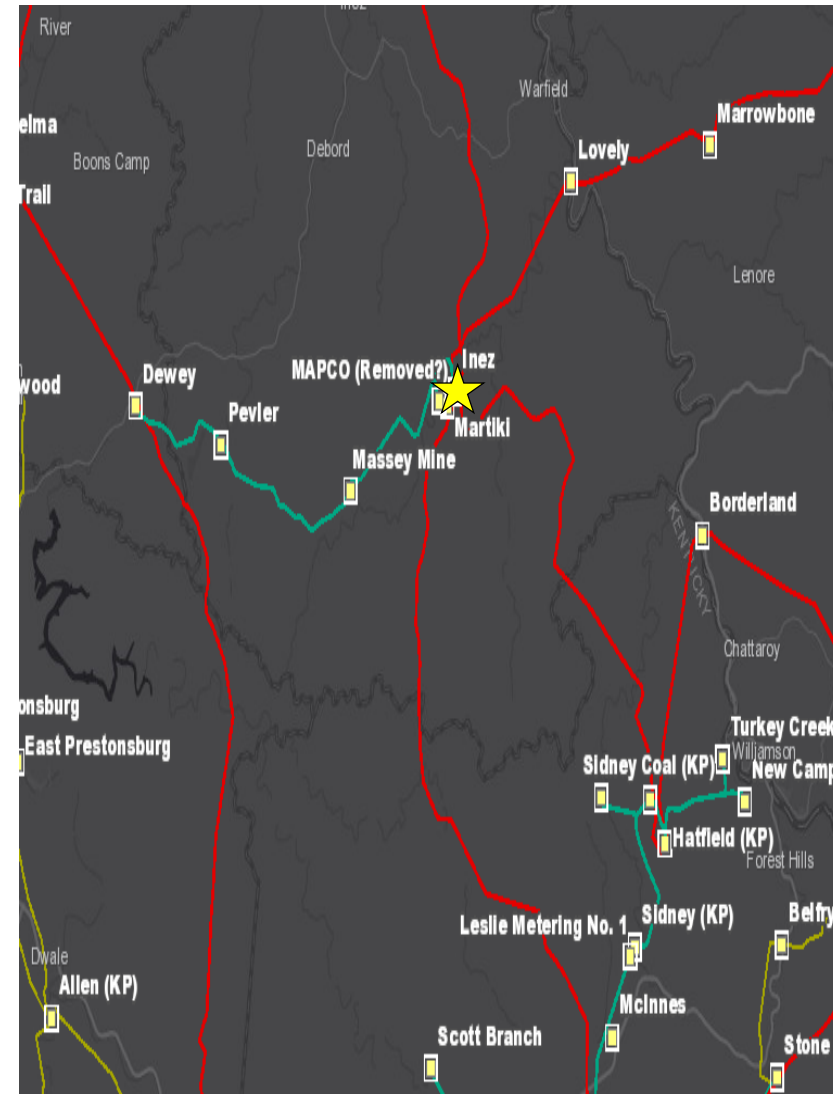

AEP Transmission Zone M-3 Process

Inez Station

Need Number: AEP-2019-AP047

Process Stage: Submission of Supplemental Project for inclusion in the Local Plan 9/14/2020

Previously Presented:

Needs Meeting 12/18/2019

Solutions Meeting 6/19/2020

Project Driver:

Equipment Material/ Condition/Performance/Risk

Specific Assumption Reference:

AEP Guidelines for Transmission Owner Identified Needs (AEP Assumptions Slide 8)

Problem Statement:

- The 138/69kV-13.09kV TR1 is 1967 vintage and has seen significant increases in moisture levels and power factor which indicate a rise in concentrations of harmful particles within the oil. The Short Circuit strength is decreased due to the age of this unit's insulation materials. As the insulating paper ages, it becomes brittle allowing for increased susceptibility to short circuit faults causing failure of the main tank. The transformer has numerous observed oil leaks including fluid leaking from the internal wiring.
- The four 138kV circuit breakers, B, B2, C and C1, are 1990's vintage SF6, HVB145-40000-A type breakers. The circuit breakers have experienced the following fault operations: CB B (38), B2 (22), C (99), and C1(70). CB-B had 52 leaks reported in malfunction records related to low SF6 gas levels. CB-B2 had 24 and CB-C1 had 10 reported SF6 leaks.
- Inez Substation currently deploys 105 relays to ensure the adequate protection and operation of the substation. Currently, 71 of the 105 relays (68% of all station relays) are in need of replacement due to obsolescence. 61 are of electromechanical type, six are static type, and four are discontinued microprocessor relays.

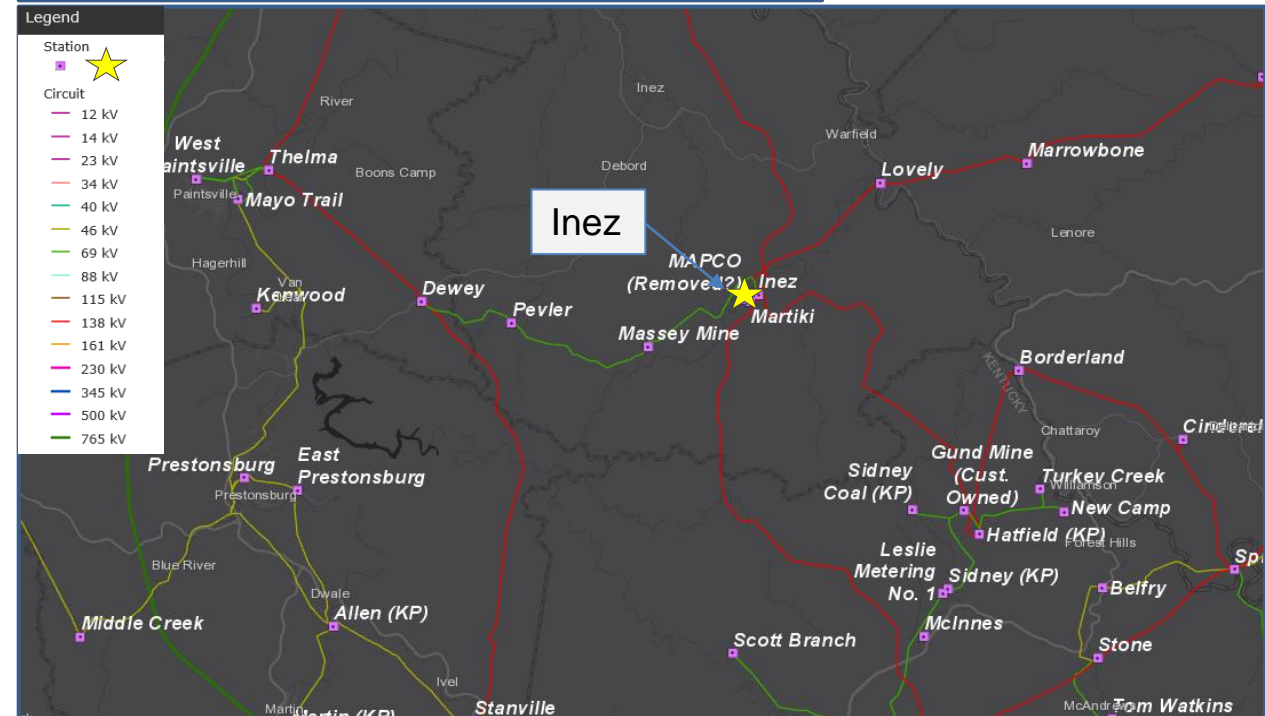
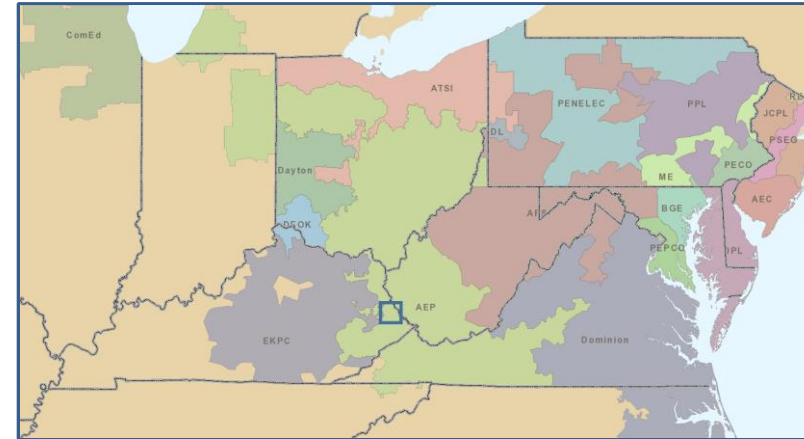

AEP Transmission Zone M-3 Process Inez Station

Need Number: AEP-2018-AP011, AEP-2019-AP047

Process Stage: Submission of Supplemental Project for inclusion in the Local Plan 9/14/2020

Selected Solution:

- At Inez station, replace Breakers B, B2, C and C1. Install three new 138kV breakers and create third string in the existing breaker and half configuration. Replace 138/69kV Inez Transformer #1 with a 138/69kV/12kV 90 MVA autotransformer. Move the new Inez 139/69/12kV Transformer #1 and Martiki 138kV feed to the new string. Install Breaker B1 towards Johns Creek to complete the string. Installation of Breaker B1 and the third string addresses dissimilar zones of protection between the #1 bus and 20+ mile Inez to Johns Creek 138 kV circuit and dissimilar zones of protection between the 138 kV bus #2, 138/69 kV transformer #1, and the 138 kV circuit to the Martiki coal service point. Replace Cap bank switchers CS-BB and CS-CC with 138kV circuit breakers. Replace obsolete relays at Inez substation. Retire 69kV Capacitor Bank and the circuit switcher AA. **(S2281.1) Estimated Cost: \$10.7 M**
- Remote end work at Big Sandy, Logan, Sprigg and Dewey substations. **(S2281.2) Estimated Cost: \$1.7M**

Total Estimated Transmission Cost: \$12.4 M

Projected In-Service: 9/1/2022

Supplemental Project ID: S2281.1-.2

Project Status: Scoping

Model: N/A

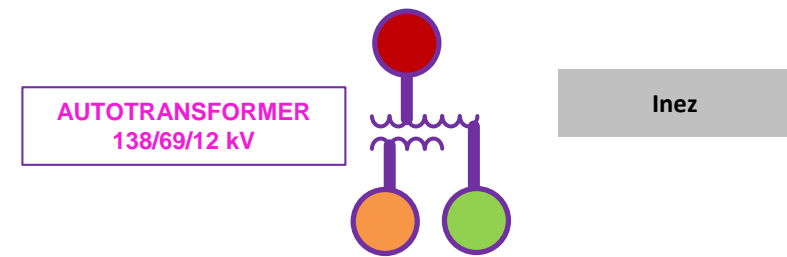

Legend	
345 kV	
138 kV	
69 kV	
12 kV	
New	

AEP Transmission Zone M-3 Process Shannon Station Rebuild

Need Number: AEP-2018-OH018

Process Stage: Submission of Supplemental Project for inclusion in the Local Plan 9/14/2020

Previously Presented:

Needs Meeting 11/29/2018

Solutions Meeting 6/19/2020

Project Driver:

Equipment Material/Condition/Performance/Risk, Operational Flexibility and Efficiency

Specific Assumption Reference:

AEP Guidelines for Transmission Owner Identified Needs

Problem Statement:

- A study of the current physical loading capability of the structures along the Astor-Shannon-Groves & Shannon – Bixby 138 kV circuits revealed that many of the poles are currently overloaded under NESC Heavy Loading Conditions. Additionally, the line structures are unable to handle the addition of telecom fiber, which is needed to improve communications in this area.

Existing NESC Heavy Loading Conditions:

- 36% of poles on the Astor-Bixby 138 kV circuit show overloading.
- 29% of poles on the Bixby – Shannon 138 kV circuit show overloading.
- 20% of the poles on the Shannon – Refugee 138 kV circuit show overloading.
- 58% of poles on the Refugee – (Future) Brice 138 kV circuit show overloading.
- 35% of poles on the (Future) Brice – Astor 138kV circuit show overloading.
- Primarily 1952 wood poles (57% of total line)
- Conductor is all from 1952
- 43 (out of 155) structures on the circuit have at least 1 open condition (28%), with a total count of 63 open conditions.
- 23 reported closed conditions – 1 forestry, 4 conductor, 18 structure
- No outage history (0 CMI/CI)
- The Astor-Groves-Shannon 138 kV circuit is a three-terminal line, which limits sectionalizing and can cause mis-operations and over tripping.
- Astor 138 kV Station has ground switch MOAB's on both 138/13 kV transformers. Ground switch MOABs cause intentional high side faults, which can damage nearby equipment.

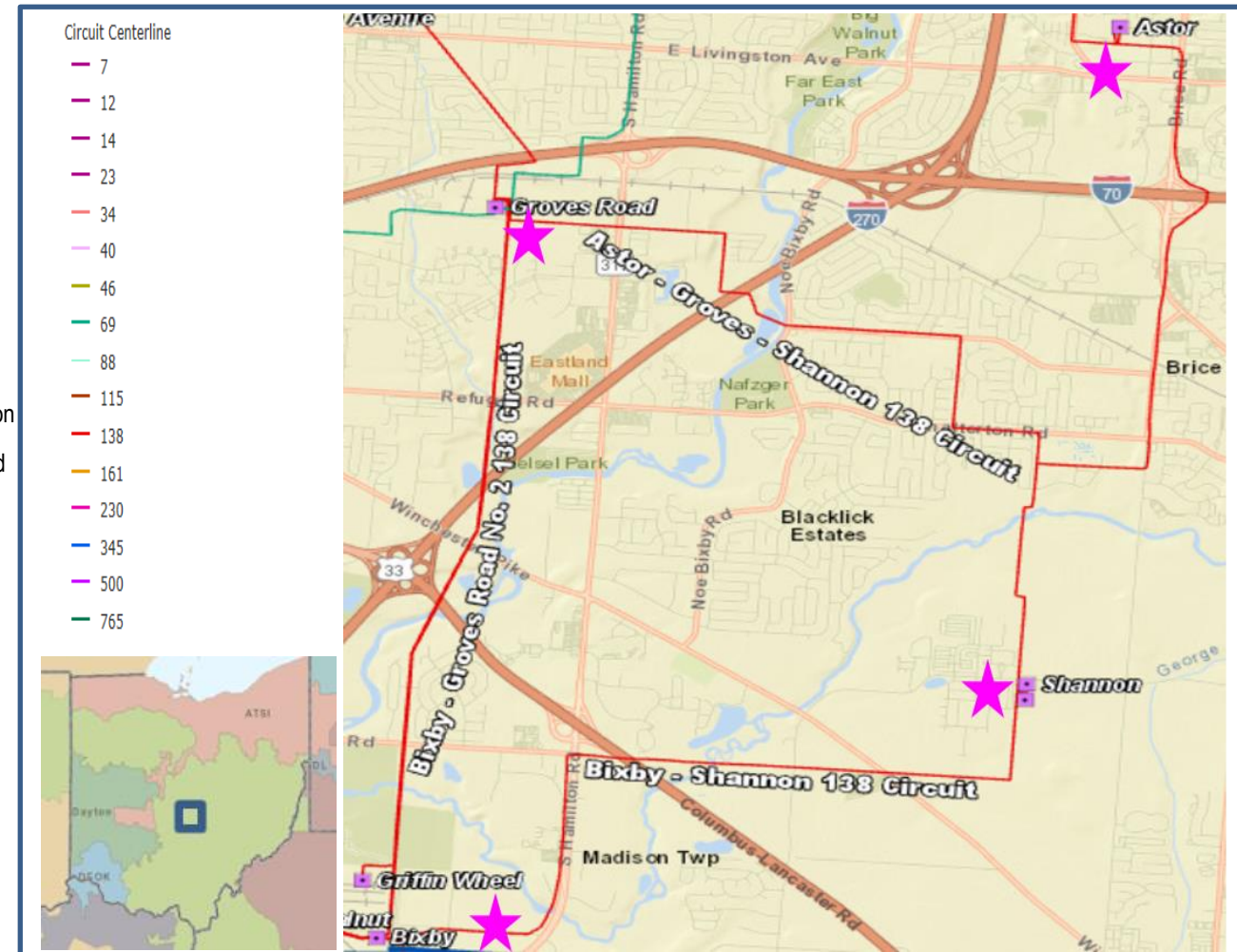

AEP Transmission Zone M-3 Process Shannon Station Rebuild

Need Number: AEP-2018-OH018

Process Stage: Submission of Supplemental Project for inclusion in the Local Plan 9/14/2020

Selected Solution:

- Rebuild ~5.0 miles of 138 kV line between Astor - Shannon. The existing Refugee Switch will be retired. **(S2282.1) Cost: \$21.8M**
- Rebuild ~0.5 miles and construct ~4.6 miles of greenfield 138 kV line between Groves - Shannon to eliminate the three terminal line. **(S2282.2) Cost: \$22.0M**
- Rebuild ~4.3 miles of 138 kV line between Bixby – Shannon. **(S2282.3) Cost: \$15.1M**
- Reconfigure lines at Shannon to accommodate the new 138 kV circuit from Groves. Install two new 138 kV 3000A 40 kA circuit breakers on circuits towards Brice and Bixby to prevent dissimilar zones of protection when bringing the 3rd 138 kV circuit to the station. **(S2282.4) Cost: \$1.9M**

Ancillary Benefits: Provides a third transmission source into AEP Ohio’s Shannon station (35 MVA/ 90 MVA capacity) that has limited ability to transfer load.

Total Estimated Transmission Cost: \$60.8 M

Projected In-Service: 11/1/2024

Supplemental Project ID: S2282.1 -.4

Project Status: Scoping

Model: N/A

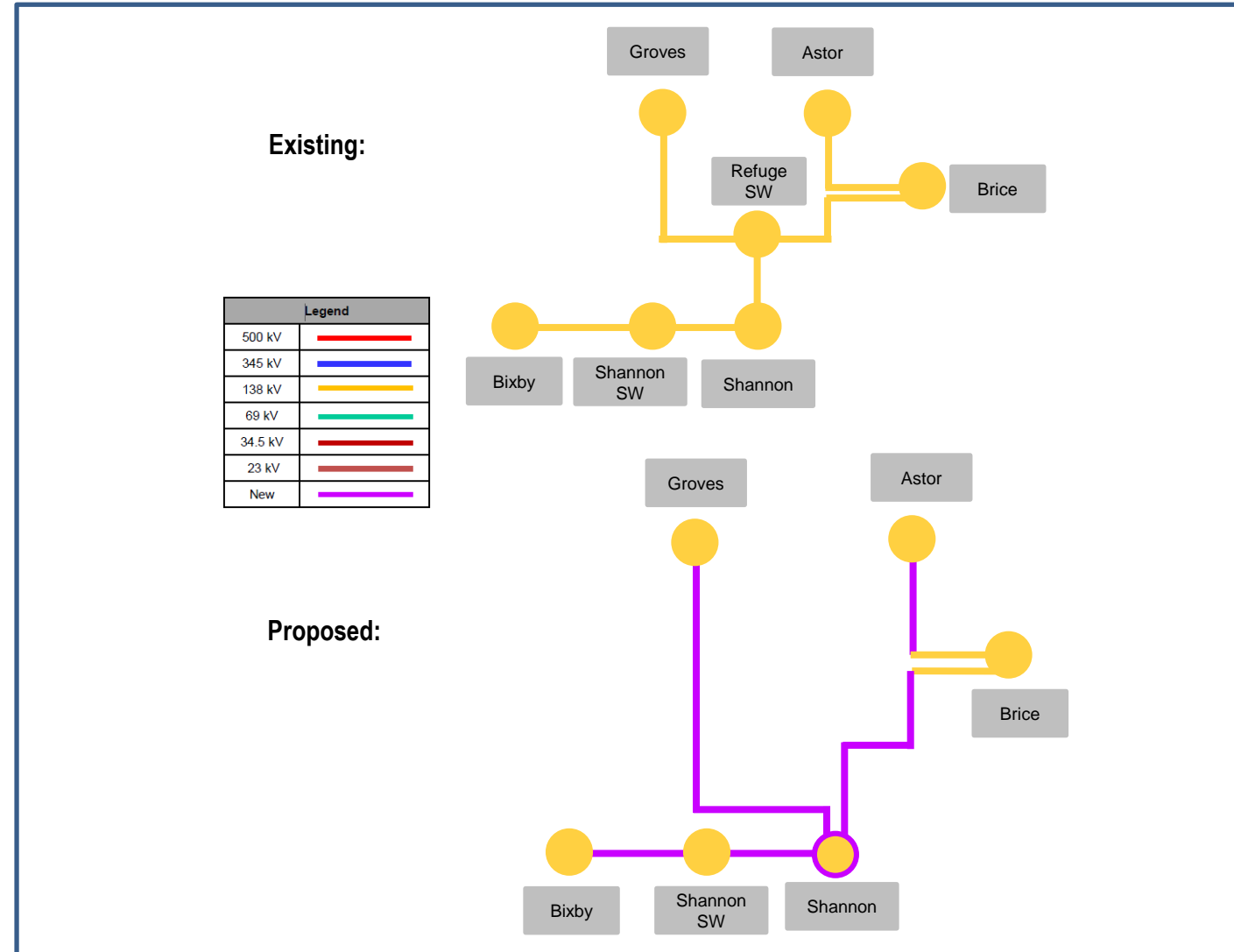

AEP Transmission Zone M-3 Process

Lott 138kV Deliver Point Solution

Need Number: AEP-2019-OH039

Process Stage: Submission of Supplemental Project for inclusion in the Local Plan 9/14/2020

Previously Presented:

Needs Meeting 6/17/2019

Solutions Meeting 6/19/2020

Project Driver:

Equipment Condition, Operational Flexibility, and Customer Service

Specific Assumption Reference:

AEP Guidelines for Transmission Owner Identified Needs (AEP Assumptions slide 8); AEP Connection Requirements for the AEP Transmission System (AEP Assumptions Slide 7)

Problem Statement:

Lott Delivery Point (CEC):

- Buckeye Power, on behalf of Consolidated Electric Cooperative, has requested transmission service in Delaware County west of Centerburg, Ohio.
- Consolidated Electric Cooperative customers are currently connected to a radial 34.5 kV distribution line from AEP Ohio's Trent station.
- The delivery point has consistently been identified as having poor reliability by Buckeye.
- Consolidated Electric Cooperative has reported approximately 700 thousand customer-outage minutes (CMI) over a three year period (2015-2017).

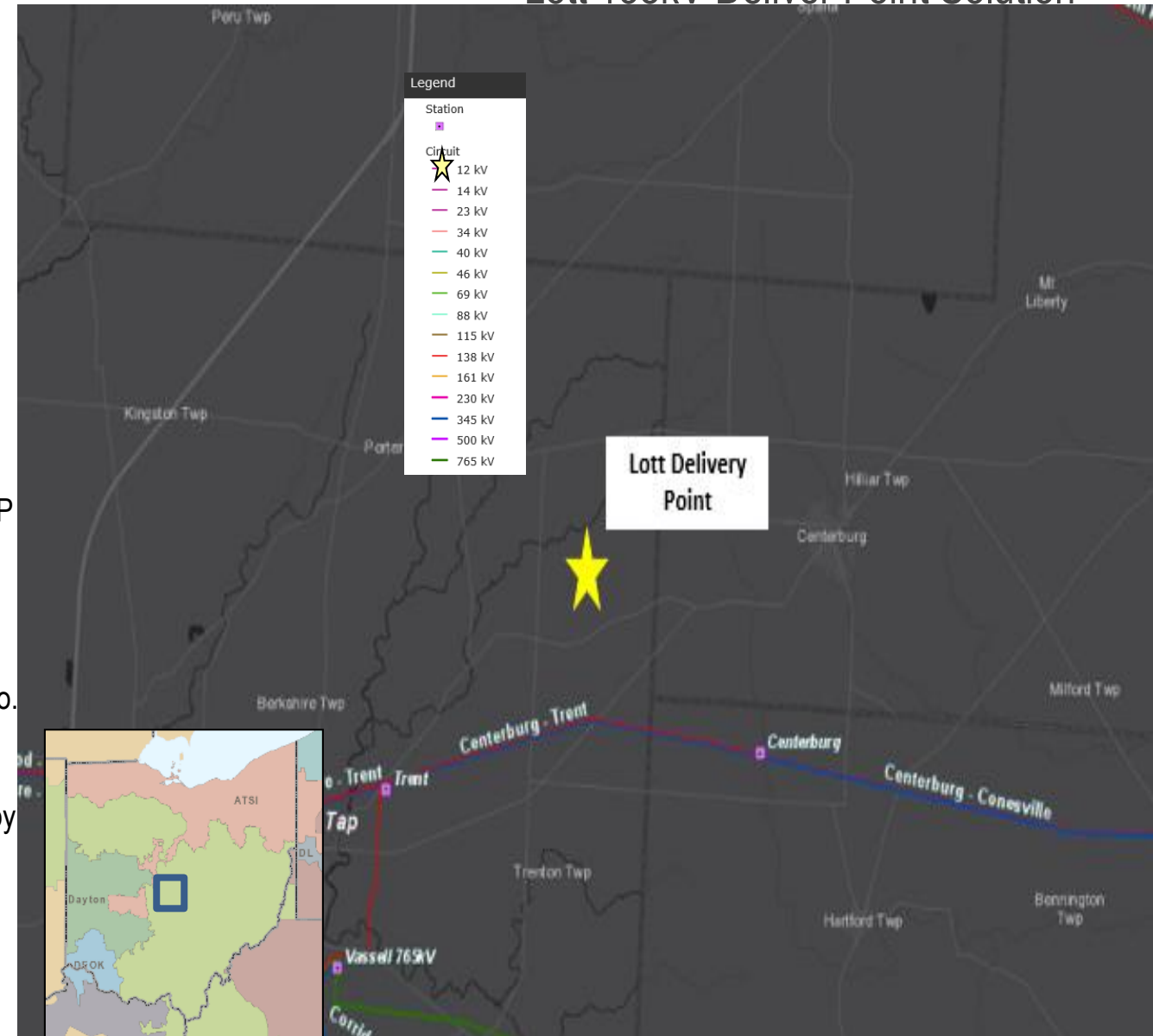

AEP Transmission Zone M-3 Process Lott 138kV Deliver Point Solution

Need Number: AEP-2019-OH039

Process Stage: Submission of Supplemental Project for inclusion in the Local Plan 9/14/2020

Selected Solution:

- Build ~ 3.75 miles of single circuit 138kV transmission line from new Condit 3-way MOAB Switch (tapping the Centerburg – Trent 138kV circuit) to Lott station (Consolidated Co-op). **(S2283.1) Estimated Cost: \$9.86M**
- Build Condit 3-way MOAB 138kV switch **(S2283.2) Estimated Cost: \$0.78M**

Estimated Cost: \$10.64 M

Projected In-Service: 6/1/2024

Supplemental Project ID: S2283.1-.2

Project Status: Scoping

Model: 2024 RTEP

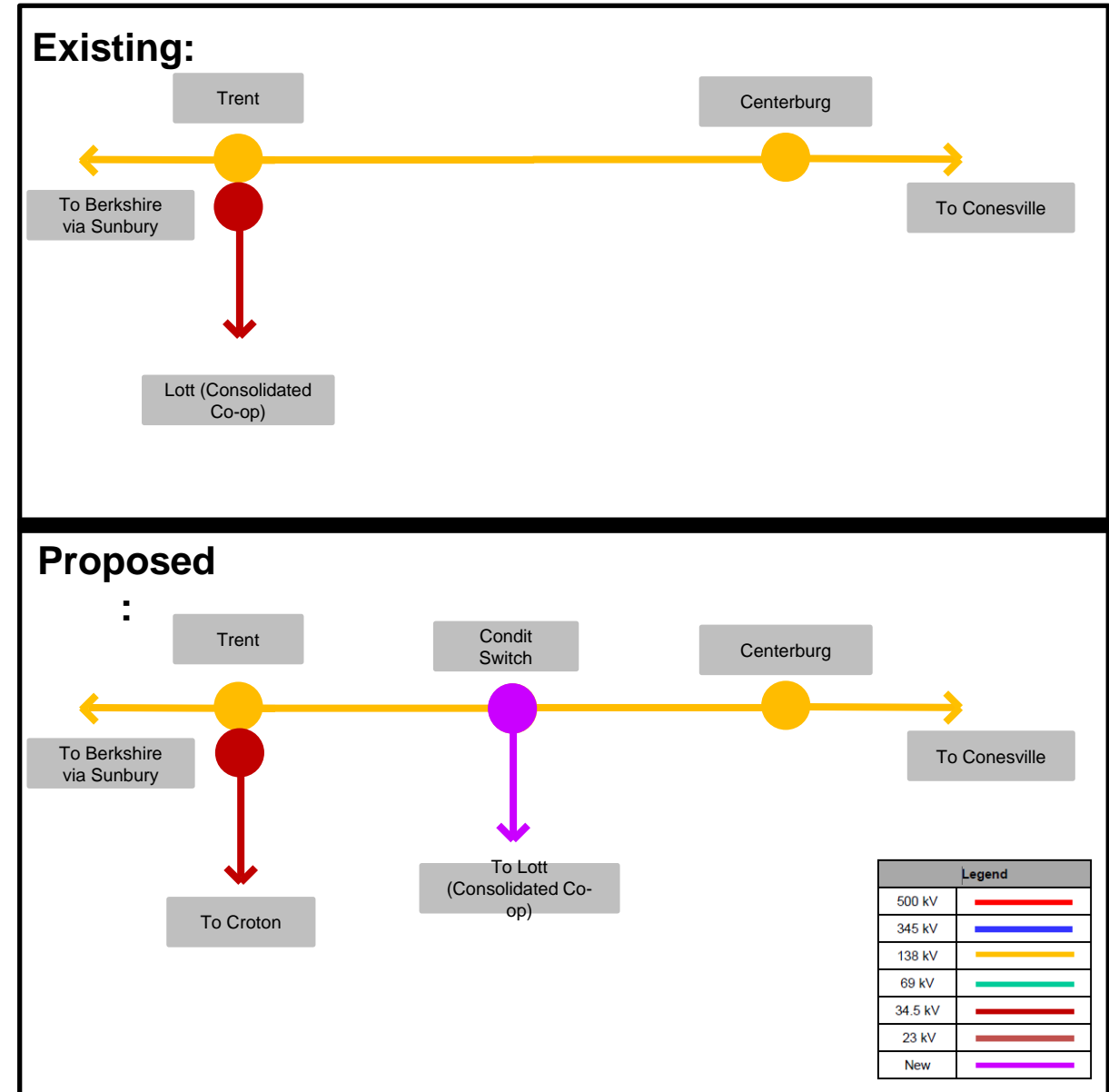

AEP Transmission Zone M-3 Process Canal Street – Marion Road UG Solution

Need Number: AEP-2020-OH013

Process Stage: Submission of Supplemental Project for inclusion in the Local Plan 9/14/2020

Previously Presented:
Needs Meeting 2/21/2020
Solutions Meeting 6/19/2020

Project Driver:
Equipment Condition/Performance/Risk

Specific Assumption Reference:

AEP Guidelines for Transmission Owner Identified Needs (AEP Assumptions Slide 8), Customer Service

Problem Statement:

Canal Street – Marion Road 138 kV Underground Circuit

- Ohio Department of Transportation (ODOT) has requested that approximately 1500 feet of the existing Canal – Marion 138 kV underground circuit be relocated as part of a planned Interstate improvement project.
- The existing Canal – Marion 138 kV underground circuit is approximately 3.8 miles long and was originally installed in the 1950's.
- The circuit utilizes an underground oil-filled pipe type cable design. Oil-filled pipe type underground cables come with several challenges/risks in densely populated urban areas. Lead times for replacement/repairs from the remaining single vendor can be 6 months to a year. Even minor issues with the cable could result in costly outages over an extended period of time due to this single remaining vendor.

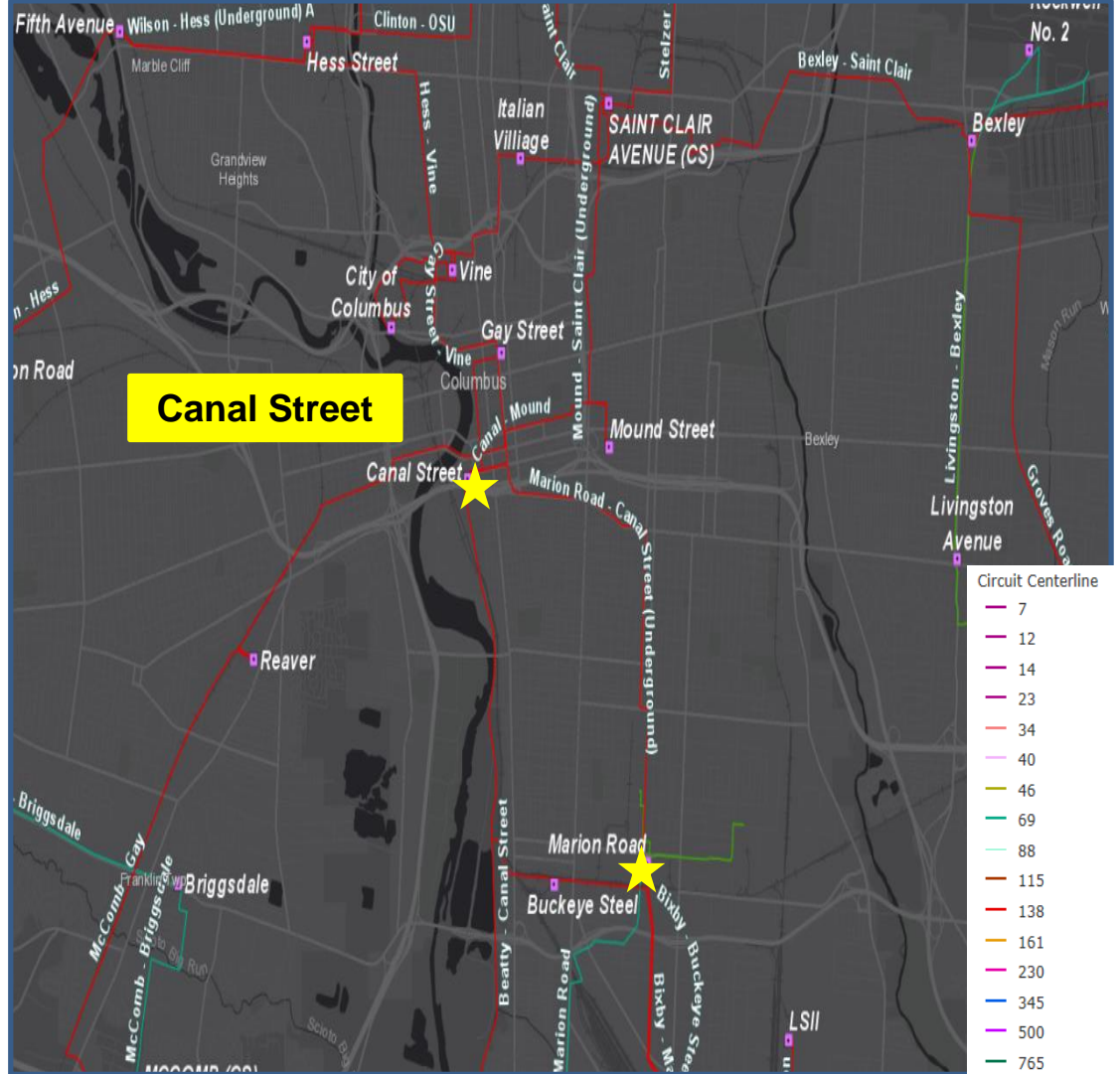

AEP Transmission Zone M-3 Process Canal Street – Marion Road UG Solution

Need Number: AEP-2020-OH013 & AEP-2020-OH025

Process Stage: Submission of Supplemental Project for inclusion in the Local Plan 9/14/2020

Selected Solution:

- Retire ~ 3.8 miles of underground oil filled pipe type 138kV circuit between Canal St. – Marion Rd. **(S2284.1) Estimated Cost: \$1.6M**
- Build ~ 3.1 miles of underground single circuit 138kV line between Marion Rd. and Mound St. utilizing XLPE cable. **(S2284.2) Estimated Cost: \$35.8M**
- At Canal Street, install two new 138kV CBs (3000A, 63kA) to electrically terminate the Buckeye Steel – Gay St. 138 kV circuit that already physically runs through the station. Replace breaker '4' with new 138kV CB (3000A, 63kA). **(S2284.3) Estimated Cost: \$ 3.1M**
- At Mound Street, install new 138kV CB (3000A, 63kA) to accommodate new circuit from Marion Rd. **(S2284.4) Estimated Cost: \$1.2M**
- At Vine Street, install a 2% series line reactor towards Gay Street station to limit fault contribution increases from reconfigurations of lines in the area. **(S2284.5) Estimated Cost: \$1.1M**
- Remote end relay work at Gay Street. **(S2284.6) Estimated Cost: \$0.2M**
- Remote end relay work at Bixby station. **(S2284.7) Estimated Cost: \$0.6M**
- Relaying upgrades and line termination structure replacement at Marion Road. **(S2284.8) Estimated Cost: \$1.4M**

Ancillary Benefits: The proposed solution will provide a third source into the existing Mound Street station. Mound Street serves a number of critical loads, including the nearby Nationwide Children's Hospital. Ability to transfer load from the station is extremely limited. The station is also 1 of only 2 stations on AEP's footprint solely sourced by underground oil filled pipe type cable. This carries with it inherent reliability concerns associated with the potential risk of extended outages and reliance on one remaining vendor that supports this cable type. Currently, emergency generation has to be brought on site anytime that one of the cables is out to support critical loads from the station. A third source will alleviate the need to bring the generation in for an outage of one of the lines.

Estimated Cost: \$45 M

Projected In-Service: 5/1/2022

Supplemental Project ID: S2284.1-.8

Project Status: Scoping

Model: N/A

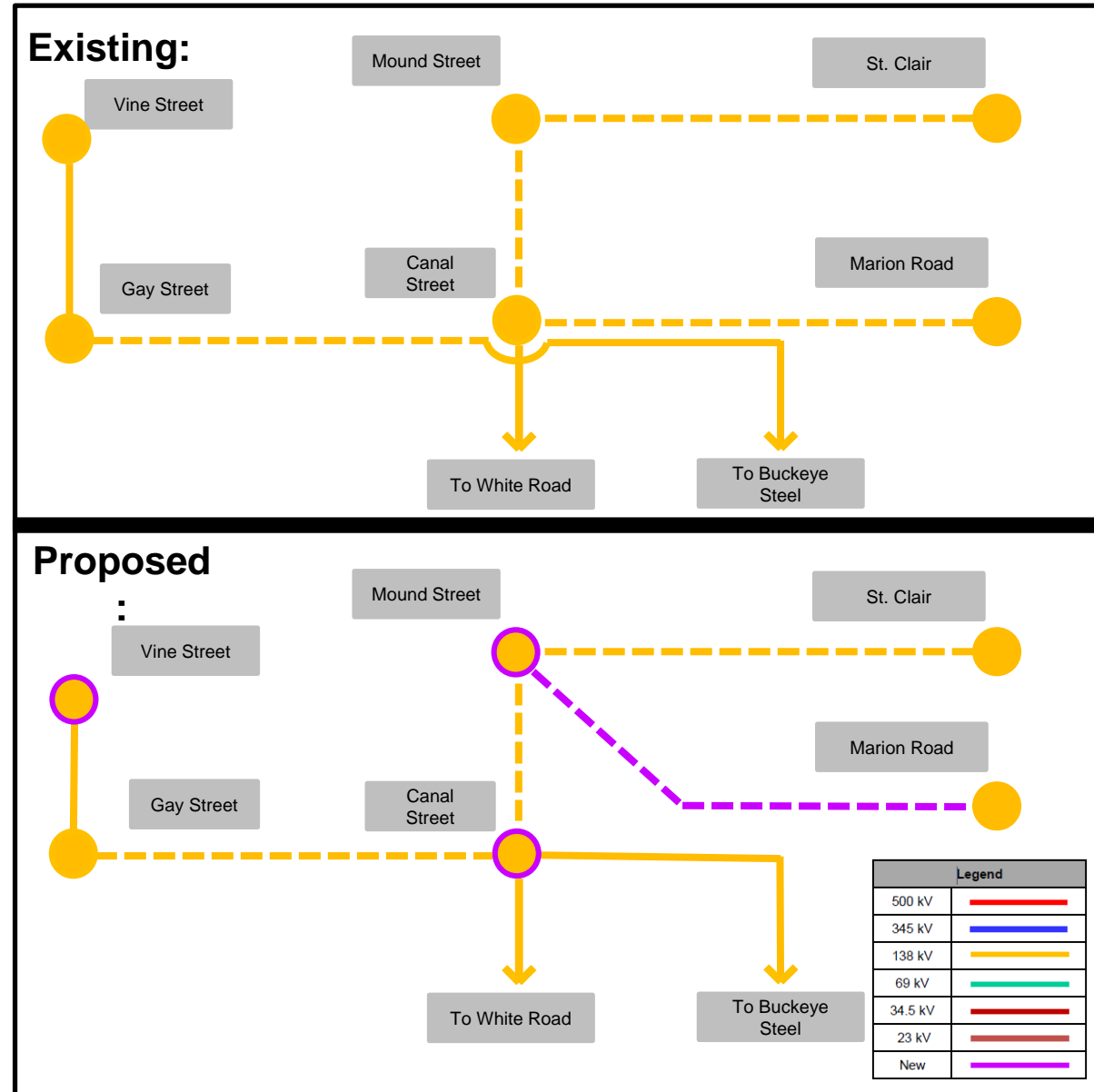

AEP Transmission Zone M-3 Process Chemical Area Project

Need Number: AEP-2018-AP018

Process Stage: Submission of Supplemental Project for inclusion in the Local Plan 10/14/2020

Previously Presented:

Needs Meeting 1/11/2019

Solutions Meeting 7/17/2020

Project Driver:

Equipment Material/Condition/Performance/Risk

Specific Assumption Reference:

AEP Guidelines for Transmission Owner Identified Needs (AEP Assumptions Slide 8)

Problem Statement:

Chemical 138/46 kV XF #1 has been declared a failure. Operations has noted that Chemical 138/46 kV XF #1 fans and cooling system are not working properly and winding temperature was documented at an extremely hot level of 109°C prior to taking the unit offline in 2017. There are no parts attainable to repair the obsolete cooling system. In addition, interfacial tension has been diminished since 2002. This is an early indication of the development of sludge which can impede oil circulation, further hampering the ability of the unit to cool. Based on dissolved gas analysis, the observed gas concentrations, specifically of ethylene and acetylene, are likely the result of a mixture of thermal and electrical faults along with the carbonization of the insulating paper. The signal of insulation paper carbonization, which generates particles in the oil, highly correlates to the generation of sludge indicated by the interfacial tension.

Chemical 138/46 kV XF #2 moisture levels have recently been increasing, resulting in downward trending dielectric strength. In addition, interfacial tension has been on the decline. This is an early indication of the development of sludge which can impede oil circulation and cooling. Operations has noted numerous conditions with this unit, most critical of which is that the bank was derated to 33.75MVA because only one pump of three is operational for the cooling system. There are no parts attainable to repair the obsolete cooling system.

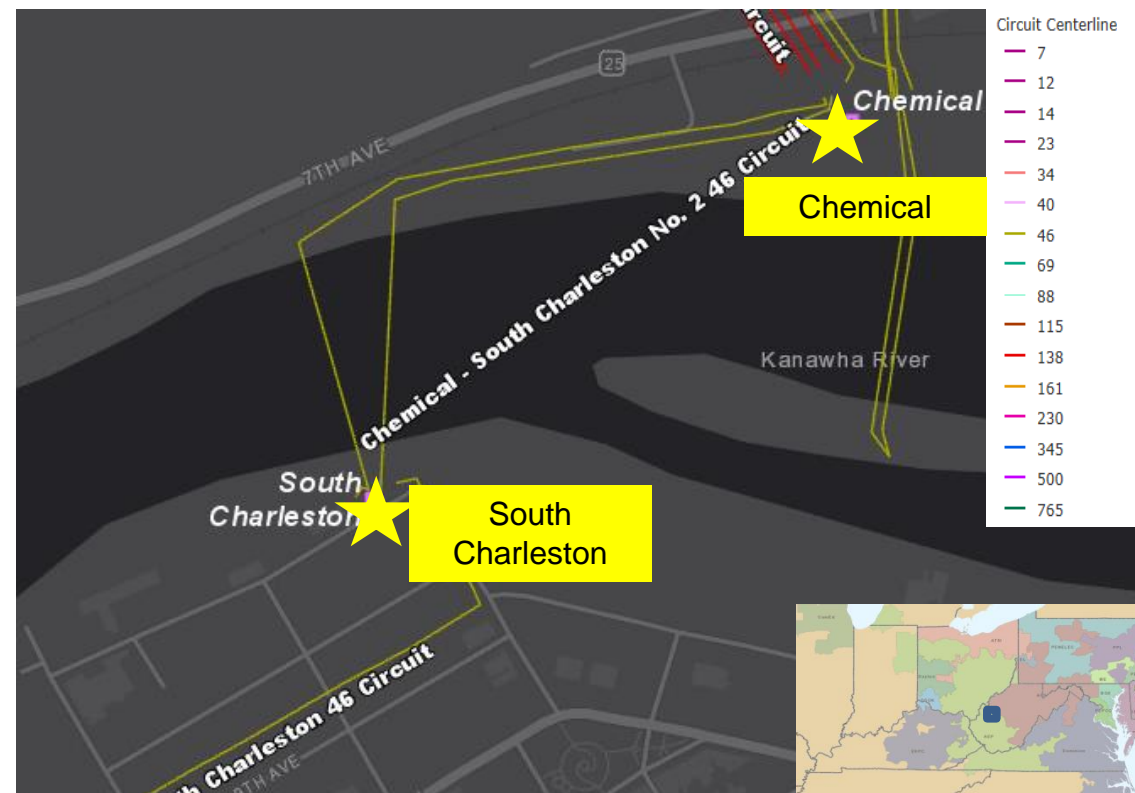

AEP Transmission Zone M-3 Process Chemical Area Project

Need Number: AEP-2018-AP018

Process Stage: Submission of Supplemental Project for inclusion in the Local Plan 10/14/2020

Previously Presented:

Needs Meeting 1/11/2019

Solutions Meeting 7/17/2020

Project Driver:

Equipment Material/Condition/Performance/Risk

Specific Assumption Reference:

AEP Guidelines for Transmission Owner Identified Needs (AEP Assumptions Slide 8)

Problem Statement:

The 46kV CBs C, G, H, Q, R, and S are oil filled breakers without secondary oil containment. Oil filled breakers have much more maintenance required due to oil handling that their modern, SF6 equivalents do not require. CBs G and H are 2 of 40 in the FK-72.5-27000-10 model family remaining on the AEP system. CB A is the last FK-339-46-1500-Y model on the entire AEP system. CBs B, Q, R, and S are the last 4 in the FK-339-46-1500-5 model family remaining on the entire AEP system. CB C is the last FK-46-1500 model on the entire AEP system. This scarcity of sister units makes finding spare parts for these units difficult to impossible, and these models are no longer vendor supported.

The 46kV CS CC is an S&C 2030-69 model. The S&C 2030 circuit switcher model family has no gas monitor and sister units on the AEP System have experienced malfunctions; the major ones include gas loss, interrupter failures, and operating mechanism failures.

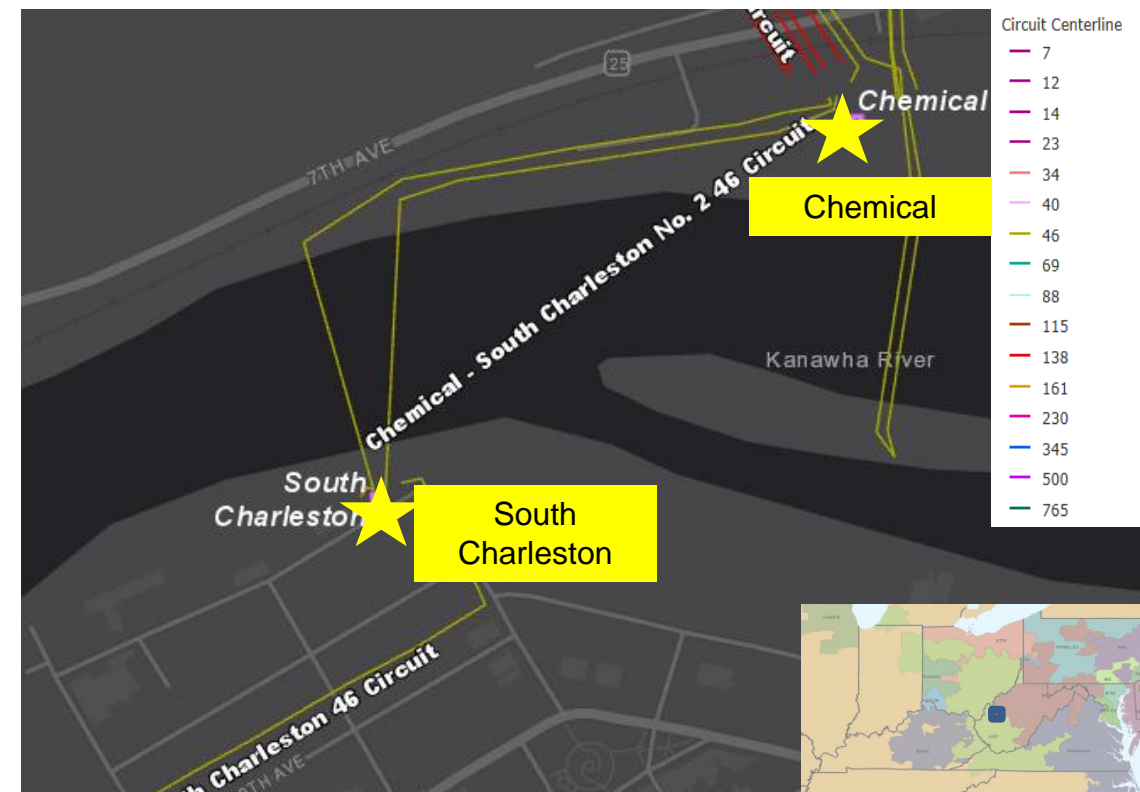

Need Number: AEP-2019-AP010

Process Stage: Submission of Supplemental Project for inclusion in the Local Plan 10/14/2020

Previously Presented:

Needs Meeting 4/23/2019

Solutions Meeting 7/17/2020

Project Driver:

Equipment Material/Condition/Performance/Risk

Specific Assumption Reference:

AEP Guidelines for Transmission Owner Identified Needs (AEP Assumptions Slide 8)

Problem Statement:

- South Charleston 46kV CBs A and B are 460G-3000 oil filled breakers.
 - Oil breakers are more difficult to maintain as oil spills have the potential to occur during maintenance which can be an environmental and safety hazard.
 - These are the last 2 circuit breakers in the 460G-3000 CB model family on the AEP system, making spare parts difficult or impossible to obtain.
- Chemical – South Charleston 46 kV #1 (~0.5mi) currently has 9 open conditions on 8/8 structures.
 - The majority of the circuit is constructed with 1950s wood structures and lattice structures.
 - The conditions include rot shell, insect damage and heavy rust.
- Chemical – South Charleston 46 kV #2 (~0.5mi) currently has 16 open conditions on 9/9 structures.
 - The majority of the circuit is constructed with 1950s lattice and wood structures.
 - The conditions include rot and heavy rust and rot shell.

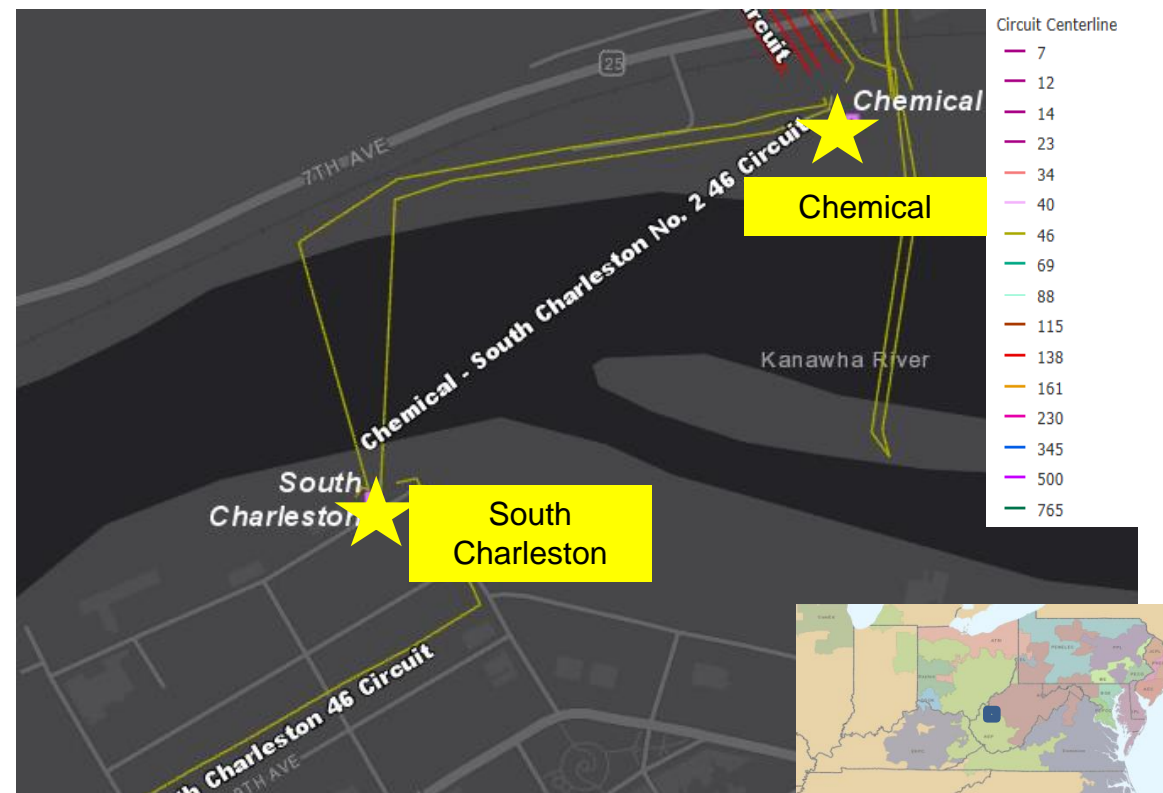

AEP Transmission Zone M-3 Process Chemical Area Project

Need Number: AEP-2018-AP018, AEP-2019-AP010

Process Stage: Submission of Supplemental Project for inclusion in the Local Plan 10/14/2020

Selected Solution:

At Chemical station, replace existing 138/46 kV 45 MVA transformers #1 and #2 with two new 138/46 kV 90 MVA transformers and install two 138 kV high side circuit switchers on each transformer. Retire 138/46 kV transformer #4. Retire 46 kV 18 MVAR capacitor and switcher "DD". Retire 46 kV bus #1, bus #2 and bus #3. Rebuild the 46 kV into a fourteen breaker ring configuration. Replace grounding banks #7 and #8. **(S2348.1) Estimated Cost: \$16.8M**

Line work is required to accommodate the new station configuration on the Chemical – Turner 138 kV line and Chemical – Chesterfield 46 kV line. **(S2348.2) Estimated Cost: \$0.5M**

Remote end work required at Turner Station, Central Avenue Station and Ward Hollow Stations. **(S2348.3) Estimated Cost: \$1.6M**

Rebuild the Chemical – South Charleston #1 and Chemical – South Charleston #2 46 kV lines with a new double circuit 46 kV line (69 kV standards) from Chemical – Criel Mound. **(S2348.4) Estimated Cost: \$5.4M**

At South Charleston, retire the existing circuit breakers A and B and install four new 46 kV 40 kA circuit breakers in a ring at a new station (Criel Mound) adjacent to the existing South Charleston Station. **(S2348.5) Estimated Cost: \$11.0M**

Ancillary Benefits: The creation of a 46 kV ring bus improves the Charleston Area reliability by having at least one 138-46 kV transformer in service at all times to the entire 46 kV system supplied from Chemical Station. In the present configuration, with the No. 1 and No. 2 46 kV Buses electrically separated from the No. 3 46 kV Bus, 46 kV circuit overloads and 46 kV low voltages are a constant contingency issue. Tying all of the 46 kV buses together at Chemical Station creates much more reliability to the Charleston Urban stations, including the State Capitol Complex.

Total Estimated Transmission Cost: \$35.3 M

Projected In-Service: 10/17/2022

Supplemental Project ID: S2348.1 - .5

Project Status: Scoping

Model: 2023 RTEP

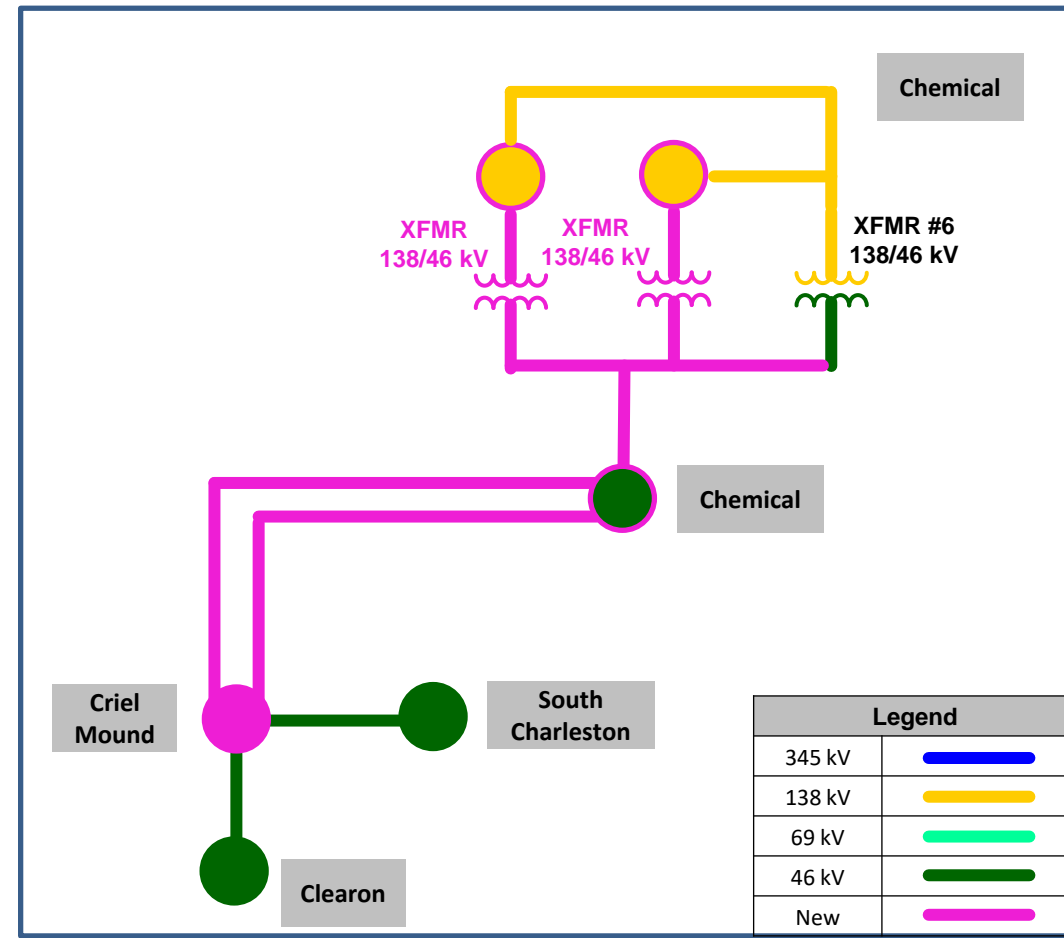

AEP Transmission Zone M-3 Process

Mullens Station

Need Number: AEP-2019-AP002

Process Stage: Submission of Supplemental Project for inclusion in the Local Plan 10/14/2020

Previously Presented:

Needs Meeting 2/20/2019

Solutions Meeting 7/17/2020

Project Driver:

Equipment Condition/Performance/Risk

Specific Assumption Reference:

AEP Guidelines for Transmission Owner Identified Needs (AEP Assumptions Slide 8)

Problem Statement:

- Transformer Bank #4 138/46 kV
 - Short circuit strength breakdown caused by the amount of high energy electrical through fault events
 - Numerous gases are at the IEEE level 2 condition level with acetylene and ethylene being at the highest condition level 4, which negatively impacts the oil dielectric
 - Major carbonization of the insulating paper as occurred from these numerous through fault events, indicating that this unit is near the end of its useful life
 - There is a bad fan on transformer #4, on the bottom of cooling group 2
- Grounding Bank #3
 - Upward trending of oil moisture content resulting in downward trending to the oil dielectric strength
 - Increasing moisture content is a resultant of water ingress and/or break down of paper insulation of TF windings
 - Short circuit strength breakdown caused by the amount of thermal through fault events
- Existing Gr. SW. MOAB configuration on the 138/46 kV and 138/34.5 kV transformers create faults in the station; known safety hazard in legacy station designs
- 63 of the 74 relays in the station (85% of all station relays) are of the electromechanical type which have significant limitations with regards to fault data collection and retention
- 13.2kV CBs R & S are oil filled breakers without oil containment

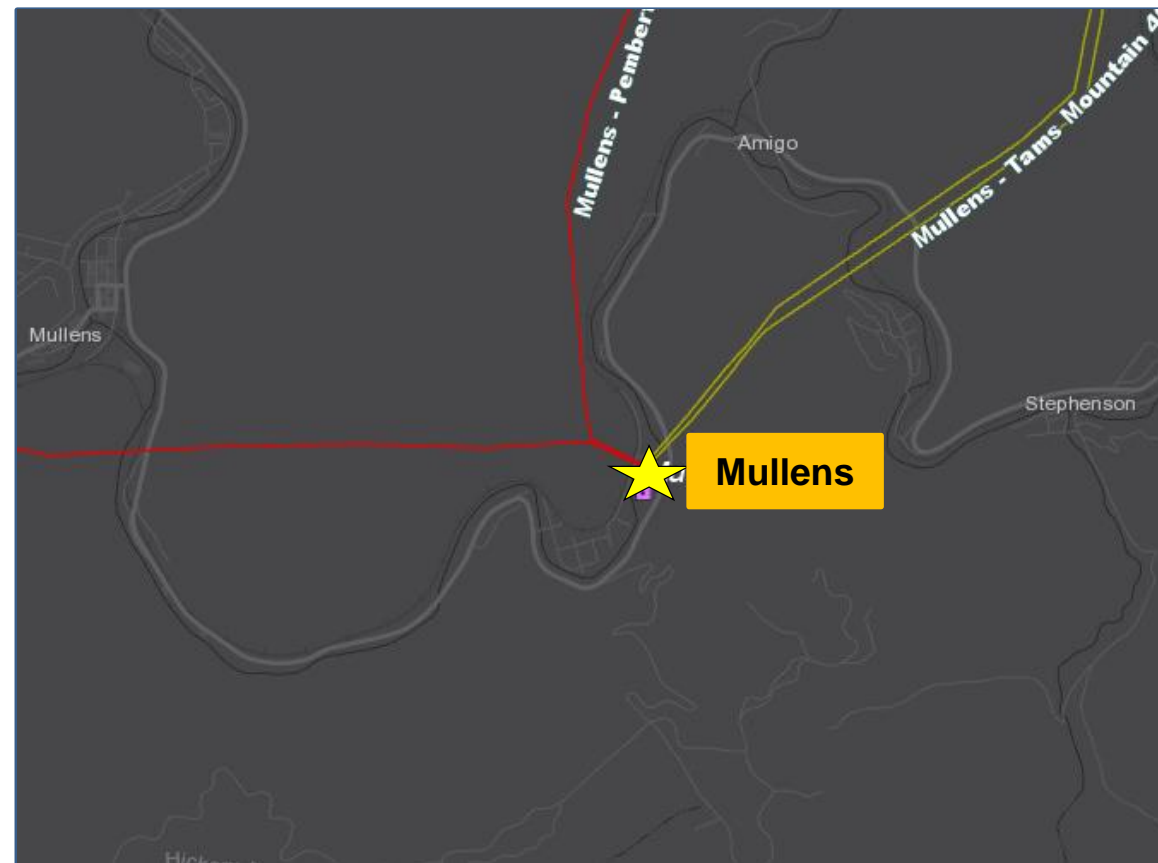

Need Number: AEP-2019-AP002

Process Stage: Submission of Supplemental Project for inclusion in the Local Plan 10/14/2020

Selected Solution:

138/46 kV transformer #4 is being replaced, including a high side circuit breaker, under PJM baseline project B3116.

Replace existing grounding bank with a new grounding bank. Install high side circuit breaker the existing 138/34.5 kV transformer. Install a new 138 kV 3000 A 40 kA circuit breaker towards Wyoming station. Install a new DICM. **(S2347)**

Estimated Cost: \$6.7 M

Projected In-Service: 2/17/2022

Supplemental Project ID: S2347

Project Status: Scoping

Model: N/A

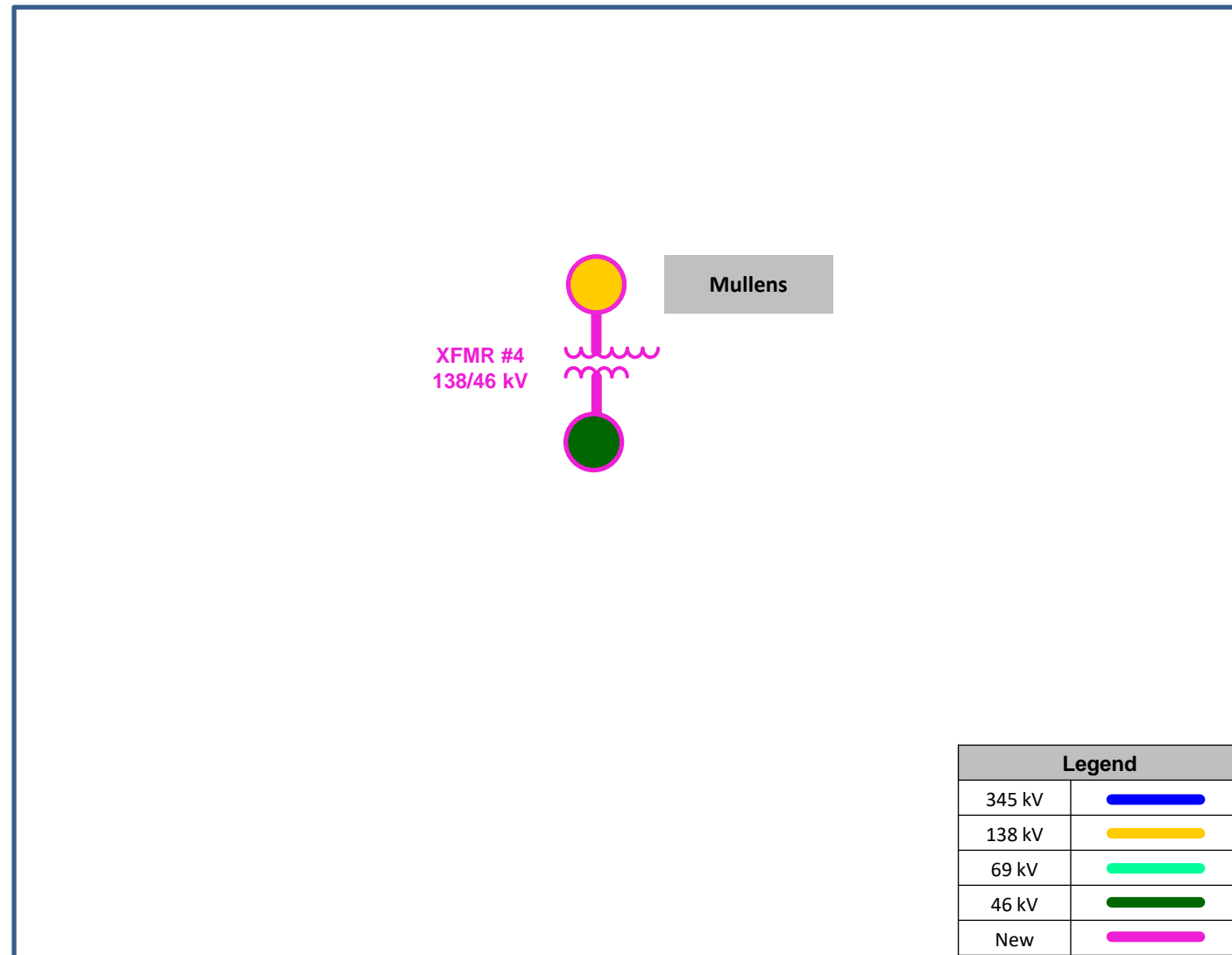

Need Number: AEP-2020-OH002

Process Stage: Submission of Supplemental Project for inclusion in the Local Plan 10/14/2020

Previously Presented:
Needs Meeting 01/17/2020
Solutions Meeting 07/17/2020

Project Driver:
Customer Service

Specific Assumption Reference:
AEP Guidelines for Transmission Owner Identified Needs (AEP Assumptions slide 7)

Problem Statement:
AEP Ohio is requesting a new 138kV delivery point on the Academia – North Lexington 138 kV circuit by May 2023. Anticipated load is approximately 15 MVA.

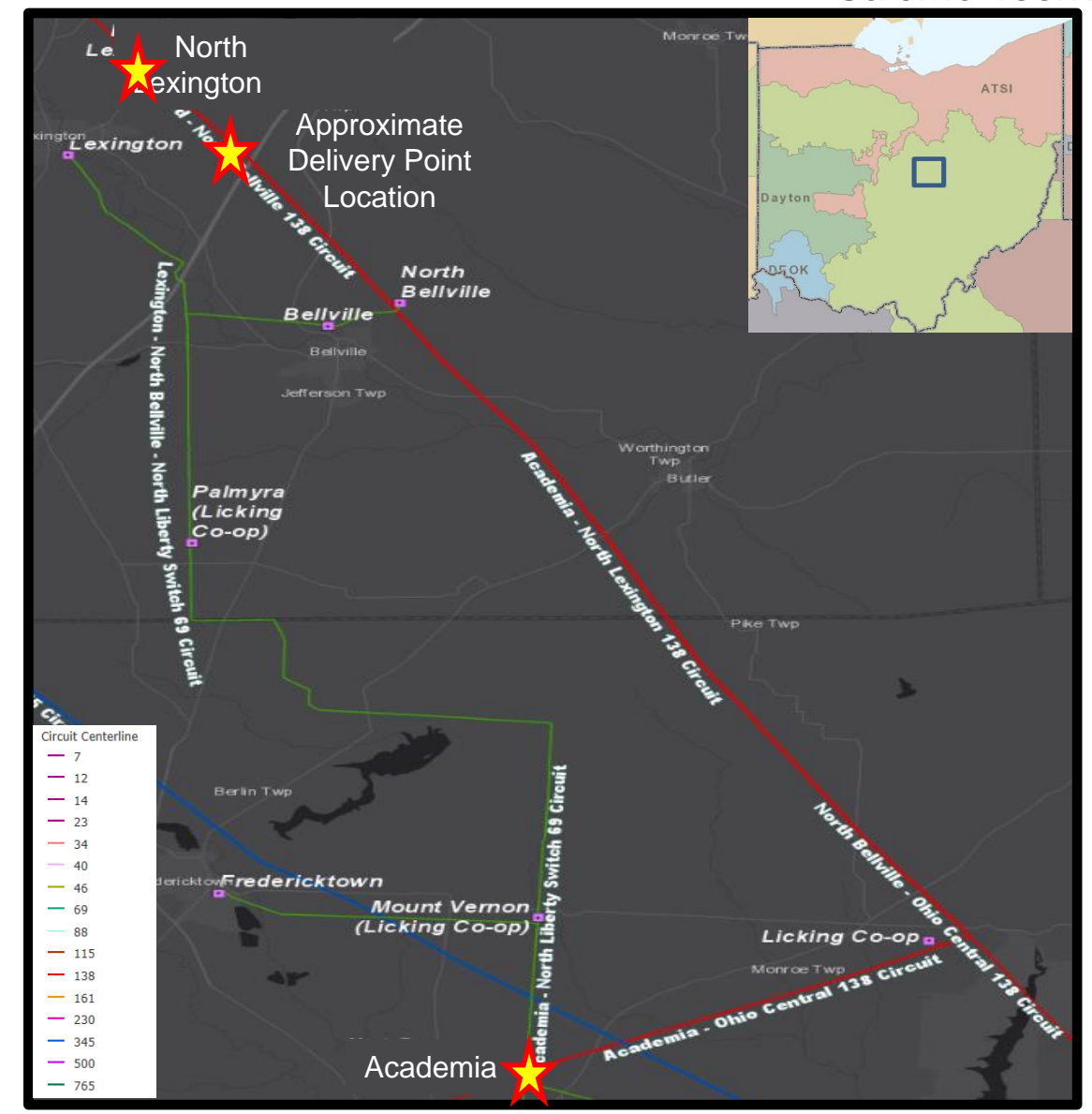

Need Number: AEP-2020-OH002

Process Stage: Submission of Supplemental Project for inclusion in the Local Plan 10/14/2020

Selected Solution:

- Install a greenfield 138kV in-out station (“Salerno”) with one auto sectionalizing switch on the line exit towards Academia one non-auto sectionalizing switch on the line exit towards North Lexington. **(S2343.1) Estimated Cost: \$1.4M**
- Install two 138kV single circuit lines, approximately 0.1 miles each, to tie the greenfield Salerno station to the Academia-North Lexington 138kV circuit with 795 ACSR. **(S2343.2) Estimated Cost: \$0.6M**
- Remove/Relocate approximately 0.1 mile of line on the Philo – Howard Line asset. Install ~1.7 miles of fiber to provide SCADA connectivity to Salerno. **(S2343.3) Estimated Cost: \$0.3M**

Total Estimated Transmission Cost: \$2.3M

Projected In-Service: 05/16/2022

Supplemental Project ID: S2343.1 - .3

Project Status: Scoping

Model: 2024 RTEP

Existing:



Proposed :

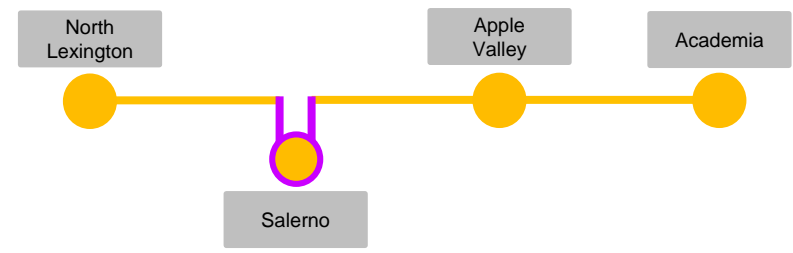

Legend	
500 kV	
345 kV	
138 kV	
69 kV	
34.5 kV	
23 kV	
New	

AEP Transmission Zone M-3 Process Main Street-Riverside 34.5kV Line Rebuild

Need Number: AEP-2020-IM002

Process Stage: Submission of Supplemental Project for inclusion in the Local Plan 10/14/2020

Previously Presented:

Needs Meeting 02/21/2020

Solution Meeting 07/17/2020

Project Driver:

Equipment Condition/Performance/Risk

Specific Assumption Reference:

AEP Guidelines for Transmission Owner Identified Needs (AEP Assumptions Slide 8)

Problem Statement:

Main Street-Riverside 34.5kV line:

- 4.1 miles of the 4.6 mile 34.5kV line from Main St. –Riverside 34.5kV:
 - 1930's double circuit steel lattice towers and 1950's wood pole line with cross arm construction
 - 15 structures with at least one open condition (21% of the line)
 - Open conditions include pole leaning, rot, woodpecker or insect damage

Riverside Station:

- There are (2) 34.5kV oil filled breakers of FK-type 1960's vintage
 - Circuit breaker G has exceeded it's manufacturer designed number of fault operations
 - The common failure mode documented by AEP are compressor failures and valve defects which cause low pressure and oil leaks
 - The manufacturer no longer provides support for this fleet of circuit breakers. Spare parts are not available.

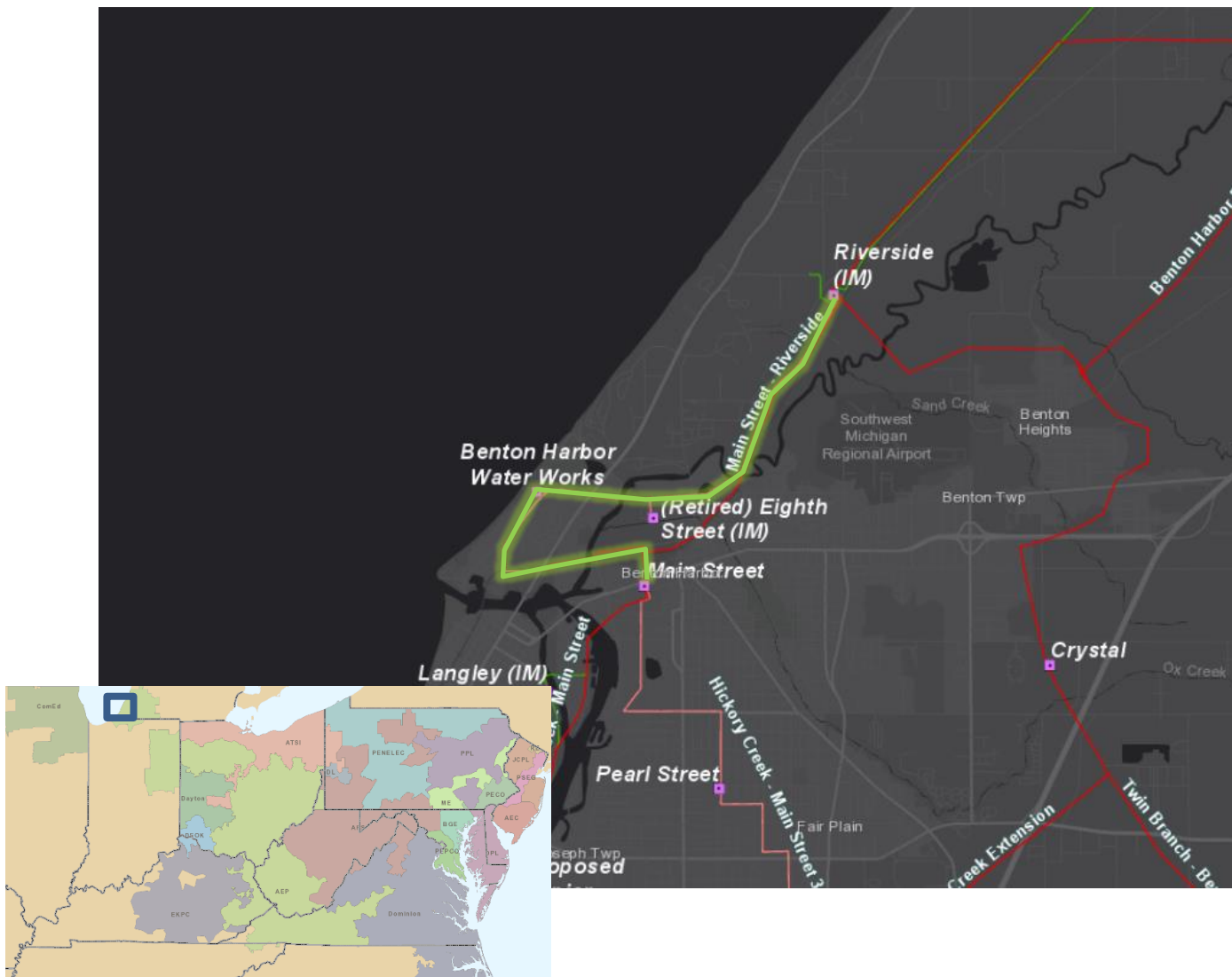

AEP Transmission Zone M-3 Process Main Street-Riverside 34.5kV Line Rebuild

Need Number: AEP-2020-IM013

Process Stage: Submission of Supplemental Project for inclusion in the Local Plan 10/14/2020

Previously Presented:

Needs Meeting 03/19/2020

Solutions Meeting 07/17/2020

Project Driver:

Equipment Condition/Performance/Risk

Specific Assumption Reference:

AEP Guidelines for Transmission Owner Identified Needs (AEP Assumptions Slide 8)

Problem Statement:

Riverside Station:

- (2) 138kV Breakers "O" & "A"
 - 1988 vintage SF-6 filled breakers
 - The breaker type has hydraulic leak issues on internal mechanisms which are caused by porous cylinder blocks and chips in the seal groove on the spring connecting rods.
 - Breaker A has operated for a fault 17 times exceeding its manufacturer recommendation of fault operations (10)

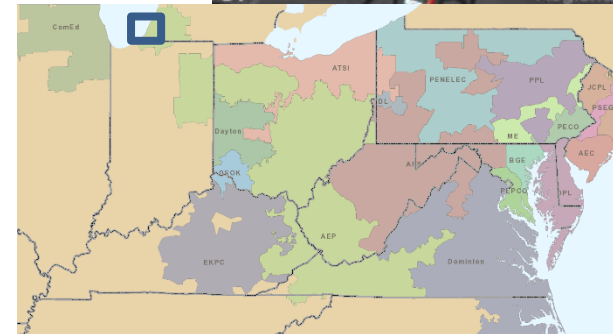

AEP Transmission Zone M-3 Process Main Street-Riverside 34.5kV Line Rebuild

Need Number: AEP-2020-IM002, AEP-2020-IM013

Process Stage: Submission of Supplemental Project for inclusion in the Local Plan 10/14/2020

Selected Solution:

Main St.-Riverside 34.5kV line:

Rebuild on center line approximately 4.1 miles of Main St-Riverside 34.5kV line with DOVE 556.5 ACSR 26/7. **(S2345.1) Estimated Cost: \$13.3M**

Riverside Station:

Replace (2) 138kV breakers and (2) 34.5kV breakers at Riverside. While at the station and taking advantage of the outage AEP will install a new 34.5kV breaker to bring Whirlpool customer, whose delivery point is currently one tower outside of the station, into Riverside station. Install high side circuit switcher to 138/69-34.5kV transformer. **(S2345.2) Estimated Cost: \$3.3M**

Estimated Cost: \$16.6 M

Projected In-Service: 02/14/2024

Supplemental Project ID: S2345.1 -2

Project Status: Scoping

Model: N/A

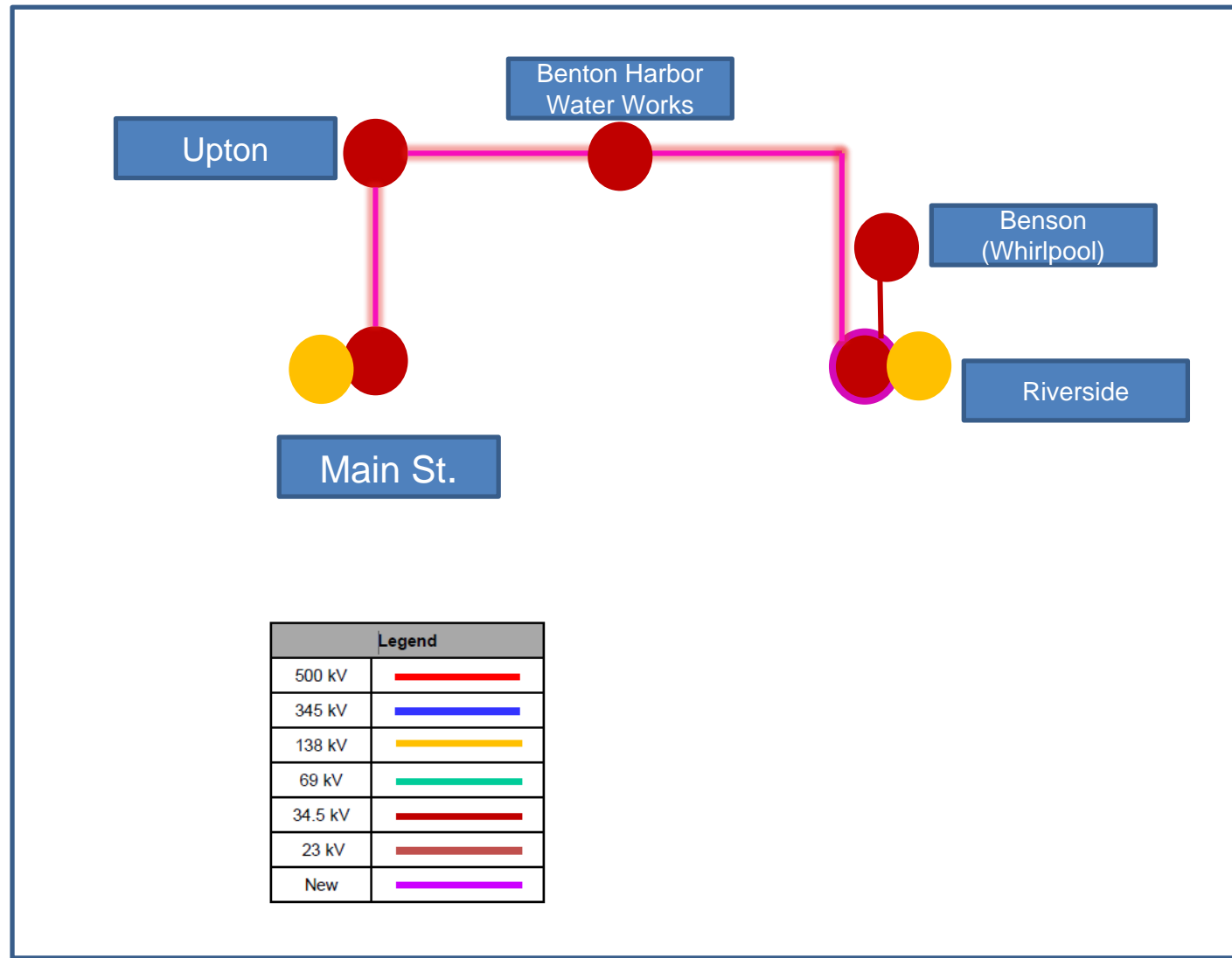

AEP Transmission Zone M-3 Process Baileysville Station project

Need Number: AEP-2020-AP007

Process Stage: Submission of Supplemental Project for inclusion in the Local Plan 10/14/2020

Previously Presented:

Needs Meeting 02/21/2020

Solution Meeting 07/17/2020

Project Driver:

Equipment Material/Condition/Performance/Risk

Specific Assumption Reference:

AEP Guidelines for Transmission Owner Identified Needs (AEP Assumptions Slide 8)

Problem Statement:

- Baileysville Station
 - 138 kV circuit breakers G, H, I, K, L and N are SF6 filled type breakers, the only 6 of this specific type on AEP's system
 - Vintage 1980s
 - Limited manufacturer support
 - Obsolete parts that are not available for replacement.
 - 46 kV CS AA is an SF6 filled 2030-69 type circuit switcher
 - Vintage 1990s
 - S&C 2030 circuit switcher has no gas monitor and sister units have a history of malfunctions
 - 138 kV CS CC is an SF6 filled MARK V-138 type circuit switcher.
 - Vintage 1990s
 - This type of switcher have presented AEP with a large amount of failures and mis-operations.
 - Mark V family has no gas monitor
 - Currently 79% of the relays at Baileysville Station are in need of replacement
 - 28 electromechanical and 8 static type relays
 - These type of relays have limitations with regard to fault data collection and retention.
 - Capacitor Bank BB, vintage 1976, has blown fuses and defective cans.
 - The station has seen significant flooding; as recently as 2009 the entire station flooded. In 2001, the control house was flooded with 1.5 feet of water.
 - The station has insufficient room for safe ingress/egress and for accessing equipment around the station

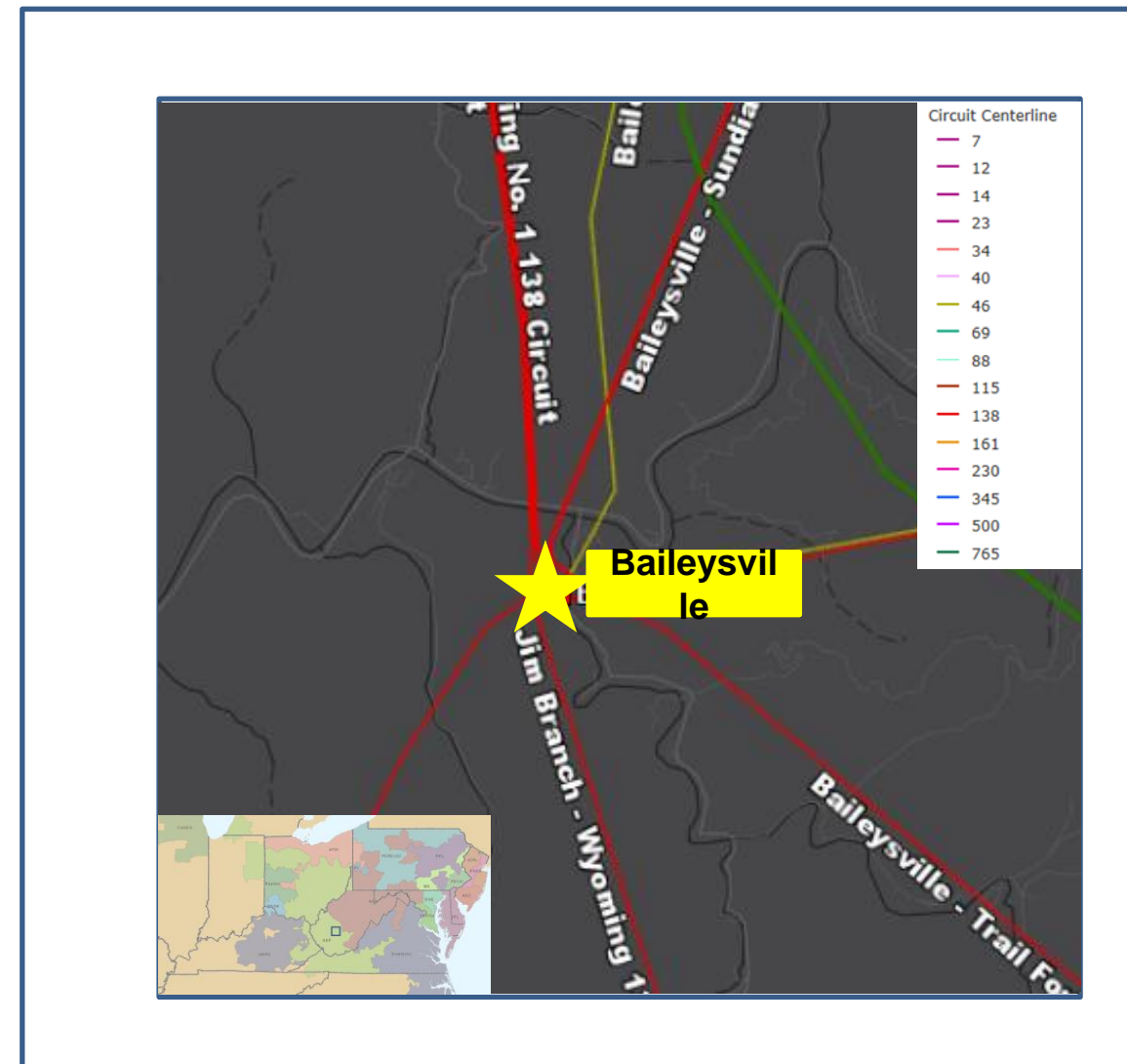

AEP Transmission Zone M-3 Process Baileysville Station project

Need Number: AEP-2020-AP007

Process Stage: Submission of Supplemental Project for inclusion in the Local Plan 10/14/2020

Selected Solution:

Replace existing 138 kV CBs G, H, I, K, L and N with six new 138 kV 40 kA circuit breakers. Replace existing 138 kV cap bank BB and install a new 138 kV breaker on the new cap bank. Replace existing 46 kV cap bank switcher with a new cap bank switcher. Install a high side circuit switcher on the existing 138/46 kV transformer. Upgrades will be made to the existing road into the station to improve access and space constraints. A flood wall will be installed to mitigate flooding concerns. *Note: 138 kV CS CC failed and has been replaced. **(S2346)**

Estimated Cost: \$10.1 M

Projected In-Service: 7/1/2022

Supplemental Project ID: S2346

Project Status: Scoping

Model: N/A

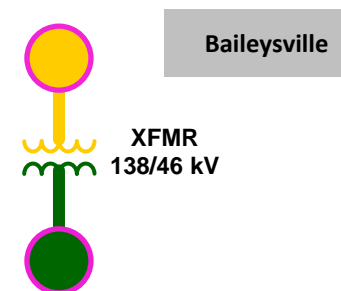

AEP Transmission Zone M-3 Process Colony Bay – Melita 69kV Line Rebuild

Need Number: AEP-2020-IM015

Process Stage: Submission of Supplemental Project for inclusion in the Local Plan 10/14/2020

Previously Presented:

Needs Meeting 4/20/2020

Solutions Meeting 7/17/2020

Project Driver:

Equipment Material/Condition/Performance/Risk

Specific Assumption Reference:

AEP Guidelines for Transmission Owner Identified Needs (AEP Assumptions Slide 8)

Problem Statement:

Colony Bay – Melita 69kV (5.8 miles)

- The Colony Bay – Melita circuit has ~5.8 miles of primarily 1960 wood pole structures
- This section has 34 open conditions across 26 unique poles (~17% of line). These conditions include, but aren't limited to Stolen/broken ground leads, broken insulators, damaged and rotting poles.
- An additional 23 poles on this section (~15%) were found to be decayed to the point of failure. These poles had steel reinforcers installed to allow them to last until a more permanent fix was available.
- The 2014-2019 5 year period this line was subject to 3 momentary outages and 3 permanent outages.

Hadley 69kV station

- Station has a bus tie switch that breakers the bus differential. AEP has been addressing these as we have the opportunity

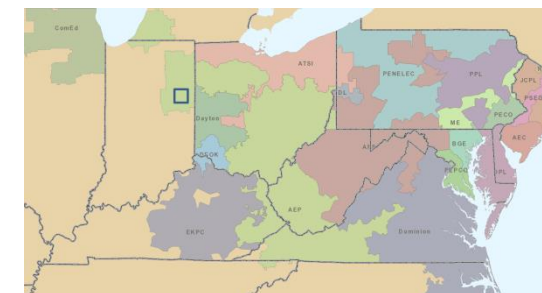
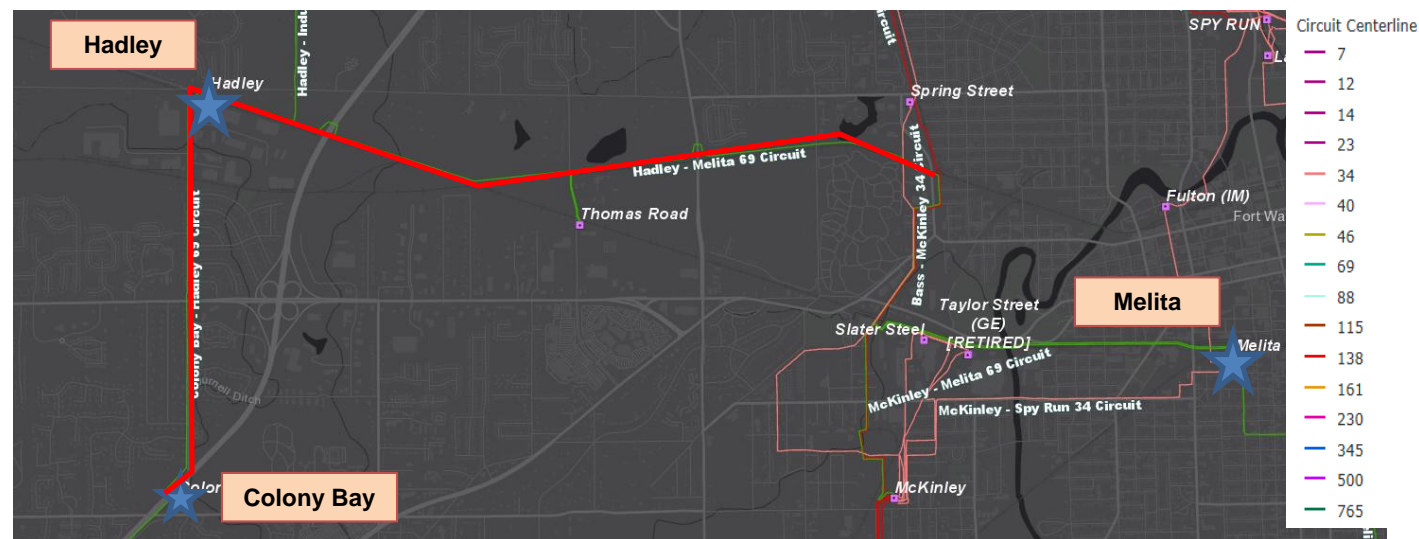

Need Number: AEP-2020-IM015

Process Stage: Submission of Supplemental Project for inclusion in the Local Plan 10/14/2020

Selected Solution:

Rebuild the ~5.8 mile 69kV line from Colony Bay to the McKinley – Bass line. (**S2344.1**) **Estimated Cost: \$14.8M**

Add a 69kV bus tie CB to Hadley station. (**S2344.2**) **Estimated Cost: \$0.8M**

Total Estimated Transmission Cost: \$15.6 M

Projected In-Service: 4/3/2023

Supplemental Project ID: S2344.1 - .2

Project Status: Scoping

Model: N/A

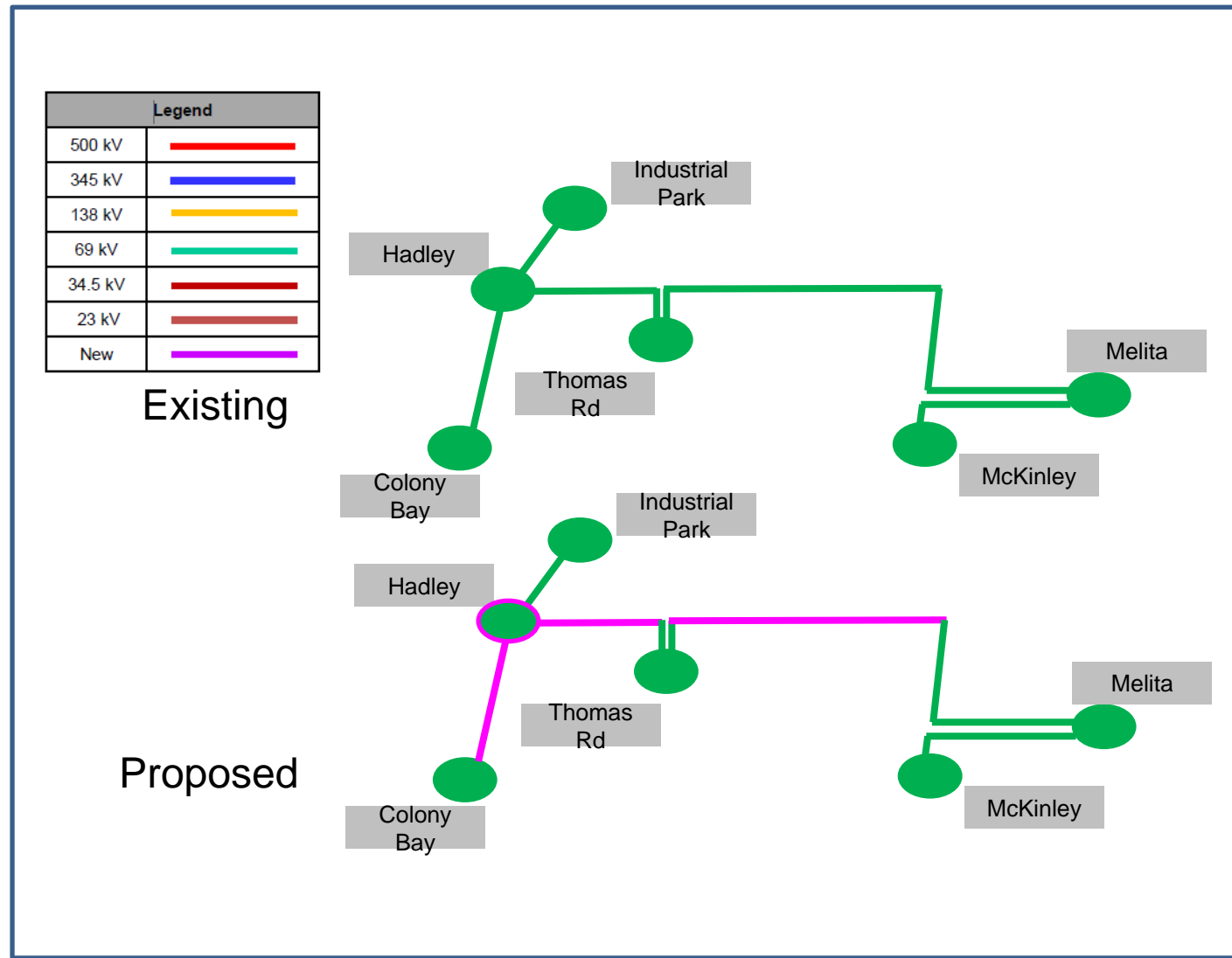

AEP Transmission Zone M-3 Process Twin Branch Hydro 34.5kV Solution

Need Number: AEP-2019-IM044

Process Stage: Submission of Supplemental Project for inclusion in the Local Plan 10/20/2020

Previously Presented:

Needs Meeting 11/22/2019

Solutions Meeting 08/14/2020

Project Driver:

Equipment Material/Condition/Performance/Risk

Specific Assumption Reference:

AEP Guidelines for Transmission Owner Identified Needs (AEP Assumptions Slide 8)

Problem Statement:

Twin Branch Hydro 34.5kV Station:

34.5kV Breakers:

- The 34.5 kV Circuit Breakers CB, BB, DD, HH, and NN at Twin Branch 34.5kV Station are GE 'FK' oil-filled breaker manufactured in the 1950's. Common failure modes documented in AEP malfunction records for these breaker types are:
 - compressor failures and valve defects, which cause low pressure and oil leaks.
 - trip or reclose failures, caused primarily by spring latching and charging motor component failures.
 - the vacuum oil and oil breakers have a lot of oil contamination from aging gaskets allowing moisture and other particle ingress.
- Oil spills are frequent with failures and routine maintenance, which can also present an environmental hazard
- Because these breaker types are no longer manufactured, spare parts are not available.

34.5/4kV Transformer #4:

- The interfacial tension of the oil is below acceptable limits and the moisture content in the oil relates to a level of relative saturation. These indicate that:
 - sludge has formed in the radiators, core and coil.
 - high moisture levels in the oil and paper insulating materials.
 - the transformer oil is in poor quality to withstand dielectric events.
- Due to the age of this transformer, oil processing is not feasible option to extend the life of the unit.

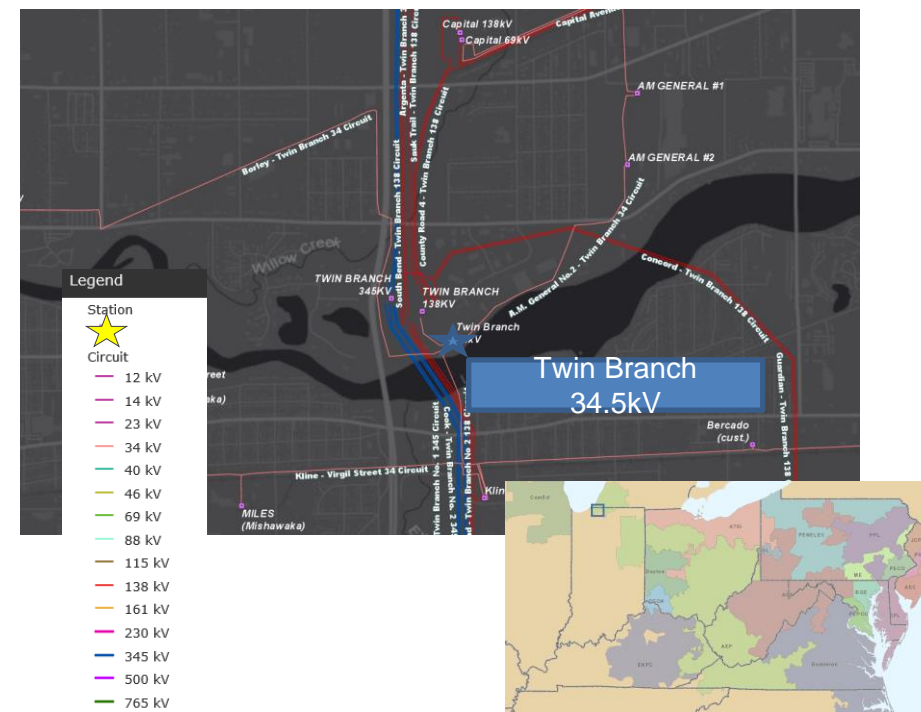

AEP Transmission Zone M-3 Process Twin Branch Hydro 34.5kV Solution

Need Number: AEP-2019-IM044

Process Stage: Submission of Supplemental Project for inclusion in the Local Plan 10/20/2020

Selected Solution:

Twin Branch Hydro 34.5kV Station:

Replace 34.5kV Breakers BB, CC, DD, HH, NN and 34.5kV/4kV Transformer #4 (**S2351**)

Estimated Cost: \$2.8M

Projected In-Service: 05/10/2022

Supplemental Project ID: S2351

Project Status: Scoping

Model: N/A

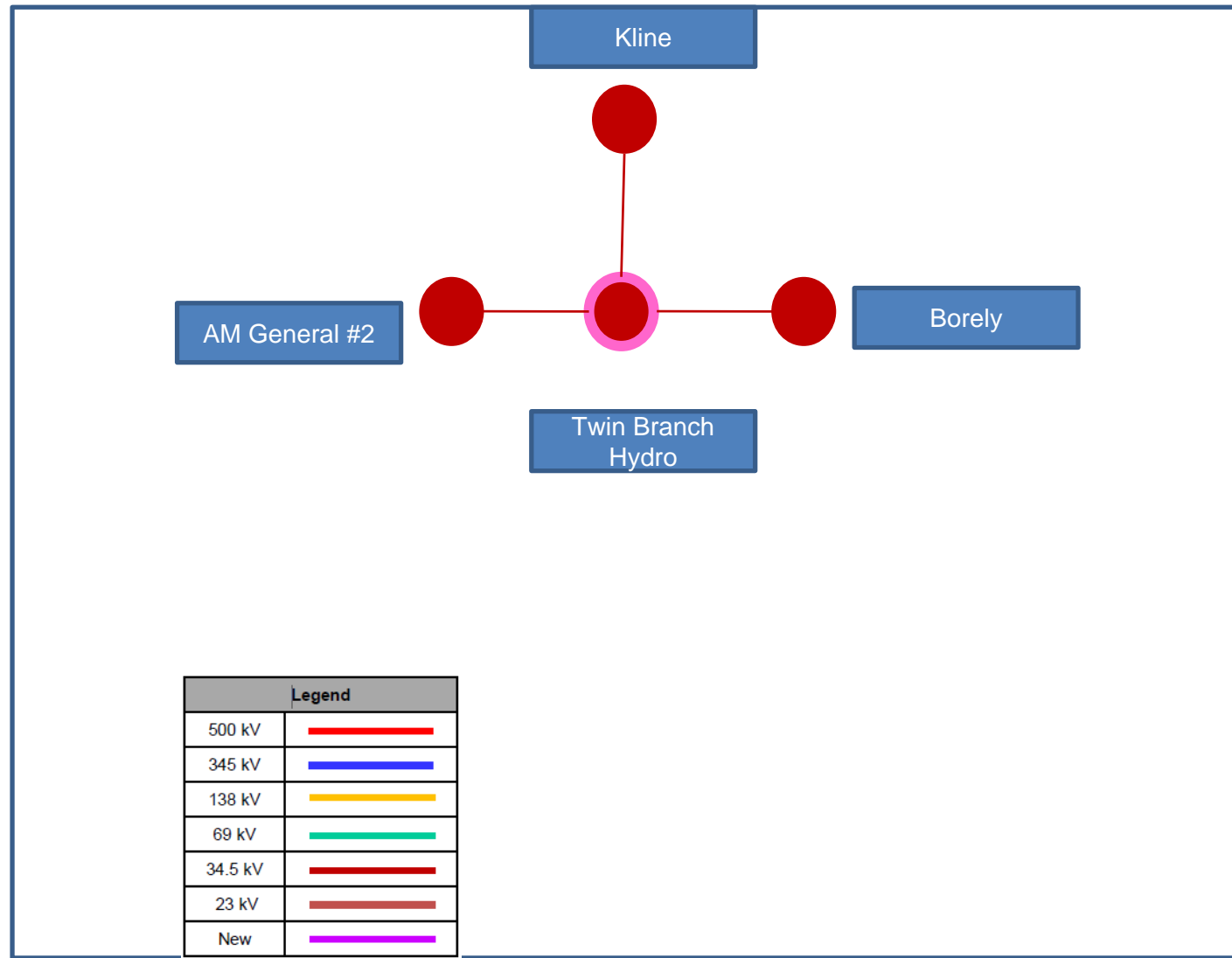

AEP Transmission Zone M-3 Process Lima Pumping Extension Rebuild

Need Number: AEP-2020-OH009

Process Stage: Submission of Supplemental Project for inclusion in the Local Plan 10/20/2020

Previously Presented:

Needs Meeting 2/21/2020

Solutions Meeting 8/14/2020

Project Driver:

Equipment Material/Condition/Performance/Risk, Operational Flexibility and Efficiency, Customer Service

Specific Assumption Reference:

AEP Guidelines for Transmission Owner Identified Needs

Problem Statement:

Equipment Material/Condition/Performance/Risk:

- This line consists of 15 wood pole structures and has predominantly the original #2 ACSR/AW Sparrow conductors installed in 1943. 9 out of the 15 structures on this line were installed more than 60 years ago. 5 year CMI on this circuit is approx. 95,000. The existing construction is obsolete crossarm construction with 35 kV vertical stud post insulators. A couple of the poles have shield wire support bay-o-nets.

Operational Flexibility and Efficiency

- The line has experienced four (4) conductor failures since August 1, 2018. The first 8 spans of the line have 35 total splices. In most cases the burned down 34.5 kV conductors end up falling into and faulting the AEP Ohio 3-phase distribution underbuild, interrupting several hundred additional distribution customers.

Customer Service:

- Marathon Pipe Line has experienced multiple outages to their facilities due to geese contact with AEP's 34.5 kV transmission line serving them and another customer. Additionally these two customers are connected off of a hard tap at the end of the radial 34.5 kV line forcing both of them to be out when one of them request and outage.

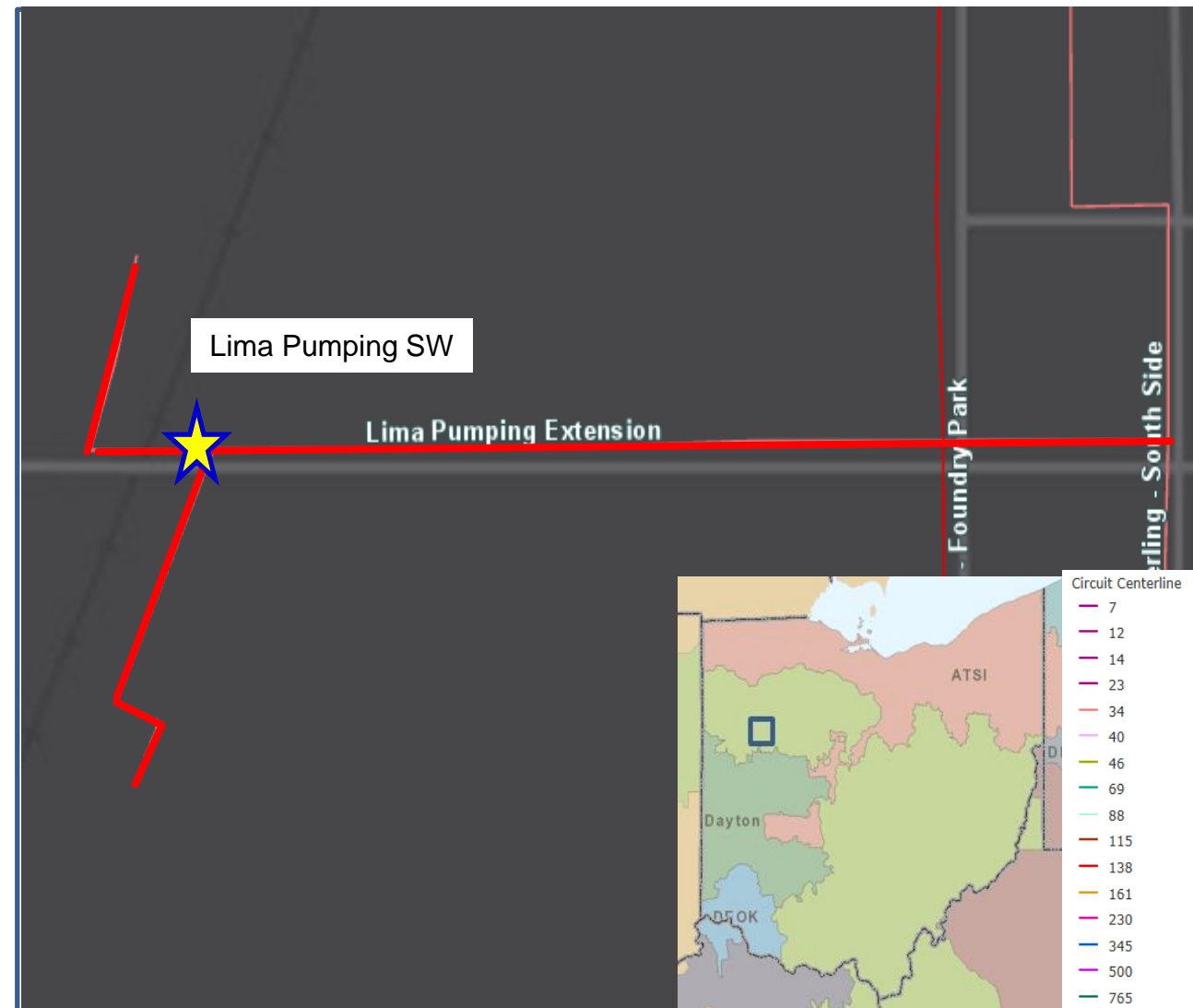

AEP Transmission Zone M-3 Process Lima Pumping Extension Rebuild

Need Number: AEP-2020-OH009

Process Stage: Submission of Supplemental Project for inclusion in the Local Plan 10/20/2020

Selected Solution:

- Rebuild the ~0.4 miles, 34.5 kV Lima Pumping Line Extension to 69 kV standards (operated at 34.5 kV). **(S2352.1) Estimated Cost \$2.3M**
- Rebuild the ~0.1 miles, 34.5 kV Ex-cell-o Line Extension to 69 kV standards (operated at 34.5 kV). **(S2352.2) Estimated Cost \$0.5M**
- **Lima Pumping Switch 34.5kV:** Install new 69 kV, 1200A, 40kA 3-way phase-over-phase manual switch on the Sterling – South Side Lima 34.5 kV circuit. **(S2352.3) Estimated Cost \$0.4M**
- **Airfoil Switch 34.5kV:** Install new 69kV, 1200A, 40kA 2-way Phase-over-phase manual switch on the Lima Pumping Extension. **(S2352.4) Estimated Cost \$0.6M**

Estimated Cost: \$3.8 M

Projected In-Service: 11/15/2021

Supplemental Project ID: S2352.1-.4

Project Status: Scoping

Model: 2023 RTEP

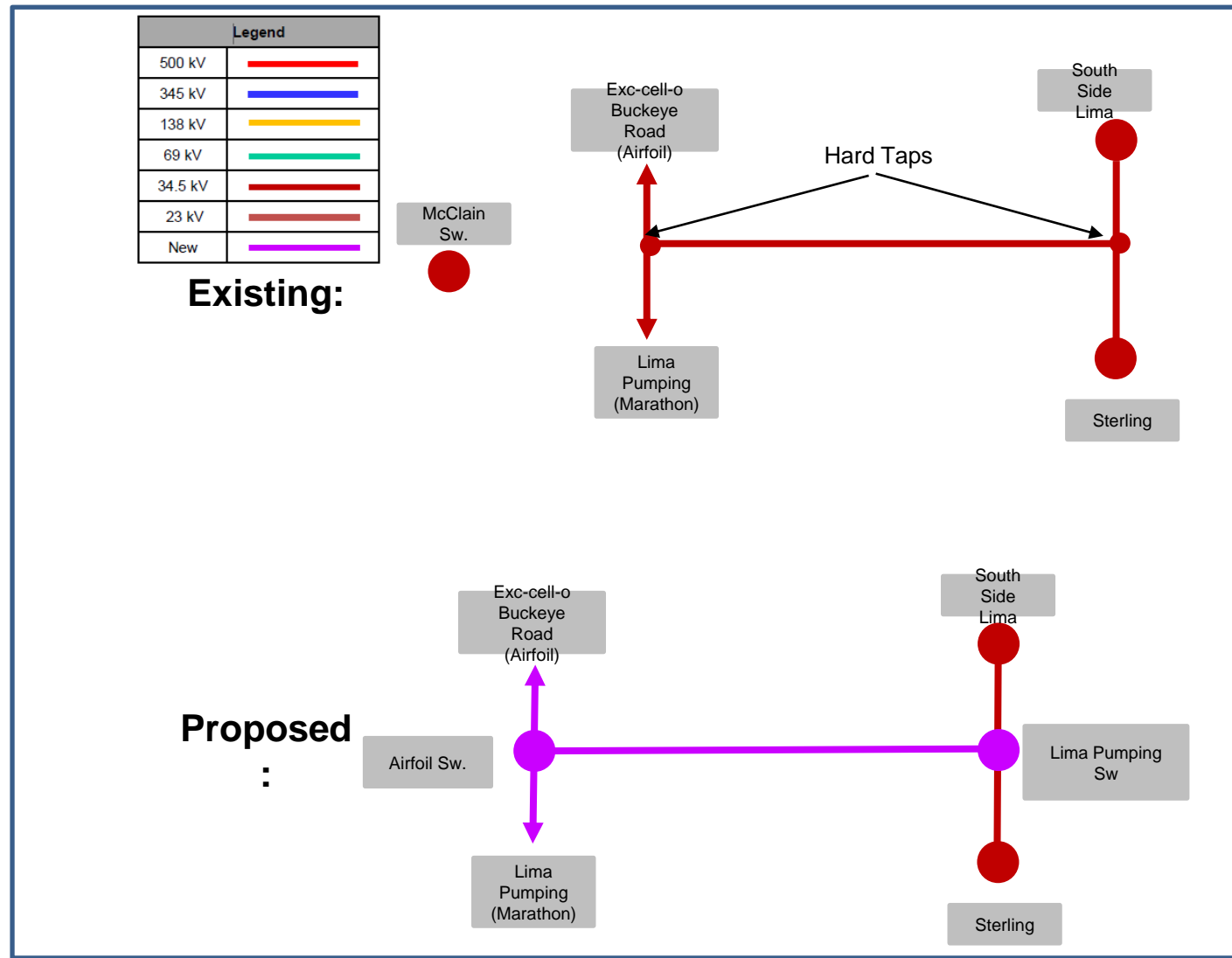

Revision History

- 1/29/2020 – V1 – Added from S2139.1-.7 to S2149.1-.33 (Slides #2-#33)
- 2/6/2020 – V2 – Added from S2151 to S2167.1-.11 (Slides #34 -#82)
- 2/27/2020 – V3 – Added from S2177.1-.8 to S2179.1-.34 (Slides #33 -#100)
- 3/12/2020 – V4 – Slide #36, Renumber S2166.1-.4 and correct the total cost.
 - Slide #59, Correct the typo (S2152 -> S2153)
- 4/10/2020 – V5 – Added from S2184.1-.8 to S2199.1-.17 (Slides #101 -#137)
- 4/20/2020 – V6 – Added from S2200.1-.3 to S2201.1-.3 (Slides #138 -#141)
- 5/13/2020 – V7 – Added from S2212 to S2226.1-.3 (Slides #142 -#185)
 - Slide #117 and #118, changes are reflected in the slides
- 6/15/2020 – V8 – Added from S2248.1-.2 to S2253.1-.2 (Slides #186 -#198)
- 7/21/2020 – V9 – Slide #150, Corrected the Need number AEP-2019-AP022
 - Slide #161, Split S2213.6 into S2213.6 and S2213.11
- 8/6/2020 – V10 – Added from S2270.1-.7 to S2274 (Slides #199 -#215)
- 8/13/2020 – V11 – Slide #215, Renumber S2274 to S2274.1 and add S2274.2

Revision History

9/15/2020 – V12 – Added from S2280 to S2284.1-.8 (Slides #216-#227)

10/21/2020 – V13 – Added from S2343.1-.3 through S2348.1-.5, S2351 and S2352.1-.4 (Slides #228-#246)

10/26/2020 – V14 – Slides #228 -230, Corrected Solution Date from 6/19/2020 to 7/17/2020

– Slide #232, Corrected Solution Date from 5/22/2020 to 7/17/2020

11/2/2020 – V15 – Slides #137, Scope/Estimated Cost update for S2197 due to the partially conversion to baseline

9/29/2021 – V16 – Slides #117, Scope update for S2188.6 and .7 and changes are reflected in the slides

11/4/2021 – V17 – Slides #117v, Scope/cost/Project IS date updates are reflected in the slides