



TO/TOP Matrix V14

Srinivas Kappagantula, Chair TTMS
Operating Committee
January 9, 2020

Action Required	Deadline	Who May Be Affected
<p>Recommend TOA-AC to approve TO/TOP Matrix V14 with an effective date of 4/1/2020</p> 	<p>2/3/2020</p> 	<p>PJM Member Transmission Owners (TOs)</p> 

PJM TO/TOP Matrix

- Index between the PJM Manuals/Governing Documents and NERC Reliability Standards applicable to PJM as the TOP
- Delineates the Assigned/Shared Tasks for Member TOs where PJM relies on its TOs to perform certain tasks
- Does not create any new obligations for PJM or its Member TOs
- An efficient and effective tool fundamental to a strong PJM Internal Control – the PJM TO/TOP Reliability Audit Program

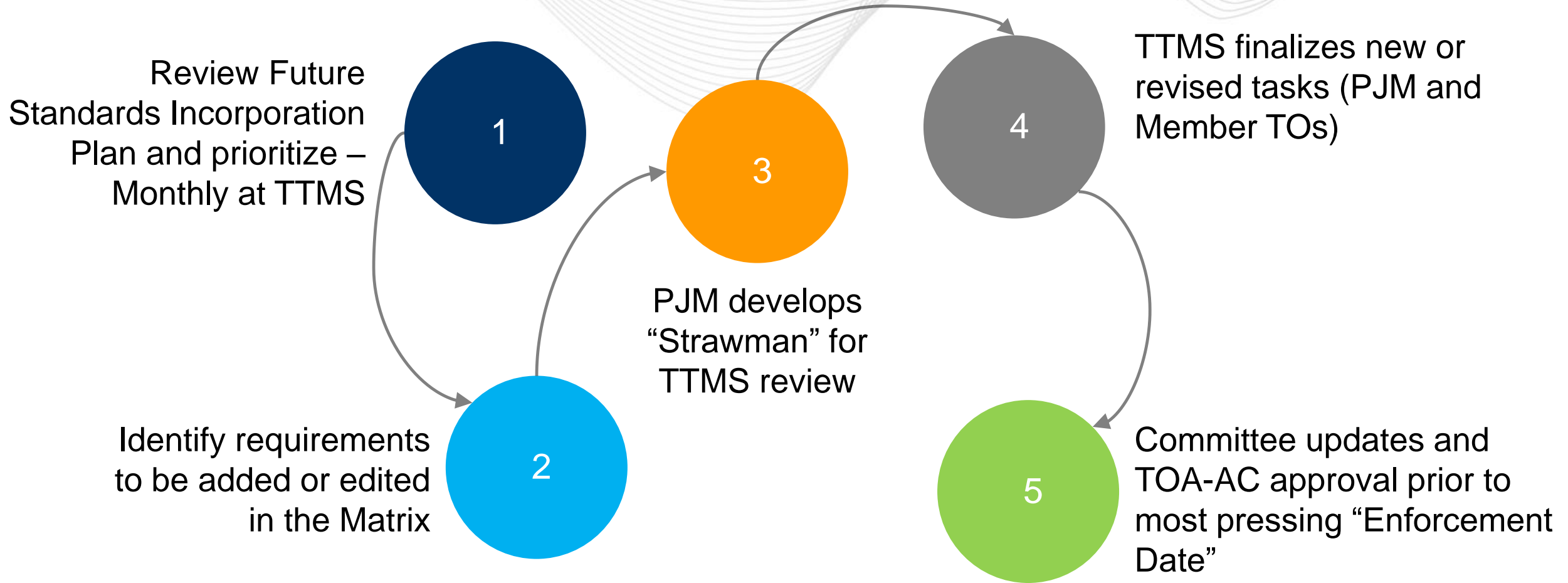

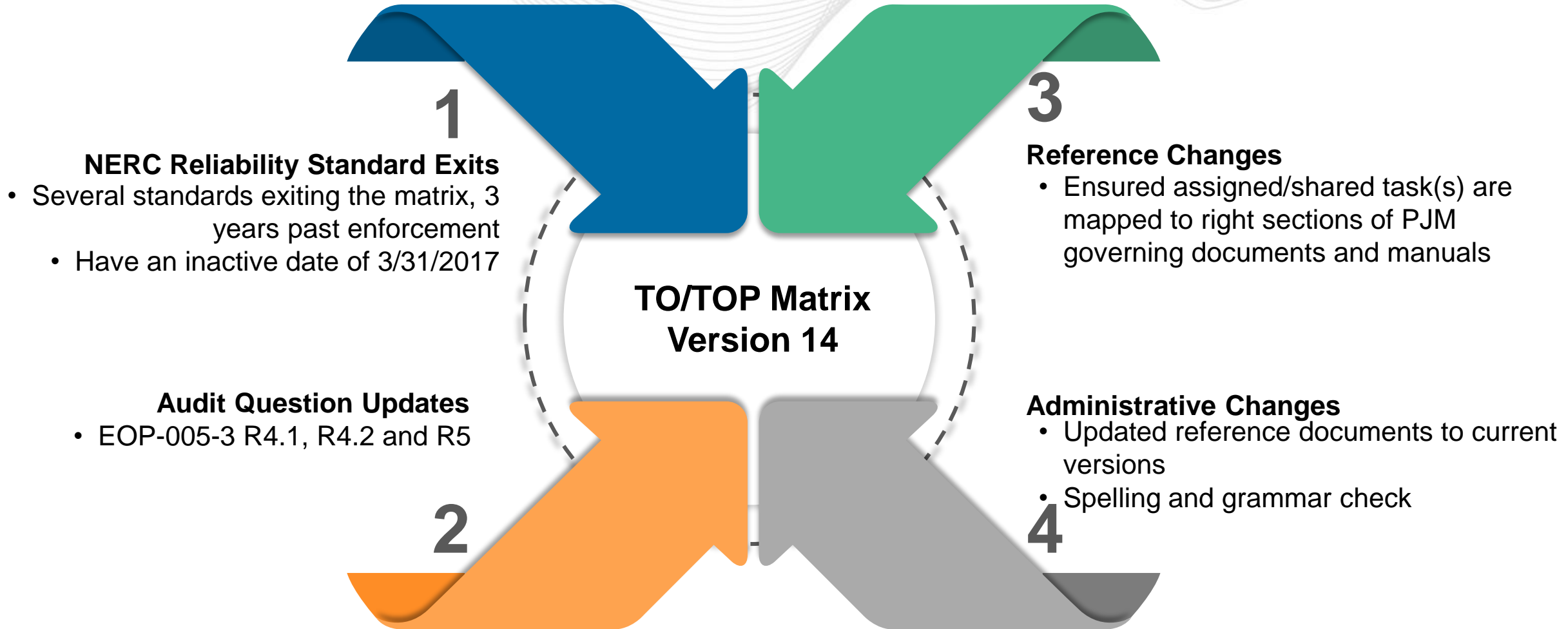

NERC Reliability Standard

- | | |
|-----------------|---|
| 1. COM-001-1.4 | 11. PRC-001-1.1(ii)
R2, R2.2, R5.2, R6 |
| 2. COM-002-2 | |
| 3. EOP-001-2.1b | 12. PRC-010-0 |
| 4. EOP-003-2 | 13. PRC-022-1 |
| 5. EOP-004-2 | 14. TOP-001-1a |
| 6. IRO-001-1.1 | 15. TOP-002-2.1b |
| 7. IRO-004-1 | 16. TOP-003-1 |
| 8. IRO-005-3.1a | 17. TOP-004-2 |
| 9. PER-001-0.2 | 18. TOP-006-2 |
| 10. PER-005-1 | 19. TOP-007-0 |
| | 20. TOP-008-1 |

Rationale for Inactive Standards in the Matrix

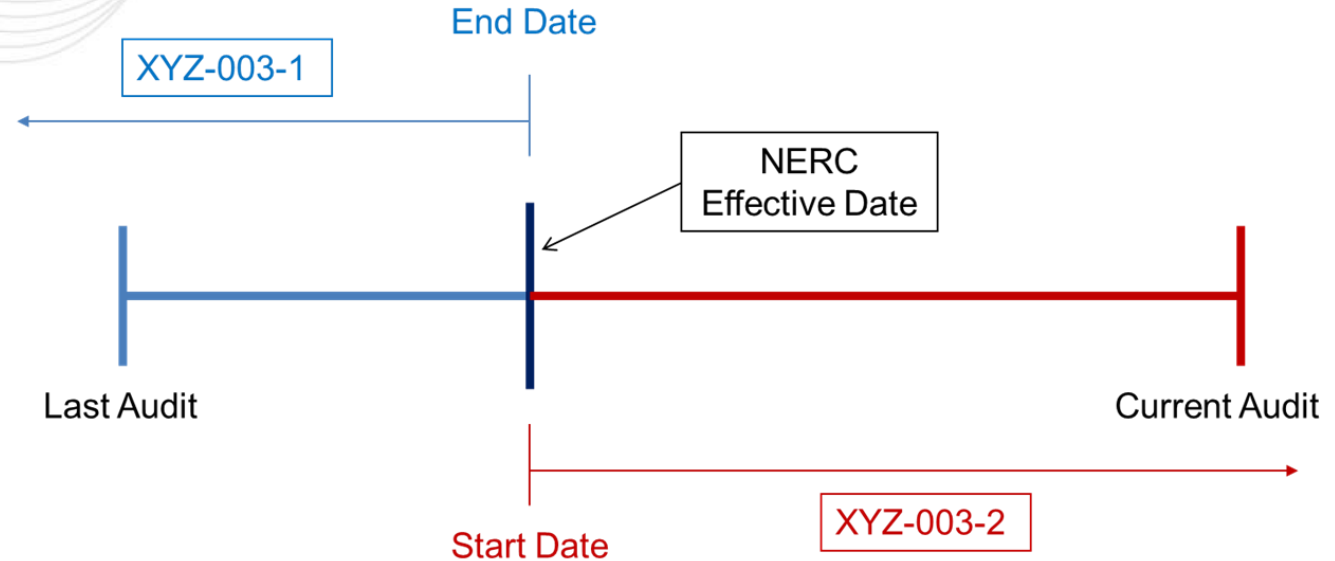

- Once a Standard has been inactive in the TO/TOP Matrix for 3 years, it gets deleted from the next version

Administrative Changes

- Updated all reference documents to their current versions and updated section titles as appropriate
- Spelling and grammar check

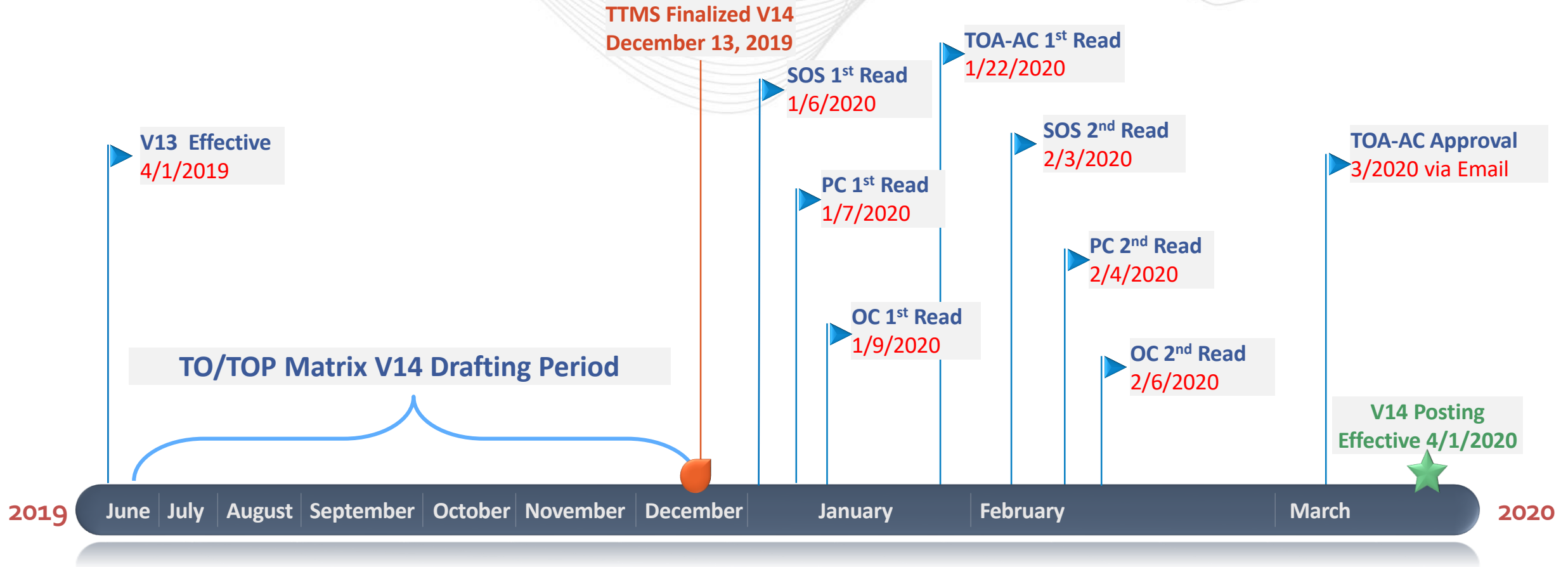

- Your recommendation to the Transmission Owner's Agreement-Administrative Committee to approve the TO/TOP Matrix V14 with an effective date of 4/1/2020

TO/TOP Matrix Educational/Background Slides

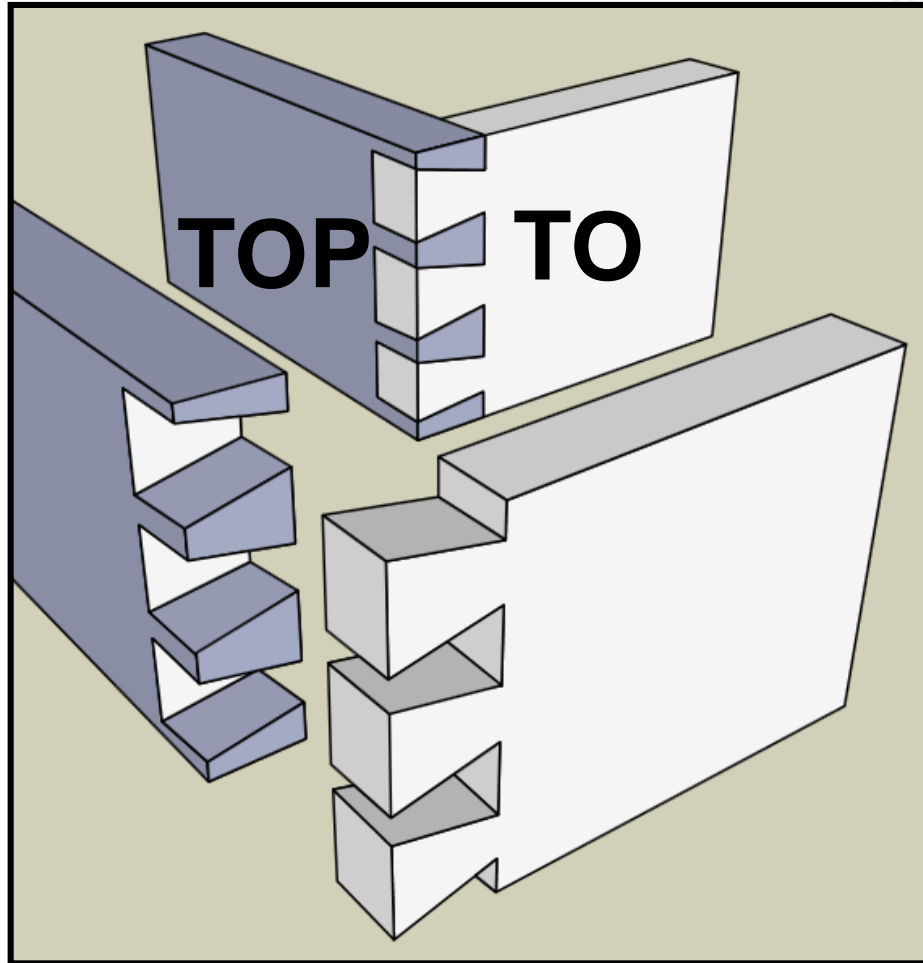

- Clear Responsibility and Authorities
 - Long Standing Relationship
 - Unity of Command and One Responsible Entity
 - Codified in PJM's Agreements
- PJM Committees (OC, SOS, PC...)
- Strong and proven Internal Control
 - PJM Training
 - TO/TOP Matrix
 - PJM TO/TOP Reliability Audits

**PJM Open Access
Transmission Tariff
(OATT)**



**PJM Operating
Agreement
(OA)**



**PJM Consolidated Transmission
Owners Agreement
(TOA)**



Filed with FERC

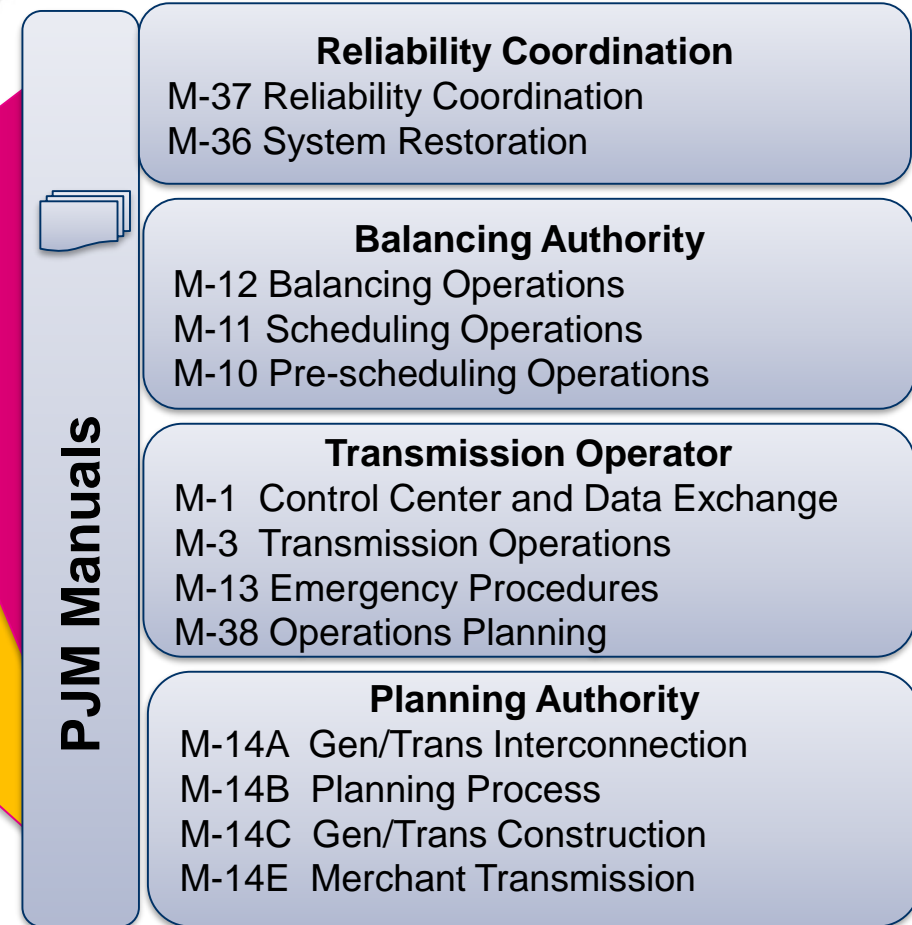

1

• Delineation of Reliability Tasks

Standard/ Requirement information

NERC Reliability Standard Requirement Text

Tasks Assigned to Member TOs or Shared between PJM and Member TOs

Tasks PJM performs to ensure Reliability Requirement is met in combination with TO Assigned/Shared Tasks

Category	Standard Number	Requirement Number	Approved BOT/FERC Standards	A/S	Assigned or Shared Member TO Tasks	PJM Tasks
EOP	EOP-005-2	R1	Each Transmission Operator shall have a restoration plan approved by its Reliability Coordinator. The restoration plan shall allow for restoring the Transmission Operator's System following a Disturbance in which one or more areas of the Bulk Electric System (BES) shuts down and the use of Blackstart Resources is required to restore the shut down area to service, to a state whereby the choice of the next Load to be restored is not driven by the need to control frequency or voltage regardless of whether the Blackstart Resource is located within the Transmission Operator's System. The restoration plan shall include: <i>[Violation Risk Factor = High] [Time Horizon =Operations Planning]</i>	S	<ol style="list-style-type: none"> 1. Each Member TO shall have a restoration plan that supports restoring the Transmission Operator's System following a Disturbance in which one or more areas of the Member TO's BES shuts down. 2. The Member TO shall send the Member TO restoration plan to PJM for approval. 	PJM will review, recommend revision, and/or approve submitted Member TO Restoration Plans.

2

• TO/TOP Audit Phase

Questions asked to demonstrate compliance

Examples of evidence auditors look for

PJM documents that describe PJM/TO responsibilities

Enforcement and Inactive dates of the NERC Reliability Standard

Audit Questions	Evidence of Compliance (What auditors will be looking for)	Reference Documents	Enforcement Date	Inactive Date
<p>1. Do you have a restoration plan that supports for restoring the Transmission Operator's System following a Disturbance in which one or more areas of the Member TO's BES shuts down? 2. Is it approved by PJM?</p>	<p>Exhibit your restoration plan and show that it covers a plan to reestablish its electric system in a stable and orderly manner in the event of a partial or total shutdown of its system, including necessary operating instructions and procedures to cover emergency conditions, and the loss of vital telecommunications channels. 2. Show evidence of approval by PJM.</p>	<p>M-36 System Restoration, Section 8-System Restoration Plan Guidelines; Section 1.1-Policy Statements, PJM Member Actions, Attachment G: Coordination of Restoration Plan with PJM Internal and External Neighboring Entities</p>	<p>7/1/2013</p>	<p>None</p>

- Evidence of compliance
- Formal delegation agreement
- Joint Registration Organization (JRO) or Coordinated Functional Registration (CFR)
- A means of creating new obligations for PJM or its Member TOs other than those specified in the PJM OATT, OA, CTOA, PJM Manuals and other governing documents
- A list of how all TOP requirements are met

- TO/TOP Matrix Subcommittee (TTMS), a PJM subcommittee with participation limited to Member TOs, develops and maintains the TO/TOP Matrix
- The TTMS reports to the Transmission Owners Agreement-Administrative Committee (TOA-AC), which approves the Matrix
- Monthly meetings to collaborate on new or existing NERC Reliability Standards applicable to PJM as the TOP

Typical Roadmap to a Version Approval

Review Future Standards Incorporation Plan and prioritize accordingly

Develop Assigned and/or Shared Tasks for NERC Reliability Standard Requirements where PJM relies on Member TOs

Conduct an annual review of the Matrix and agree to a final version for updates to various stakeholders

Take finalized version to PJM SOS, OC, and PC, seeking their recommendation to TOA-AC to approve the Matrix

TOA-AC approves the Matrix. Publish the approved Version.

Rationale for Inactive Standards in the Matrix

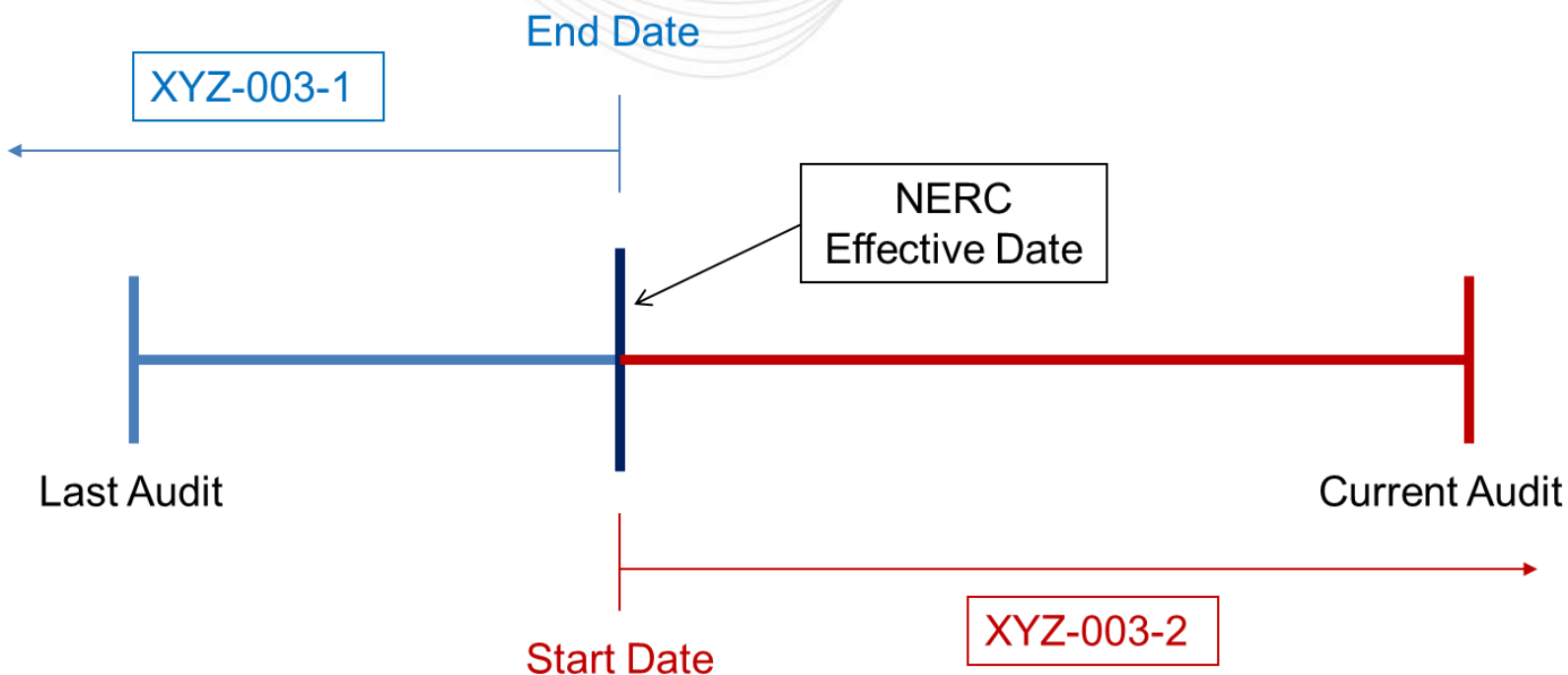

- Once a Standard has been inactive in the TO/TOP Matrix for 3 years, it gets deleted from the next version