

# Grid-Scale Energy Storage for Regulation Services

PJM Frequency Regulation

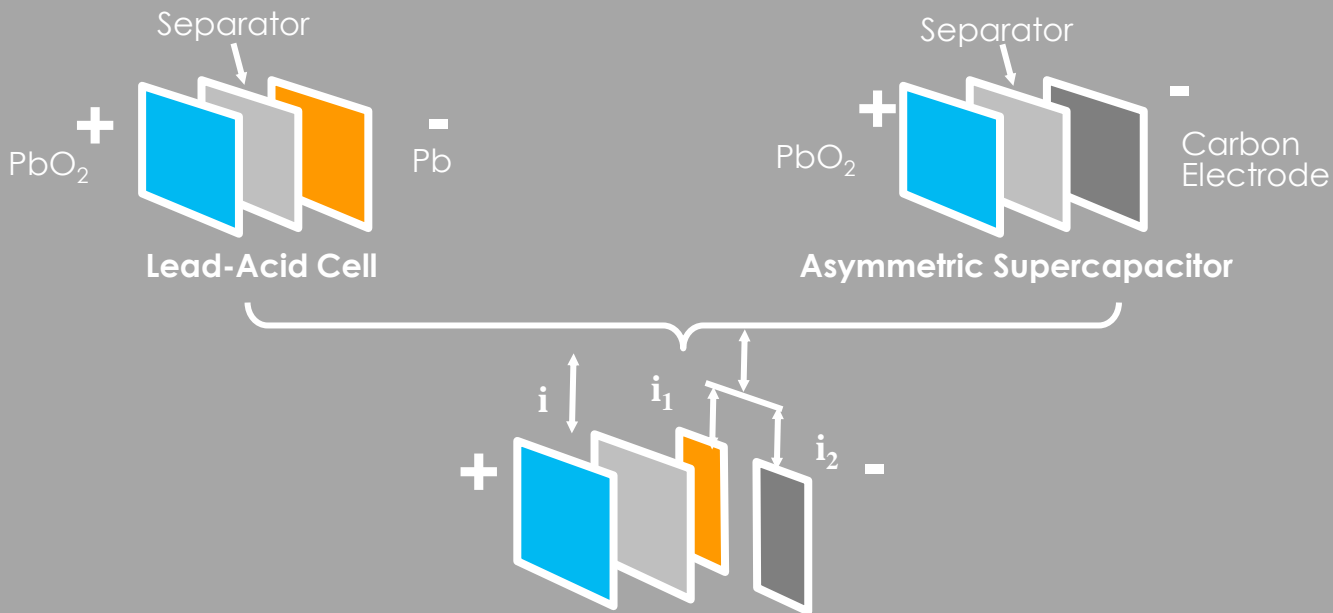

## UltraBattery® Technology



# UltraBattery®



The New Dimension in a Lead Acid World

**Starter  
Battery**

Market Size:  
**\$15B**

**Motive  
Battery**

Market Size:  
**\$3.5B**

**Standby  
Battery**

Market Size:  
**\$6B**

**PSOC  
UltraBattery**

New Lead-Acid  
Market

State of Charge

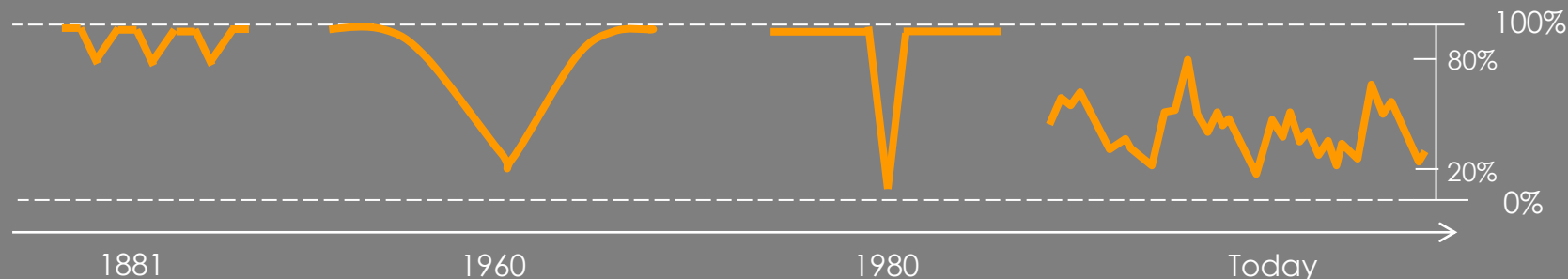

**EAST PENN manufacturing co., inc.**



# Variability Management



Intracycle

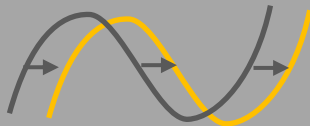

Regulation and Variability Management

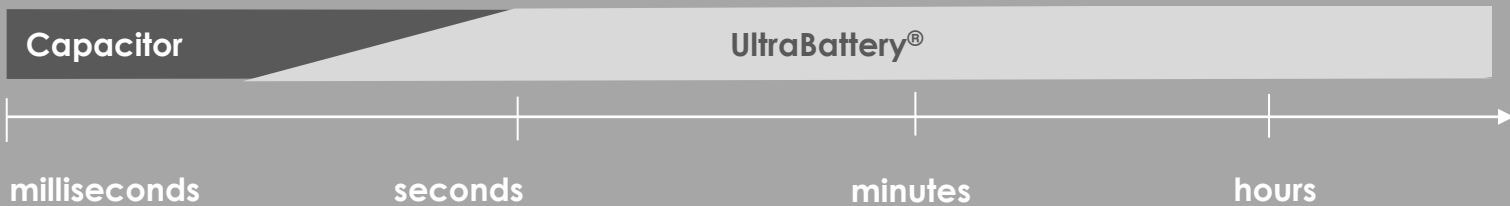

**EAST PENN** manufacturing co., inc.



# Partial State of Charge



Regulation Signal



Resulting Battery State of Charge

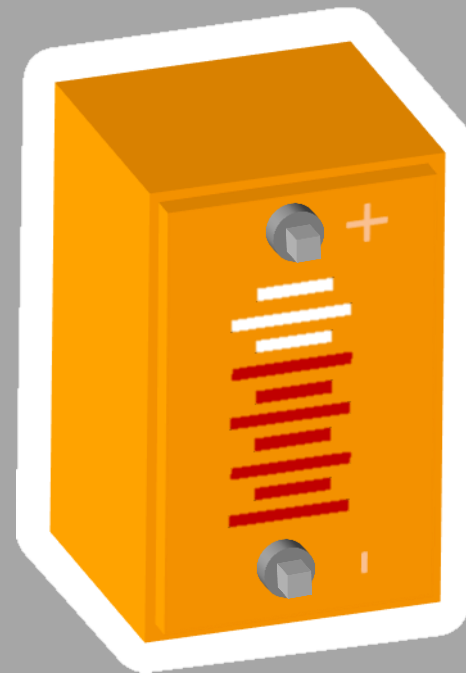
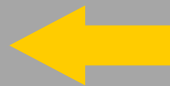
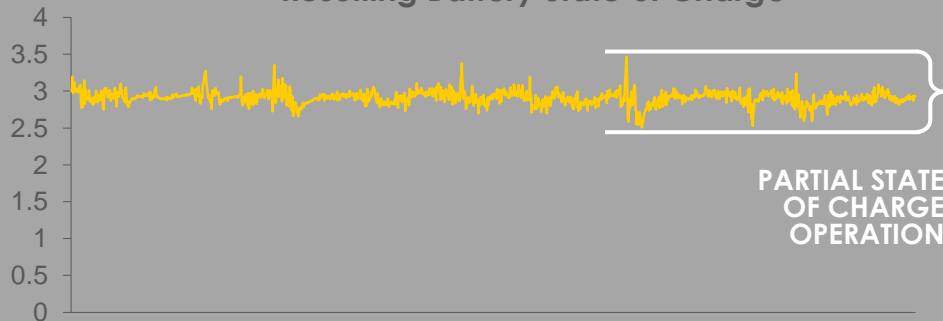

# UltraBattery®



## Partial State of Energy Storage

UltraBattery®

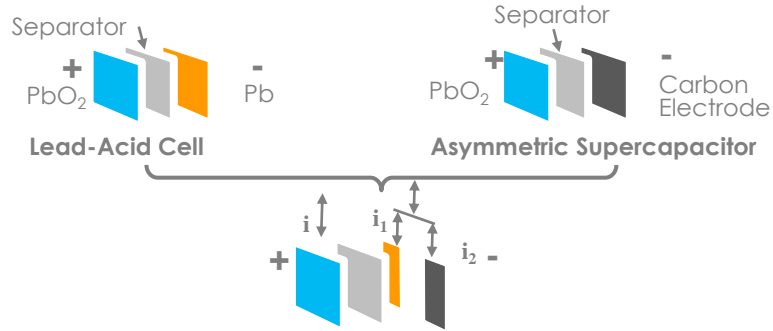

## Partial State of Charge Operation

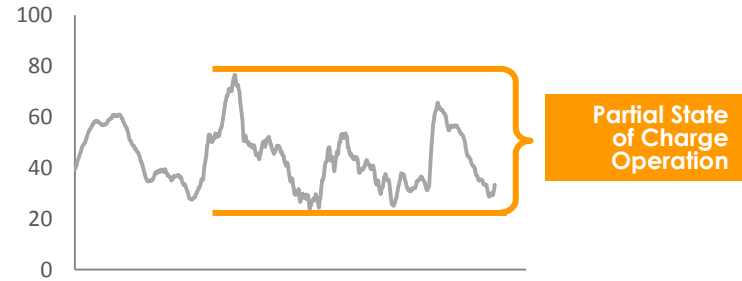

## Comparison of Efficiency vs State of Charge

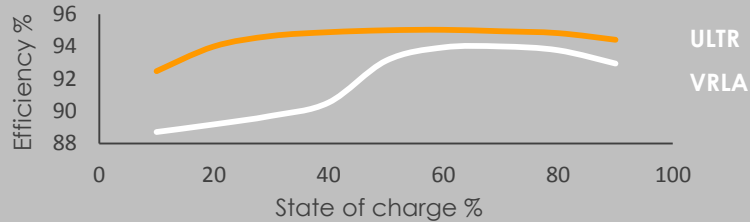

UltraBattery® is more efficient across range of SOC

## Capacity over time with PSoC use

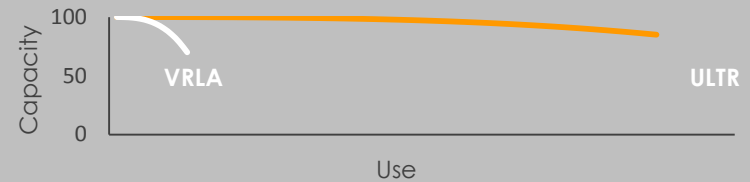

UltraBattery® can turn over much more energy during its life

# PJM Frequency Regulation

Regulation Services



***EAST PENN manufacturing co., inc.***



# Regulation Services on PJM



Fast Response Regulation Signal

Energy Store - PJM Regulation (5 Days) – Ordinary Regulation Signal



Energy Store - PJM Regulation (5 Days) – Fast Response Regulation Signal

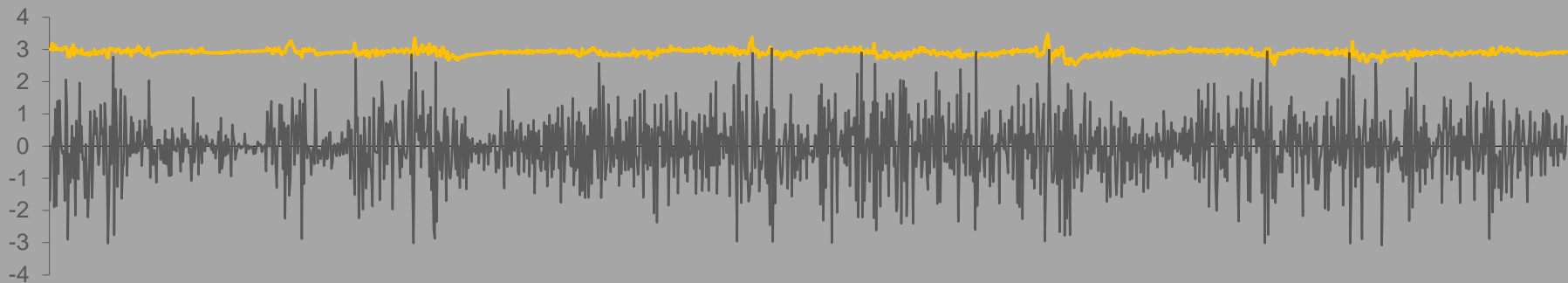



# Electrical Single Line Diagram



PJM Frequency Regulation Project

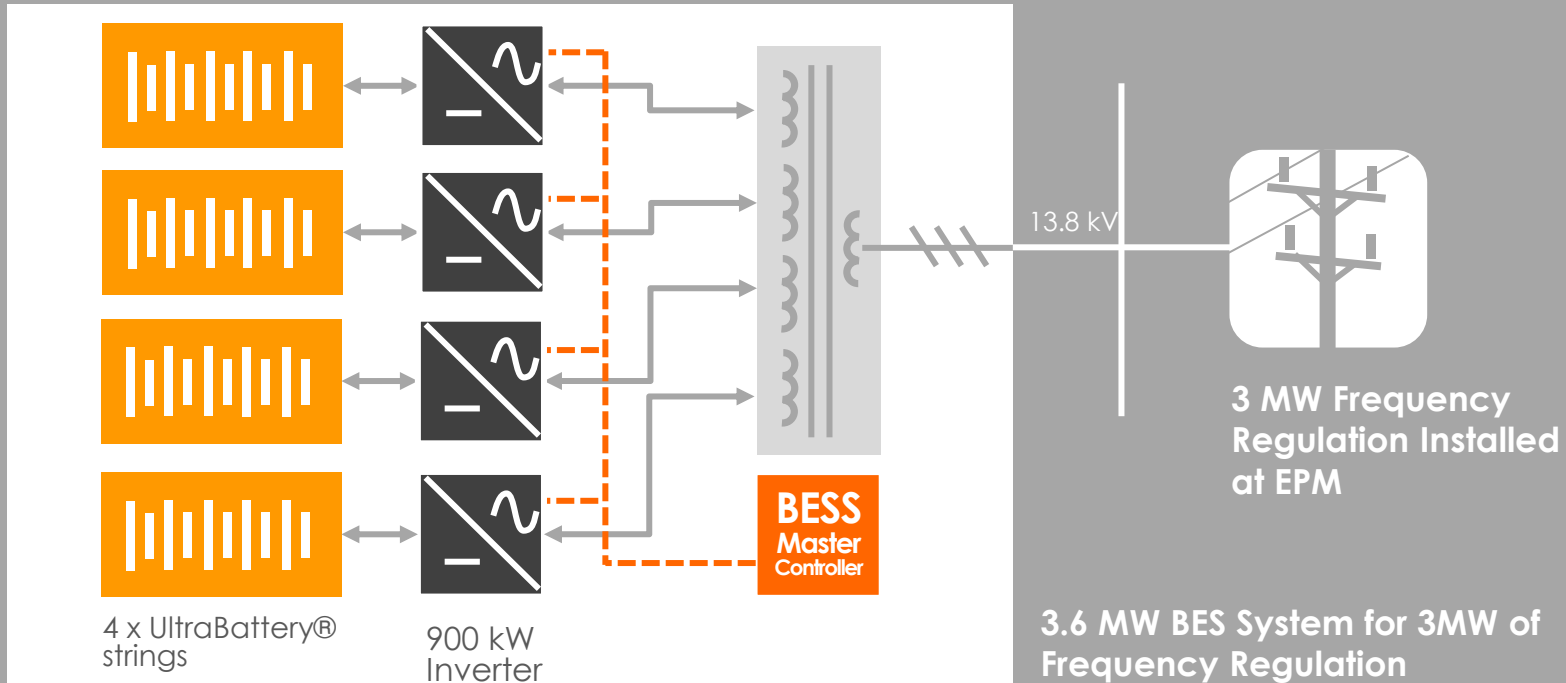

# Battery Management

and Monitoring System – PJM Frequency Regulation Project

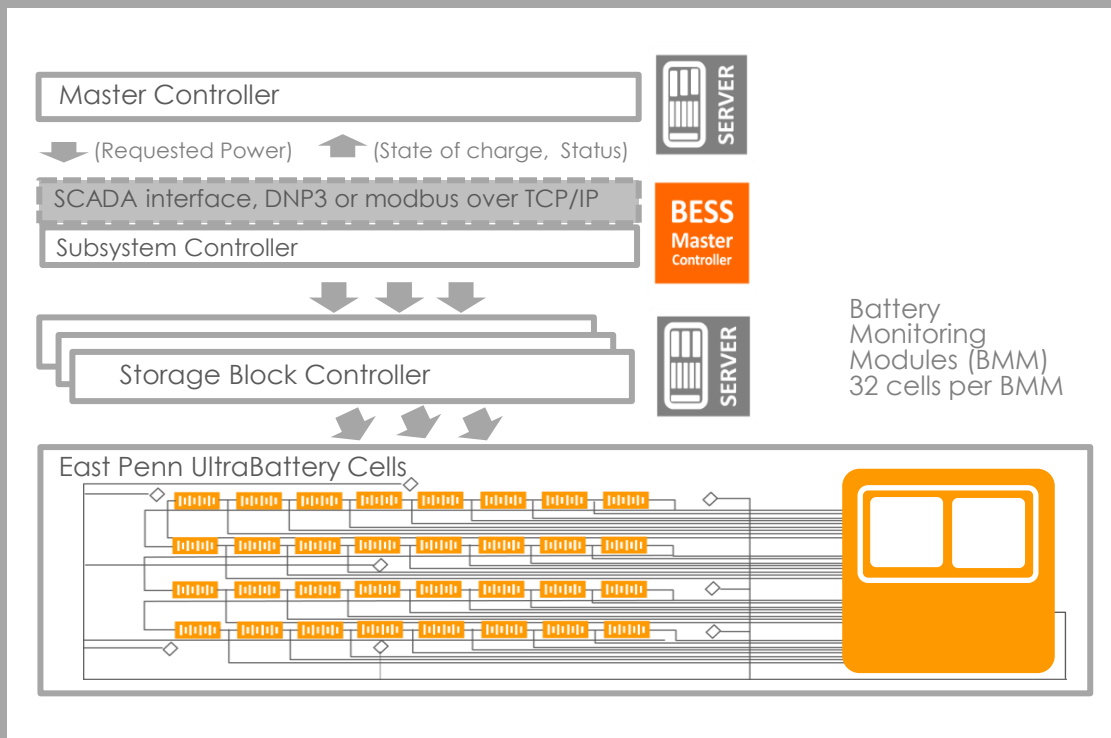

# Smoothing Renewables

Using UltraBattery® Technology



Variable  
Renewable  
Power

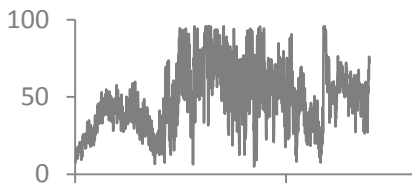
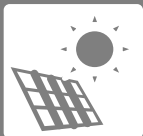

Renewable Output



Energy Store

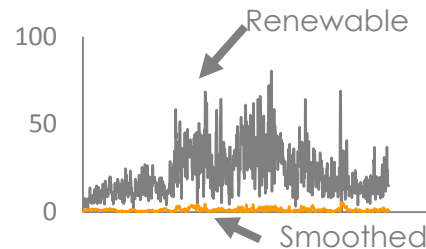
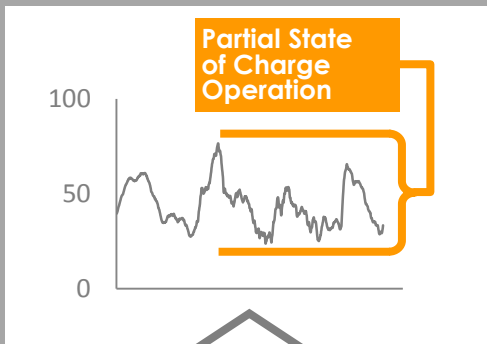

5 Minute Power Variability

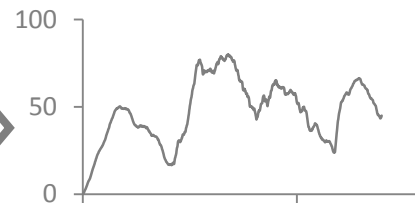

Smoothed Output

# PNM Prosperity Project

Solar Smoothing and Shifting (New Mexico, USA)



**EAST PENN** manufacturing co., inc.



# Hampton Wind Farm

Wind Smoothing (New South Wales, Australia)



**EAST PENN** manufacturing co., inc.





# Ecoults and UltraBattery®



The Energy Storage Solution of Choice

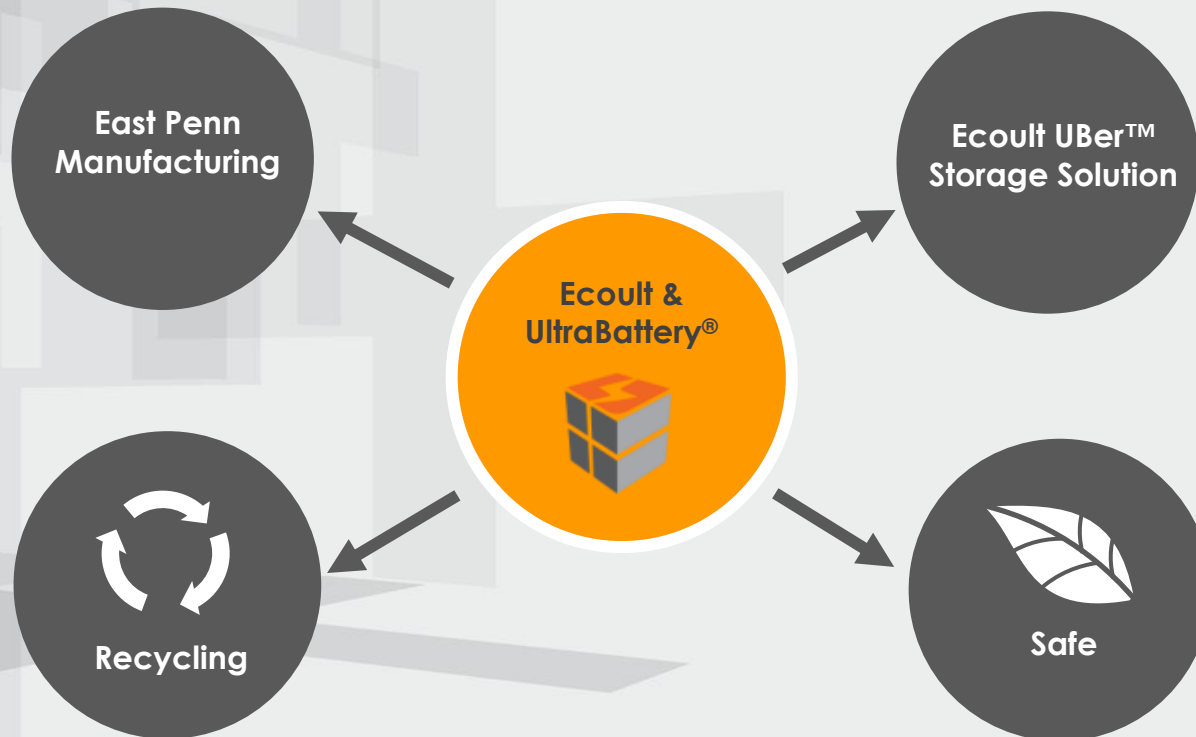

**EAST PENN** manufacturing co., inc.

